

# **Service Manual–P2222Hb/ P2222Ht**

**Version: 01**

**Date:2022/03/11**

## Content Index

<b>1. General Safety Instructions.....</b>	<b>3</b>
1.1 SAFETY: General Safety .....	3
1.2 SAFETY: General Power Safety .....	5
<b>2. Check Label behind monitor .....</b>	<b>6</b>
<b>3. Exploded view diagram with list of items (P2222Hb).....</b>	<b>7</b>
<b>4. Wiring connectivity diagram (P2222Hb).....</b>	<b>9</b>
<b>5. Disassembly and Assembly Procedures (P2222Hb).....</b>	<b>10</b>
5.1 Disassembly SOP (P2222Hb) .....	10
5.2 Assembly SOP (P2222Hb).....	14
<b>6. Exploded view diagram with list of items (P2222Ht).....</b>	<b>17</b>
<b>7. Wiring connectivity diagram (P2222Ht).....</b>	<b>18</b>
<b>8. Disassembly and Assembly Procedures (P2222Ht).....</b>	<b>19</b>
8.1 Disassembly Procedures (P2222Ht) .....	19
8.2 Assembly Procedures (P2222Ht) .....	22
<b>9. How to connect and disconnect power cable/ connectivity cable.....</b>	<b>26</b>
<b>10. Trouble shooting instructions.....</b>	<b>28</b>

## 1. General Safety Instructions

Use the following safety guidelines to help ensure your own personal safety and to help protect your equipment and working environment from potential damage.

**NOTE: In this section, equipment refers to monitors.**

### IMPORTANT NOTICE FOR USE IN HEALTHCARE ENVIRONMENTS:

Dell products are not medical devices and are not listed under UL or IEC 60601 (or equivalent). As a result, they must not be used within 6 feet of a patient or in a manner that directly or indirectly contacts a patient

#### 1.1 SAFETY: General Safety

**WARNING:** To prevent the spread of fire, keep candles or other open flames away from this product at all times.

#### When setting up the equipment for use:

- Place the equipment on a hard, level surface. Leave 10.2 cm (4 in) minimum of clearance on all vented sides of the computer to permit the airflow required for proper ventilation.
- Restricting airflow can damage the computer or cause a fire.
- Do not stack equipment or place equipment so close together that it is subject to recirculated or preheated air.
- **NOTE:** Review the weight limits referenced in your computer documentation before placing a monitor or other devices on top of your computer.
- Ensure that nothing rests on your equipment's cables and that the cables are not located where they can be stepped on or tripped over.
- Ensure that all cables are connected to the appropriate connectors. Some connectors have a similar appearance and may be easily confused (for example, do not plug a telephone cable into the network connector).
- Do not place your equipment in a closed-in wall unit or on a bed, sofa, or rug.
- Keep your device away from radiators and heat sources.
- Keep your equipment away from extremely hot or cold temperatures to ensure that it is used within the specified operating range.
- Do not push any objects into the air vents or openings of your equipment. Doing so can cause fire or electric shock by shorting out interior components.
- Avoid placing loose papers underneath your device. Do not place your device in a closed-in wall unit, or on a soft, fabric surface such as a bed, sofa, carpet, or a rug.

### **When operating your equipment:**

- Do not use your equipment in a wet environment, for example, near a bath tub, sink, or swimming pool or in a wet basement.
- Do not use AC powered equipment during an electrical storm. Battery powered devices may be used if all cables have been disconnected.
- Do not spill food or liquids on your equipment.
- Before you clean your equipment, disconnect it from the electrical outlet. Clean your device with a soft cloth dampened with water. Do not use liquids or aerosol cleaners, which may contain flammable substances.
- Clean the monitor display with a soft, clean cloth and water. Apply the water to the cloth, then stroke the cloth across the display in one direction, moving from the top of the display to the bottom. Remove moisture from the display quickly and keep the display dry.
- Long-term exposure to moisture can damage the display. Do not use a commercial window cleaner to clean your display.
- If your equipment does not operate normally - in particular, if there are any unusual sounds or smells coming from it - unplug it immediately and contact an authorized dealer or service center.

### **Protecting Against Electrostatic Discharge**

Electrostatic discharge (ESD) events can harm electronic components inside your equipment. Under certain conditions, ESD may build up on your body or an object, such as a peripheral, and then discharge into another object, such as your computer. To prevent ESD damage, you should discharge static electricity from your body before you interact with any of your equipment's internal electronic components, such as a memory module. You can protect against ESD by touching a metal grounded object (such as an unpainted metal surface on your computer's I/O panel) before you interact with anything electronic. When connecting a peripheral (including handheld digital assistants) to your equipment, you should always ground both yourself and the peripheral before connecting it. In addition, as you work inside the equipment, periodically discharge any static charge your body may have accumulated.

### **You can also take the following steps to prevent damage from electrostatic discharge:**

- When unpacking a static-sensitive component from its shipping carton, do not remove the component from the antistatic packing material until you are ready to install the component. Just before un wrapping the antistatic package, be sure to discharge static electricity from your body.
- When transporting a sensitive component, first place it in an antistatic container or packaging.
- Handle all electrostatic sensitive components in a static-safe area. If possible, use antistatic floor pads and work bench pads.



## 1.2 SAFETY: General Power Safety

Observe the following guidelines when connecting your equipment to a power source:

- Check the voltage rating before you connect the equipment to an electrical outlet to ensure that the required voltage and frequency match the available power source.
- Do not plug the equipment power cables into an electrical outlet if the power cable is damaged
- Norway and Sweden: If this product is provided with a 3-prong power cable, connect the power cable to a grounded electrical outlet only.
- If you use an extension power cable, ensure that the total ampere rating of the products plugged in to the extension power cable does not exceed the ampere rating of the extension cable.
- If you must use an extension cable or power strip, ensure the extension cable or power strip is connected to a wall power outlet and not to another extension cable or power strip. The extension cable or power strip must be designed for grounded plugs and plugged into a grounded wall outlet.
- If you are using a multiple-outlet power strip, use caution when plugging the power cable into the power strip. Some power strips may allow you to insert a plug incorrectly. Incorrect insertion of the power plug could result in permanent damage to your equipment, as well as risk of electric shock and/or fire. Ensure that the ground prong of the power plug is inserted into the mating ground contact of the power strip.
- Be sure to grasp the plug, not the cable, when disconnecting equipment from an electric socket.

### If your equipment uses an AC adapter:

- Use only the Dell provided AC adapter approved for use with this device. Use of another AC adapter may cause a fire or explosion.
- NOTE: Refer to your system rating label for information on the proper adapter model approved for use with your device.
- Place the AC adapter in a ventilated area, such as a desk top or on the floor, when you use it to run the computer or to charge the battery. Do not cover the AC adapter with papers or other items that will reduce cooling; also, do not use the AC adapter inside a carrying case.
- The AC adapter may become hot during normal operation of your computer. Use care when handling the adapter during or immediately after operation.
- It is recommended that you lay the adapter on the floor or desk so that the green light is visible. This will alert you if the adapter should accidentally go off due to external effects. If for any reason the green light goes off, disconnect the AC power cord from the wall for a period of ten seconds, and then reconnect the power cord.
- Japan Only: Use only the Dell-provided AC power cable with the AC adapter. Use of any other power cable may damage the device or AC adapter or may present risk of fire or electric shock.

## 2. Check Label behind monitor

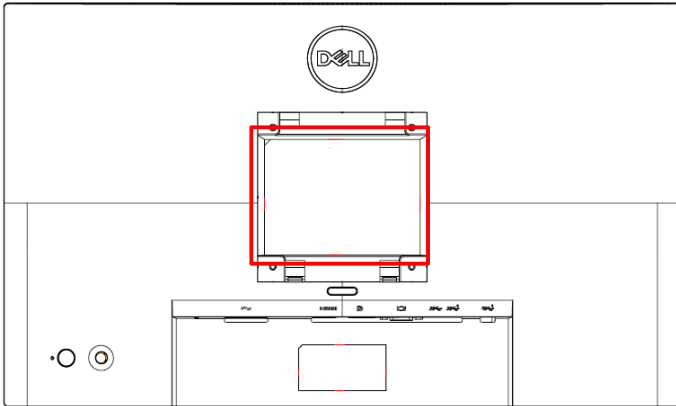

### 2.1 P2222Hb (Please follow Instruction for P2222Hb)



### 2.2 P2222Ht (Please follow instruction for P2222Ht, start from section 6)



### 3. Exploded view diagram with list of items (P2222Hb)

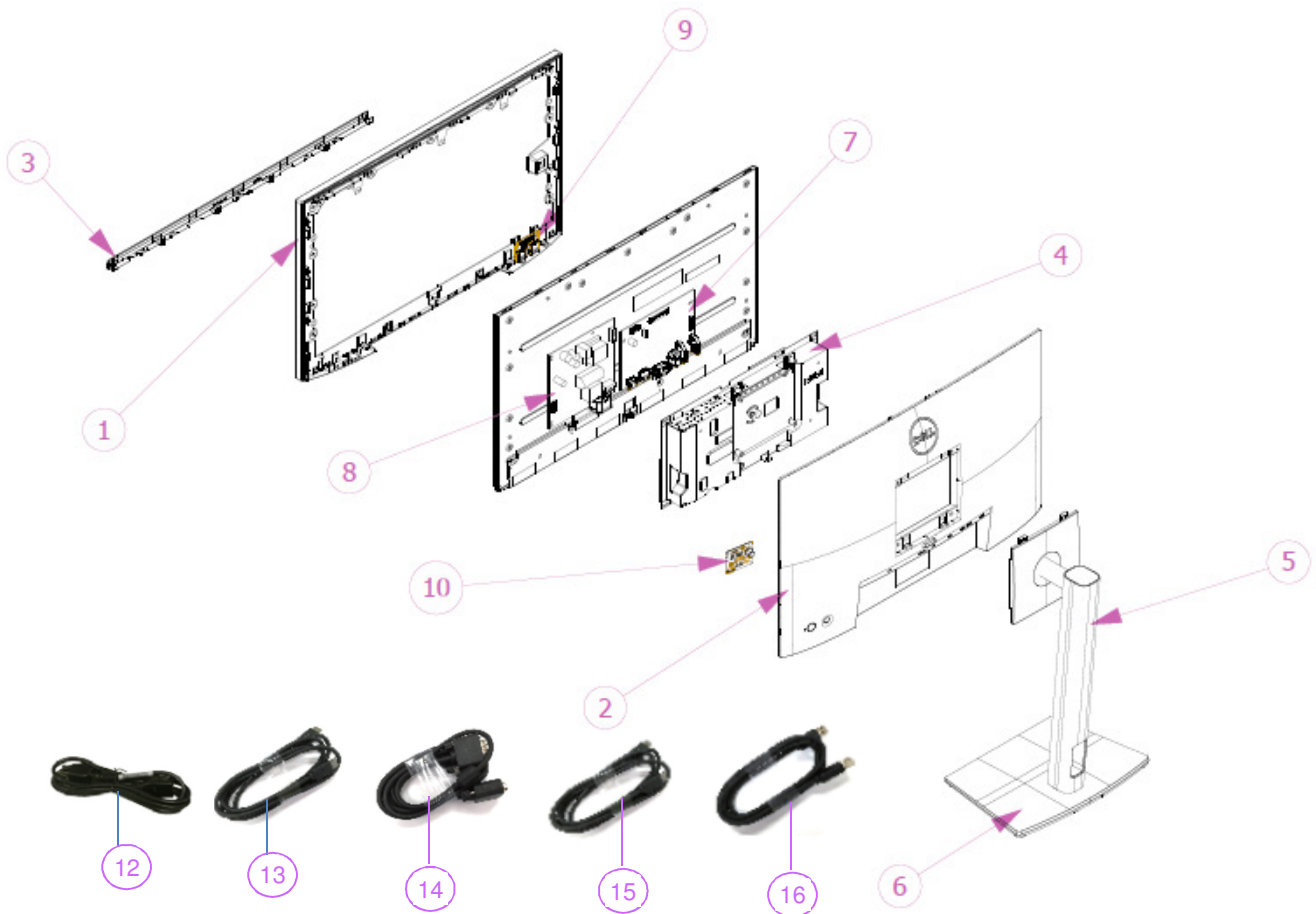

Item	Description	Q'ty	Remark
1	ASSY MF	1	For EMEA Only, not for other regions
2	ASSY RC	1	
3	ASSY CHIN	1	
4	ASSY SHD	1	
5	ASSY CLMN	1	
6	ASSY BASE	1	
7	PCBA I/F BD	1	
8	PCBA SPS BD	1	
9	PCBA CTRL BD	1	
10	PCBA USB BD	1	
11	Panel	1	
12	Power cable	1	See "NOTE"
13	DisplayPort 1.2 cable	1	See "NOTE"
14	VGA cable	1	See "NOTE"
15	HDMI 1.4 cable	1	See "NOTE"
16	USB 3.0 upstream cable	1	See "NOTE"

**NOTE:**

For replacement of power cord, connectivity cable and external power supply (if applicable), contact Dell:

1. Go to <https://www.dell.com/support>.
2. Verify your country or region in the Choose A Country/Region drop-down menu at the bottom-right corner of the page.
3. Click Contact Us next to the country dropdown.
4. Select the appropriate service or support link based on your need.
5. Choose the method of contacting Dell that is convenient for you

#### 4. Wiring connectivity diagram (P2222Hb)

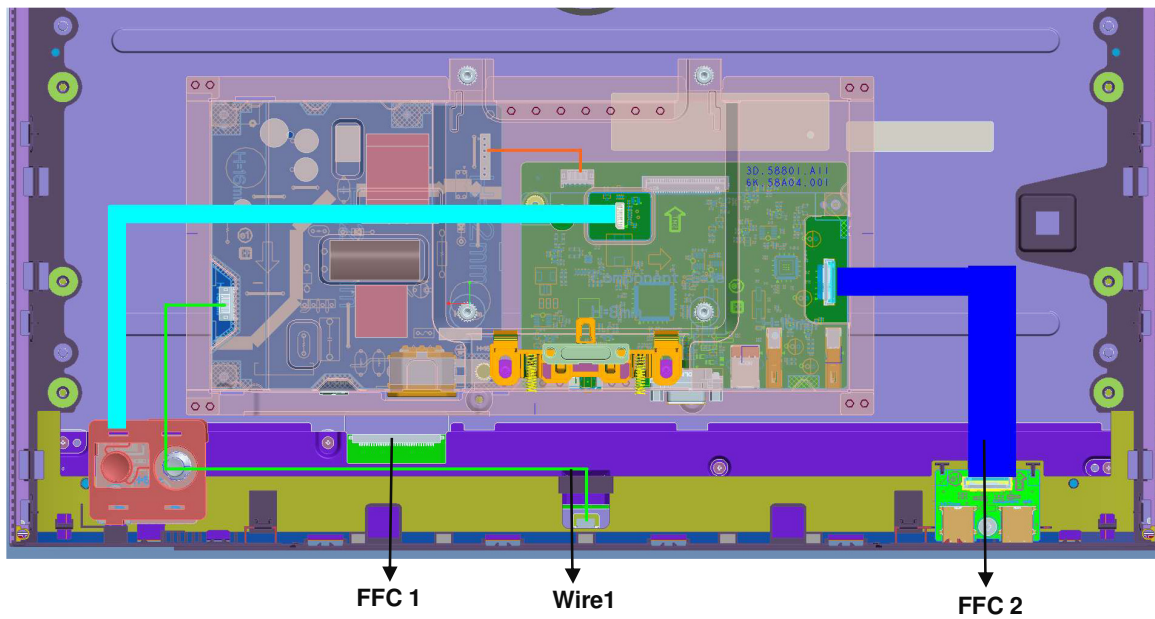

## 5. Disassembly and Assembly Procedures (P2222Hb)

**NOTE:**

This “Disassembly and Assembly Procedures” is for EMEA only, not for other regions. Please note that Dell will deem warranty void if any disassembly is done on the monitors.

### 5.1 Disassembly SOP (P2222Hb)

Preparation before disassembly

1. Clean the room for work
2. Identify the area for material
3. Prepare the implement, equipment, materials as bellow :
  - 1) Working table
  - 2) Philips-head screwdriver
  - 3) Hex-head screwdriver
  - 4) Gloves
  - 5) Cleaning cloth
  - 6) ESD protection

Item	Picture	Operation	Tool	Notes
1		<p>To remove the stand:</p> <ol style="list-style-type: none"> <li>1. Place the monitor on a soft cloth or cushion at the edge of the desk.</li> <li>2. Press and hold the stand release button at the back of the display.</li> <li>3. Lift the stand assembly up and away from the monitor.</li> </ol>		

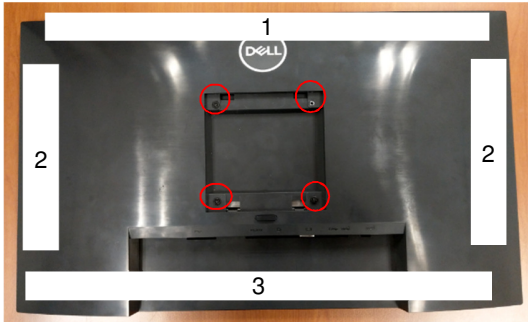
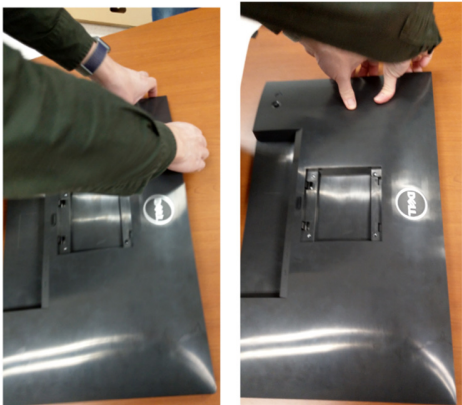
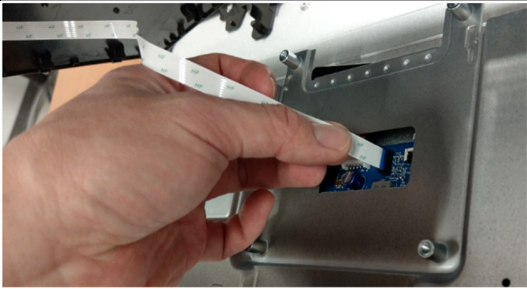
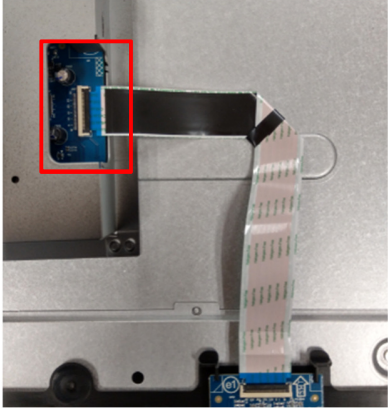
<p>2</p>	 	<ol style="list-style-type: none"> <li>1. Unlock 4 RC screws</li> <li>2. Disassemble Rear Cover from Middle Frame according to the sequence shown in the picture</li> </ol>	<p>Philips-head screwdriver</p> <p>Torsion of RC screw: 9±1Kgf</p>	
<p>3</p>		<ol style="list-style-type: none"> <li>1. Pull out CTRL FFC from I/F BD to take off Rear Cover</li> </ol>		
<p>4</p>		<ol style="list-style-type: none"> <li>1. Pull out USB FFC from I/F BD</li> </ol>		

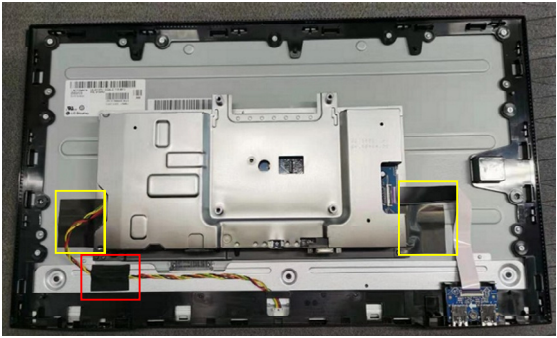
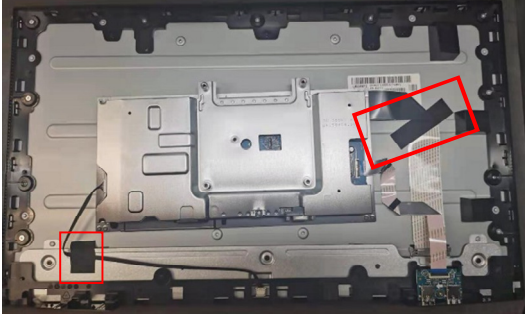
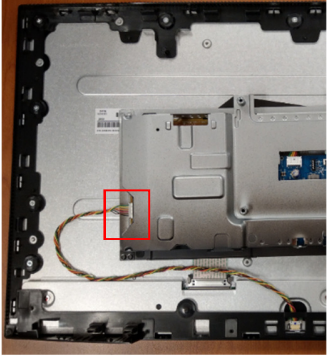
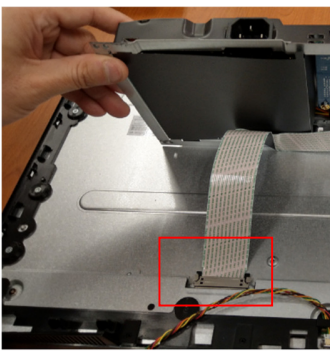

<p>5</p>	<p>Other Panel</p>  <p>LGD Panel</p> 	<ol style="list-style-type: none"> <li>1. Tear off adhesive tape on Backlight Wire</li> <li>2. Tear off adhesive tape on LVDS Cable (Note: Only for LG panel)</li> <li>3. Tear off two tapes to disassemble Main SHD from panel</li> </ol>		
<p>6</p>	 	<ol style="list-style-type: none"> <li>1. Pull out Backlight Wire from SPS BD</li> <li>2. Pull out LVDS cable and take off Main SHD from panel</li> </ol>		

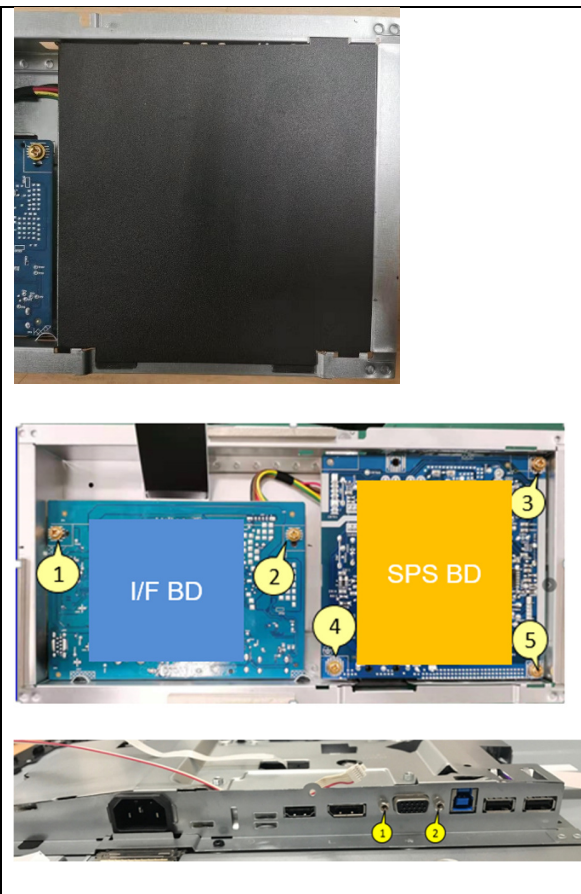
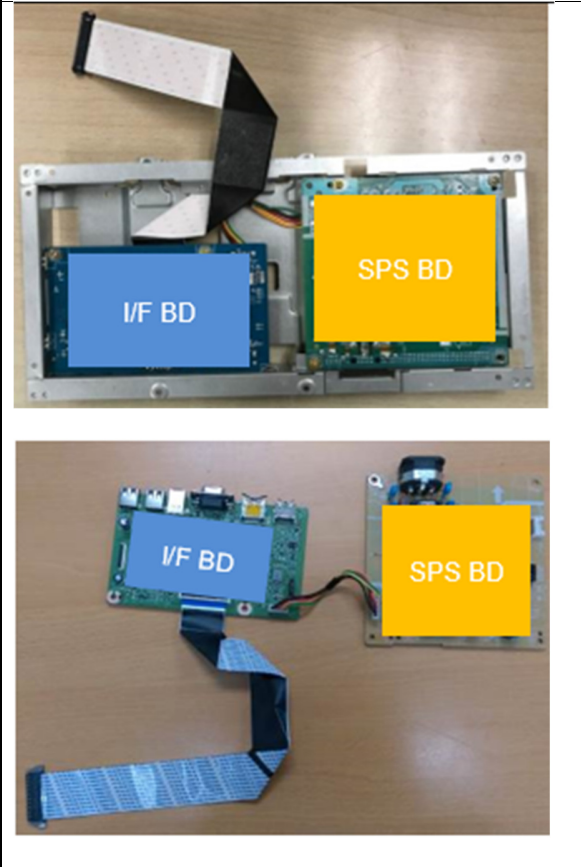

<p>7</p>		<ol style="list-style-type: none"> <li>1. Disassemble Mylar from Main SHD</li> <li>2. Unlock 5 PCB screws and 2 hex screws</li> </ol>	<ol style="list-style-type: none"> <li>1. Philips-head screwdriver Torsion of PCB screw: <math>8.5 \pm 1 \text{ kgf}</math></li> <li>2. Hex-head screwdriver Torsion of hex screw: <math>5 \pm 0.6 \text{ Kg}</math></li> </ol>	
<p>8</p>		<ol style="list-style-type: none"> <li>1. Take out I/F BD and SPS BD from Main SHD</li> <li>2. Pull out LVDS cable and SPS BD cable from I/F BD</li> </ol>		



## 5.2 Assembly SOP (P2222Hb)

### Preparation before assembly

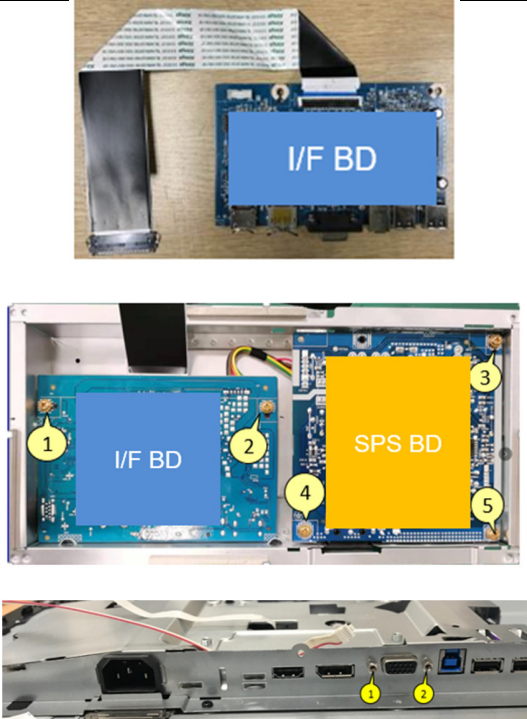
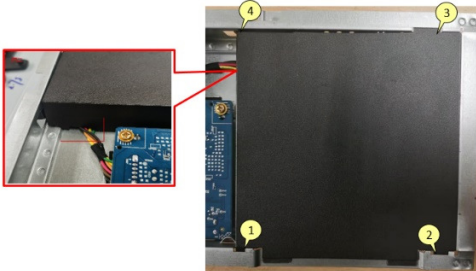
1. Clean the room for work
2. Identify the area for material
3. Prepare the implement, equipment, materials as bellow:
  - 1) Working table
  - 2) Philips-head screwdriver
  - 3) Hex-head screwdriver
  - 4) Gloves
  - 5) Cleaning cloth
  - 6) ESD protection

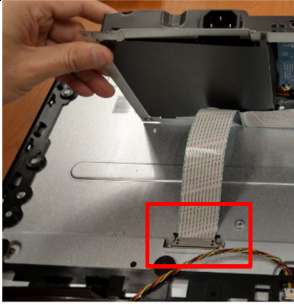
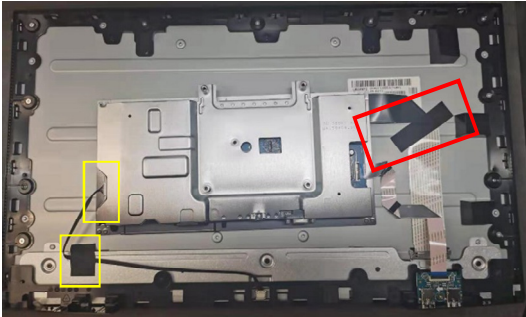
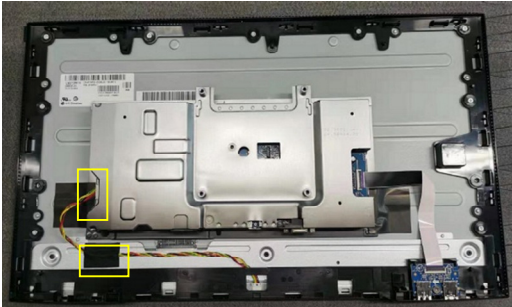
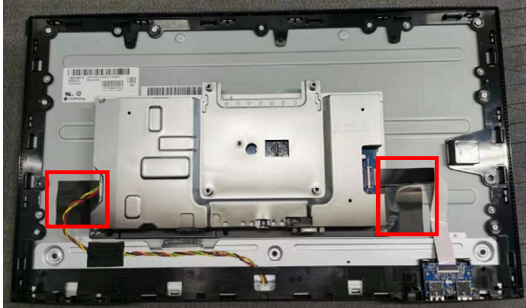
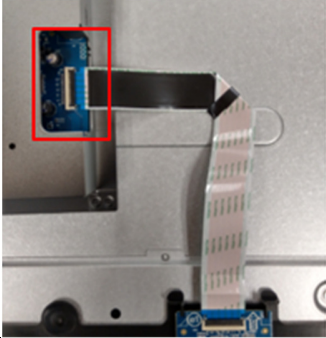
Item	Picture	Operation	Tools	Notes
1		<ol style="list-style-type: none"> <li>1. Assemble SPS BD in Main SHD</li> <li>2. Insert the LVDS cable into I/F BD</li> <li>3. Insert SPS BD cable into I/F BD and then assemble I/F BD into Main SHD</li> <li>4. Lock 5 PCB screws and 2 hex screws</li> </ol>	<ol style="list-style-type: none"> <li>1. Philips-head screwdriver  Torsion of PCB screw: 8.5±1kgf</li> <li>2. Hex-head screwdriver  Torsion of hex screw: 5±0.6Kgf</li> </ol>	
2		<ol style="list-style-type: none"> <li>1. Assemble Mylar ( Paste Mylar on Main SHD like the picture showed )</li> </ol>		

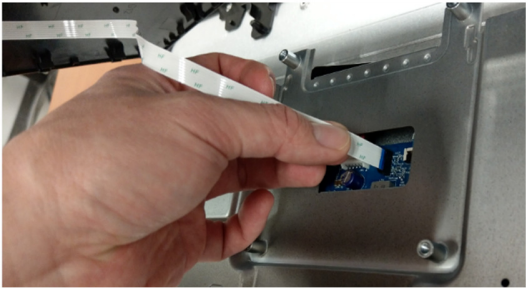
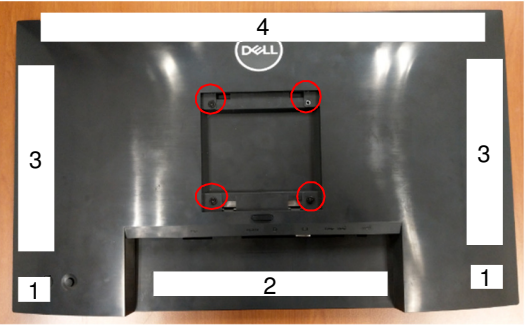
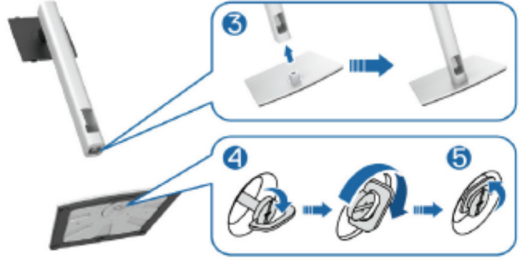
<p>3</p>	 <p>LGD Panel</p>  <p>Other Panel</p> 	<ol style="list-style-type: none"> <li>1. Insert LVDS cable into Panel</li> <li>2. Paste acetate tape to fix LVDS cable on panel (Note: Only for LG panel)</li> <li>3. Insert Backlight Wire into SPS BD and paste 1 tape to fix wire</li> </ol>		
<p>4</p>		<ol style="list-style-type: none"> <li>1. Place Main SHD on panel and paste 2 tapes to fix Main SHD</li> </ol>		
<p>5</p>		<ol style="list-style-type: none"> <li>1. Insert USB FFC to USB BD and I/F BD</li> </ol>		

<p>6</p>	 	<ol style="list-style-type: none"> <li>1. Insert CTRL FFC into I/F BD</li> <li>2. Assemble Rear Cover with Middle Frame according to the sequence shown in the picture</li> <li>3. Lock 4 RC screws</li> </ol>	<p>Philips-head screwdriver</p> <p>Torsion of RC screw: 9±1Kgf</p>	
<p>7</p>		<ol style="list-style-type: none"> <li>1. Assemble Stand       <ol style="list-style-type: none"> <li>a. Insert the stand base blocks fully into the stand slot.</li> <li>b. Lift the screw handle and turn the screw clockwise.</li> <li>c. After fully tightening the screw, fold the screw handle flat within the recess.</li> </ol> </li> </ol>		
<p>8</p>		<ol style="list-style-type: none"> <li>1. Attach the stand assembly to the display.       <ol style="list-style-type: none"> <li>a. Fit the two tabs on the upper part of the stand to the groove on the back of the display.</li> <li>b. Press the stand down till it snaps into place.</li> </ol> </li> </ol>		



## 6. Exploded view diagram with list of items (P2222Ht)

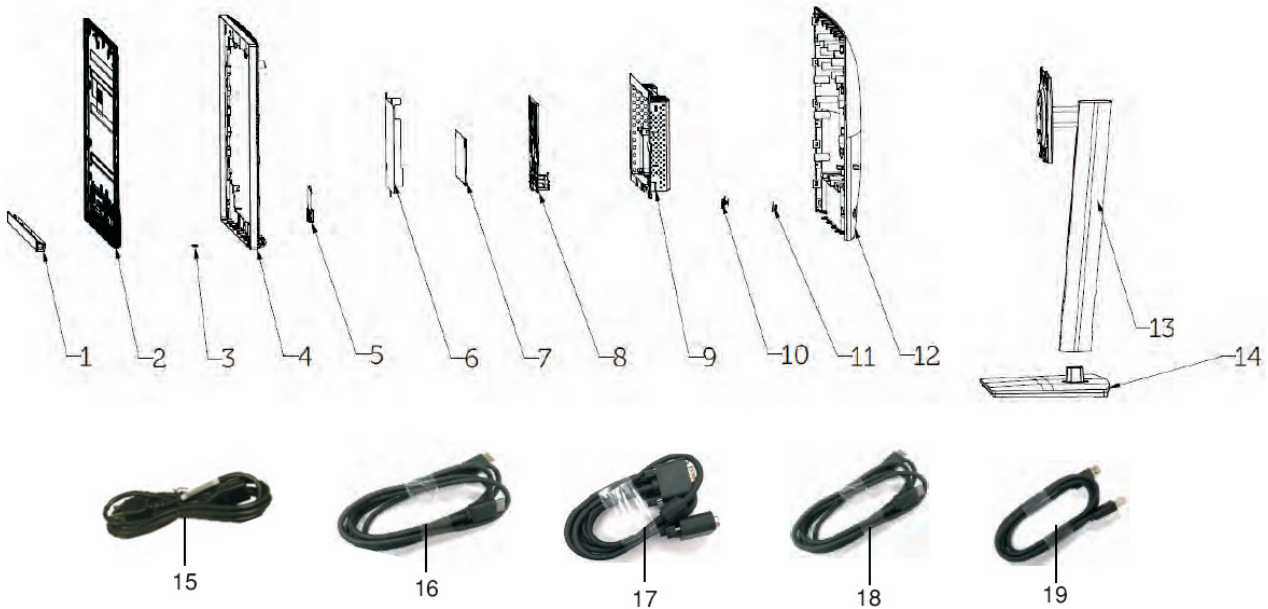

Item	Description	Q'ty	Remark
1	Front trim	1	For EMEA Only, not for other regions
2	Panel	1	
3	LED BD	1	
4	ASSY Middle Frame	1	
5	USB BD	1	
6	Panel Mylar	1	
7	Interface BD	1	
8	Power BD	1	
9	Main bracket	1	
10	Key BD	1	
11	Joystick button	1	
12	Back cover	1	
13	Riser ASSY	1	
14	Base ASSY	1	
15	Power cable	1	See "NOTE"
16	DisplayPort 1.2 cable	1	See "NOTE"
17	VGA cable (Japan Only)	1	See "NOTE"
18	HDMI 1.4 cable (Brazil Only)	1	See "NOTE"
19	USB 3.0 upstream cable	1	See "NOTE"

### NOTE:

For replacement of power cord, connectivity cable and external power supply (if applicable), contact Dell:

1. Go to <https://www.dell.com/support>.
2. Verify your country or region in the Choose A Country/Region drop-down menu at the bottom-right corner of the page.
3. Click Contact Us next to the country dropdown.
4. Select the appropriate service or support link based on your need.
5. Choose the method of contacting Dell that is convenient for you.

## 7. Wiring connectivity diagram (P2222Ht)

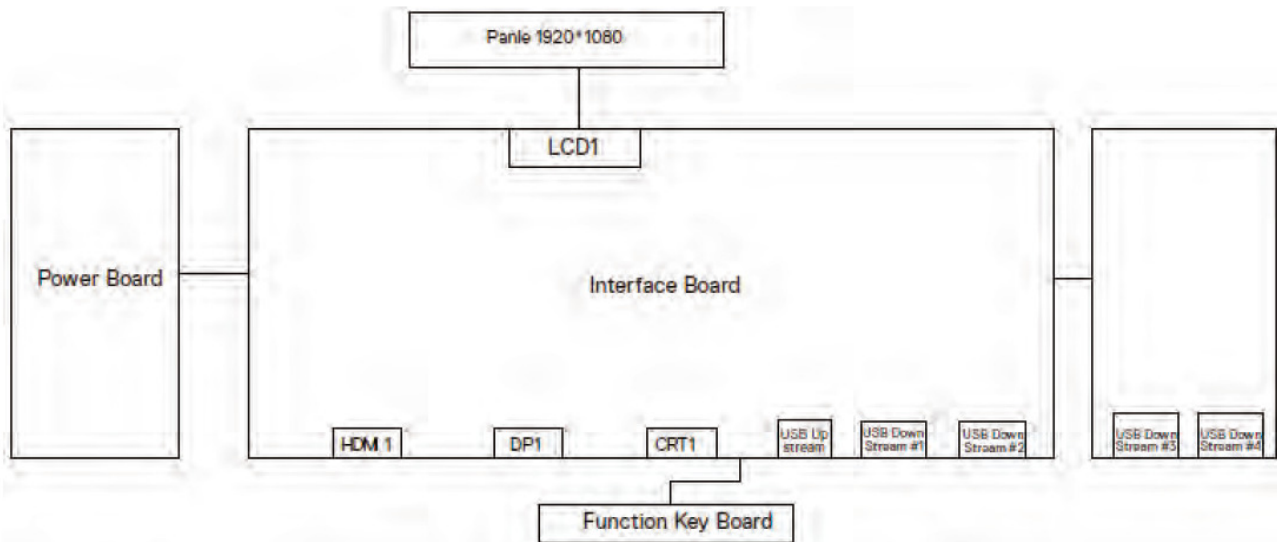

## 8. Disassembly and Assembly Procedures (P2222Ht)

### 8.1 Disassembly Procedures (P2222Ht)

**NOTE:**

This "Disassembly and Assembly Procedures" is for EMEA only, not for other regions. Please note that Dell will deem warranty void if any disassembly is done on the monitors.

**Tool Required:**

List the type and size of the tools that would typically can be used to disassemble the product to a point where components and materials requiring selective treatment can be removed.

**Tool Description:**

- Screwdriver(Phillip head) #1
- Screwdriver(Phillip head) #2
- Penknife
- Soldering iron and absorber

5.1 Disassembly Procedures:

Remove the monitor stand base:

S1

1. Place the monitor on a soft cloth or cushion.
2. Press and hold the stand-release button.
3. Lift the stand up and away from the monitor.



S2

Use a Philips-head screwdriver to remove four screws for unlocking mechanisms.

(No.1~4 screw size=M4x10; Torque=12±0.5kgfxcm)

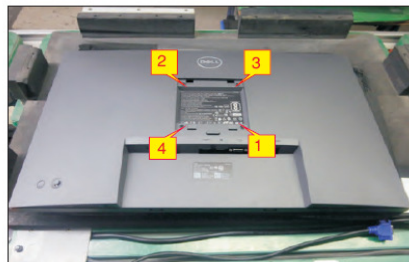

Wedge your fingers between the rear cover and the middle bezel on the corners of the top side of the monitor to release the rear cover, then use one hand to press the middle bezel, the other hand to pull up carefully the rear cover in order of arrow preference for unlocking mechanisms of rear cover.

S3

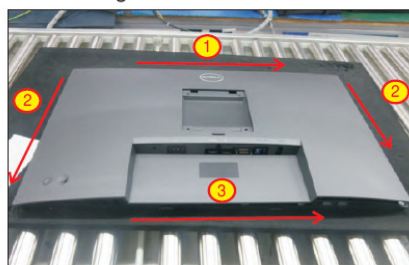

S4

Lift the rear cover up carefully. Disconnect the key cable and USB FFC cable from the connectors of the interface board, and then remove the rear cover.

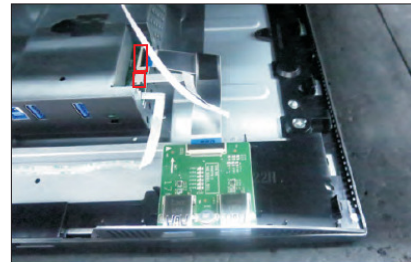

S5

Use a Philips-head screwdriver to remove 2pcs screws for unlocking the joystick key board unit, then tear off the tapes and release the USB board.

(No.1~2 screw size=M2x3.3, Torque=1±0.2kgfxcm)

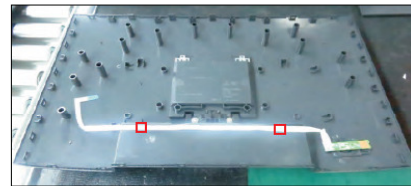

S6

Use a Philips-head screwdriver to remove one screw for unlocking the USB board unit, then release the USB board unit and put it aside.

(No.1 screw size=M3x6, Torque=4±0.5kgfxcm)

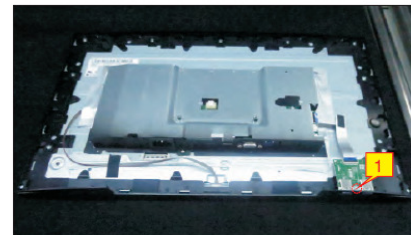

S7

Tear off 2pcs aluminium foils for unfixing the bracket. Tear off 1pcs acetate tape, and then release the panel lamp cable from the hook of the middle bezel.

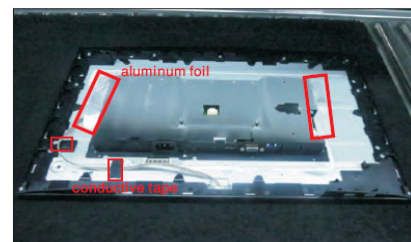



S8

Use a Philips-head screwdriver to remove 11 pcs screws for unlocking the middle bezel with the panel.  
(No.1~9 screw size=M3x4, Torque=5±0.5kgfxcM;  
No.10~11 screw size=M1.6x1.7, Torque=1±0.2kgfxcM)

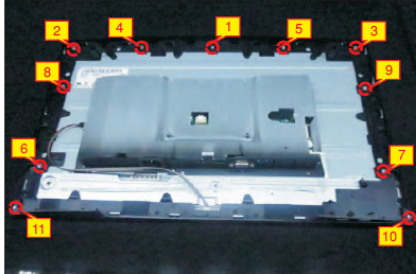

S9

Disconnect the LED cable from the connector, then release the LED cable by tearing off 2 pcs tapes.

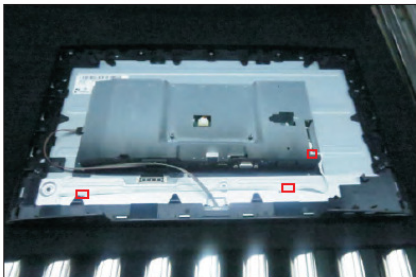

S10

Take away the middle bezel, and put it on a fixture, then tear off the mylar tape for releasing the LED board.

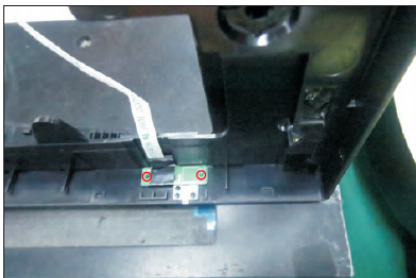
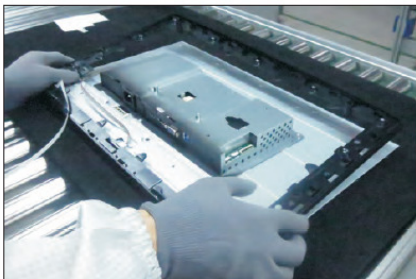

S11

Lift up the panel with the bracket for releasing the front bezel away from the panel. Use a Philips-head screwdriver to remove one screw for unlocking the bracket with panel.  
(No.1 screw size=M3x0.5x3, Torque=4±0.5kgfxcM)

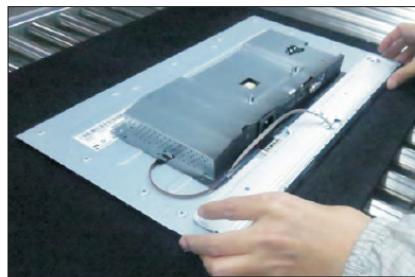
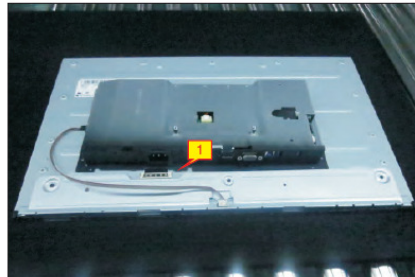

S12

Put the panel module on a protective cushion, then disconnect the panel lamp cable from the connector of panel module, then unplug the LVDS cable from the connector of the panel module.

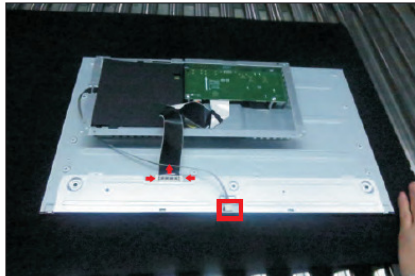

S13

Take away the bracket chassis module and then put the bracket chassis module on a protective cushion.

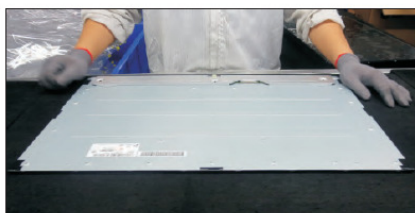
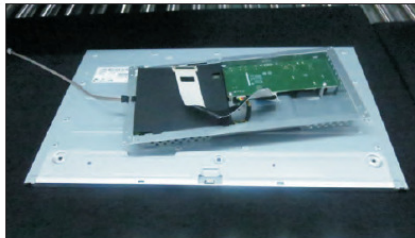



- S14 Remove the black Mylar from the hooks of the bracket as the picture below shown.

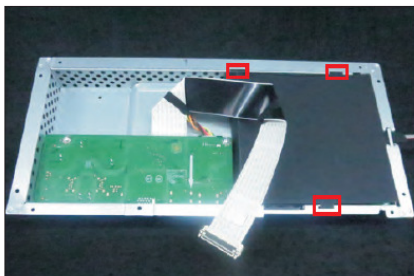

- S15 Use a Hex-head screwdriver to remove two screws for unlocking the D-Sub connector.  
(No.1~2 screws size=M3x8, Torque=6±0.5kgfxcM)

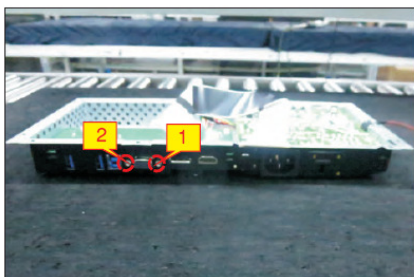

- S16 Use a Philips-head screwdriver to remove 5pcs screws for unlocking the power board and interface board, and then release all the cables from the hooks.  
(No.1~4 screw size=M3x7.5, Torque=6±0.5kgfxcM;  
No.5 screw size=M4x8, Torque=6±0.5kgfxcM)

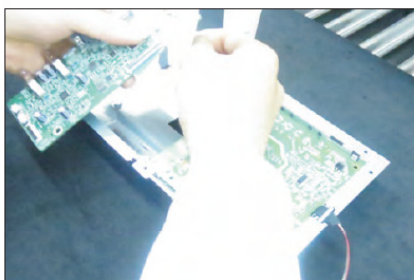
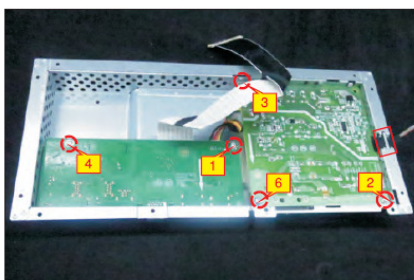

- S17 Remove the interface board and power board from the bracket chassis module carefully, and disconnect all the cables.

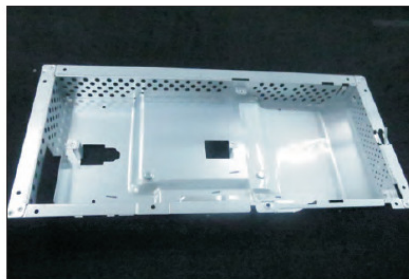

## 8.2 Assembly Procedures (P2222Ht)

S1

Place a bracket chassis base on a protective cushion.

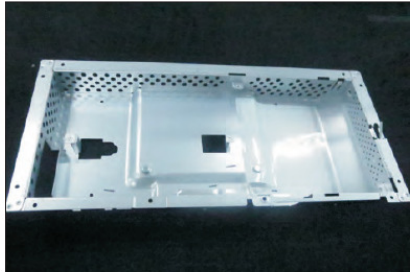

S2

Turn over a power board and put the power board into the bracket chassis, locate the panel power cable into the hook of the bracket chassis.

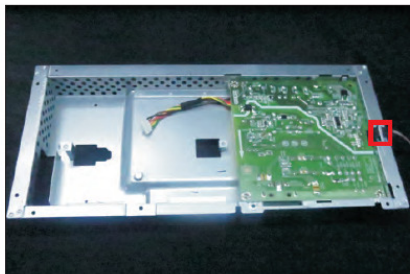

S3

Take a interface board, connect a LVDS cable to the connector of the interface board, then connect the cable of the power board to the connector of the interface board. Turn over the interface board and locate it into the bracket. Use a Philips-head screwdriver to tighten 5pcs screws for locking the power board and interface board.

(No.1~4 screw size=M3x7.5, Torque=6±0.5kgfxcM;  
No.5 screw size=M4x8, Torque=6±0.5kgfxcM)

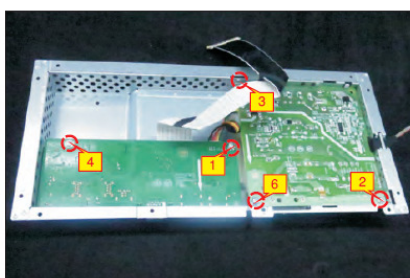
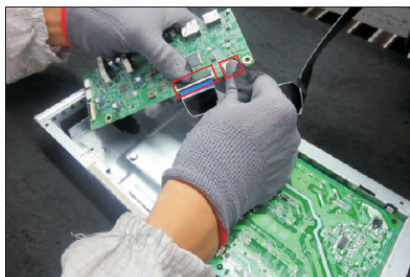

S4

Use a Hex-head screwdriver to tighten 2pcs screws for locking the D-Sub connector.

(No.1~2 screw size=M3x8, Torque=6±0.5kgfxcM)

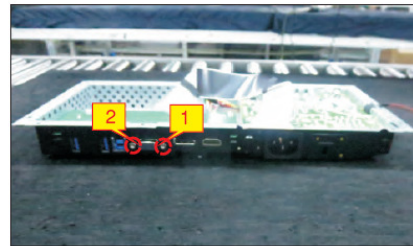

S5

Take a mylar to insert the hooks of the bracket to cover the power board.

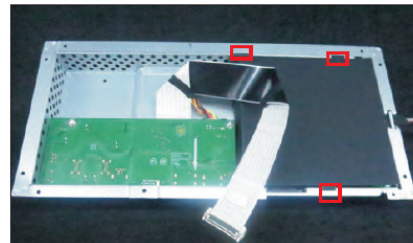

S6

Panel preparation: Examine the panel surface according to inspection criteria. Turn over the panel to place the screen faced down for later assembling.

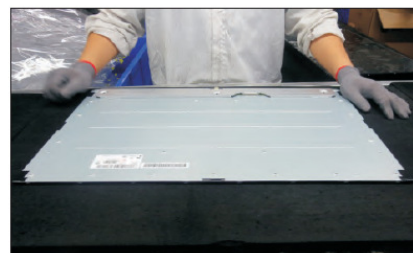

S7

Put the bracket chassis module on the back of LCD module, then connect LVDS cable and panel lamp cable to the connectors of the panel module.





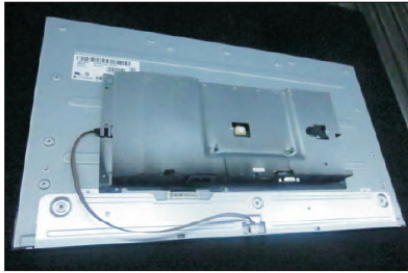

S8

Take a front bezel, then lift up the panel with bracket and assemble the front bezel with the unit. Use a Philips-head screwdriver to tighten 1pcs for locking the bracket with panel module.

(No.1 screw size=M3x0.5x3, Torque=4±0.5kgfxcM)

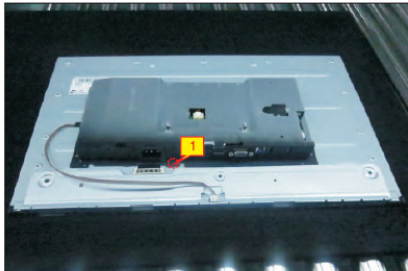
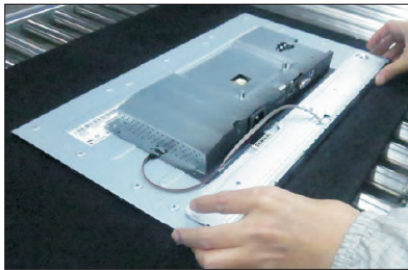

S9

Take 1pcs LED board and 1pcs middle bezel, then put the middle bezel into a fixture jip to fix the middle bezel. Tear off the release paper on the back of the board, and then paste the LED board on the correct position of the middle bezel, then paste 1pcs mylar tape to cover the LED board.

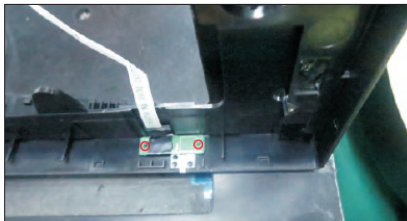

S10

Assemble the middle bezel with the front bezel and panel module, then adjust the middle bezel for two parts firmly attachment.

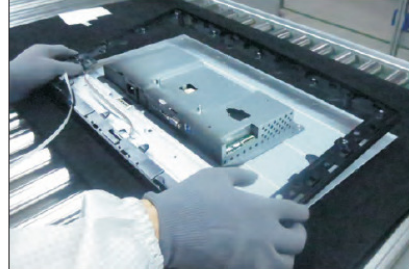

S11

Fix the LED cable with 2pcs tapes on the middle bezel by tearing off papers., and then connect the LED cable to the connector of the interface board.

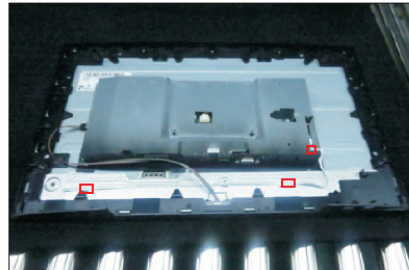

S12

Use a Philips-head screwdriver to tighten 11pcs screws for locking the middle bezel with the panel.

(No.1~9 screw size=M3x4, Torque=5±0.5kgfxcM;

No.10~11 screw size=M1.6x1.7, Torque=1±0.2kgfxcM)

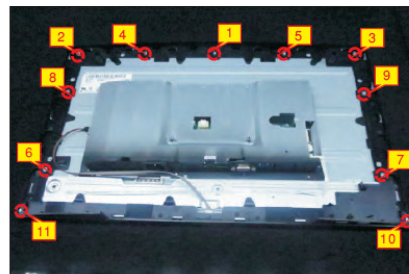

S13

Use a fixture jip to fix the bracket chassis, then paste 2pcs aluminum foil on the specific position to fix the bracket chassis module. Locate the panel lamp into the hook of the middle bezel, then fix the panel lamp cable with 1pcs acetate tape as the picture below shown.

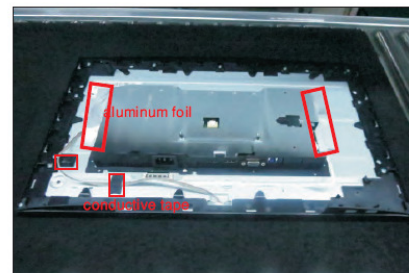

S14

Take 1pcs USB board and a connect cable. Connect the cable to the USB board, then paste 1pcs conductive foam on the back of the board. Locate the USB board into the hook of the middle bezel. Use a Philips-head screwdriver to tighten one screw for locking the USB unit with middle bezel.

(No.1 screw size=M3x6, Torque=4±0.5kgfcm)

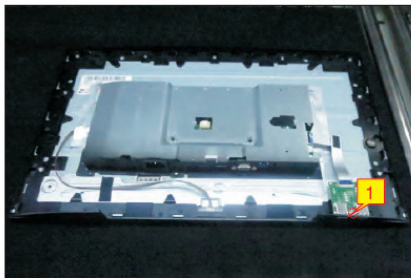
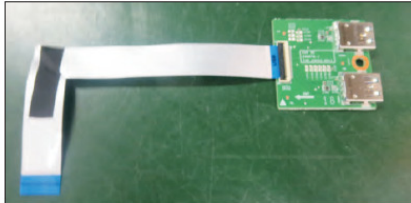

Take 1pcs joystick key, 1pcs joystick board and 1pcs rear cover, then assemble the joystick key with board. Locate the joystick board to the correct position of the rear cover, then use a Philips-head screwdriver to tighten 2pcs screws for locking the joystick board with rear cover, then fix the key cable with 2pcs tapes.

(No.1~2 screw size=M2x3.3, Torque=1±0.2kgfcm)

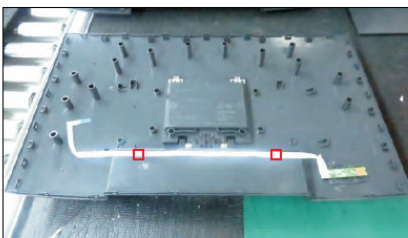
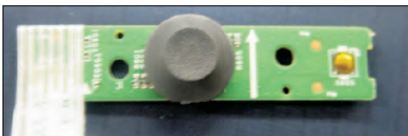
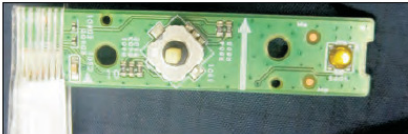

S15

S16

Move the assembled rear cover close to the panel unit, then connect the key cable and USB FFC cable to the connectors of interface board. Put down the rear cover and push the rear cover on the positions marked as the picture below shown for mechanisms engagement.

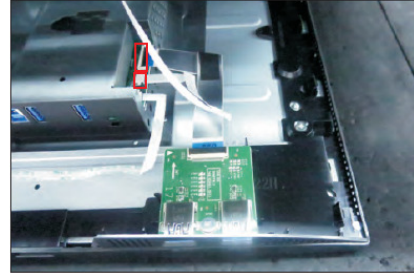

Use a Philips-head screwdriver to tighten 4pcs screws for locking rear cover with the assembled unit. Stick 2pcs labels on the specific positions as the picture below shown

(No.1~4 screw size=M4x10; Torque=12±0.5kgfcm)

S17

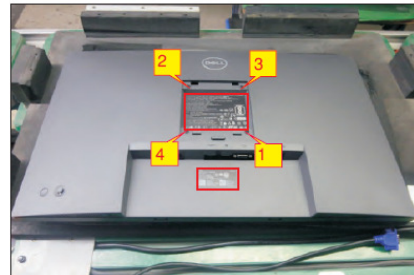

Take 1pcs assembled stand base, then fit the two tabs on the upper part of the stand into the grooves on the back of the monitor, and then press the stand so that the monitor mounting area snaps onto the stand.

S18

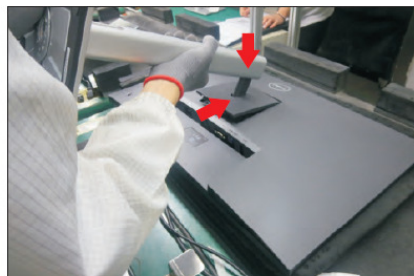

S19

Lift up the monitor, then provide power supply and a video signal to the monitor, then turn on the monitor for functionality check.





## 9. How to connect and disconnect power cable/ connectivity cable

**WARNING:** To change power cable/ connectivity cable, switch off power before unplugging the cable and replugging in required cable.

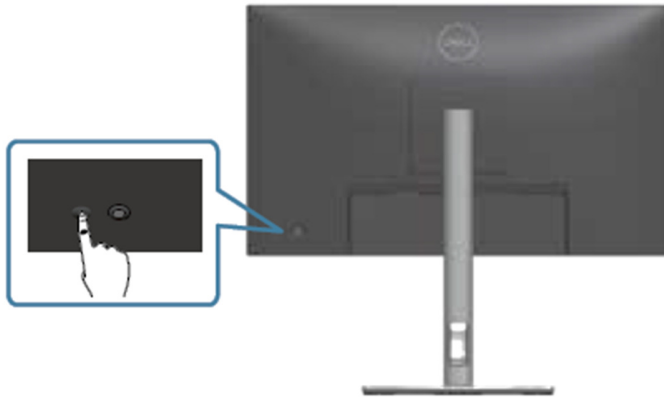

### Connecting / disconnecting Power cable

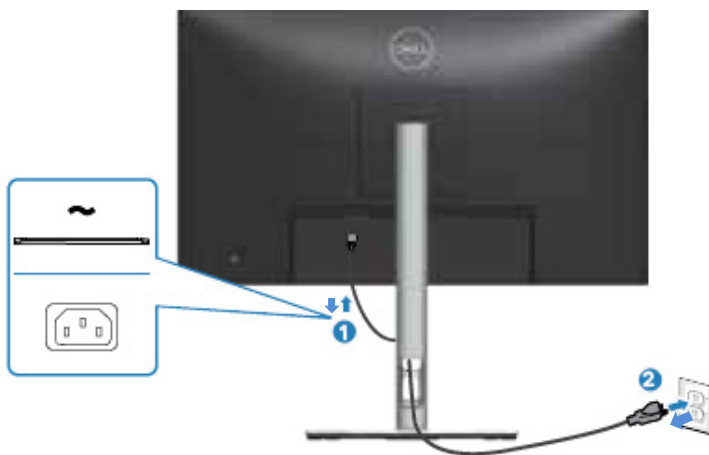

### Connect/ disconnecting the DisplayPort cable and USB cable

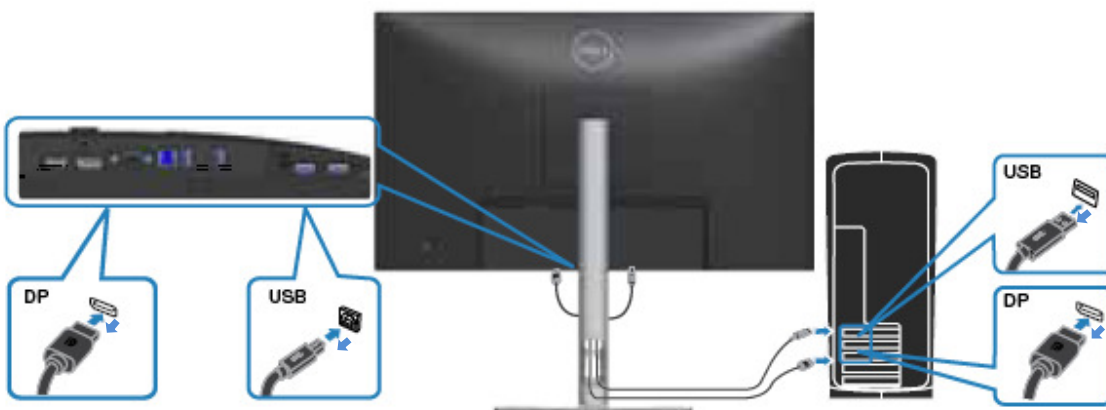

**Connecting/ disconnecting the HDMI cable (optional)**



**Connecting/ disconnecting the VGA cable (optional)**

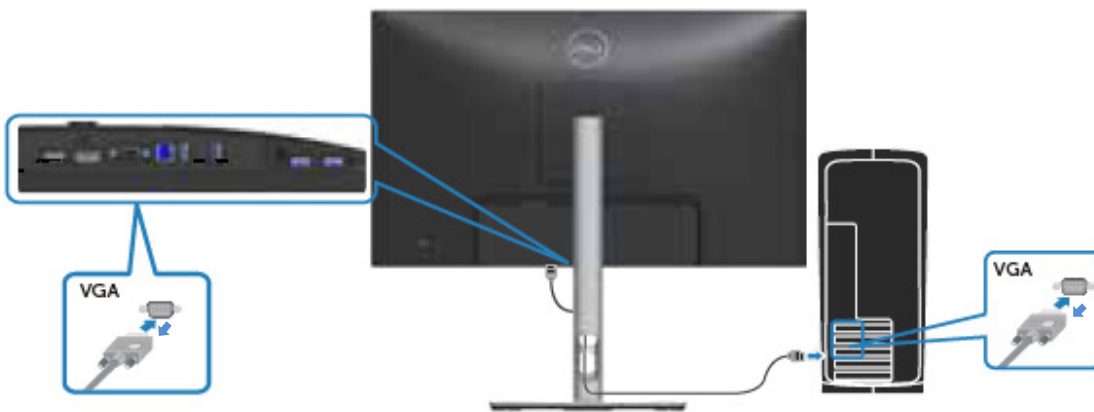

## 10. Trouble shooting instructions

# Troubleshooting

**⚠ WARNING:** Before you begin any of the procedures in this section, follow the [Safety instructions](#).

## Self-Test

Your monitor provides a self-test feature that allows you to check if your monitor is functioning properly. If your monitor and computer are properly connected but the monitor screen remains dark, run the monitor self-test by performing the following steps:

1. Turn off both your computer and the monitor.
2. Disconnect all video cables from the monitor. This way, the computer doesn't have to be involved.
3. Turn on the monitor.

The floating dialog box should appear on-screen (against a black background), if the monitor cannot sense a video signal and is working correctly. While in self-test mode, the power LED remains white. Also, depending upon the selected input, one of the dialogs shown below will continuously scroll through the screen.

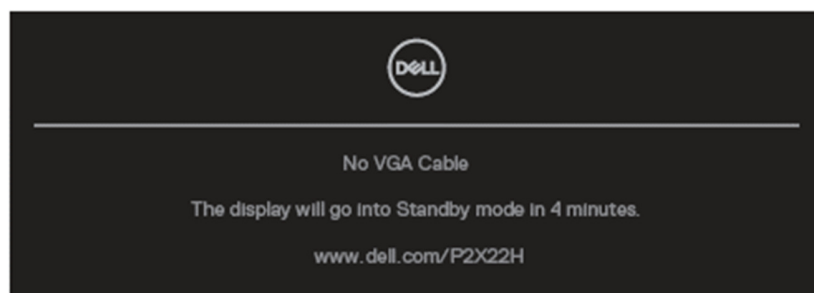

OR



OR



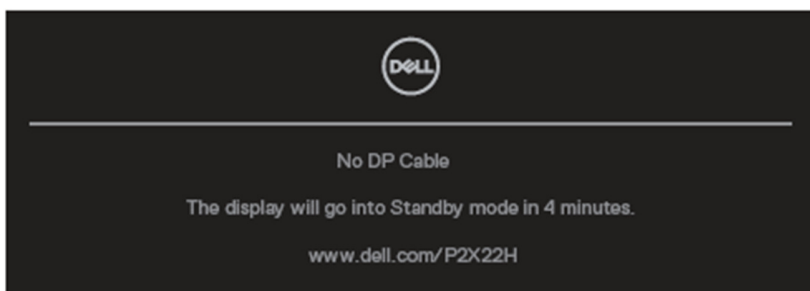

4. This box also appears during normal system operation, if the video cable becomes disconnected or damaged.
5. Turn Off your monitor and reconnect the video cable; then turn On both your computer and the monitor.

If your monitor screen remains blank after you use the previous procedure, check your video controller and computer, because your monitor is functioning properly.

## Built-in diagnostics

Your monitor has a built-in diagnostic tool that helps you determine if any screen abnormality you experience is an inherent problem with your monitor, or with your computer and video card.

To run the built-in diagnostics:

1. Ensure that the screen is clean (no dust particles on the surface of the screen).
2. Move and hold the joystick up/down/left/right about 4 seconds until a pop-up menu appears.



3. Move the joystick to highlight the Diagnostic icon  then press the joystick to confirm. A gray test pattern appears.



4. Carefully inspect the screen for abnormalities.
5. Press the joystick to change the test patterns.
6. Repeat steps 4 and 5 to inspect the display in red, green, blue, black, white, and text screens.
7. Press the joystick to end the diagnostic program.

## Common problems

The following table contains general information about common monitor problems you might encounter and the possible solutions:

Common Symptoms	Possible Solutions
No Video/Power LED off	<ul style="list-style-type: none"><li>Ensure that the video cable connecting the monitor and the computer is properly connected and secure.</li><li>Verify that the power outlet is functioning properly using any other electrical equipment.</li><li>Ensure that the power button is pressed.</li><li>Ensure that the correct input source is selected via the <a href="#">Input Source</a> menu.</li></ul>
No Video/Power LED on	<ul style="list-style-type: none"><li>Increase brightness and contrast controls using the OSD.</li><li>Perform monitor self-test feature check.</li><li>Check for bent or broken pins in the video cable connector.</li><li>Run the built-in diagnostics.</li><li>Ensure that the correct input source is selected via the <a href="#">Input Source</a> menu.</li></ul>
Poor Focus	<ul style="list-style-type: none"><li>Eliminate video extension cables.</li><li>Reset the monitor to Factory Settings (<b>Factory Reset</b>).</li><li>Change the video resolution to the correct aspect ratio.</li></ul>
Shaky/Jittery Video	<ul style="list-style-type: none"><li>Reset the monitor to Factory Settings (<b>Factory Reset</b>).</li><li>Check environmental factors.</li><li>Relocate the monitor and test in another room.</li></ul>
Missing Pixels	<ul style="list-style-type: none"><li>Cycle power On-Off.</li><li>Pixel that is permanently Off is a natural defect that can occur in LCD technology.</li><li>For more information on Dell Monitor Quality and Pixel Policy, see Dell Support site at: <a href="http://www.dell.com/pixelguidelines">www.dell.com/pixelguidelines</a>.</li></ul>
Stuck-on Pixels	<ul style="list-style-type: none"><li>Cycle power On-Off.</li><li>Pixel that is permanently off is a natural defect that can occur in LCD technology.</li><li>For more information on Dell Monitor Quality and Pixel Policy, see Dell Support site at: <a href="http://www.dell.com/pixelguidelines">www.dell.com/pixelguidelines</a>.</li></ul>



Brightness Problems	<ul style="list-style-type: none"> <li>Reset the monitor to Factory Settings (<b>Factory Reset</b>).</li> <li>Adjust brightness &amp; contrast controls via OSD.</li> </ul>
Geometric Distortion	<ul style="list-style-type: none"> <li>Reset the monitor to Factory Settings (<b>Factory Reset</b>).</li> <li>Adjust horizontal &amp; vertical controls via OSD.</li> </ul>
Horizontal/Vertical Lines	<ul style="list-style-type: none"> <li>Reset the monitor to Factory Settings (<b>Factory Reset</b>).</li> <li>Perform monitor self-test feature check and determine if these lines are also in self-test mode.</li> <li>Check for bent or broken pins in the video cable connector.</li> <li>Run the built-in diagnostics.</li> </ul>
Synchronization Problems	<ul style="list-style-type: none"> <li>Reset the monitor to Factory Settings (<b>Factory Reset</b>).</li> <li>Perform monitor self-test feature check to determine if the scrambled screen appears in self-test mode.</li> <li>Check for bent or broken pins in the video cable connector.</li> <li>Restart the computer in the safe mode.</li> </ul>
Safety Related Issues	<ul style="list-style-type: none"> <li>Do not perform any troubleshooting steps.</li> <li>Contact Dell immediately.</li> </ul>
Intermittent Problems	<ul style="list-style-type: none"> <li>Ensure that the video cable connecting the monitor to the computer is connected properly and is secure.</li> <li>Reset the monitor to Factory Settings (<b>Factory Reset</b>).</li> <li>Perform monitor self-test feature check to determine if the intermittent problem occurs in self-test mode.</li> </ul>
Missing Color	<ul style="list-style-type: none"> <li>Perform monitor self-test feature check.</li> <li>Ensure that the video cable connecting the monitor to the computer is connected properly and is secure.</li> <li>Check for bent or broken pins in the video cable connector.</li> </ul>
Wrong Color	<ul style="list-style-type: none"> <li>Change the <b>Color Setting Mode</b> in the <b>Color Settings</b> OSD to <b>Graphics</b> or <b>Video</b> depending on the application.</li> <li>Try different <b>Preset Modes</b> in <b>Color</b> settings OSD. Adjust <b>R/G/B</b> value in <b>Custom Color</b> in <b>Color</b> settings OSD.</li> <li>Change the <b>Input Color Format</b> to <b>RGB</b> or <b>YCbCr(digital)/YPbPr(analog)</b> in the <b>Color settings</b> OSD.</li> <li>Run the built-in diagnostics.</li> </ul>

---

Image retention from a static image left on the monitor for a long period of time	<ul style="list-style-type: none"><li>• Set the screen to turn off after a few minutes of screen idle time. These can be adjusted in Windows Power Options or Mac Energy Saver setting.</li><li>• Alternatively, use a dynamically changing screensaver.</li></ul>
Video Ghosting or Overshooting	<ul style="list-style-type: none"><li>• Change the <b>Response Time</b> in the <b>Display</b> OSD to <b>Normal</b>, or <b>Fast</b> depending on your application and usage.</li></ul>

---

## Product-specific problems

Specific Symptoms	Possible Solutions
Screen image is too small	<ul style="list-style-type: none"><li>• Check the <b>Aspect Ratio</b> setting in the <b>Display</b> settings OSD.</li><li>• Reset the monitor to Factory Settings (<b>Factory Reset</b>).</li></ul>
Cannot adjust the monitor with the joystick	<ul style="list-style-type: none"><li>• Turn Off the monitor, unplug the power cord, plug it back, and then turn On the monitor.</li><li>• Check whether the OSD menu is locked. If yes, move and hold the joystick up/down/left/right for 4 seconds to unlock (for more information, see <a href="#">Menu and Power button lock</a>).</li></ul>
No Input Signal when user controls are pressed	<ul style="list-style-type: none"><li>• Check the signal source. Ensure the computer is not in Standby Mode by moving the mouse or pressing any key on the keyboard.</li><li>• Check if the video cable is plugged in properly. Disconnect and reconnect the video cable if necessary.</li><li>• Reset the computer or video player.</li></ul>
The picture does not fill the entire screen	<ul style="list-style-type: none"><li>• Due to different video formats (aspect ratio) of DVDs, the monitor may display in full screen.</li><li>• Run the built-in diagnostics.</li></ul>

## Universal Serial Bus (USB) specific problems

Specific Symptoms	Possible Solutions
USB interface is not working	<ul style="list-style-type: none"><li>• Check that your monitor is turned On.</li><li>• Reconnect the upstream cable to your computer.</li><li>• Reconnect the USB peripherals (downstream connector).</li><li>• Turn off the monitor and turn it on again.</li><li>• Reboot the computer.</li><li>• Certain USB devices such as portable hard drive require higher power source; connect the drive to the computer directly.</li></ul>



---

SuperSpeed USB 5 Gbps (USB 3.2 Gen1) interface is slow

- Check that your computer is SuperSpeed USB 5 Gbps (USB 3.2 Gen1)-compatible.
- Some computers have USB 3.2, USB 2.0, and USB 1.1 ports. Ensure that the correct USB port is used.
- Reconnect the upstream cable to your computer.
- Reconnect the USB peripherals (downstream connector).
- Reboot the computer.

---

Wireless USB peripherals stop working when a USB 3.2 device is plugged in

- Increase the distance between the USB 3.2 peripherals and the wireless USB receiver.
  - Position your wireless USB receiver as close as possible to the wireless USB peripherals.
  - Use a USB-extender cable to position the wireless USB receiver as far away as possible from the USB 3.2 port.
-