



OPEN Industry Standard, Flexible Architecture

GREEN Less Heat, Less Power Consumption

STABLE Robust Design, Quality Parts

Stable and
Reliable Solution

Server/Workstation

Motherboard

B650D4U

B650D4U-2L2T

B650D4U-2L2T/BCM

User Manual

English

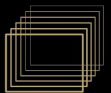

Version 1.0

Published January 2023

Copyright©2023 ASRock Rack INC. All rights reserved.

Copyright Notice:

No part of this documentation may be reproduced, transcribed, transmitted, or translated in any language, in any form or by any means, except duplication of documentation by the purchaser for backup purpose, without written consent of ASRock Rack Inc.

Products and corporate names appearing in this documentation may or may not be registered trademarks or copyrights of their respective companies, and are used only for identification or explanation and to the owners' benefit, without intent to infringe.

Disclaimer:

Specifications and information contained in this documentation are furnished for informational use only and subject to change without notice, and should not be constructed as a commitment by ASRock Rack. ASRock Rack assumes no responsibility for any errors or omissions that may appear in this documentation.

With respect to the contents of this documentation, ASRock Rack does not provide warranty of any kind, either expressed or implied, including but not limited to the implied warranties or conditions of merchantability or fitness for a particular purpose.

In no event shall ASRock Rack, its directors, officers, employees, or agents be liable for any indirect, special, incidental, or consequential damages (including damages for loss of profits, loss of business, loss of data, interruption of business and the like), even if ASRock Rack has been advised of the possibility of such damages arising from any defect or error in the documentation or product.



This device complies with Part 15 of the FCC Rules. Operation is subject to the following two conditions:

- (1) this device may not cause harmful interference, and
- (2) this device must accept any interference received, including interference that may cause undesired operation.

This equipment has been tested and found to comply with the limits for a Class B digital device, pursuant to part 15 of the FCC Rules. These limits are designed to provide reasonable protection against harmful interference in a residential installation. This equipment generates, uses and can radiate radio frequency energy and, if not installed and used in accordance with the instructions, may cause harmful interference to radio communications. However, there is no guarantee that interference will not occur in a particular installation. If this equipment does cause harmful interference to radio or television reception, which can be determined by turning the equipment off and on, the user is encouraged to try to correct the interference by one or more of the following measures:

- Reorient or relocate the receiving antenna.
- Increase the separation between the equipment and receiver.
- Connect the equipment into an outlet on a circuit different from that to which the receiver is connected.
- Consult the dealer or an experienced radio/TV technician for help.

CALIFORNIA, USA ONLY

The Lithium battery adopted on this motherboard contains Perchlorate, a toxic substance controlled in Perchlorate Best Management Practices (BMP) regulations passed by the California Legislature. When you discard the Lithium battery in California, USA, please follow the related regulations in advance.

“Perchlorate Material-special handling may apply, see www.dtsc.ca.gov/hazardouswaste/perchlorate”

AUSTRALIA ONLY

Our goods come with guarantees that cannot be excluded under the Australian Consumer Law. You are entitled to a replacement or refund for a major failure and compensation for any other reasonably foreseeable loss or damage caused by our goods. You are also entitled to have the goods repaired or replaced if the goods fail to be of acceptable quality and the failure does not amount to a major failure. If you require assistance please call ASRock Rack Tel : +886-2-55599600 ext.123 (Standard International call charges apply)



ASRock Rack INC. hereby declares that this device is in compliance with the essential requirements and other relevant provisions of related UKCA Directives. Full text of UKCA declaration of conformity is available at: <http://www.asrockrack.com>



ASRock Rack INC. hereby declares that this device is in compliance with the essential requirements and other relevant provisions of related Directives. Full text of EU declaration of conformity is available at: <http://www.asrockrack.com>

ASRock Rack follows the green design concept to design and manufacture our products, and makes sure that each stage of the product life cycle of ASRock Rack product is in line with global environmental regulations. In addition, ASRock Rack disclose the relevant information based on regulation requirements.

Please refer to <https://www.asrockrack.com/general/about.asp?cat=Responsibility> for information disclosure based on regulation requirements ASRock Rack is complied with:



DO NOT throw the motherboard in municipal waste. This product has been designed to enable proper reuse of parts and recycling. This symbol of the crossed out wheeled bin indicates that the product (electrical and electronic equipment) should not be placed in municipal waste. Check local regulations for disposal of electronic products.

Contents

Chapter 1 Introduction	1
1.1 Package Contents	1
1.2 Specifications	2
1.3 Unique Features	6
1.4 Motherboard Layout	7
1.5 Onboard LED Indicators	11
1.6 I/O Panel	13
1.7 Block Diagram	16
Chapter 2 Installation	19
2.1 Screw Holes	19
2.2 Pre-installation Precautions	19
2.3 Installing the CPU	20
2.4 Installing the CPU Fan and Heatsink	23
2.5 Installing Memory Modules (DIMM)	25
2.6 Expansion Slots (PCI Express Slots)	27
2.7 Jumper Setup	28
2.8 Onboard Headers and Connectors	29
2.9 Dr. Debug	34
2.10 Unit Identification purpose LED/Switch	40
2.11 Dual LAN and Teaming Operation Guide	41
2.12 M.2 SSD Module Installation Guide	42
Chapter 3 UEFI Setup Utility	44
3.1 Introduction	44

3.1.1	UEFI Menu Bar	44
3.1.2	Navigation Keys	45
3.2	Main Screen	46
3.3	Advanced Screen	49
3.3.1	CPU Configuration	50
3.3.2	Chipset Configuration	51
3.3.3	Storage Configuration	52
3.3.4	NVMe Configuration	53
3.3.5	ACPI Configuration	54
3.3.6	USB Configuration	55
3.3.7	Super IO Configuration	56
3.3.8	Serial Port Console Redirection	57
3.3.9	H/W Monitor	60
3.3.10	PCI Subsystem Settings	61
3.3.11	AMD CBS	62
3.3.12	Network Stack Configuration	63
3.3.13	Driver Health	64
3.3.14	Tls Auth Configuration	65
3.3.15	AMD PBS	66
3.3.16	AMD Overclocking	68
3.3.17	Inter (R) I210 Gigabit Network Connection	69
3.3.18	VLAN Configuration	70
3.3.19	IPv4 Network Configuration	71
3.3.20	IPv6 Network Configuration	72

3.3.21	Broadcom NetXtreme-E 2Px10GBASE-T OCP 3.0 Ethernet	73
3.4	Security	75
3.4.1	Install Default Secure Boot Keys	76
3.4.2	Key Management	77
3.5	Server Mgmt	81
3.5.1	BMC Network Configuration	83
3.5.2	System Event Log	85
3.5.3	BMC Tools	86
3.6	Boot Screen	87
3.7	Exit Screen	89
	Chapter 4 Software Support	90
4.1	Download and Install Operating System	90
4.2	Download and Install Software Drivers	90
4.3	Contact Information	90
	Chapter 5 Troubleshooting	91
5.1	Troubleshooting Procedures	91
5.2	Technical Support Procedures	93
5.3	Returning Merchandise for Service	93

Chapter 1 Introduction

Thank you for purchasing ASRock Rack **B650D4U-2L2T/BCM / B650D4U-2L2T / B650D4U** motherboard, a reliable motherboard produced under ASRock Rack's consistently stringent quality control. It delivers excellent performance with robust design conforming to ASRock Rack's commitment to quality and endurance.

In this manual, chapter 1 and 2 contains introduction of the motherboard and step-by-step guide to the hardware installation. Chapter 3 and 4 contains the configuration guide to BIOS setup and information of the Support Software.



Because the motherboard specifications and the BIOS software might be updated, the content of this manual will be subject to change without notice. In case any modifications of this manual occur, the updated version will be available on ASRock Rack website without further notice. You may find the latest memory and CPU support lists on ASRock Rack website as well. ASRock Rack's Website: www.ASRockRack.com

*If you require technical support related to this motherboard, please visit our website for specific information about the model you are using.
<http://www.asrockrack.com/support/>*

1.1 Package Contents

- ASRock Rack B650D4U-2L2T/BCM / B650D4U-2L2T / B650D4U Motherboard (micro ATX Form Factor: 9.6-in x 9.6-in, 24.4 cm x 24.4 cm)
- Quick Installation Guide
- 1 x I/O Shield
- 1 x SATA3 Cable (60cm)
- 1 x Screw for M.2 Socket (B650D4U-2L2T/BCM / B650D4U-2L2T only)
- 2 x Screws for M.2 Sockets (B650D4U only)



If any items are missing or appear damaged, contact your authorized dealer.

1.2 Specifications

B650D4U-2L2T/BCM / B650D4U-2L2T / B650D4U	
Physical Status	
Form Factor	Micro-ATX
Dimension	9.6" x 9.6" (244 mm x 244 mm)
Processor System	
CPU	Supports AMD Ryzen 7000 Series Processors
Socket	1 Socket AM5 (LGA 1718)
Thermal Design Power (TDP)	120W (Air) / 170W (Liquid)
Chipset	AMD B650E
System Memory	
Supported DIMM Quantity	4 DIMM slots (2DPC)
Supported Type	DDR5 288-pin ECC/non-ECC UDIMM
Max. Capacity per DIMM	32GB
Max. DIMM Frequency	5200 MHz (1DPC); 3600 MHz (2DPC)
Voltage	1.1V
Note	Memory support is to be validated.
PCIe Expansion Slots (SLOT7 close to CPU)	
SLOT7	PCIe5.0 x4 [CPU]
SLOT6	PCIe5.0 x16 [CPU]
SLOT4	PCIe4.0 x1 [FCH]
Other PCIe Expansion Connectors	
M.2 slot	B650D4U-2L2T/BCM / B650D4U-2L2T: M2_1 (PCIe5.0 x4), supports 2280/2242 form factor [CPU] B650D4U: M2_1 (PCIe5.0 x4), supports 2280/2242 form factor [CPU] M2_2 (PCIe4.0 x4), supports 2280/2242 form factor [FCH]
OCuLink	OCuLink1 (PCIe4.0 x4) [CPU] OCuLink2 (PCIe3.0 x4 or 4 SATA 6Gb/s) [FCH]"
Note	-M.2 share lanes with OcuLink1, M2_1 and OcuLink1 are BOM option -4 SATA 7-pin share lanes with OcuLink2, 4 SATA 7-pin support possible by depopulating OcuLink2 and other BOM change
SATA/SAS Storage	
FCH Built-in Storage	AMD B650 (4 SATA 6Gb/s): 1 OcuLink or 4 SATA 7-pin

Ethernet	
Additional Ethernet Controller	B650D4U-2L2T/BCM: Broadcom BCM57416: 2 RJ45 (10GbE) Intel® i210: 2 RJ45 (1GbE) B650D4U-2L2T: Intel® X710: 2 RJ45 (10GbE) Intel® i210: 2 RJ45 (1GbE) B650D4U: Intel® i210: 2 RJ45 (1GbE)
USB	
Controller/Hub	AMD B650E, CPU
Connectors/Headers	External: 4 Type-A (USB3.2 Gen1) Internal: 1 header (19-pin, 2 USB3.2 Gen1) 1 header (9-pin, 2 USB2.0)
Graphics	
Controller	ASPEED AST2600: 1 DB15 (VGA), 1 (15-pin) header AMD Processors with Graphics: 1 HDMI, 1 DisplayPort
Security	
TPM	1 (13-pin, SPI)
Rear I/O	
UID Button/LED	1 UID button w/ LED
VGA Port	1 DB15 (VGA), 1 DisplayPort, 1 HDMI
Serial Port	1 DB9 (COM)
USB	4 Type-A (USB3.2 Gen1)
RJ45	B650D4U-2L2T/BCM / B650D4U-2L2T: 2 RJ45 (10GbE), 2 RJ45 (1GbE), 1 dedicated IPMI B650D4U: 2 RJ45 (1GbE), 1 dedicated IPMI
Hardware Monitor	
Temperature	CPU, DDR, MB, Card Side, Chipset, 10G LAN, M.2 slot
Fan	Fan Tachometer, Multi-Speed Control, CPU Quiet Fan (Allow Chassis Fan Speed Auto-Adjust by CPU Temperature)
Voltage	VOLT_3VSB, VOLT_5VSB, VOLT_P0_VCORE, VOLT_P0_VSOC, VOLT_VMEM, VOLT_VMISC, VOLT_1.8V_PT21, VOLT_VSUS10, VOLT_VDD10, VOLT_V10_PHY_DIG, VOLT_VDD_1P8, VOLT_MD_VDDO, VOLT_BAT, VOLT_3V, VOLT_5V, VOLT_12V

Server Management	
BMC Controller	ASPEED AST2600: IPMI2.0 with iKVM and vMedia support
IPMI Dedicated GLAN	1 Realtek RTL8211F for dedicated management GLAN
System BIOS	
BIOS Type	AMI UEFI BIOS; 256Mb (32MB) SPI Flash ROM
Features	Plug and Play, ACPI 6.4 compliance wake up events, SMBIOS 3.5
Internal Connectors/Headers	
PSU Connector	1 (24-pin, ATX main power), 2 (8-pin, ATX 12V)
Auxiliary Panel Header	1 (18-pin): chassis intrusion, system fault LED, LAN activity LED
System Panel	1 (9-pin): power switch, reset switch, system power LED, HDD activity LED
LAN3/LAN4 LED Header	B650D4U-2L2T/BCM / B650D4U-2L2T: 1 B650D4U: N/A
VGA Header	1
Speaker Header	1
Fan Header	7 (6pin) co-lay 7 (4-pin)
Buzzer	1
TPM Header	1 (13-pin, SPI)
80 Debug Port Header	1 (3-pin)
SMBus Header	1
PMbus Header	1
IPMB Header	1
Clear CMOS	1
LED Indicators	
Standby Power LED	1 (5VSB)
80 Debug Port LED	1
Fan Fail LED	7
BMC Heartbeat LED	1
Support OS	
OS	<p>Microsoft® Windows*:</p> <ul style="list-style-type: none"> - Windows 10 (64 bit) - Windows 11 (64 bit) <p>Linux*:</p> <ul style="list-style-type: none"> - Ubuntu 22.04.1 (64 bit) <p><i>* On the Windows system, Raid mode supports UEFI Boot only.</i></p> <p><i>* The Linux system doesn't support Raid Mode.</i></p> <p><i>* Please refer to our website for the latest OS support list.</i></p>

Environment

Temperature	Operation temperature: 10°C - 35°C (50 - 95 degF) / Non operation temperature: -40°C - 70°C (-40 - 158degF)
Humidity	Non operation humidity: 20%~90% (Non condensing)

NOTE: Please refer to our website for the latest specifications.



This motherboard supports Wake from on Board LAN. To use this function, please make sure that the "Wake on Magic Packet from power off state" is enabled in Device Manager > Intel® Ethernet Connection > Power Management. And the "PCI Devices Power On" is enabled in UEFI SETUP UTILITY > Advanced > ACPI Configuration. After that, onboard LAN1&2 can wake up S5 under OS.



If you install Intel® LAN utility or Marvell SATA utility, this motherboard may fail Windows® Hardware Quality Lab (WHQL) certification tests. If you install the drivers only, it will pass the WHQL tests.

1.3 Unique Features

ASRock Rack Instant Flash is a BIOS flash utility embedded in Flash ROM. This convenient BIOS update tool allows you to update system BIOS without entering operating systems first like MS-DOS or Windows. With this utility, you can press the <F6> key during the POST or the <F2> key to enter into the BIOS setup menu to access ASRock Rack Instant Flash. Just launch this tool and save the new BIOS file to your USB flash drive, floppy disk or hard drive, then you can update your BIOS only in a few clicks without preparing an additional floppy diskette or other complicated flash utility. Please be noted that the USB flash drive or hard drive must use FAT32/16/12 file system.

No.	Description
1	2 x 288-pin DDR5 DIMM Slots (DDR5_A2, DDR5_B2)*
2	Front VGA Header (FRNT_VGA1)
3	2 x 288-pin DDR5 DIMM Slots (DDR5_A1, DDR5_B1)*
4	ATX 12V Power Connector (ATX12V1)
5	ATX 12V Power Connector (ATX12V2)
6	PSU SMBus Header (PSU_SMB1)
7	Clear CMOS Pad (CLRCMOS1)
8	ATX Power Connector (ATXPWR1)
9	System Fan Connector (FAN1)
10	System Fan Connector (FAN7)
11	System Fan Connector (FAN6)
12	AMD Socket AM5 (LGA 1718)
13	PWM Configuration Header (PWM_CFG1)
14	SPI TPM Header (TPM_BIOS_PH1)
15	SATA3 Connectors (SATA_1)(Upper), (SATA_0)(Lower)
16	SATA3 Connectors (SATA_3)(Upper), (SATA_2)(Lower)
17	System Fan Connector (FAN4)
18	System Fan Connector (FAN3)
19	Auxiliary Panel Header (AUX_PANEL1)
20	System Panel Header (PANEL1)
21	System Fan Connector (FAN5)
22	USB 3.2 Gen1 Header (USB3_7_8)
23	USB 2.0 Header (USB_1_2)
24	System Fan Connector (FAN2)
25	Speaker Header (SPEAKER1)
26	Front LAN LED Connector (LED_LAN3_4)
27	Chassis ID Jumper (CHASSIS_ID0)
28	Intelligent Platform Management Bus Header (IPMB_1)
29	BMC SMBus Header (BMC_SMB_1)
30	PCI Express 4.0 x1 Card Slot (PCIE4)
31	M.2 Socket (M2_1) (Type 2242/2280)
32	PCI Express 5.0 x16 Card Slot (PCIE6)
33	PCI Express 5.0 x4 Card Slot (PCIE7)

*For DIMM installation and configuration instructions, please see p.24 (Installation of Memory Modules (DIMM)) for more details.

B650D4U

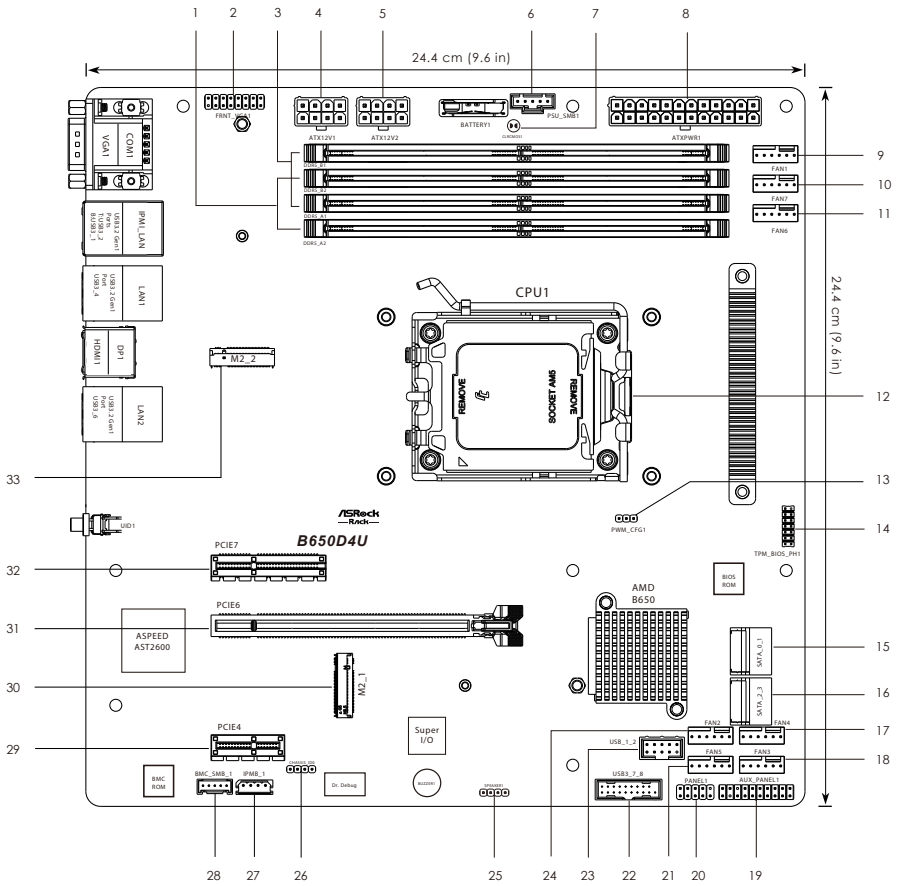

No.	Description
1	2 x 288-pin DDR5 DIMM Slots (DDR5_A2, DDR5_B2)*
2	Front VGA Header (FRNT_VGA1)
3	2 x 288-pin DDR5 DIMM Slots (DDR5_A1, DDR5_B1)*
4	ATX 12V Power Connector (ATX12V1)
5	ATX 12V Power Connector (ATX12V2)
6	PSU SMBus Header (PSU_SMB1)
7	Clear CMOS Pad (CLRCMOS1)
8	ATX Power Connector (ATXPWR1)
9	System Fan Connector (FAN1)
10	System Fan Connector (FAN7)
11	System Fan Connector (FAN6)
12	AMD Socket AM5 (LGA 1718)
13	PWM Configuration Header (PWM_CFG1)
14	TPM-SPI Header (TPM_BIOS_PH1)
15	SATA3 Connectors (SATA_1)(Upper), (SATA_0)(Lower)
16	SATA3 Connectors (SATA_3)(Upper), (SATA_2)(Lower)
17	System Fan Connector (FAN4)
18	System Fan Connector (FAN3)
19	Auxiliary Panel Header (AUX_PANEL1)
20	System Panel Header (PANEL1)
21	System Fan Connector (FAN5)
22	USB 3.2 Gen1 Header (USB3_7_8)
23	USB 2.0 Header (USB_1_2)
24	System Fan Connector (FAN2)
25	Speaker Header (SPEAKER1)
26	Chassis ID Jumper (CHASSIS_ID0)
27	Intelligent Platform Management Bus Header (IPMB_1)
28	BMC SMBus Header (BMC_SMB_1)
29	PCI Express 4.0 x1 Card Slot (PCIE4)
30	M.2 Socket (M2_1) (Type 2242/2280)
31	PCI Express 5.0 x16 Card Slot (PCIE6)
32	PCI Express 5.0 x4 Card Slot (PCIE7)
33	M.2 Socket (M2_2) (Type 2242/2280)

*For DIMM installation and configuration instructions, please see p.24 (Installation of Memory Modules (DIMM)) for more details.

1.5 Onboard LED Indicators

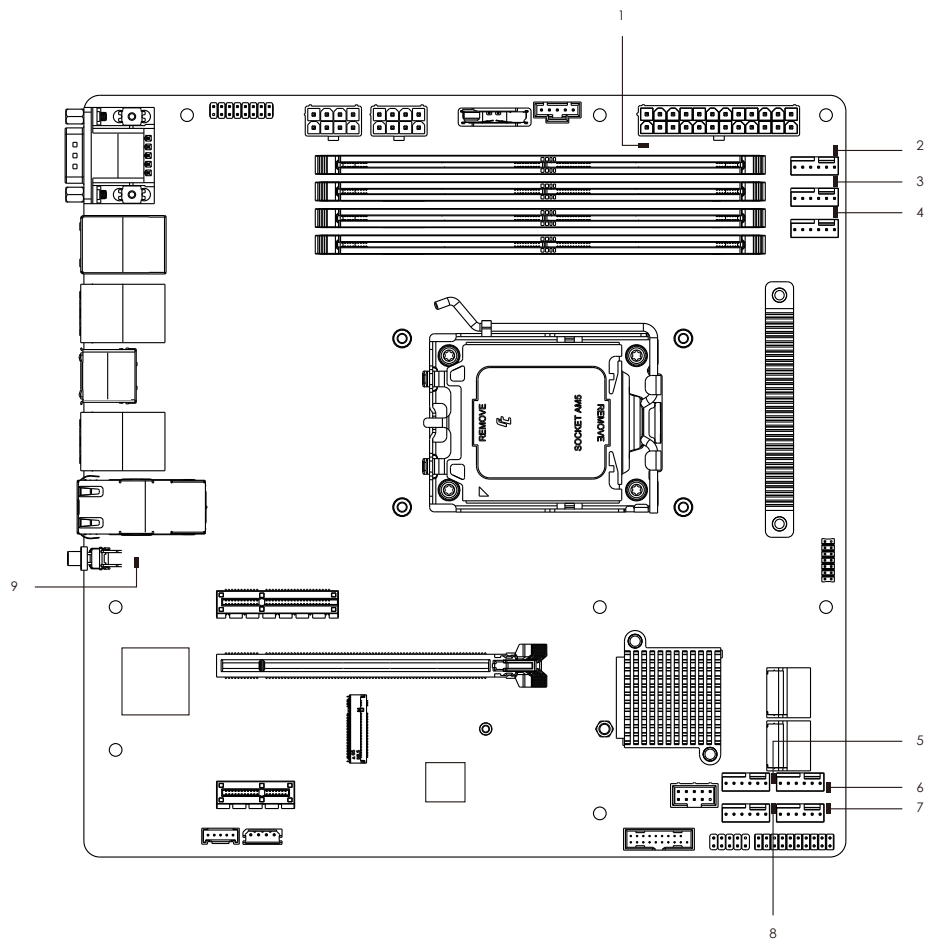

No.	Item	Status	Description
1	SB_PWR1	Green	STB PWR ready
2	FAN_LED1	Amber	FAN1 failed
3	FAN_LED7	Amber	FAN7 failed
4	FAN_LED6	Amber	FAN6 failed
5	FAN_LED2	Amber	FAN2 failed
6	FAN_LED4	Amber	FAN4 failed
7	FAN_LED3	Amber	FAN3 failed
8	FAN_LED5	Amber	FAN5 failed
9	BMC_LED1	Green	BMC heartbeat LED

1.6 I/O Panel

B650D4U-2L2T / B650D4U-2L2T/BCM

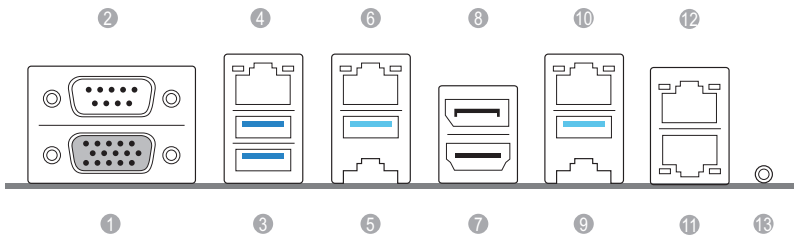

No.	Description	No.	Description
1	VGA Port (VGA1)	8	DisplayPort (DP1)
2	Serial Port (COM1)	9	USB 3.2 Gen1 Port (USB3_6)
3	USB 3.2 Gen1 Ports (USB3_1_2)	10	1G LAN RJ-45 Port (LAN2)**
4	LAN RJ-45 Port (IPMI_LAN1)*	11	10G LAN RJ-45 Port (LAN3)***
5	USB 3.2 Gen1 Port (USB3_4)	12	10G LAN RJ-45 Port (LAN4)***
6	1G LAN RJ-45 Port (LAN1)**	13	UID Switch (UID1)
7	HDMI Port (HDMI1)		

B650D4U

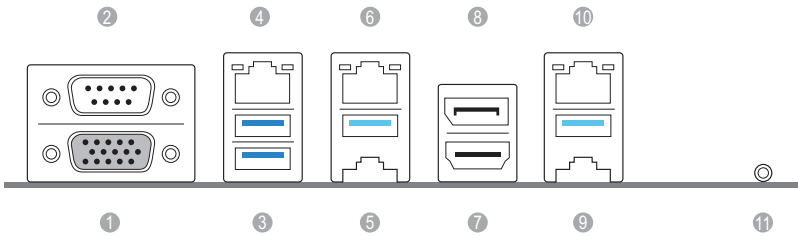

No.	Description	No.	Description
1	VGA Port (VGA1)	7	HDMI Port (HDMI1)
2	Serial Port (COM1)	8	DisplayPort (DP1)
3	USB 3.2 Gen1 Ports (USB3_1_2)	9	USB 3.2 Gen1 Port (USB3_6)
4	LAN RJ-45 Port (IPMI_LAN1)*	10	1G LAN RJ-45 Port (LAN2)**
5	USB 3.2 Gen1 Port (USB3_4)	11	UID Switch (UID1)
6	1G LAN RJ-45 Port (LAN1)**		

*There are two LED next to the LAN port. Please refer to the table below for the LAN port LED indications.

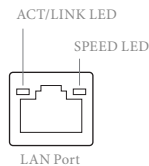

Dedicated IPMI LAN Port LED Indications

Activity / Link LED		Speed LED	
Status	Description	Status	Description
Off	No Link	Off	10M bps connection or no link
Blinking Yellow	Data Activity	Yellow	100M bps connection
On	Link	Green	1G bps connection

**There are two LEDs on each LAN port. Please refer to the table below for the LAN port LED indications.

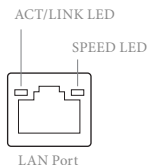

1G LAN Port (LAN1, LAN2) LED Indications

Activity / Link LED		Speed LED	
Status	Description	Status	Description
Off	No Link	Off	10Mbps connection or no link
Blinking Orange	Data Activity	Yellow	100Mbps connection
On	Link	Green	1Gbps connection

***There are two LEDs on each LAN port. Please refer to the table below for the LAN port LED indications.

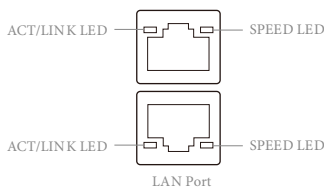

10G LAN Port (LAN3, LAN4) LED Indications (B650D4U-2L2T / B650D4U-2L2T/BCM only)

Activity / Link LED		Speed LED	
Status	Description	Status	Description
Off	No Link	Off	10M/100Mbps connection or no link
Blinking Yellow	Data Activity	Orange	1Gbps connection
On	Link	Green	10Gbps connection

1.7 Block Diagram

B650D4U-2L2T/BCM

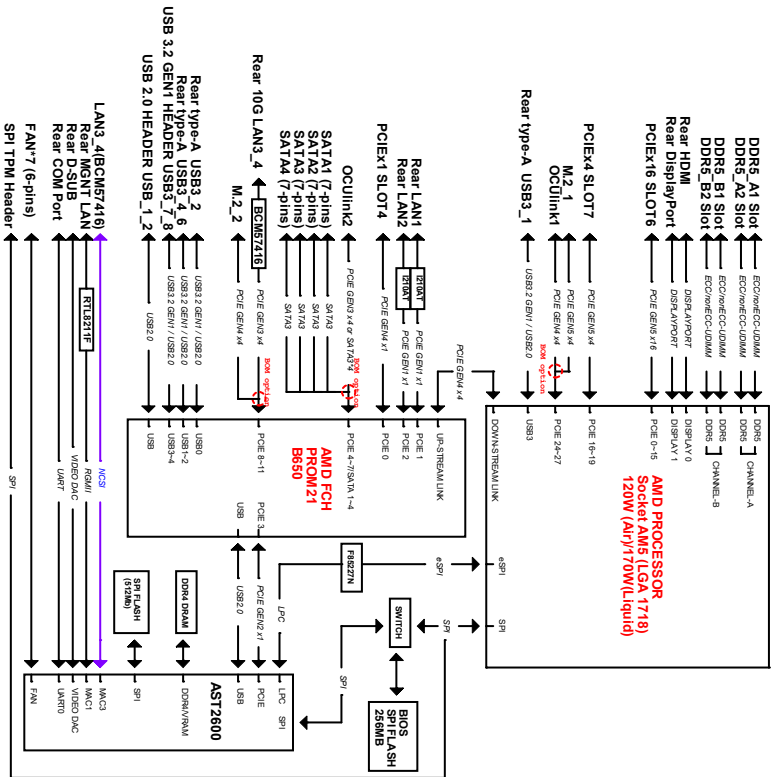

B650D4U-2L2T

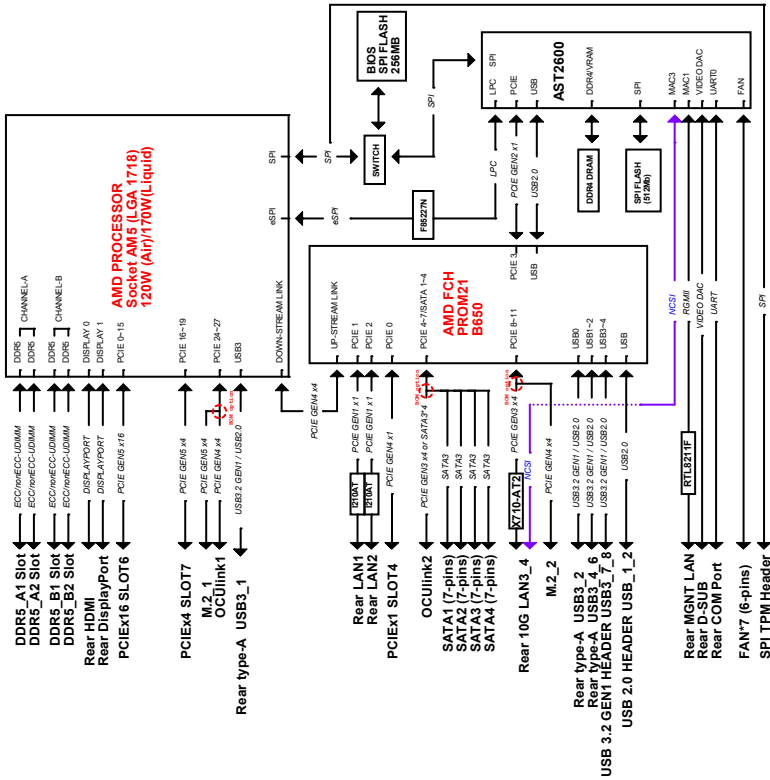

Chapter 2 Installation

This is a micro-ATX form factor (9.6" x 9.6", 24.4 cm x 24.4 cm) motherboard. Before you install the motherboard, study the configuration of your chassis to ensure that the motherboard fits into it.



Make sure to unplug the power cord before installing or removing the motherboard. Failure to do so may cause physical injuries to you and damages to motherboard components.

2.1 Screw Holes

Place screws into the holes indicated by circles to secure the motherboard to the chassis.



Do not over-tighten the screws! Doing so may damage the motherboard.

2.2 Pre-installation Precautions

Take note of the following precautions before you install motherboard components or change any motherboard settings.

1. Unplug the power cord from the wall socket before touching any components.
2. To avoid damaging the motherboard's components due to static electricity, NEVER place your motherboard directly on the carpet or the like. Also remember to use a grounded wrist strap or touch a safety grounded object before you handle the components.
3. Hold components by the edges and do not touch the ICs.
4. Whenever you uninstall any component, place it on a grounded anti-static pad or in the bag that comes with the component.
5. When placing screws into the screw holes to secure the motherboard to the chassis, please do not over-tighten the screws! Doing so may damage the motherboard.



Before you install or remove any component, ensure that the power is switched off or the power cord is detached from the power supply. Failure to do so may cause severe damage to the motherboard, peripherals, and/or components.

2.3 Installing the CPU



1. Before you insert the 1718-Pin CPU into the socket, please check if the **PnP cap** is on the socket, if the CPU surface is unclean, or if there are any **bent pins** in the socket. Do not force to insert the CPU into the socket if above situation is found. Otherwise, the CPU will be seriously damaged.
2. Unplug all power cables before installing the CPU.

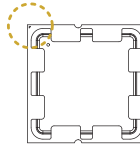
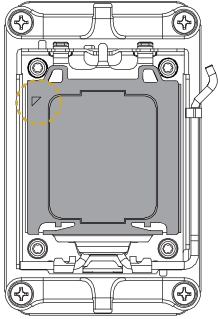

Turn your CPU to the correct orientation before opening the CPU socket cover.

1

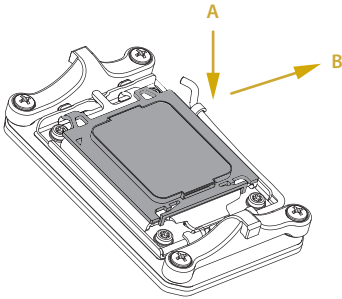

2

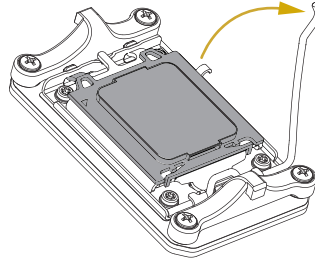

3

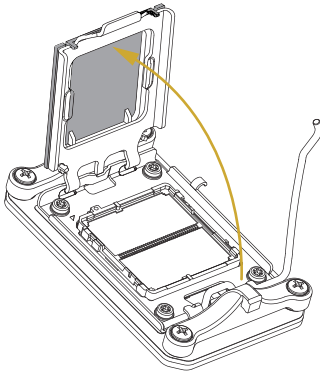

4

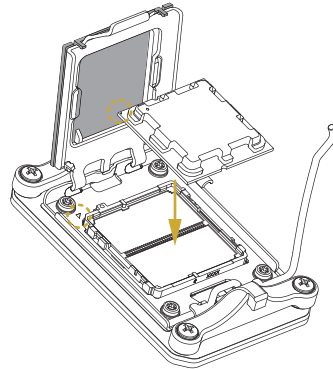

Carefully place the CPU in as flat as possible. Do not drop it.

5

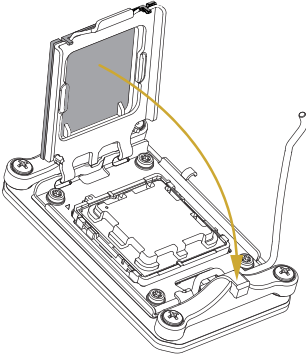

6

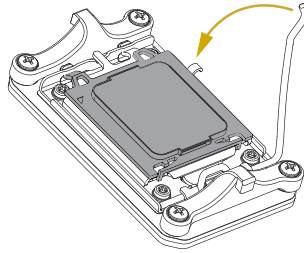

Make sure the CPU is aligned with the socket before locking it into place.

7

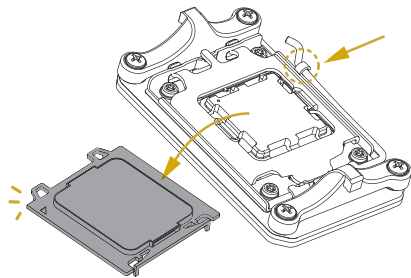

Make sure the black cover plate is always in place until it pops off when closing the socket lever.



Please save the cover if the processor is removed. The cover must be placed if you wish to return the motherboard for after service.

2.4 Installing the CPU Fan and Heatsink

After you install the CPU into this motherboard, it is necessary to install a larger heatsink and cooling fan to dissipate heat. You also need to spray thermal grease between the CPU and the heatsink to improve heat dissipation. Make sure that the CPU and the heatsink are securely fastened and in good contact with each other.



Please turn off the power or remove the power cord before changing a CPU or heatsink.

Installing the CPU Cooler

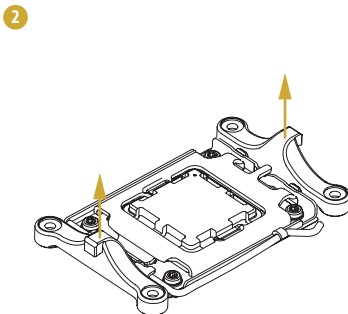
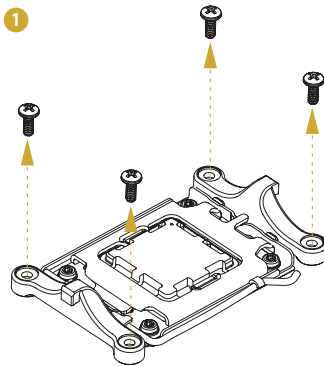

3

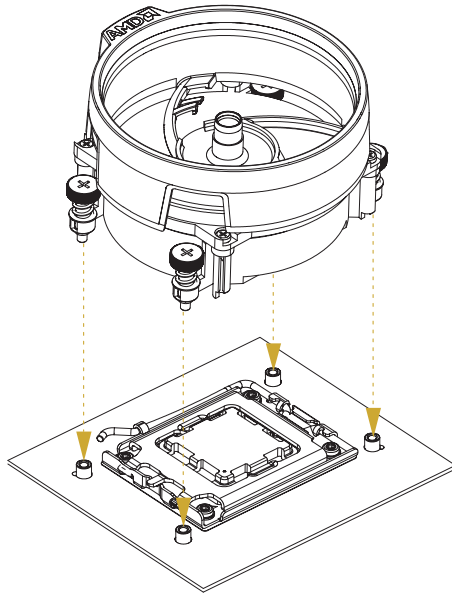

4

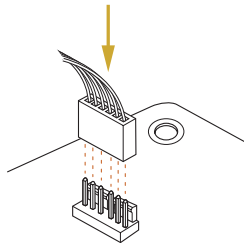

2.5 Installing Memory Modules (DIMM)

This motherboard provides four 288-pin DDR5 (Double Data Rate 5) DIMM slots, and supports Dual Channel Memory Technology.



1. For dual channel configuration, you always need to install identical (the same brand, speed, size and chip-type) DDR5 DIMM pairs.
2. It is unable to activate Dual Channel Memory Technology with only one or three memory module installed.
3. It is not allowed to install a DDR, DDR2, DDR3 or DDR4 memory module into a DDR5 slot; otherwise, this motherboard and DIMM may be damaged.
4. The DIMM only fits in one correct orientation. It will cause permanent damage to the motherboard and the DIMM if you force the DIMM into the slot at incorrect orientation.

Recommended Memory Configuration

	Priority	A1	A2	B1	B2
1 DIMM	1	Populated			
	2			Populated	
2 DIMMS	1	Populated		Populated	
	2	Populated	Populated		
	3			Populated	Populated
4 DIMMS	1	Populated	Populated	Populated	Populated

1

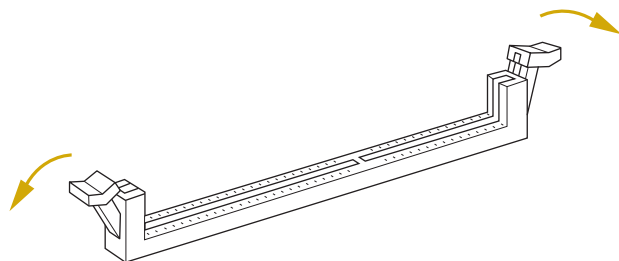

2

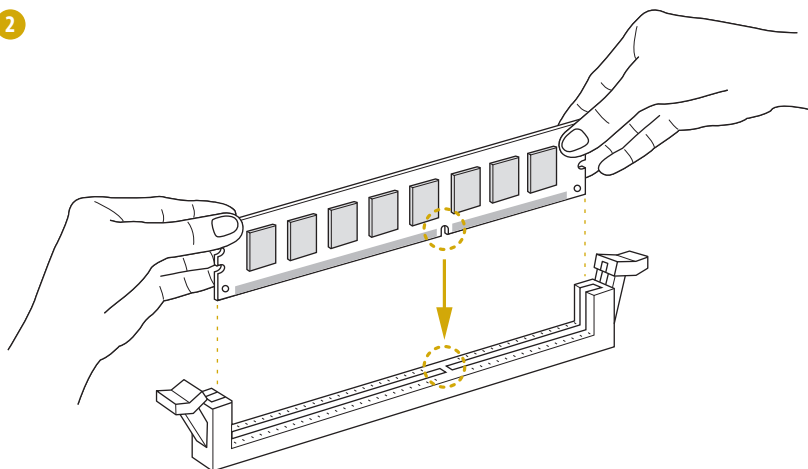

3

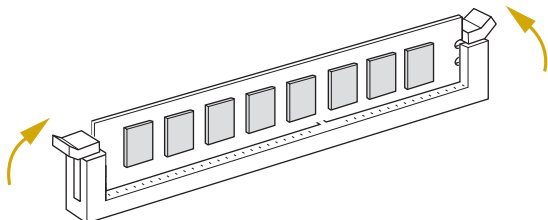

The DIMM only fits in one correct orientation. It will cause permanent damage to the motherboard and the DIMM if you force the DIMM into the slot at incorrect orientation.

2.6 Expansion Slots (PCI Express Slots)

There are 3 PCI Express slots on this motherboard.

PCIe slot:

PCIe4 (PCIe 4.0 x1 slot, from FCH) is used for PCI Express x1 lane width cards.

PCIe6 (PCIe 5.0 x16 slot, from CPU) is used for PCI Express x16 lane width cards.

PCIe7 (PCIe 5.0 x4 slot, from CPU) is used for PCI Express x4 lane width cards.

Slot	Generation	Mechanical	Electrical	Source
PCIe7	5.0	x4	x4	CPU
PCIe6	5.0	x16	x16	CPU
PCIe4	4.0	x1	x1	FCH

Installing an expansion card

- Step 1. Before installing an expansion card, please make sure that the power supply is switched off or the power cord is unplugged. Please read the documentation of the expansion card and make necessary hardware settings for the card before you start the installation.
- Step 2. Remove the system unit cover (if your motherboard is already installed in a chassis).
- Step 3. Remove the bracket facing the slot that you intend to use. Keep the screws for later use.
- Step 4. Align the card connector with the slot and press firmly until the card is completely seated on the slot.
- Step 5. Fasten the card to the chassis with screws.
- Step 6. Replace the system cover.

2.7 Jumper Setup

The illustration shows how jumpers are setup. When the jumper cap is placed on the pins, the jumper is “Short”. If no jumper cap is placed on the pins, the jumper is “Open”. The illustration shows a 3-pin jumper whose pin1 and pin2 are “Short” when a jumper cap is placed on these 2 pins.

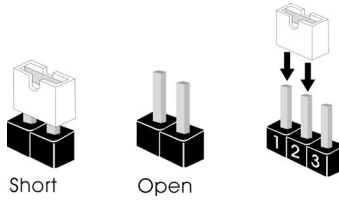

Chassis ID Jumper
(3-pin CHASSIS_ID0)



Pull-up, for BMC further
use (Default)



Pull-down, for BMC further
use

2.8 Onboard Headers and Connectors



Onboard headers and connectors are NOT jumpers. Do NOT place jumper caps over these headers and connectors. Placing jumper caps over the headers and connectors will cause permanent damage to the motherboard.

System Panel Header (9-pin PANEL1)

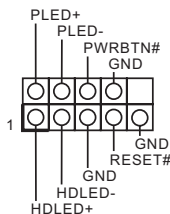

Connect the power switch, reset switch and system status indicator on the chassis to this header according to the pin assignments. Particularly note the positive and negative pins before connecting the cables.



PWRBTN (Power Switch):

Connect to the power switch on the chassis front panel. You may configure the way to turn off your system using the power switch.

RESET (Reset Switch):

Connect to the reset switch on the chassis front panel. Press the reset switch to restart the computer if the computer freezes and fails to perform a normal restart.

PLED (System Power LED):

Connect to the power status indicator on the chassis front panel. The LED is on when the system is operating. The LED is off when the system is in S4 sleep state or powered off (S5).

HDLED (Hard Drive Activity LED):

Connect to the hard drive activity LED on the chassis front panel. The LED is on when the hard drive is reading or writing data.

The front panel design may differ by chassis. A front panel module mainly consists of power switch, reset switch, power LED, hard drive activity LED, speaker and etc. When connecting your chassis front panel module to this header, make sure the wire assignments and the pin assignments are matched correctly.

Auxiliary Panel Header (18-pin AUX PANEL1)

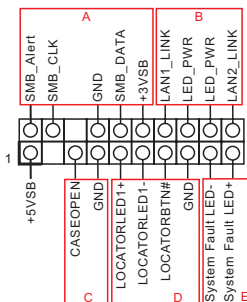

This header supports multiple functions on the front panel, including the front panel SMB, internet status indicator and chassis intrusion pin.



A. Front panel SMBus connecting pin (6-1 pin FPSMB)

This header allows you to connect SMBus (System Management Bus) equipment. It can be used for communication between peripheral equipment in the system, which has slower transmission rates, and power management equipment.

B. Internet status indicator (2-pin LAN1_LED, LAN2_LED)

These two 2-pin headers allow you to use the Gigabit internet indicator cable to connect to the LAN status indicator. When this indicator flickers, it means that the internet is properly connected.

C. Chassis intrusion pin (2-pin CHASSIS)

This header is provided for host computer chassis with chassis intrusion detection designs. In addition, it must also work with external detection equipment, such as a chassis intrusion detection sensor or a microswitch. When this function is activated, if any chassis component movement occurs, the sensor will immediately detect it and send a signal to this header, and the system will then record this chassis intrusion event. The default setting is set to the CASEOPEN and GND pin; this function is off.

D. Locator LED (4-pin LOCATOR)

This header is for the locator switch and LED on the front panel.

E. System Fault LED (2-pin LOCATOR)

This header is for the Fault LED on the system.

USB 3.2 Gen1 Header
 (19-pin USB3_7_8)

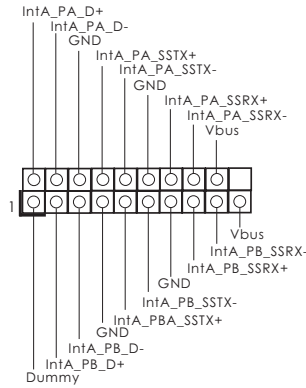

Besides two default USB 3.2 Gen1 ports on the I/O panel, there is one USB 3.2 Gen1 header on this motherboard. This USB 3.2 Gen1 header can support two USB 3.2 Gen1 ports.

USB 2.0 Header
 (9-pin USB_1_2)

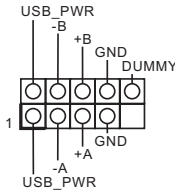

There is one USB 2.0 header on this motherboard. Each USB 2.0 header can support two ports.

Chassis Speaker Header
 (4-pin SPEAKER1)

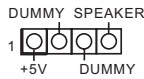

Please connect the chassis speaker to this header.

- System Fan Connectors**
- (6-pin FAN1)
 - (6-pin FAN2)
 - (6-pin FAN3)
 - (6-pin FAN4)
 - (6-pin FAN5)
 - (6-pin FAN6)
 - (6-pin FAN7)

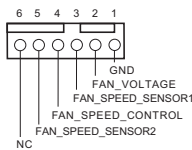

Please connect fan cables to the fan connectors and match the black wire to the ground pin. All fans support Fan Control.

ATX Power Connector
 (24-pin ATXPWR1)

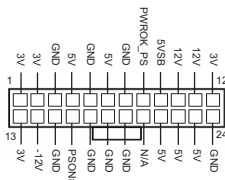

This motherboard provides a 24-pin ATX power connector. To use a 20-pin ATX power supply, please plug it along Pin 1 and Pin 13.

ATX 12V Power
Connectors
(8-pin ATX12V1)
(8-pin ATX12V2)

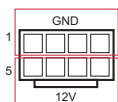

This motherboard provides one 8-pin and one 4-pin ATX 12V power connectors.

SPI TPM Header
(13-pin TPM_BIOS_PH1)

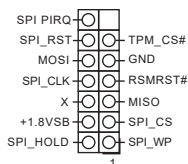

This connector supports Trusted Platform Module (TPM) system for SPI interface, which can securely store keys, digital certificates, passwords, and data. A TPM system also helps enhance network security, protects digital identities, and ensures platform integrity.

PSU SMBus Header
(5-pin PSU_SMB1)

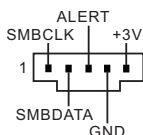

PSU SMBus monitors the status of the power supply, fan and system temperature.

Intelligent Platform
Management Bus Header
(4-pin IPMB_1)

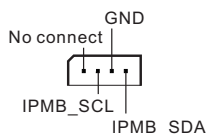

This 4-pin connector is used to provide a cabled base-board or front panel connection for value added features and 3rd-party add-in cards, such as Emergency Management cards, that provide management features using the IPMB.

Baseboard Management
Controller SMBus Header
(5-pin BMC_SMB_1)

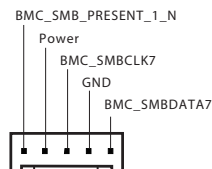

The header is used for the SM BUS devices.

PWM Configuration
Header
(3-pin PWM_CFG1)

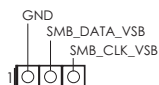

This header is used for PWM configurations.

Clear CMOS Pad
 (CLR_MOS1)



This allows you to clear the data in CMOS. To clear CMOS, take out the CMOS battery and short the Clear CMOS Pad.

Serial ATA3 Connectors
 (SATA_0)
 (SATA_1)
 (SATA_2)
 (SATA_3)

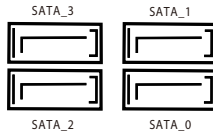

These four SATA3 connectors support SATA data cables for internal storage devices with up to 6.0 Gb/s data transfer rate.

Front VGA Header
 (15-pin FRNT_VGA1)

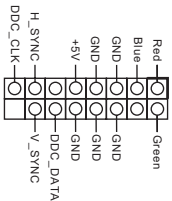

Please connect either end of VGA_2X8 cable to VGA header.

Front LAN LED
 Connector
 (LED_LAN3_4)
 (B650D4U-2L2T only)

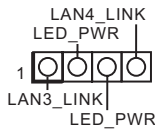

This 4-pin connector is used for the front LAN status indicator.

2.9 Dr. Debug

Dr. Debug is used to provide code information, which makes troubleshooting even easier. Please see the diagrams below for reading the Dr. Debug codes.

Code	Description
0x10	PEI_CORE_STARTED
0x11	PEI_CAR_CPU_INIT
0x15	PEI_CAR_NB_INIT
0x19	PEI_CAR_SB_INIT
0x31	PEI_MEMORY_INSTALLED
0x32	PEI_CPU_INIT
0x33	PEI_CPU_CACHE_INIT
0x34	PEI_CPU_AP_INIT
0x35	PEI_CPU_BSP_SELECT
0x36	PEI_CPU_SMM_INIT
0x37	PEI_MEM_NB_INIT
0x3B	PEI_MEM_SB_INIT
0x4F	PEI_DXE_IPL_STARTED
0x60	DXE_CORE_STARTED
0x61	DXE_NVRAM_INIT
0x62	DXE_SBRUN_INIT

0x63	DXE_CPU_INIT
0x68	DXE_NB_HB_INIT
0x69	DXE_NB_INIT
0x6A	DXE_NB_SMM_INIT
0x70	DXE_SB_INIT
0x71	DXE_SB_SMM_INIT
0x72	DXE_SB_DEVICES_INIT
0x78	DXE_ACPI_INIT
0x79	DXE_CSM_INIT
0x90	DXE_BDS_STARTED
0x91	DXE_BDS_CONNECT_DRIVERS
0x92	DXE_PCI_BUS_BEGIN
0x93	DXE_PCI_BUS_HPC_INIT
0x94	DXE_PCI_BUS_ENUM
0x95	DXE_PCI_BUS_REQUEST_RESOURCES
0x96	DXE_PCI_BUS_ASSIGN_RESOURCES
0x97	DXE_CON_OUT_CONNECT
0x98	DXE_CON_IN_CONNECT

0x99	DXE_SIO_INIT
0x9A	DXE_USB_BEGIN
0x9B	DXE_USB_RESET
0x9C	DXE_USB_DETECT
0x9D	DXE_USB_ENABLE
0xA0	DXE_IDE_BEGIN
0xA1	DXE_IDE_RESET
0xA2	DXE_IDE_DETECT
0xA3	DXE_IDE_ENABLE
0xA4	DXE_SCSI_BEGIN
0xA5	DXE_SCSI_RESET
0xA6	DXE_SCSI_DETECT
0xA7	DXE_SCSI_ENABLE
0xA8	DXE_SETUP_VERIFYING_PASSWORD
0xA9	DXE_SETUP_START
0xAB	DXE_SETUP_INPUT_WAIT
0xAD	DXE_READY_TO_BOOT
0xAE	DXE_LEGACY_BOOT

0xAF	DXE_EXIT_BOOT_SERVICES
0xB0	RT_SET_VIRTUAL_ADDRESS_MAP_BEGIN
0xB1	RT_SET_VIRTUAL_ADDRESS_MAP_END
0xB2	DXE_LEGACY_OPROM_INIT
0xB3	DXE_RESET_SYSTEM
0xB4	DXE_USB_HOTPLUG
0xB5	DXE_PCI_BUS_HOTPLUG
0xB6	DXE_NVRAM_CLEANUP
0xB7	DXE_CONFIGURATION_RESET
0xF0	PEI_RECOVERY_AUTO
0xF1	PEI_RECOVERY_USER
0xF2	PEI_RECOVERY_STARTED
0xF3	PEI_RECOVERY_CAPSULE_FOUND
0xF4	PEI_RECOVERY_CAPSULE_LOADED
0xE0	PEI_S3_STARTED
0xE1	PEI_S3_BOOT_SCRIPT
0xE2	PEI_S3_VIDEO_REPOST

0xE3	PEI_S3_OS_WAKE
0x50	PEI_MEMORY_INVALID_TYPE
0x53	PEI_MEMORY_NOT_DETECTED
0x55	PEI_MEMORY_NOT_INSTALLED
0x57	PEI_CPU_MISMATCH
0x58	PEI_CPU_SELF_TEST_FAILED
0x59	PEI_CPU_NO_MICROCODE
0x5A	PEI_CPU_ERROR
0x5B	PEI_RESET_NOT_AVAILABLE
0xD0	DXE_CPU_ERROR
0xD1	DXE_NB_ERROR
0xD2	DXE_SB_ERROR
0xD3	DXE_ARCH_PROTOCOL_NOT_AVAILABLE
0xD4	DXE_PCI_BUS_OUT_OF_RESOURCES
0xD5	DXE_LEGACY_OPROM_NO_SPACE
0xD6	DXE_NO_CON_OUT
0xD7	DXE_NO_CON_IN

0xD8 DXE_INVALID_PASSWORD

0xD9 DXE_BOOT_OPTION_LOAD_ERROR

0xDA DXE_BOOT_OPTION_FAILED

0xDB DXE_FLASH_UPDATE_FAILED

0xDC DXE_RESET_NOT_AVAILABLE

0xE8 PEI_MEMORY_S3_RESUME_FAILED

0xE9 PEI_S3_RESUME_PPI_NOT_FOUND

0xEA PEI_S3_BOOT_SCRIPT_ERROR

0xEB PEI_S3_OS_WAKE_ERROR

2.10 Unit Identification purpose LED/Switch

With the UID button, You are able to locate the server you're working on from behind a rack of servers.

Unit Identification
purpose LED/Switch
(UID1)



When the UID button on the front or rear panel is pressed, the front/rear UID blue LED indicator will be turned on. Press the UID button again to turn off the indicator.

2.11 Dual LAN and Teaming Operation Guide

Dual LAN with Teaming enabled on this motherboard allows two single connections to act as one single connection for twice the transmission bandwidth, making data transmission more effective and improving the quality of transmission of distant images. Fault tolerance on the dual LAN network prevents network downtime by transferring the workload from a failed port to a working port.



The speed of transmission is subject to the actual network environment or status even with Teaming enabled.

Before setting up Teaming, please make sure whether your Switch (or Router) supports Teaming (IEEE 802.3ad Link Aggregation). You can specify a preferred adapter in Intel PROSet. Under normal conditions, the Primary adapter handles all non-TCP/IP traffic. The Secondary adapter will receive fallback traffic if the primary fails. If the Preferred Primary adapter fails, but is later restored to an active status, control is automatically switched back to the Preferred Primary adapter.

Step 1

From **Device Manager**, open the properties of a team.

Step 2

Click the **Settings** tab.

Step 3

Click the **Modify Team** button.

Step 4

Select the adapter you want to be the primary adapter and click the **Set Primary** button.

If you do not specify a preferred primary adapter, the software will choose an adapter of the highest capability (model and speed) to act as the default primary. If a failover occurs, another adapter becomes the primary. The adapter will, however, rejoin the team as a non-primary.

2.12 M.2 SSD Module Installation Guide

The Hyper M.2 Socket (M2_1, Key M) supports type 2242/2280 M.2 PCI Express module up to Gen5 x4 (32GT/s x4). The M.2 Socket (M2_2, Key M) supports type 2242/2280 M.2 PCI Express module up to Gen4 x4 (16GT/s x4) (for B650D4U only).

Installing the M.2 SSD Module

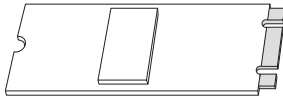

Step 1

Prepare a M.2 SSD module and the screw.

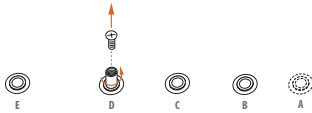

Step 2

Depending on the PCB type and length of your M.2 SSD module, find the corresponding nut location to be used.

No.	1	2
Nut Location	A	B
PCB Length	4.2cm	8cm
Module Type	Type 2242	Type 2280

Step 3

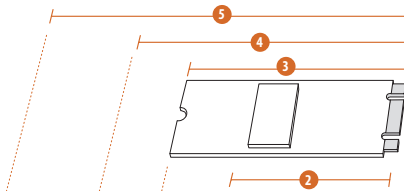

Move the standoff based on the module type and length. Skip Step 3 and 4 and go straight to Step 5 if you are going to use the default nut. Otherwise, release the standoff by hand.

Step 4



Peel off the yellow protective film on the nut to be used. Hand tighten the standoff into the desired nut location on the motherboard.

Step 5

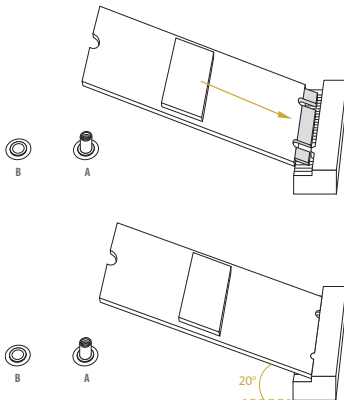

Align and gently insert the M.2 SSD module into the M.2 slot. Please be aware that the M.2 SSD module only fits in one orientation.

Step 6

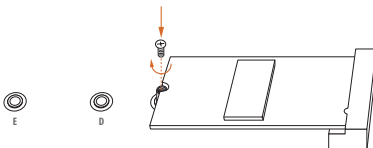

Tighten the screw with a screwdriver to secure the module into place. Please do not overtighten the screw as this might damage the module.

Chapter 3 UEFI Setup Utility

3.1 Introduction

This section explains how to use the UEFI SETUP UTILITY to configure your system. The UEFI chip on the motherboard stores the UEFI SETUP UTILITY. You may run the UEFI SETUP UTILITY when you start up the computer. Please press <F2> or during the Power-On-Self-Test (POST) to enter the UEFI SETUP UTILITY; otherwise, POST will continue with its test routines.

If you wish to enter the UEFI SETUP UTILITY after POST, restart the system by pressing <Ctrl> + <Alt> + <Delete>, or by pressing the reset button on the system chassis. You may also restart by turning the system off and then back on.



Because the UEFI software is constantly being updated, the following UEFI setup screens and descriptions are for reference purpose only, and they may not exactly match what you see on your screen.

3.1.1 UEFI Menu Bar

The top of the screen has a menu bar with the following selections:

Item	Description
Main	To set up the system time/date information
Advanced	To set up the advanced UEFI features
Security	To set up the security features
Boot	To set up the default system device to locate and load the Operating System
Exit	To exit the current screen or the UEFI SETUP UTILITY

Use <←→> key or <→> key to choose among the selections on the menu bar, and then press <Enter> to get into the sub screen.

3.1.2 Navigation Keys

Please check the following table for the function description of each navigation key.

Navigation Key(s)	Function Description
← / →	Moves cursor left or right to select Screens
↑ / ↓	Moves cursor up or down to select items
+ / -	To change option for the selected items
<Tab>	Switch to next function
<Enter>	To bring up the selected screen
<PGUP>	Go to the previous page
<PGDN>	Go to the next page
<HOME>	Go to the top of the screen
<END>	Go to the bottom of the screen
<F1>	To display the General Help Screen
<F7>	Discard changes and exit the UEFI SETUP UTILITY
<F9>	Load optimal default values for all the settings
<F10>	Save changes and exit the UEFI SETUP UTILITY
<F12>	Print screen
<ESC>	Jump to the Exit Screen or exit the current screen

3.2 Main Screen

Once you enter the UEFI SETUP UTILITY, the Main screen will appear and display the system overview. The Main screen provides system overview information and allows you to set the system time and date.

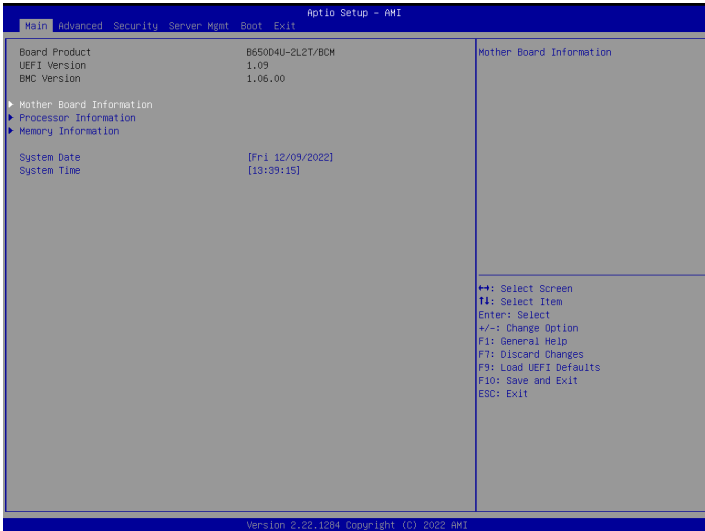

Because the UEFI software is constantly being updated, the following UEFI setup screens and descriptions for reference purpose only, and may vary from the latest BIOS and do not exactly match what you see on your screen.

3.2.1 Motherboard Information

Press [Enter] to view the information of the motherboard.

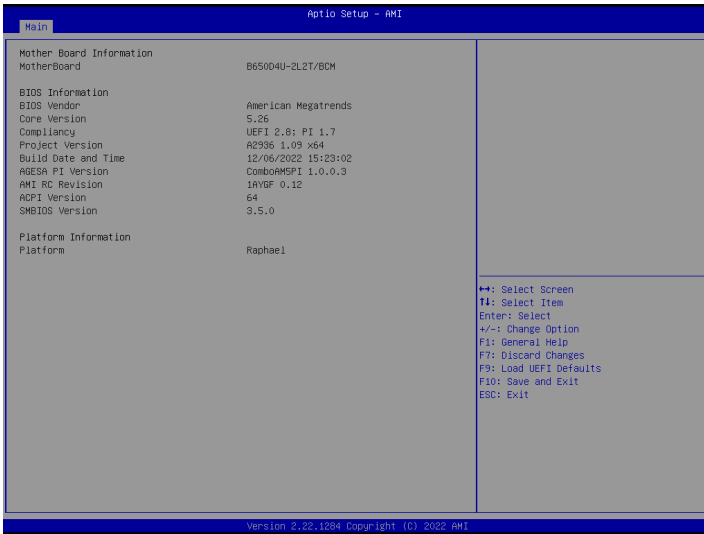

3.2.2 Processor Information

Press [Enter] to view the information of the processor.

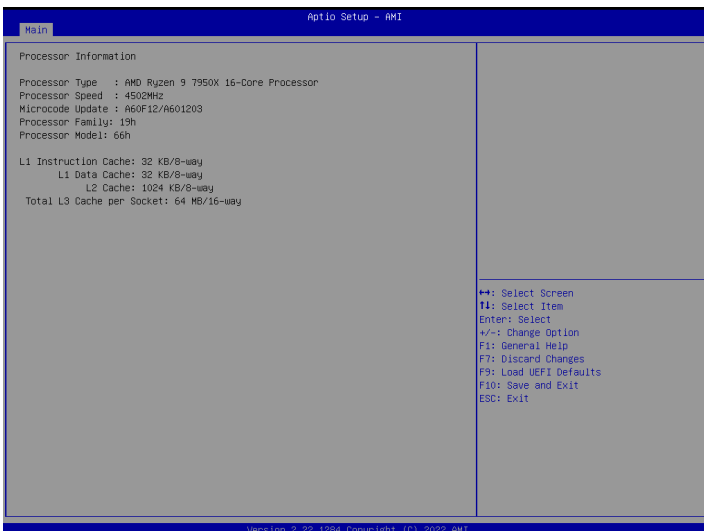

3.2.3 Memory Information

Press [Enter] to view the information of the memory.

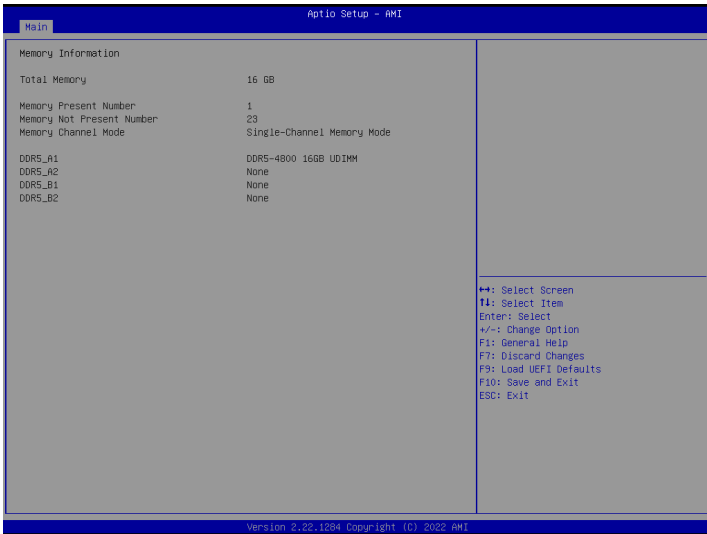

3.3 Advanced Screen

In this section, you may set the configurations for the following items: CPU Configuration, Chipset Configuration, Storage Configuration, NVMe Configuration, ACPI Configuration, USB Configuration, Super IO Configuration, Serial Port Console Redirection, H/W Monitor, PCI Subsystem Settings, AMD CBS, Network Stack Configuration, Driver Health, Tls Auth Configuration, AMD PBS, AMD Overclocking, Intel(R) I210 Gigabit Network Connection, VLAN Configuration, MAC Network Configurations, and Broadcom NetXtreme-E 2Px10GBASE-T OCP 3.0 Ethernet.

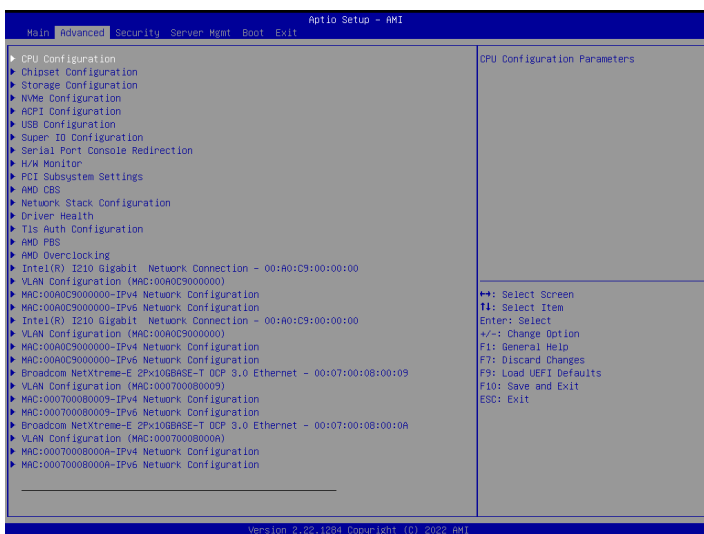

Setting wrong values in this section may cause the system to malfunction.

3.3.1 CPU Configuration

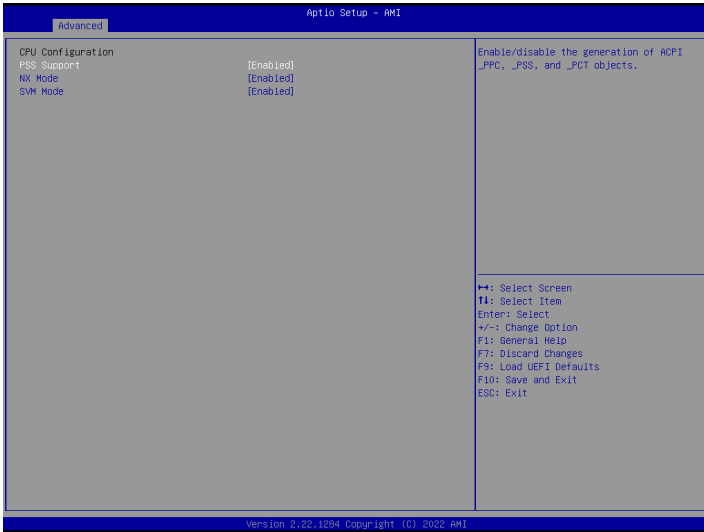

PSS Support

Use this item to enable or disable the generation of ACPI _PPC, _PSS, and _PCT objects.

NX Mode

Use this item to enable or disable No-execute page protection Function.

SVM Mode

Use this item to enable or disable CPU Virtualization.

3.3.2 Chipset Configuration

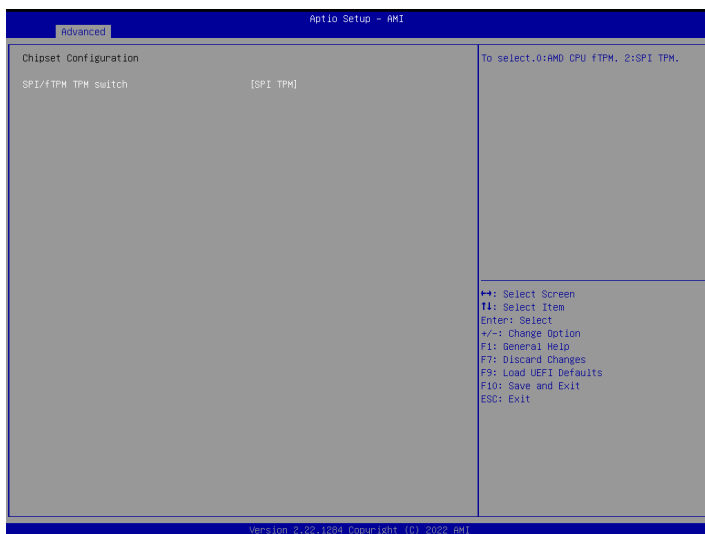

SPI/fTPM TPM Switch

To select 0:AMD CPU fTPM or 2: SPI TPM.

3.3.3 Storage Configuration

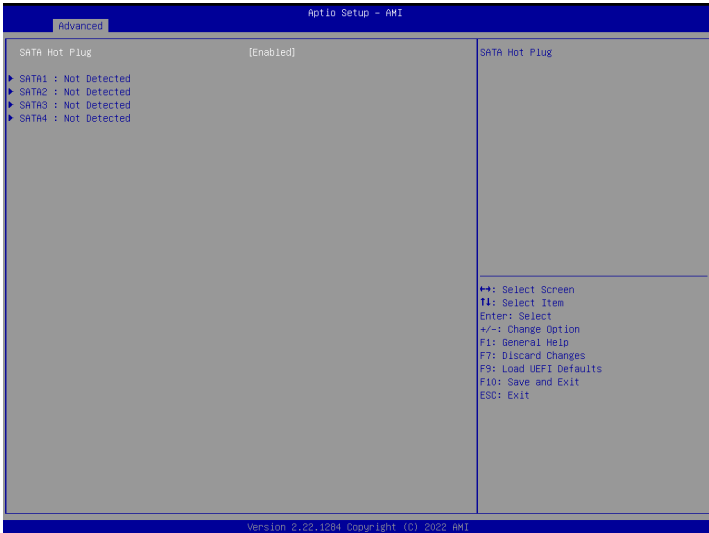

SATA Hot Plug

Use this item to enable or disable SATA Hot Plug.

3.3.4 NVMe Configuration

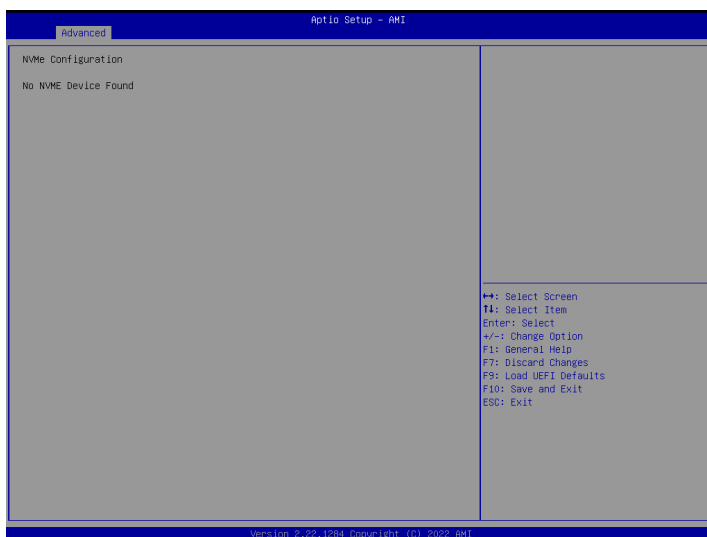

NVMe Configuration

The NVMe Configuration displays the NVMe controller and Drive information.

3.3.5 ACPI Configuration

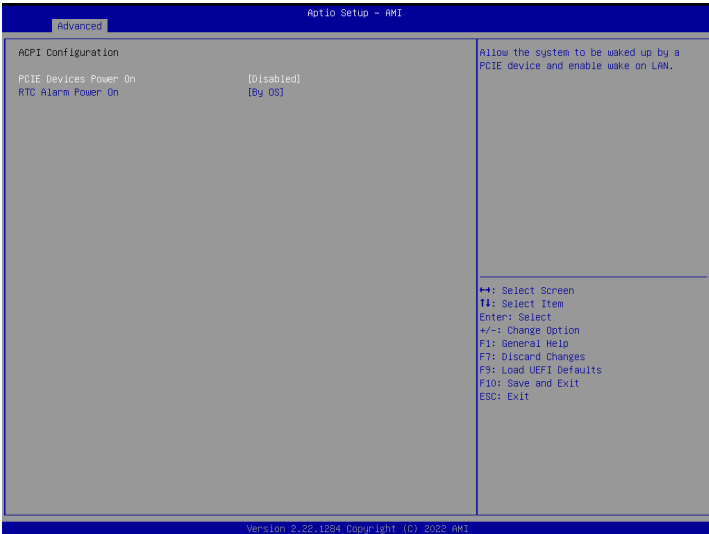

PCIe Devices Power On

This Allows the system to be waked up by a PCIe device and enable wake on LAN.

RTC Alarm Power On

This Allows the system to be waked up by the real time clock alarm. Set it to By OS to let it be handled by your operating system.

3.3.6 USB Configuration

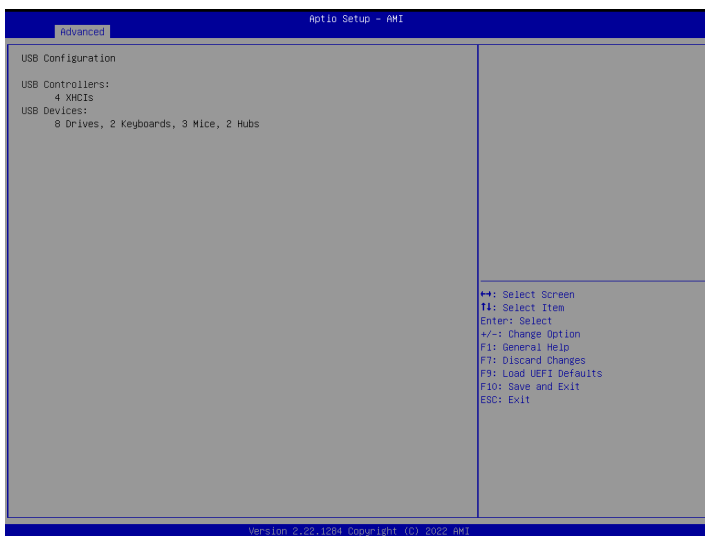

USB Configuration

The USB Configuration displays the USB Controllers and USB Device informations.

3.3.7 Super IO Configuration

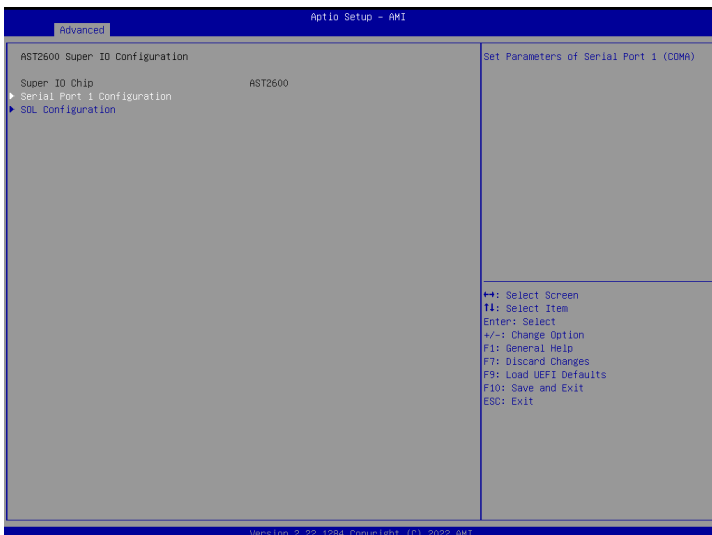

Serial Port 1 Configuration

Use this item to set parameters of Serial Port 1 (COM1).

Serial Port

Use this item to enable or disable the serial port.

Serial Port Address

Use this item to select an optimal setting for Super IO device.

SOL Configuration

Use this item to set parameters of SOL.

SOL Port

Use this item to enable or disable SOL Port.

Serial Port Address

Use this item to select an optimal setting for Super IO device.

3.3.8 Serial Port Console Redirection

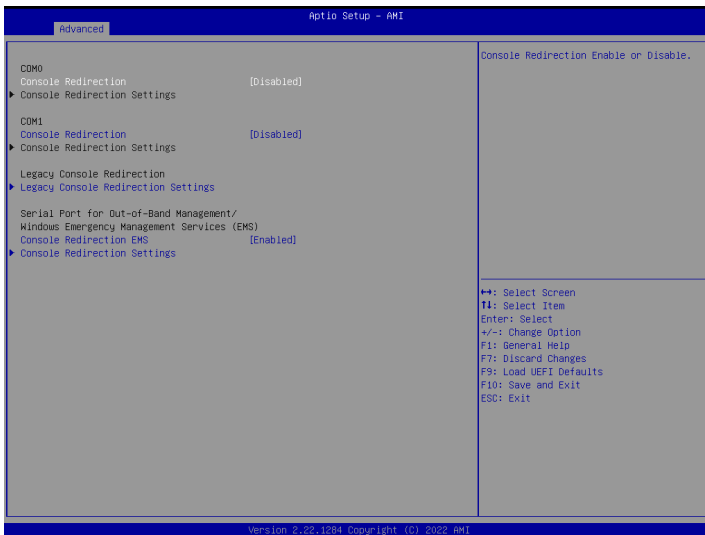

COM0 / COM1

Console Redirection

Use this option to enable or disable Console Redirection. If this item is set to Enabled, you can select a COM Port to be used for Console Redirection.

Console Redirection Settings

Use this option to configure Console Redirection Settings, and specify how your computer and the host computer to which you are connected exchange information. Both computers should have the same or compatible settings.

Terminal Type

Use this item to select the preferred terminal emulation type for out-of-band management. It is recommended to select [VT-UTF8].

Option	Description
VT100	ASCII character set
VT100+	Extended VT100 that supports color and function keys
VT-UTF8	UTF8 encoding is used to map Unicode chars onto 1 or more bytes
ANSI	Extended ASCII character set

Bits Per Second

Use this item to select the serial port transmission speed. The speed used in the host computer and the client computer must be the same. Long or noisy lines may require lower transmission speed. The options include [9600], [19200], [38400], [57600] and [115200].

Data Bits

Use this item to set the data transmission size. The options include [7] and [8] (Bits).

Parity

Use this item to select the parity bit. The options include [None], [Even], [Odd], [Mark] and [Space].

Stop Bits

The item indicates the end of a serial data packet. The standard setting is [1] Stop Bit. Select [2] Stop Bits for slower devices.

Flow Control

Use this item to set the flow control to prevent data loss from buffer overflow. When sending data, if the receiving buffers are full, a "stop" signal can be sent to stop the data flow. Once the buffers are empty, a "start" signal can be sent to restart the flow. Hardware flow uses two wires to send start/stop signals. The options include [None] and [Hardware RTS/CTS].

VT-UTF8 Combo Key Support

Use this item to enable or disable the VT-UTF8 Combo Key Support for ANSI/VT100 terminals.

Recorder Mode

Use this item to enable or disable Recorder Mode to capture terminal data and send it as text messages.

Resolution 100x31

Use this item to enable or disable extended terminal resolution support.

Putty Keypad

Use this item to select Function Key and Keypad on Putty.

Legacy Console Redirection

Legacy Console Redirection Settings

Use this option to configure Legacy Console Redirection Settings, and specify how your computer and the host computer to which you are connected exchange information.

Redirection COM Port

Select a COM port to display redirection of Legacy OS and Legacy OPROM Messages.

Resolution

On Legacy OS, the Number of Rows and Columns supported redirection.

Redirect After POST

When Bootloader is selected, then Legacy Console Redirection is disabled before booting to legacy OS. When Always Enable is selected, then Legacy Console Redirection is enabled for legacy OS. Default setting for this option is set to Always Enable.

Serial Port for Out-of-Band Management/Windows Emergency Management Services (EMS)

Console Redirection

Use this option to enable or disable Console Redirection. If this item is set to Enabled, you can select a COM Port to be used for Console Redirection.

Console Redirection Settings

Use this option to configure Console Redirection Settings, and specify how your computer and the host computer to which you are connected exchange information.

Out-of-Band Mgmt Port

Microsoft Windows Emergency Management Services (EMS) allows for remote management of a Windows Server OS through a serial port.

Terminal Type EMS

Use this item to select the preferred terminal emulation type for out-of-band management. It is recommended to select [VT-UTF8].

Option	Description
VT100	ASCII character set
VT100+	Extended VT100 that supports color and function keys
VT-UTF8	UTF8 encoding is used to map Unicode chars onto 1 or more bytes
ANSI	Extended ASCII character set

Bits Per Second EMS

Use this item to select the serial port transmission speed. The speed used in the host computer and the client computer must be the same. Long or noisy lines may require lower transmission speed. The options include [9600], [19200], [57600] and [115200].

Flow Control EMS

Use this item to set the flow control to prevent data loss from buffer overflow. When sending data, if the receiving buffers are full, a "stop" signal can be sent to stop the data flow. Once the buffers are empty, a "start" signal can be sent to restart the flow. Hardware flow uses two wires to send start/stop signals. The options include [None], [Hardware RTS/CTS], and [Software Xon/Xoff].

Data Bits

Parity

Stop Bits

3.3.9 H/W Monitor

In this section, it allows you to monitor the status of the hardware on your system, including the parameters of the CPU temperature, motherboard temperature, CPU fan speed, chassis fan speed, and the critical voltage.

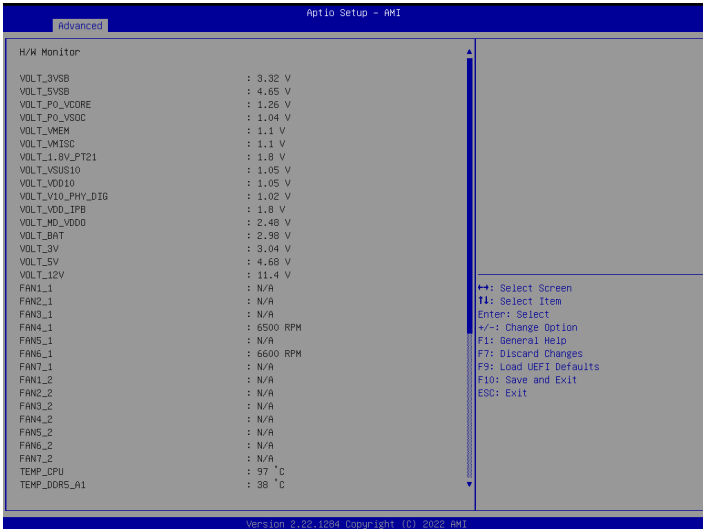

3.3.10 PCI Subsystem Settings



Above 4G Decoding

Use this item to enable or disable 64bit capable Devices to be decoded in Above 4G Address Space (only if the system supports 64 bit PCI decoding).

Re-Size BAR Support

If system has Resizable BAR capable PCIe Devices, this option Enables/Disables Resizable BAR support.

SR-IOV Support

If system has SR-IOV capable PCIe Devices, this option Enables/Disables Single Root IO Virtualization Support.

BME DMA Mitigation

Re-enable Bus Master Attribute disabled during Pci enumeration for PCI Bridges after SMM Locked.

Hot-Plug Support

Use this item to enable or disable Hot-Plug support for the entire system. If System has Hot-Plug capable Slots and this option set to Enabled, it provides a Setup screen for selecting PCI resource padding for Hot-Plug.



*Changing PCI Device(s) settings may have unwanted side effects! System may HANG!
 PROCEED WITH CAUTION.*

3.3.11 AMD CBS

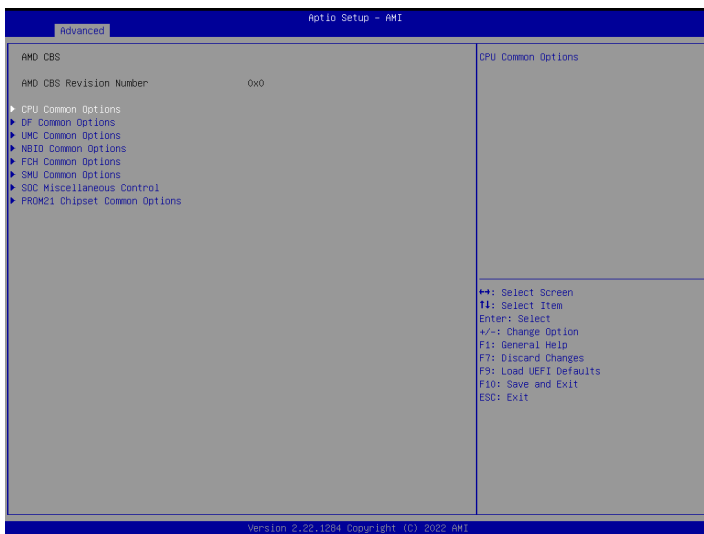

CPU Common Options

Use this item to configure CPU common options.

DF Common Options

Use this item to configure DF common options.

UMC Common Options

Use this item to configure UMC common options.

NBIO Common Options

Use this item to configure NBIO common options.

FCH Common Options

Use this item to configure FCH common options.

SMU Common Options

Use this item to configure SMU common options.

SOC Miscellaneous Control

Use this item to configure SOC Miscellaneous control options.

PROM21 Chipset Common Options

Use this item to configure PROM21 Chipset common options.

3.3.12 Network Stack Configuration

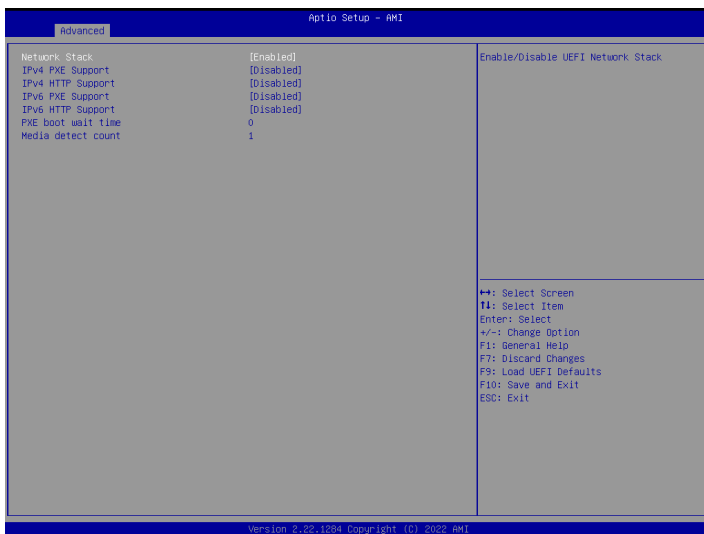

Network Stack

Enable UEFI network stack can prevents you from performing single-user network boots and network installation. If disabled, the host does not use the network interface.

IPv4 PXE Support

Enable IPv4 PXE Boot support. If disabled, IPv4 PXE Boot Option is not supported.

IPv4 HTTP Support

Enable IPv4 HTTP Boot support. If disabled, IPv4 HTTP Boot Option is not supported.

IPv6 PXE Support

Enable IPv6 PXE Boot support. If disabled, IPv6 PXE Boot Option is not supported.

IPv6 HTTP Support

Enable IPv6 HTTP Boot support. If disabled, IPv6 HTTP Boot Option is not supported.

PXE Boot Wait Time

Specifies the wait time and press the ESC key to abort the PXE boot.

Media Detect Count

Specifies the number of times the presence of physical storage device are verified on a system reset or power cycle.

3.3.13 Driver Health

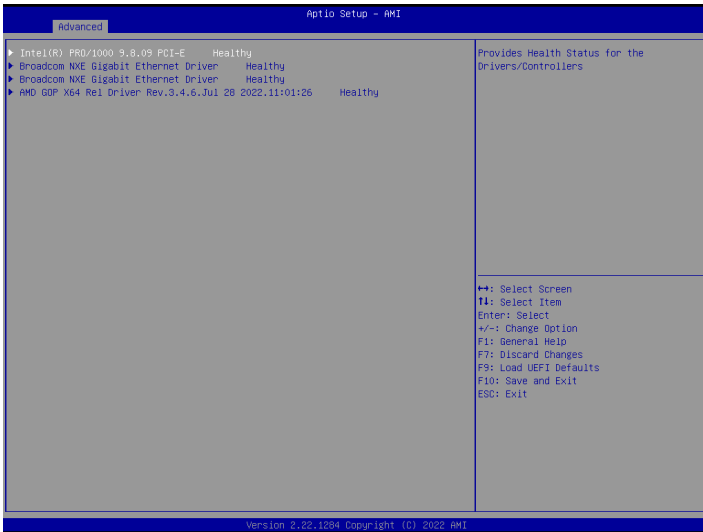

Intel(R) PRO/1000 9.8.09 PCI-E Healthy

Provides Health Status for the Drivers/Controllers.

Broadcom NXE Gigabit Ethernet Driver Healthy

Provides Health Status for the Drivers/Controllers.

Broadcom NXE Gigabit Ethernet Driver Healthy

Provides Health Status for the Drivers/Controllers.

AMD GOP X64 Rel Driver Rev.3.4.6 Jul 28 2022.11:01:26 Healthy

Provides Health Status for the Drivers/Controllers.

3.3.14 Tls Auth Configuration

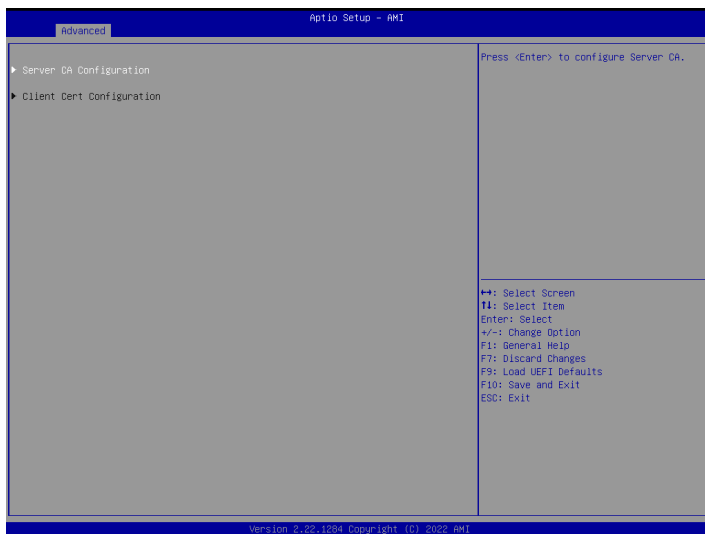

Server CA Configuration

Press [Enter] to configure Server CA.

Client Cert Configuration

Press [Enter] to configure Client Cert.

3.3.15 AMD PBS

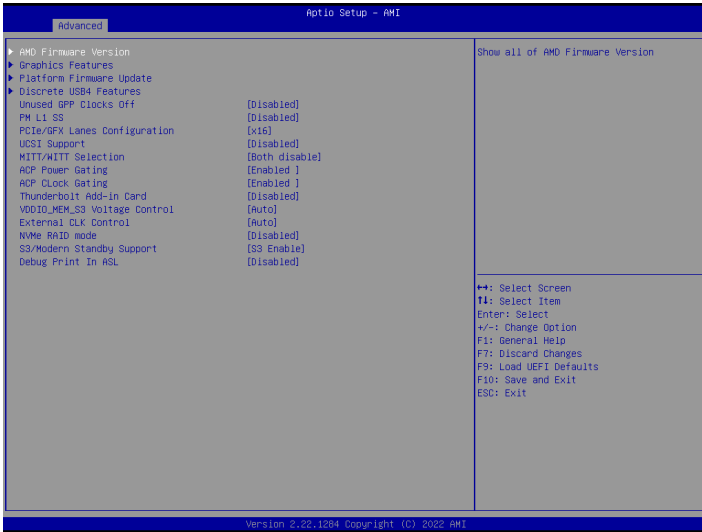

AMD Firmware Version

Show all of AMD Firmware Version.

Graphics Features

Graphics Features - HG, DGPU Features, BOMAC0.

Platform Firmware Update

Use this item to process Platform Firmware Update

Discrete USB4 Features

Discrete USB4 Features - PCIe resource, D3 support, Native USB4 support and so on.

Unused GPP Clocks Off

Turn Unused GPP Clocks Off.

PM L1 SS

Enable for PM L1 SS and ASPM L1 SS.

UCSI Support

Enable for UCSI (USB Type-C Connector System Software Interface).

MITT/WITT Selection

Use this item to configure MITT/WITT Selection

ACP Power Gating

Use this item to enable or disable ACP Power Gating.

ACP Lock Gating

Use this item to enable or disable ACP CLOCK Gating.

Thunderbolt Add-in Card

Enable Thunderbolt AR/TR Add-in Card Support.

VDDIO_MEM_S3 Voltage Control

Use this item to configure voltage control for VDDIO_MEM_S3 with Auto or Manual selections.

External CLK Control

Use the item to configure External CLK Control with Auto (100Mhz CGPLL generated by default) / eCLK0 (EXT_GPP0_SRC) or GPP1 (External input thru GPP1).



Switch APU clocks source mapping will get stuck immediately (post code: B0005A5A), manual press cold reset button to bypass the stuck.

NVMe RAID mode

Use this item to enable or disable NVMe RAID mode. Please setting the 'PCIe/GFX Lanes Configuration' item according to the RAID configuration.

S3/Modern Standby Support

Switch S3/Modern Standby.

Debug Print In ASL

Enable Debug Print In ASL.

3.3.16 AMD Overclocking

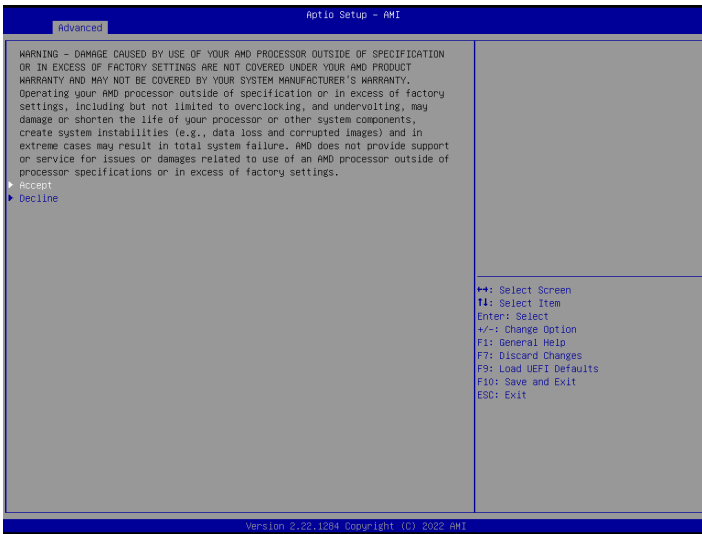

The AMD Overclocking menu accesses options for configuring CPU frequency and voltage.

3.3.17 Inter (R) I210 Gigabit Network Connection

Configure Gigabit Ethernet device parameters.

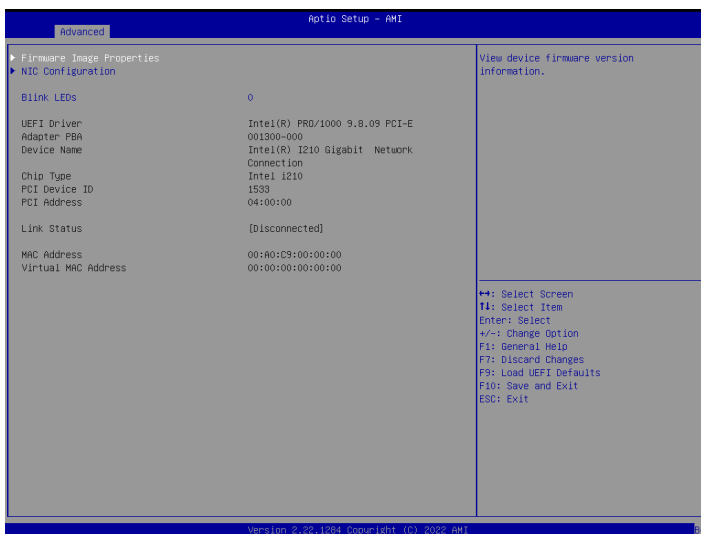

Firmware Image Properties

Enter this item to view firmware version information.

NIC Configuration

Click this item to configure the network device port.

Blink LEDs

Blink LEDs for the specified duration (up to 15 seconds)

3.3.18 VLAN Configuration

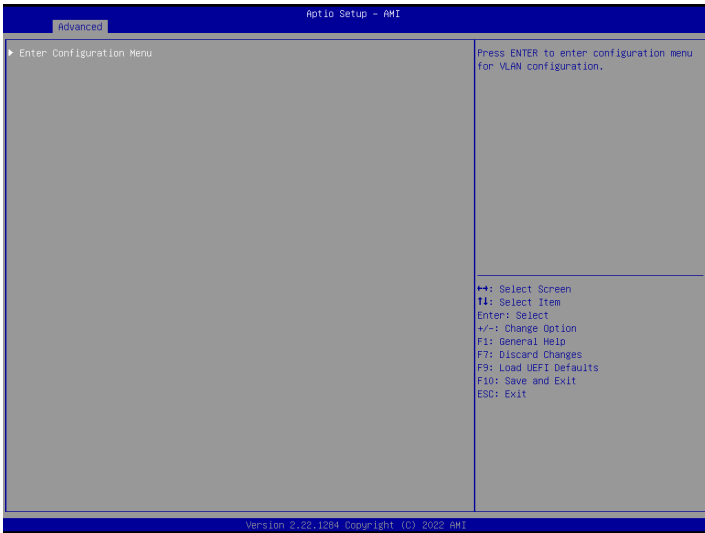

Enter Configuration Menu

Press [Enter] to enter configuration menu for VLAN configuration.

3.3.19 IPv4 Network Configuration

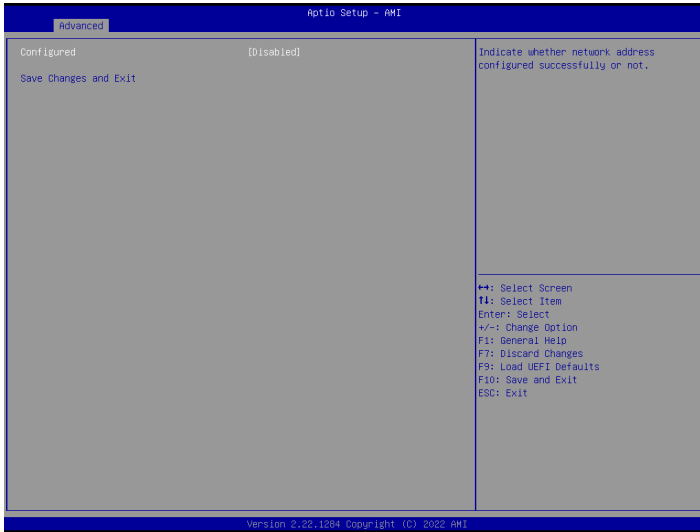

Configured

Indicate whether network address configured successfully or not.

Save Changes and Exit

Save changed value and exit.

3.3.20 IPv6 Network Configuration

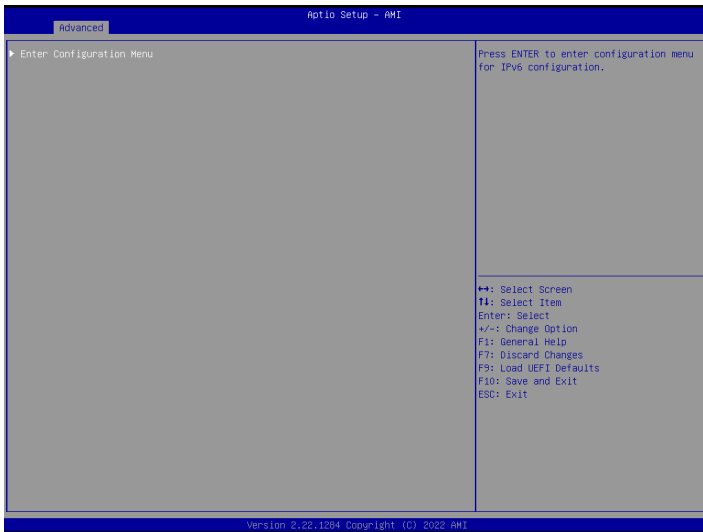

Enter Configuration Menu

Press [Enter] to enter configuration menu for IPv6 configuration.

3.3.21 Broadcom NetXtreme-E 2Px10GBASE-T OCP 3.0 Ethernet

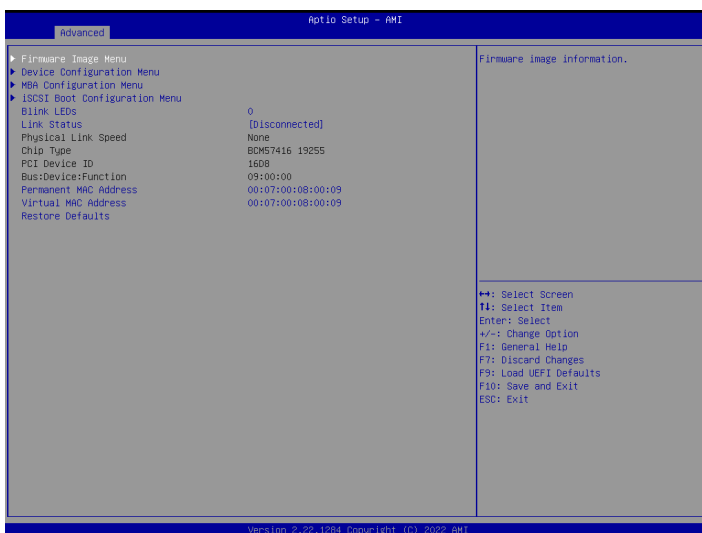

Firmware Image Menu

Enter this item to view firmware version information.

Device Configuration Menu

Enter this item to view device configuration menu.

MBA Configuration Menu

Use this item to configure Multiple Boot Agent (MBA) parameters.

iSCSI Boot Configuration Menu

Use this item to configure iSCSI boot parameters.

Blink LEDs

Blink LEDs for the specified duration (up to 15 seconds)

Link Status

Use this item to select the Link Status.

Permanent MAC Address

Use this item to configure Permanent MAC Address.

Virtual Mac Address

Use this item to configure Virtual MAC Address.

Restore Defaults

Use this item to reset adapter to factory defaults.

3.4 Security

In this section, you may set or change the supervisor/user password for the system. For the user password, you may also clear it.

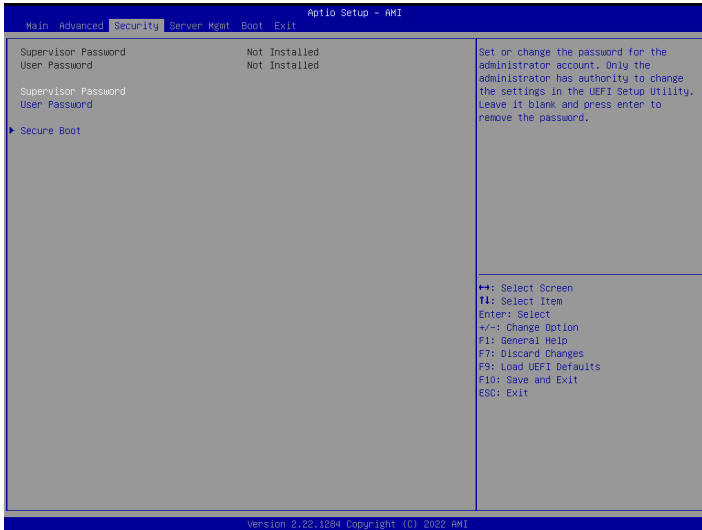

Supervisor Password

Set or change the password for the administrator account. Only the administrator has authority to change the settings in the UEFI Setup Utility. Leave it blank and press [Enter] to remove the password.

User Password

Set or change the password for the user account. Users are unable to change the settings in the UEFI Setup Utility. Leave it blank and press [Enter] to remove the password.

Secure Boot

Use this to Enable/Disable Secure Boot Control. The default value is [Enabled]. Enable to support Windows Server 2012 R2 or later versions Secure Boot.

Secure Boot Mode

Secure Boot mode options: Standard/Custom. In Custom mode, Secure Boot Policy variables can be configured without authentication.

3.4.1 Install Default Secure Boot Keys

Please install default secure boot keys if it is the first time you use secure boot. Select Clear Secure Boot keys item to clear the assigned secure boot keys.

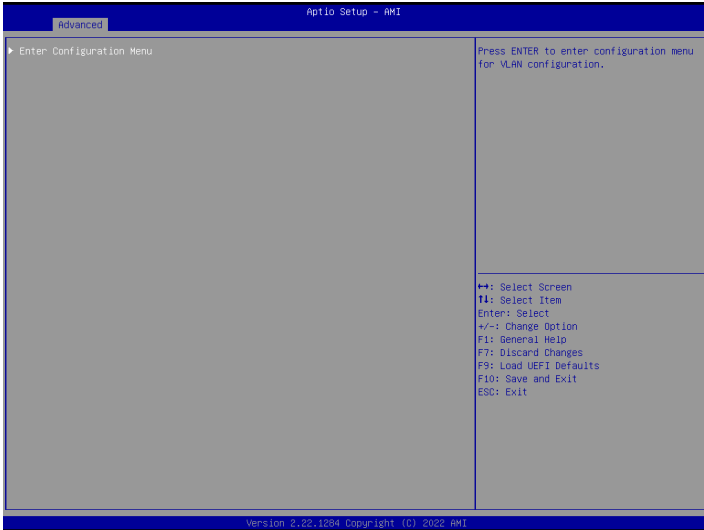

3.4.2 Key Management

In this section, expert users can modify Secure Boot Policy variables without full authentication.

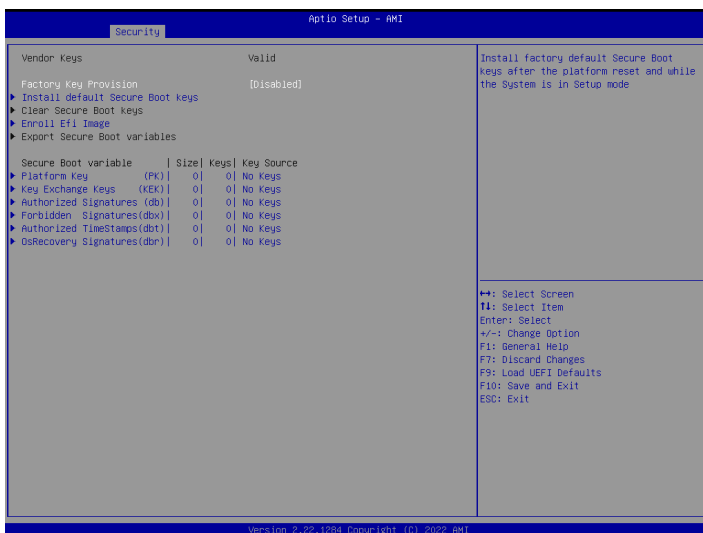

Factory Key Provision

Install factory default Secure Boot Keys after the platform reset and while the system is in Setup mode.

Install Default Secure Boot Keys

Please install default secure boot keys if it's the first time you use secure boot.

Clear Secure Boot Keys

Force System to Setup Mode - clear all Secure Boot Variables. Change takes effect after reboot.

Enroll Efi Image

Allow the image to run in Secure Boot mode. Enroll SHA256 hash of the binary into Authorized Signature Database (db).

Export Secure Boot Variables

Copy NVRAM content of Secure Boot variables to files in a root folder on a file system device.

Platform Key (PK)

Enroll Factory Defaults or load certificates from a file:

1. Public Key Certificate in:
 - a) EFI_SIGNATURE_LIST
 - b) EFI_CERT_X509 (DER)
 - c) EFI_CERT_RSA2048 (bin)
 - d) EFI_CERT_SHAXXX
2. Authenticated UEFI Variable
3. EFI PE/COFF Image(SHA256)

Key Source: Factory, Modified, Mixed

Key Exchange Keys (KEK)

Enroll Factory Defaults or load certificates from a file:

1. Public Key Certificate in:
 - a) EFI_SIGNATURE_LIST
 - b) EFI_CERT_X509 (DER)
 - c) EFI_CERT_RSA2048 (bin)
 - d) EFI_CERT_SHAXXX
2. Authenticated UEFI Variable
3. EFI PE/COFF Image(SHA256)

Key Source: Factory, Modified, Mixed

Authorized Signatures (db)

Enroll Factory Defaults or load certificates from a file:

1. Public Key Certificate in:
 - a) EFI_SIGNATURE_LIST
 - b) EFI_CERT_X509 (DER)
 - c) EFI_CERT_RSA2048 (bin)
 - d) EFI_CERT_SHAXXX

2. Authenticated UEFI Variable
3. EFI PE/COFF Image(SHA256)

Key Source: Factory, Modified, Mixed

Forbidden Signatures (dbx)

Enroll Factory Defaults or load certificates from a file:

1. Public Key Certificate in:

- a) EFI_SIGNATURE_LIST
- b) EFI_CERT_X509 (DER)
- c) EFI_CERT_RSA2048 (bin)
- d) EFI_CERT_SHAXXX

2. Authenticated UEFI Variable
3. EFI PE/COFF Image(SHA256)

Key Source: Factory, Modified, Mixed

Authorized TimeStamps (dbt)

Enroll Factory Defaults or load certificates from a file:

1. Public Key Certificate in:

- a) EFI_SIGNATURE_LIST
- b) EFI_CERT_X509 (DER)
- c) EFI_CERT_RSA2048 (bin)
- d) EFI_CERT_SHAXXX

2. Authenticated UEFI Variable
3. EFI PE/COFF Image(SHA256)

Key Source: Factory, Modified, Mixed

OsRecovery Signatures (dbr)

Enroll Factory Defaults or load certificates from a file:

1. Public Key Certificate in:

- a) EFI_SIGNATURE_LIST

b) EFI_CERT_X509 (DER)

c) EFI_CERT_RSA2048 (bin)

d) EFI_CERT_SHAXXX

2. Authenticated UEFI Variable

3. EFI PE/COFF Image(SHA256)

Key Source: Factory, Modified, Mixed

3.5 Server Mgmt

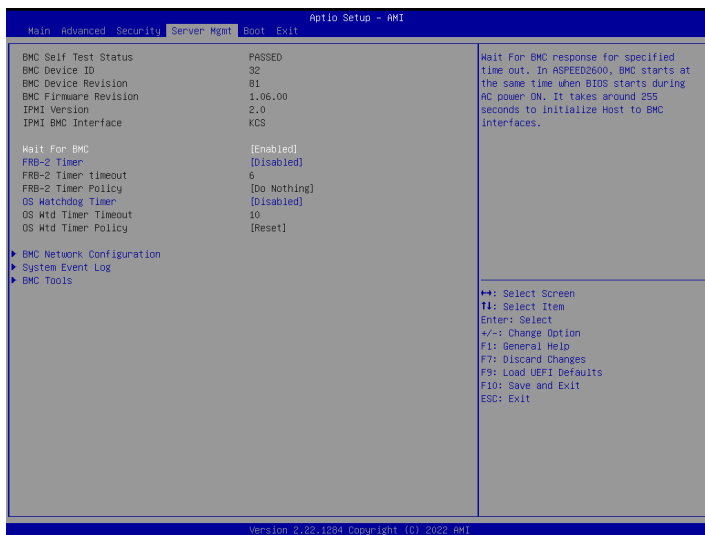

Wait For BMC

Wait For BMC response for specified time out. BMC starts at the same time when BIOS starts during AC power ON. It takes around 90 seconds to initialize Host to BMC interfaces.

FRB-2 Timer

Use this item to enable or disable FRB-2 timer (POST timer).

FRB-2 Timer Timeout

Enter value between 1 to 30 min for FRB-2 Timer Expiration.

FRB-2 Timer Policy

Use this item to configure how the system should respond if the FRB-2 Timer expires. Not available if FRB-2 Timer is disabled.

OS Watchdog Timer

If enabled, starts a BIOS timer which can only be shut off by Management Software after the OS loads. Helps determine that the OS successfully loaded or follows the OS Boot Watchdog Timer policy.

OS Wtd Timer Timeout

Enter value between 1 to 30 min for OS Boot Watchdog Timer Expiration. Not available if OS BootWatchdog Timer is disabled.

OS Wtd Timer Policy

Use this item to configure how the system should respond if the OS Watchdog Timer expires. Not available if OS Boot Watchdog Timer is disabled.

3.5.1 BMC Network Configuration

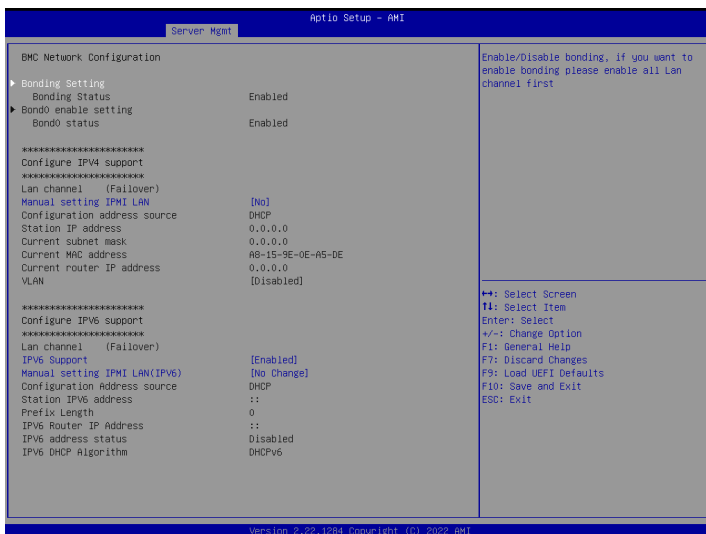

Bonding Setting

Use this item to enable or disable bonding. If you want to enable bonding, please enable all Lan channels first.

BMC Out of Band Access

Use this item to enable or disable BMC Out of band Access.

Lan channel (Failover)

Manual Setting IPMI LAN

If [No] is selected, the IP address is assigned by DHCP. If you prefer using a static IP address, toggle to [Yes], and the changes take effect after the system reboots. The default value is [No].

Configuration Address Source

Select to configure BMC network parameters statically or dynamically (by BIOS or BMC). Configuration options: [Static] and [DHCP].

Static: Manually enter the IP Address, Subnet Mask and Gateway Address in the BIOS for BMC LAN channel configuration.

DHCP: IP address, Subnet Mask and Gateway Address are automatically assigned by the network's DHCP server.



When [DHCP] or [Static] is selected, do NOT modify the BMC network settings on the IPMI web page.



The default login information for the IPMI web interface is:

Username: admin

Password: admin

For more instructions on how to set up remote control environment and use the IPMI management platform, please refer to the IPMI Configuration User Guide or go to the Support website at: <http://www.asrockrack.com/support/faq.asp>

VLAN

Enabled/Disabled Virtual Local Area Network.

If [Enabled] is selected, configure the items below.

IPV6 Support

Enabled/Disable LAN1 IPV6 Support.

Manual Setting IPMI LAN(IPV6)

Select to configure LAN channel parameters statically or dynamically(by BIOS or BMC).

Unspecified option will not modify any BMC network parameters during BIOS phase.

IPV6 Index

IPV6 Index - Set Selector for Static IP, range 0 to 15.

3.5.2 System Event Log

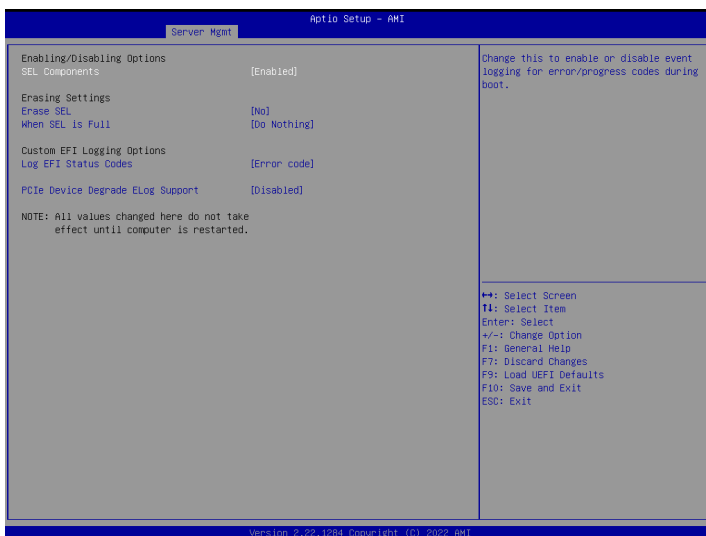

SEL Components

Change this to enable or disable event logging for error/progress codes during boot.

Erase SEL

Use this to choose options for erasing SEL.

When SEL is Full

Use this to choose options for reactions to a full SEL.

Log EFI Status Codes

Use this item to disable the logging of EFI Status Codes or log only error code or only progress code or both.

PCIe Device Degrade ELog Support

Use this item to enable or disable PCIe Device Degrade Error Logging Support.

3.5.3 BMC Tools

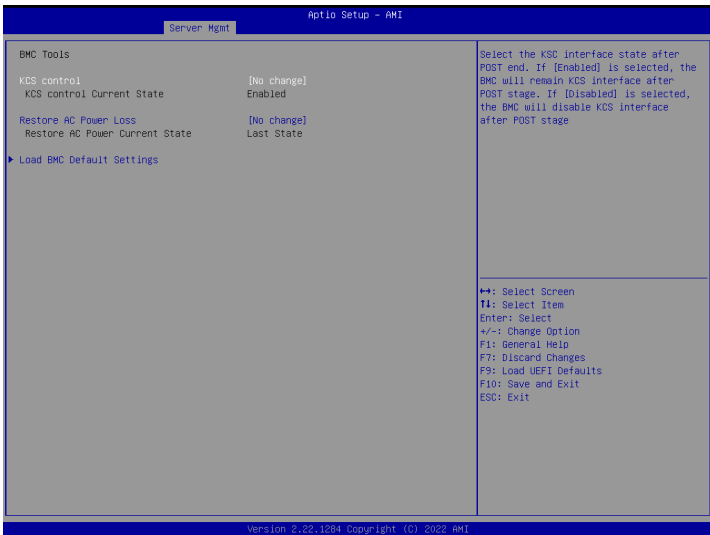

KCS Control

Select this KCS interface state after POST end. If [Enabled] is selected, the BMC will remain KCS interface after POST stage. If [Disabled] is selected, the BMC will disable KCS interface after POST stage.

Restore AC Power Loss

Select the power state after a power failure. If [Power Off] is selected, the power will remain off when the power recovers. If [Power On] is selected, the system will start to boot up when the power recovers.

Load BMC Default Settings

Use this item to Load BMC Default Settings

3.6 Boot Screen

In this section, it will display the available devices on your system for you to configure the boot settings and the boot priority.

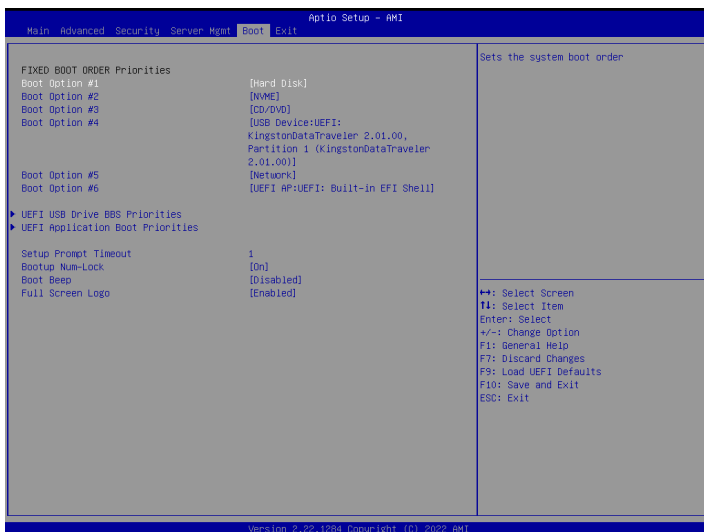

Boot Option

Use this item to set the system boot order.

UEFI USB Device BBS Priorities

Use this item to set the order of the legacy devices in the group.

UEFI Application Boot Priorities

Use this item to specifies the Boot Device Priority sequence from available UEFI Application.

Setup Prompt Timeout

Configure the number of seconds to wait for the UEFI setup utility.

Bootup Num-Lock

Select whether Num Lock should be turned on or off when the system boots up.

Boot Beep

Select whether the Boot Beep should be turned on or off when the system boots up. Please note that a buzzer is needed.

Full Screen Logo

Enable to display the boot logo or disable to show normal POST messages.

3.7 Exit Screen

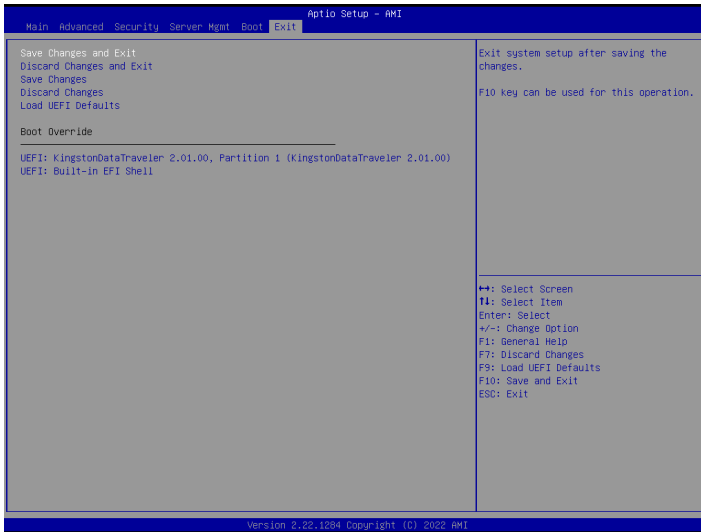

Save Changes and Exit

When you select this option, the following message “Save configuration changes and exit setup?” will pop-out. Press <F10> key or select [Yes] to save the changes and exit the UEFI SETUP UTILITY.

Discard Changes and Exit

When you select this option, the following message “Discard changes and exit setup?” will pop-out. Press <ESC> key or select [Yes] to exit the UEFI SETUP UTILITY without saving any changes.

Save Changes

When you select this option, the following message “Save changes?” will pop-out. Press <F7> key or select [Yes] to save all changes.

Discard Changes

When you select this option, the following message “Discard changes?” will pop-out. Press <F7> key or select [Yes] to discard all changes.

Load UEFI Defaults

Load UEFI default values for all the setup questions. F9 key can be used for this operation.

Boot Override

These items displays the available devices. Select an item to start booting from the selected device.

Chapter 4 Software Support

After all the hardware has been installed, we suggest you go to our official website at <http://www.ASRockRack.com> and make sure if there are any new updates of the BIOS / BMC firmware for your motherboard.

4.1 Download and Install Operating System

This motherboard supports various Microsoft® Windows® Server / Linux compliant operating systems. Please download the operating system from your OS manufacturer. Please refer to your OS documentation for more instructions.

** Please download the Intel® SATA Floppy Image driver from the ASRock Rack's website (www.asrockrack.com) to your USB drive while installing OS in SATA RAID mode.*

4.2 Download and Install Software Drivers

This motherboard supports various Microsoft® Windows® compliant drivers. Please download the required drivers from our website at <http://www.ASRockRack.com>.

To download necessary drivers, go to the product page, click on the "Download" tab, choose the operating system you use, and select the driver you need to be downloaded.

4.3 Contact Information

If you need to contact ASRock Rack or want to know more about ASRock Rack, welcome to visit ASRock Rack's website at <http://www.ASRockRack.com>; or you may contact your dealer for further information.

Chapter 5 Troubleshooting

5.1 Troubleshooting Procedures

Follow the procedures below to troubleshoot your system.



Always unplug the power cord before adding, removing or changing any hardware components. Failure to do so may cause physical injuries to you and damages to motherboard components.

1. Disconnect the power cable and check whether the PWR LED is off.
2. Unplug all cables, connectors and remove all add-on cards from the motherboard. Make sure that the jumpers are set to default settings.
3. Confirm that there are no short circuits between the motherboard and the chassis.
4. Install a CPU and fan on the motherboard, then connect the chassis speaker and power LED.

If there is no power...

1. Confirm that there are no short circuits between the motherboard and the chassis.
2. Make sure that the jumpers are set to default settings.
3. Check the settings of the 115V/230V switch on the power supply.
4. Verify if the battery on the motherboard provides ~3VDC. Install a new battery if it does not.

If there is no video...

1. Try replugging the monitor cables and power cord.
2. Check for memory errors.

If there are memory errors...

1. Verify that the DIMM modules are properly seated in the slots.
2. Use recommended DDR4 DDR4 RDIMM/ RDIMM-3DS/ LRDIMM/ LRDIMM-3DS/ NVDIMM modules.
3. If you have installed more than one DIMM modules, they should be identical with the same brand, speed, size and chip-type.
4. Try inserting different DIMM modules into different slots to identify faulty ones.
5. Check the settings of the 115V/230V switch on the power supply.

Unable to save system setup configurations...

1. Verify if the battery on the motherboard provides ~3VDC. Install a new battery if it does not.
2. Confirm whether your power supply provides adequate and stable power.

Other problems...

1. Try searching keywords related to your problem on ASRock Rack's FAQ page:
<http://www.asrockrack.com/support>

5.2 Technical Support Procedures

If you have tried the troubleshooting procedures mentioned above and the problems are still unsolved, please contact ASRock Rack's technical support with the following information:

1. Your contact information
2. Model name, BIOS version and problem type.
3. System configuration.
4. Problem description.

You may contact ASRock Rack's technical support at:
<http://www.asrockrack.com/support/tsd.asp>

5.3 Returning Merchandise for Service

For warranty service, the receipt or a copy of your invoice marked with the date of purchase is required. By calling your vendor or going to our RMA website (<http://event.asrockrack.com/tsd.asp>) you may obtain a Returned Merchandise Authorization (RMA) number. The RMA number should be displayed on the outside of the shipping carton which is mailed prepaid or hand-carried when you return the motherboard to the manufacturer. Shipping and handling charges will be applied for all orders that must be mailed when service is complete.

This warranty does not cover damages incurred in shipping or from failure due to alteration, misuse, abuse or improper maintenance of products.

Contact your distributor first for any product related problems during the warranty period.

Contact Information

If you need to contact ASRock Rack or want to know more about ASRock Rack, you're welcome to visit ASRock Rack's website at <http://www.asrockrack.com>; or you may contact your dealer for further information. For technical questions, please submit a support request form at <https://event.asrockrack.com/tsd.asp>

ASRock Rack Incorporation

e-mail: ASRockRack_sales@asrockrack.com

ASRock Rack EUROPE B.V.

Bijsterhuizen 11-11

6546 AR Nijmegen

The Netherlands

Phone: +31-24-345-44-33

ASRock Rack America, Inc.

13848 Magnolia Ave, Chino, CA91710 U.S.A.

Phone: +1-909-590-8308

Fax: +1-909-590-1026