



LiDAR Navigation Robot Vacuum & Mop



4200Pa Hyper Suction
For a deeper, powerful clean

LiDAR & Gyro Dual Navi System

Higher precision mapping and navigation

Vacuum and Mop Combo

Tackles sticky messes and kitchen grease

3-Hour Continuous Clean

5000 mAh energy-dense battery†

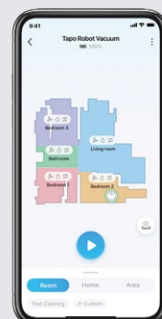

App Control



Tapo RV30

// Overview

Robot Vacuum



▶ Power/Clean

- Press once: Start/pause cleaning.
- Press and hold for 5 seconds: Turn on/off the robot vacuum.

*For the first use, slide the power switch from OFF to ON to turn on.

🏠 Dock

- Return to the dock to charge.

🗄️ Spot Cleaning/Child Lock

- Press once: Start spot cleaning.
- Press and hold for 5 seconds: Turn on/off the child lock.

🏠 + 🗄️ Combination Button

- Press and hold simultaneously for 5 seconds: Enter setup mode to configure network.
- Press and hold simultaneously for 10 seconds: Restore to factory default settings.

🏠 LED

- **Red:** Battery level < 20%; Error
- **Orange:** Battery level between 20% and 80%
- **Green:** Battery level > 80%

Overview

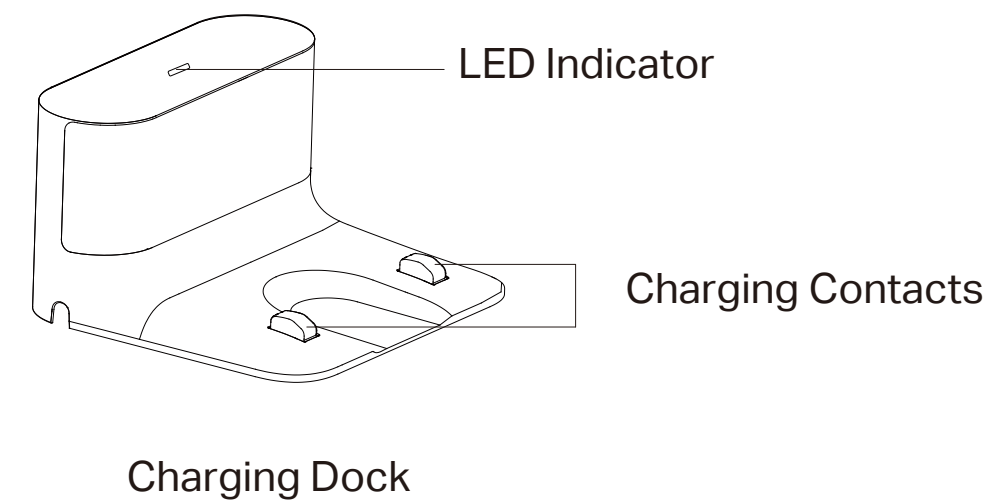
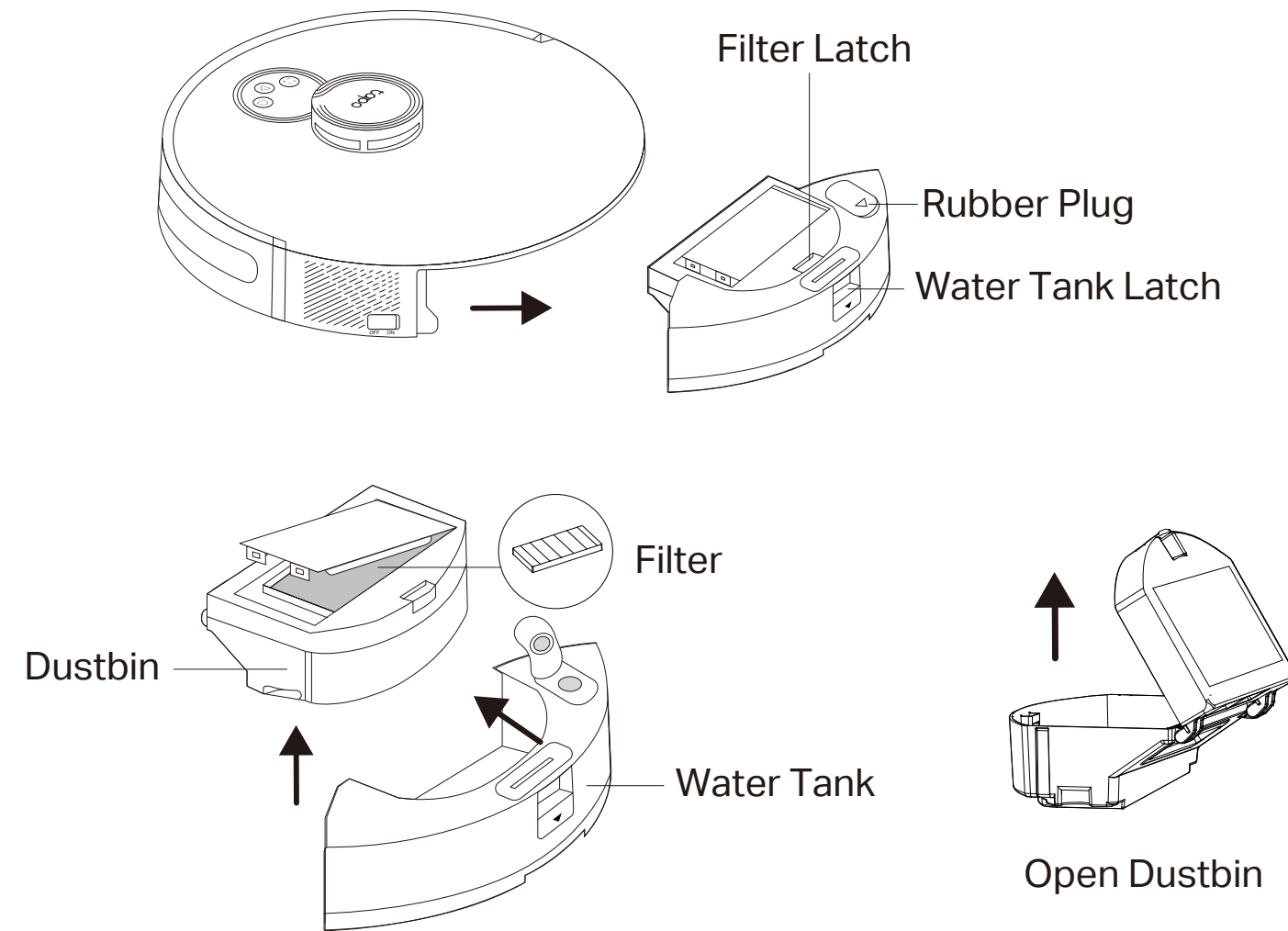
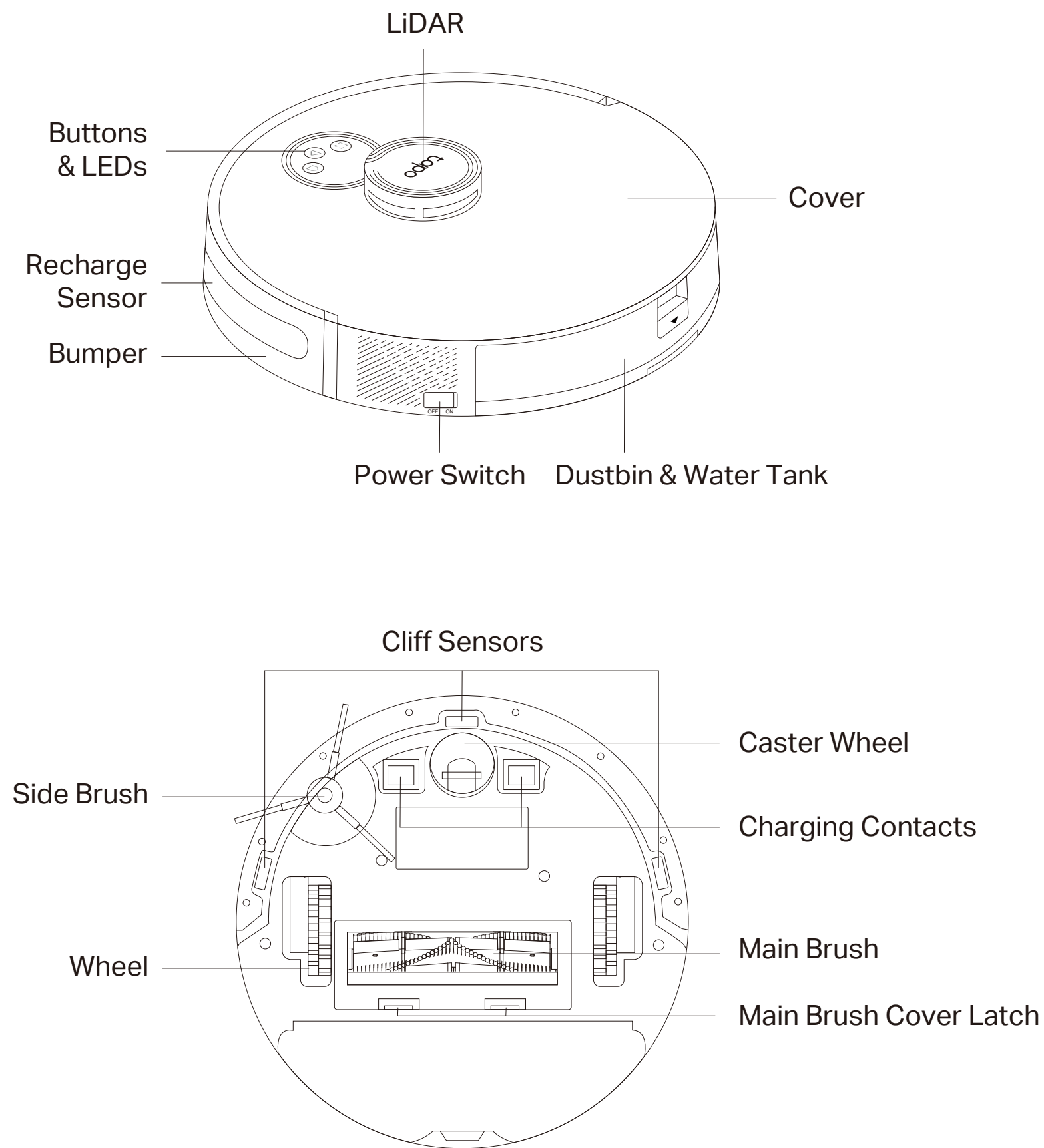

// Highlights



4200Pa Hyper Suction

With industry-leading suction power up to 4200Pa, the Tapo Robot Vacuum is designed for a deeper clean that sweeps away debris sandwiched between gaps and dust hidden in carpets, leaving nothing but a spotless floor.

3-Hour Continuous Cleaning

5000 mAh energy-dense battery powers a long-lasting, fade-free suction.[†]

Auto-Boost for Your Carpets

Automatically adjusts the suction power to the max mode when encountering carpets.

400ml Dust Bin Carries More

Holds even more debris, pet hair, and dust.



High-Precision Dual Navi System

A LiDAR and Gyro dual navigation system serves as the brain and accurately maps out your home in minutes, avoids omissions and repeated cleaning, and even works well in the dark.

Multi-Floor Local-Stored Maps

Recognizes different floors faster and accurately with 3 local-stored maps.

Obstacle Detection and Avoidance

Laser-based sensors handle complex environments flexibly.

Anti-Drop Protection

Multiple cliff sensors avoid falls down stairs and ledges.

// Highlights



Mops and Vacuums Simultaneously

Mopping is essential for houses with hard floors, which need regular polishing. Vacuuming and mopping in one trip turns your thankless chore time into me time.[§]

Huge Water Tank Capacity

A full-size 300ml water tank covers up to 200 m² / 2100 ft².[‡]

3-Level Electronic Mopping

Provides 3 water flows to suit different floor types with consistent and steady water pressure.

Wet Hard Surfaces, Dry Carpets

Set no-go zones or virtual walls via the Tapo app to keep your carpets nice and dry.

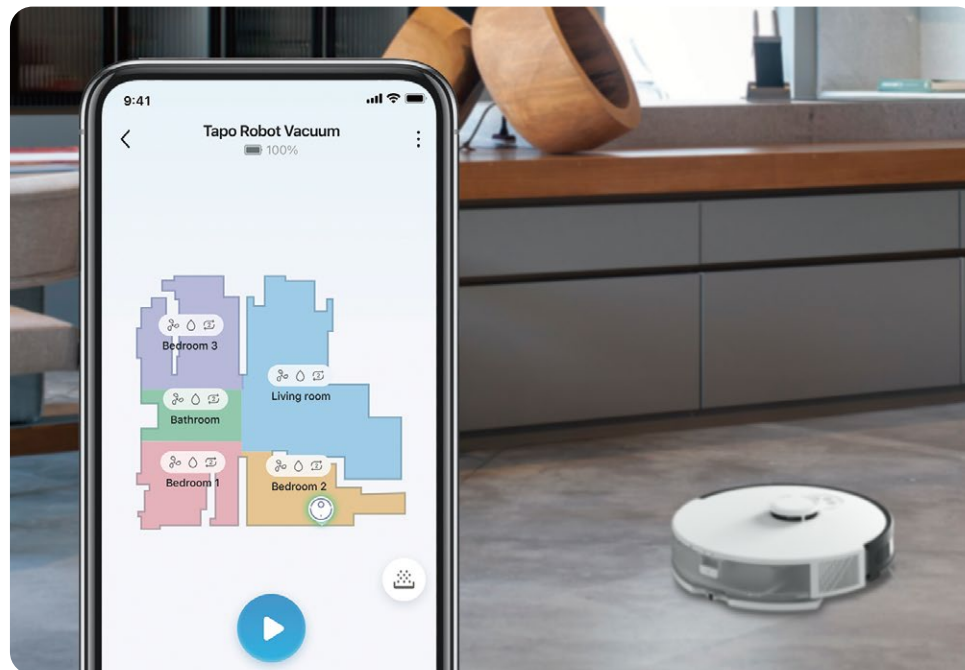

Total Control at Your Fingertips

Cleaning made simple. Manage your own cleaning schedule and monitor your robot's status at home or away with the Tapo app.

Customizable Cleaning

Merge and separate areas, name individual rooms, and customize clean modes for each room.

Virtual Walls and No-Go Zones

Set up areas you don't want the robot to go via the Tapo app.

Simple Voice Control

Pair with Alexa or Google Home to control with voice commands.

// Specifications

Care and Maintenance

To maintain optimal performance, maintain the robot vacuum according to the following guidelines.

Part	Maintenance Frequency	Replacement Frequency*
Dustbin	Clean/wash as needed	/
Filter	Once a week	3-6 months
Main Brush	Every 2 weeks	6-12 months
Side Brush	Once a month	3-6 months
Mop Cloth	After each use	2-3 months
Caster Wheel	Clean as needed	/
Main Wheels	Once a month	/
Sensors	Once a month	/
Charging Contacts	Once a month	/

*Replacement frequency may vary depending on the actual situation. Parts should be replaced if visible wear appears.

// Specifications

Mapping & Navigation Features

- Mapping/Path Planning: LiDAR + Gyroscope
- High-Precision Map: Yes
- Obstacle Avoidance: LiDAR
- Barrier-Cross Height: 20 mm/0.79 in
- Anti-Drop Protection: Yes

Vacuuming Features

- Max Suction Power: 4200Pa
- Suction Level Adjustment: 4 levels
- Dustbin Capacity: 400ml
- Dustbin Detection: Yes
- HEPA Filter: Yes
- Carpet Boost: Yes, Electricity Recognition

Mopping Features

- Wet Mopping : Yes
- Mopping Type: Electric Water Flow Control
- Water Level Adjustment: 3 levels
- Water Tank Capacity: 300ml

Battery

- Battery Capacity : 5000 mAh
- Recharge & Resume: Yes

App Features

- Real-Time Tracking: Yes
- Multi-Floor Mapping: Yes
- Scheduled Cleaning: Yes
- Virtual Walls: Yes
- No-Go Zones: Yes
- Zone Cleaning: Yes

// Specifications

Physical

- Product Dimensions:
Robot Vacuum: 342.2 × 341.8 × 95 mm (13.5 × 13.5 × 3.7 in)
- Package Contents:
Robot Vacuum Cleaner ×1
Charging Base ×1
Mop Cloth Mount ×1
Power Adapter ×1
Quick Installation Guide
Washable Mop Cloth ×2
Side Brush ×2
HEPA Filter ×2
Cleaning Brush ×1

Others

- Wireless Connection:
IEEE 802.11 b/g/n, 2.4 GHz band only;
Bluetooth 4.2 (only for onboarding)
- Rated Input Voltage: 100-240 VAC, 50/60 Hz
- Max Charging Power Consumption: 18W (DC24V 750mA)
- Max Working Power Consumption:
Robot Vacuum: 45W
- Works with Google Home: Yes
- Works with Amazon Alexa: Yes

[†]Based on internal testing carried out by the manufacturer, using quiet vacuuming mode with a full battery. Actual results may vary according to the working status and home environment.

[‡]Based on internal testing carried out by the manufacturer, using low water flow with a full battery. Actual results may vary according to the home environment.

[§]It is recommended to mop with Tapo Robot Vacuum Foamless Hard-Surface Floor Cleaner.