

DENON[®]

DHT-S217

Dolby Atmos Sound Bar

Owner's Manual



About manuals	4
About descriptions of this manual	4
Accessories	5
Inserting the batteries	6
Operating range of the remote control unit	6
Part names and functions	7
Sound bar	7
Remote control unit	11

Connections

Positioning	13
Positioning the sound bar in front of a TV	13
Hanging the sound bar on a wall	14
Connecting a TV	16
TV equipped with an HDMI connector and compatible with the eARC (Enhanced Audio Return Channel) or ARC (Audio Return Channel)	17
TV equipped with an HDMI connector and incompatible with the eARC or ARC / TV equipped with an optical digital connector	18
TV equipped with an HDMI connector and incompatible with the eARC or ARC / TV equipped with an analog connector	19
Connecting an external subwoofer	20
Connecting a playback device	21
Connecting an HDMI device	21
Connecting the power cords	22

Playback

Playing TV, movies and music	23
Adjusting the volume	24
Adjusting the subwoofer volume	24
Turning off the sound temporarily	24
Playing music on a Bluetooth device	25
Pairing a Bluetooth device for the first time	25
Pairing with other Bluetooth devices	26
Playing music with a paired Bluetooth device	26

Settings

Settings	27
Selecting a sound mode	27
Automatically setting to standby (Auto standby function)	28
Reducing the standby power consumption (Deep standby function)	28
Switching the standby linking via HDMI control function on or off	29
Automatically turning on the power according to the playback of the playback device (Auto on control function)	29
Operating this unit using the remote control of a TV	31



Tips

Troubleshooting	33
Power does not turn on / Power is turned off	34
Operations cannot be performed through the remote control unit	35
Trouble teaching this unit remote control commands	35
No sound comes out	36
Bluetooth playback does not work	37
The HDMI control function does not work	37
Audio can be heard coming from the TV's speakers	37
Resetting factory settings	38

Appendix

About HDMI	39
Trademark information	40
Specifications	41



Thank you for purchasing this Denon product.

To ensure proper operation, please read this owner's manual carefully before using the product.

After reading this manual, be sure to keep it for future reference.



About manuals

The following manuals are included on this unit.

- Safety Instructions (supplied)/Cautions on Using Batteries (supplied) : Describes careful considerations that you should note in order to use this unit correctly and safely. Please read carefully before using this unit.
- Quick Start Guide (supplied) : Describes the basics about how to use this unit. Please read when you use this unit for the first time.
- Owner's Manual (this manual) : Describes details about how to use this unit. Also, describes troubleshooting.

About descriptions of this manual

- DHT-S217 is described as this unit in this manual.
- In this manual, when you can operate either the sound bar or remote control, the operations for remote control are mainly described.
- The symbols used in this manual have the following meanings.









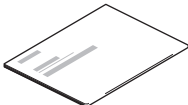

	Information such as the precautions on the use and the function restrictions.
	Information such as supplementary notes that are useful for you to know.

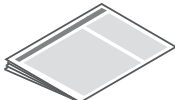
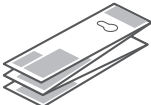
- Contents of this unit may be updated without notice.



Accessories

Check that the following parts are supplied with the product.

 <p>Quick Start Guide</p>	 <p>Safety Instructions</p>	 <p>Cautions on Using Batteries</p>	 <p>Wall mount template</p>	 <p>HDMI cable (4K)</p>
 <p>Power cord (European model only)</p>	<p>or</p>  <p>Power cord (Australian model only)</p>	 <p>Optical digital cable</p>	 <p>Wall mount spacers</p>	 <p>Remote control unit (RC-1251)</p>
 <p>2x R03/AAA batteries</p>				



Inserting the batteries

- 1 Slide the rear cover off the remote control unit in the arrow direction.

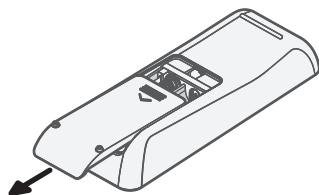

- 2 Insert two batteries correctly into the battery compartment as indicated.

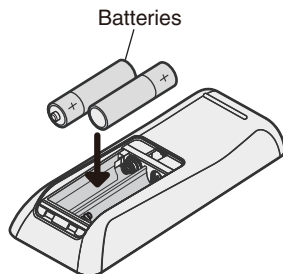

- 3 Put the rear cover back on.

NOTE

- Remove the batteries from the remote control unit if it will not be in use for long periods.
- If the battery fluid should leak, carefully wipe the fluid off the inside of the battery compartment and insert new batteries.

Operating range of the remote control unit

Point the remote control unit at the remote sensor when operating it.

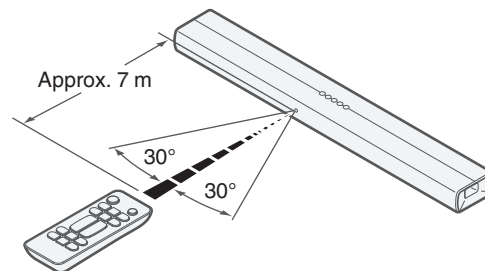

Part names and functions

Sound bar

■ Top panel

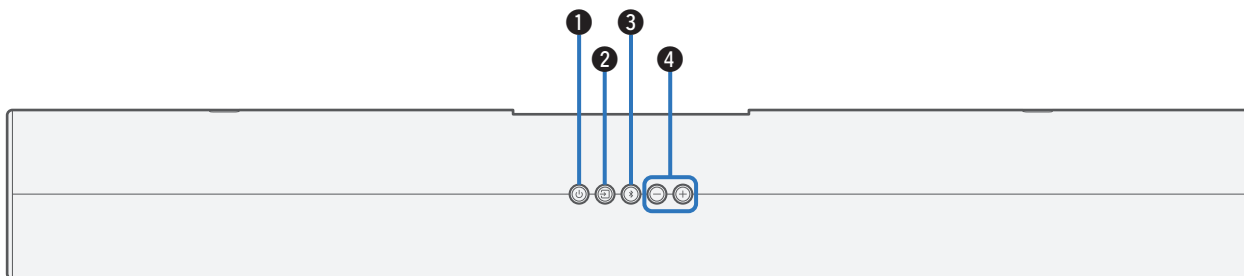

1 Power operation button (⏻)

Turns the sound bar power on/off (standby). (👉 p. 23)

2 Input source button (📺)

This selects the input source. (👉 p. 23)

Switches the input source each time the button is pressed.

3 Bluetooth button (📶)

- Switches the input source to “Bluetooth”. (👉 p. 25)
- Used to pair with Bluetooth devices. (👉 p. 25)

4 Volume buttons (+, -)

These adjust the volume level. (👉 p. 24)



■ Front panel

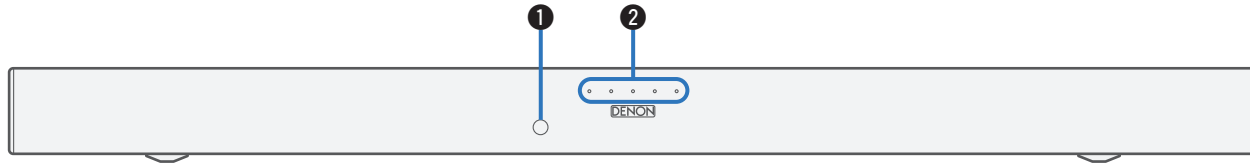

① Remote control sensor

This receives signals from the remote control unit. (👉 p. 6)

② Status LED

The status, such as for the power, input source, audio format, or sound mode is displayed. (👉 p. 9)



■ Status LED

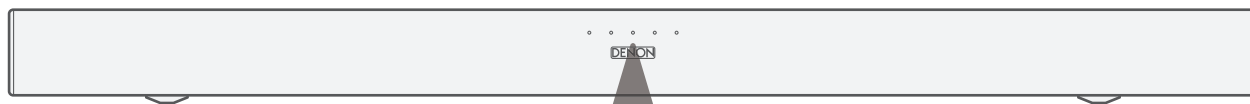

Power	Off (Standby)	<input type="radio"/> <input type="radio"/> <input type="radio"/> <input type="radio"/> <input type="radio"/>	Sound mode [Ex.] Input source: TV (HDMI eARC/ARC)	Movie mode	<input type="radio"/> <input type="radio"/> <input type="radio"/> <input type="radio"/> <input checked="" type="radio"/>	Blink once
	On	<input type="radio"/> <input type="radio"/> <input type="radio"/> <input type="radio"/> <input checked="" type="radio"/>		Music mode	<input type="radio"/> <input type="radio"/> <input type="radio"/> <input type="radio"/> <input checked="" type="radio"/>	Blink twice
Input source	TV (HDMI eARC/ARC)	<input type="radio"/> <input type="radio"/> <input type="radio"/> <input type="radio"/> <input type="radio"/>		Night mode	<input type="radio"/> <input type="radio"/> <input type="radio"/> <input type="radio"/> <input checked="" type="radio"/>	Blink three times
	HDMI	<input type="radio"/> <input checked="" type="radio"/> <input type="radio"/> <input type="radio"/> <input type="radio"/>		Dialog enhancer low	<input type="radio"/> <input type="radio"/> <input type="radio"/> <input type="radio"/> <input checked="" type="radio"/>	Blink once
	TV (OPTICAL)	<input type="radio"/> <input type="radio"/> <input checked="" type="radio"/> <input type="radio"/> <input type="radio"/>		Dialog enhancer medium	<input type="radio"/> <input type="radio"/> <input type="radio"/> <input type="radio"/> <input checked="" type="radio"/>	Blink twice
	AUX	<input type="radio"/> <input type="radio"/> <input type="radio"/> <input checked="" type="radio"/> <input type="radio"/>		Dialog enhancer high	<input type="radio"/> <input type="radio"/> <input type="radio"/> <input type="radio"/> <input checked="" type="radio"/>	Blink three times
Audio format [Ex.] Input source: TV (HDMI eARC/ARC)	Bluetooth	<input type="radio"/> <input type="radio"/> <input type="radio"/> <input checked="" type="radio"/> <input type="radio"/>		Pure mode	<input type="radio"/> <input type="radio"/> <input type="radio"/> <input type="radio"/> <input checked="" type="radio"/>	Blink once
	Dolby Atmos *	<input checked="" type="radio"/> <input type="radio"/> <input type="radio"/> <input type="radio"/> <input type="radio"/>				
	Dolby (other than Atmos)	<input checked="" type="radio"/> <input type="radio"/> <input type="radio"/> <input type="radio"/> <input type="radio"/>				
	PCM (or No Signal)	<input type="radio"/> <input type="radio"/> <input type="radio"/> <input type="radio"/> <input type="radio"/>				
	Unsupported audio format	<input checked="" type="radio"/> <input type="radio"/> <input type="radio"/> <input type="radio"/> <input type="radio"/>				

* When pure mode is set for the sound mode, Dolby Atmos playback is not supported on this unit. If a Dolby Atmos signal is input when in pure mode, the status LED displays the signal input as Dolby (other than Atmos).



■ Rear panel

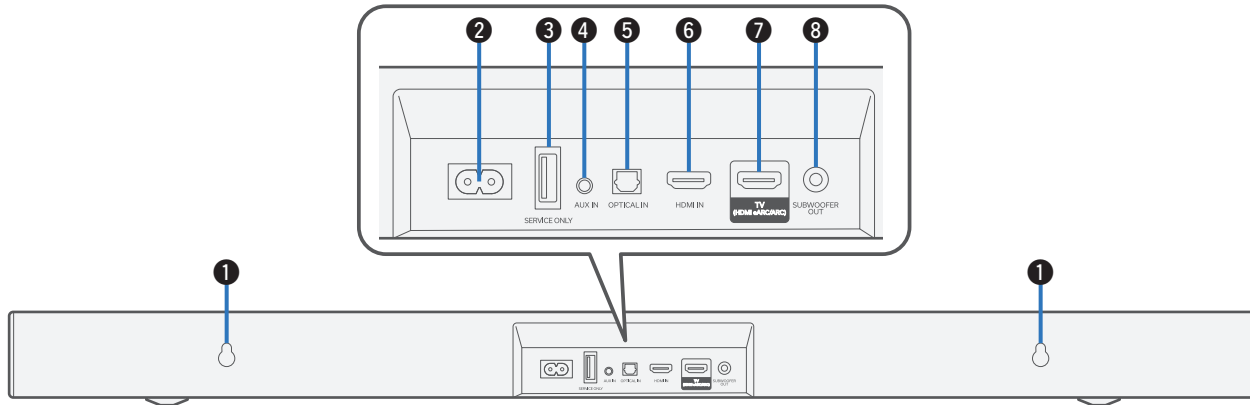

1 Wall hook hole

Used to mount the sound bar on a wall. (👉 p. 14)

2 AC inlet

Used to connect the power cord. (👉 p. 22)

3 USB port

Service terminal. This port does not support playback of music from USB flash drives.

4 Analog audio input connector (AUX IN)

Use a commercially available 3.5 mm stereo audio cable to connect a TV with an AUX audio output connector. (👉 p. 19)

5 Optical digital input connector (OPTICAL IN)

Use the included optical digital cable to connect a TV with an optical digital terminal. (👉 p. 18)

6 HDMI IN connector

Used to connect to the HDMI equipment with an HDMI cable. (👉 p. 21)

7 HDMI connector (TV (HDMI eARC/ARC))

Use the included HDMI cable to connect an eARC or ARC function-compatible TV. (👉 p. 17)

8 Subwoofer output connector (SUBWOOFER OUT)

Use a commercially available subwoofer cable to connect a subwoofer with a built-in amplifier. (👉 p. 20)



Remote control unit

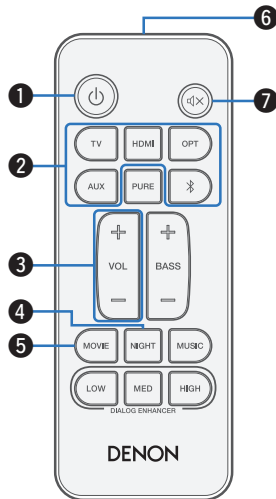

1 Power button (⏻)

Turns the sound bar power on/off (standby). (👉 p. 23)

2 Input source buttons (TV, HDMI, OPT, AUX, *)

This selects the input source. (👉 p. 23)

3 Volume buttons (VOL +, -)

These adjust the volume level. (👉 p. 24)

4 Night mode button (NIGHT)

Compresses the dynamic range (difference between loud and soft sounds) to make audio easier to hear at low volumes. (👉 p. 27)

5 Movie mode button (MOVIE)

Enjoy movie theater-like surround sound. (👉 p. 27)

6 Remote control signal transmitter

This transmits signals from the remote control unit. (👉 p. 6)

7 Mute button (🔇)

This mutes the output audio. Press again to unmute. (👉 p. 24)



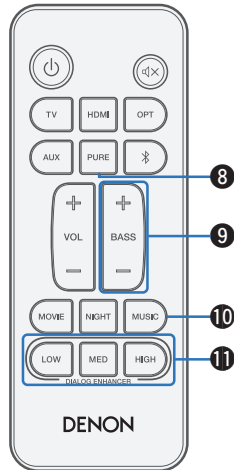

8 Pure mode button (PURE)

Enjoy high quality sound that is faithful to the original source. (👉 p. 27)

9 Button to adjust subwoofer (BASS +, -)

Adjusts the volume level for the subwoofer. (👉 p. 24)

10 Music mode button (MUSIC)

Enjoy the full presence of a wide, encompassing acoustic field. (👉 p. 27)

11 Dialog enhancer buttons (DIALOG ENHANCER LOW, MED, HIGH)

Adjust the volume of dialog in movies, vocals in music, etc. so these can be heard more easily. (👉 p. 27)

Can be set to 3 levels. Set this to the desired value.



Positioning

Positioning the sound bar in front of a TV

Position the sound bar in front of your TV, etc., on a flat surface.

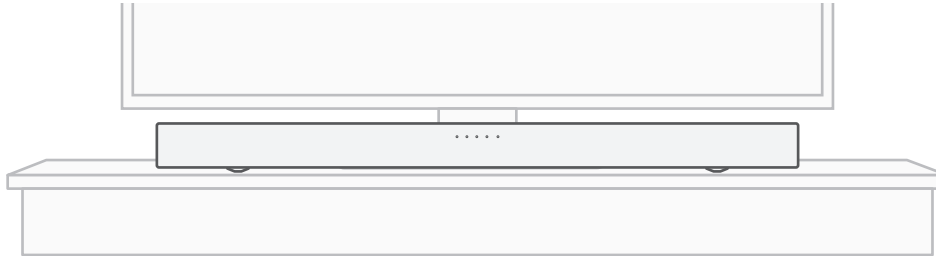

NOTE

- When positioning the sound bar in front of your TV, make sure the sound bar does not obstruct the TV's remote control light sensor, etc.



Hanging the sound bar on a wall

The sound bar can be mounted on a wall using the two keyholes provided on the back of the bar for this purpose. When hanging bar on a wall, position it in a flat, vertical position.

To ensure safety, it is best to employ a contractor to mount the sound bar on the wall.

NOTE

- In order to use the unit safely, do not place items on or hang items from the unit.
- Do not attempt to install the sound bar onto a wall made of material that may crumble easily, such as mortar or decorative plywood. Doing so may result in the screw pulling out and the sound bar falling, causing injury or damage to the sound bar.
- The included HDMI cable have ferrite cores. When hanging the sound bar on a wall, make sure not to put the ferrite core between the sound bar and the wall.
- Be sure to fix connection cables to the wall to ensure that the cables cannot be pulled or tripped over, which may cause the unit to fall. Check that the unit is mounted safely after the mounting work is complete.
- Also, periodically check that the unit is mounted solidly and that there is no possibility that the unit could fall.
- Denon cannot accept any responsibility for damage, injury or accidents caused by problems with the mounting location or mounting method.

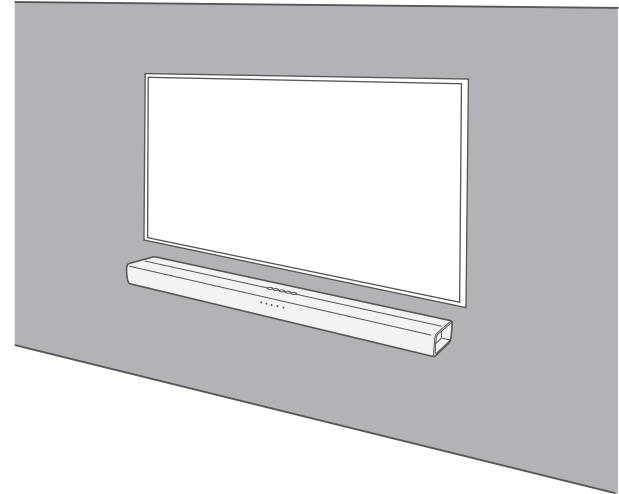



- When hanging the sound bar on a wall, use the included wall mount template.

How to use the wall mount template

- ① Tape the template to the location you would like to mount the sound bar.
- ② Screw in the wall mount screws by following the template.

Screw in one self-tapping screw (commercially available, 5 mm to 6 mm diameter) into a wall that has sufficient strength to support the weight of the sound bar, or into reinforcing material on the wall.

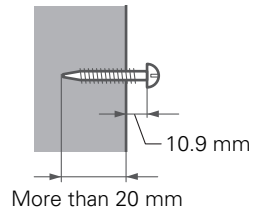

- ③ Remove the template from the wall.
- ④ Mount the included wall mount spacers on the back of the sound bar.
The wall mount spacers create a space for cords to pass through between the sound bar and the wall.
- ⑤ Hang the sound bar on the screws.



Connecting a TV

How to connect a TV depends on the connectors and functions equipped on the TV.



- Enable the TV's HDMI control function when using an HDMI cable to connect this unit to your TV. (See the TV owner's manual for details.)
- Turn off the TV's speaker or minimize the volume when using this unit.
- HDMI cable connection is recommended, but connection can be performed without an HDMI cable.

NOTE

- Make sure all devices are off when connecting.
- Do not plug device power cords into an outlet until all devices have been connected.



TV equipped with an HDMI connector and compatible with the eARC (Enhanced Audio Return Channel) or ARC (Audio Return Channel)

Use the included HDMI cable to connect this unit to an eARC or ARC function-compatible TV.

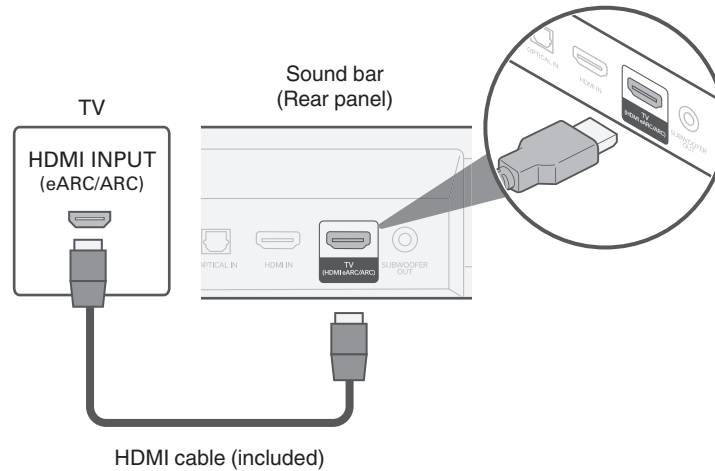

- The TV also needs to be compatible with the eARC or ARC function.



TV equipped with an HDMI connector and incompatible with the eARC or ARC / TV equipped with an optical digital connector

Use the included HDMI and optical cables to connect this unit to your TV.

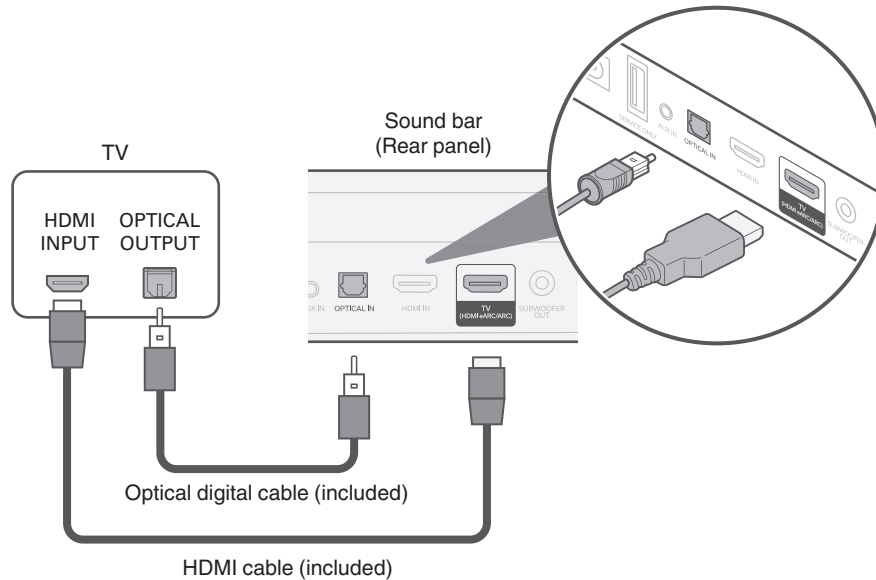

- Line up the optical digital cable with the shape of the terminal to insert.



TV equipped with an HDMI connector and incompatible with the eARC or ARC / TV equipped with an analog connector

Use the included HDMI cable and a commercially available 3.5 mm stereo audio cable to connect this unit to your TV.

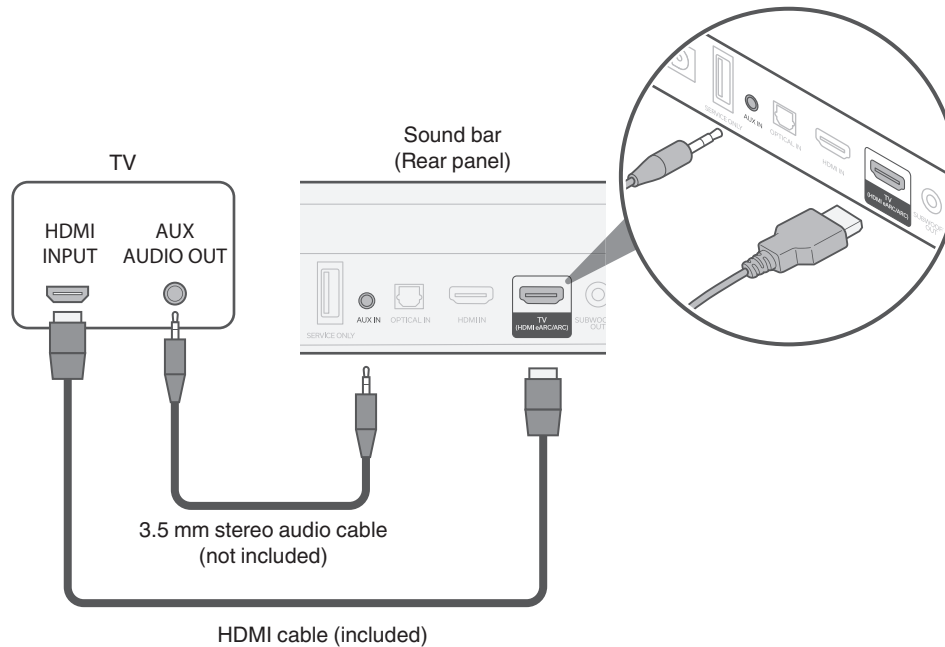

Connecting an external subwoofer

While this device contains a subwoofer of its own, you can achieve even deeper bass by connecting a subwoofer with a built-in amplifier. Use a commercially available subwoofer cable to connect a subwoofer with a built-in amplifier to this unit.

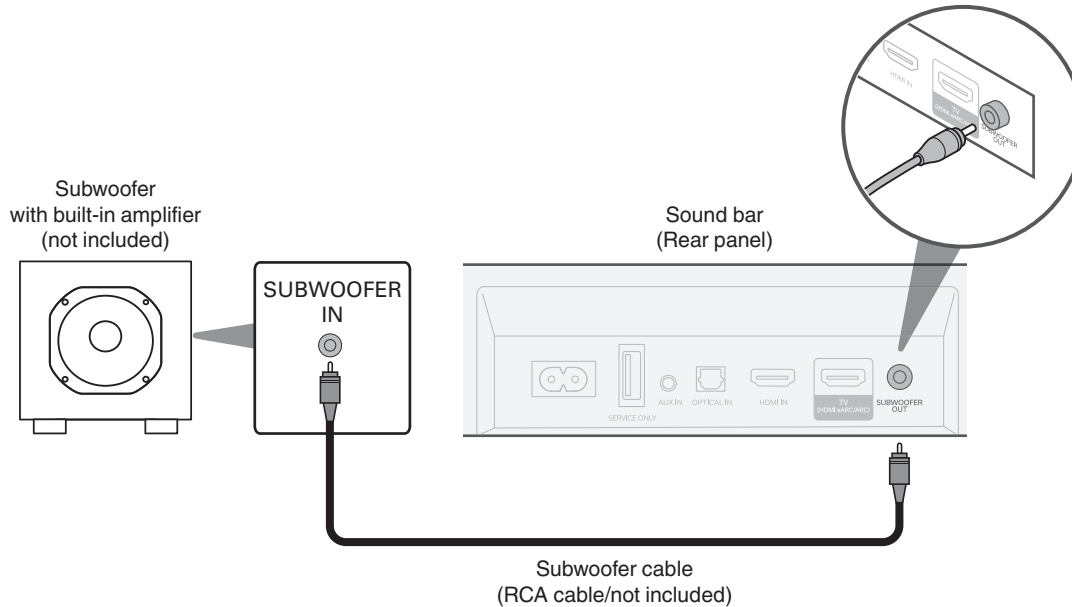

Connecting a playback device

Connecting an HDMI device

Use a commercially available HDMI cable to connect a Blu-ray disc player, game device or similar device to this unit.

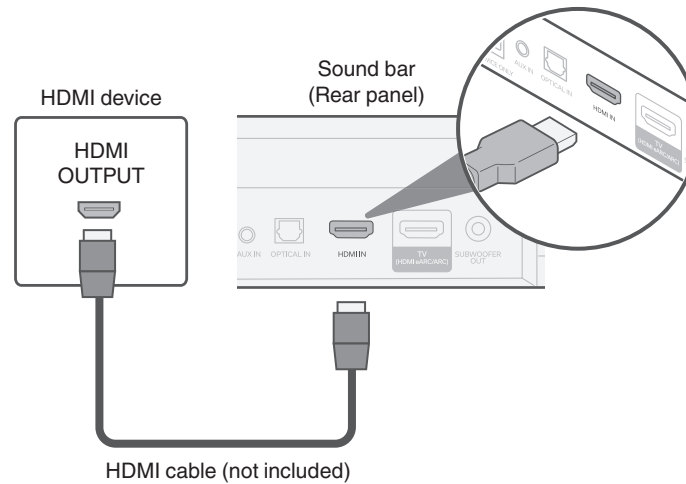

- When connecting this unit to a device that is compatible with the 4K functions, use a “High Speed HDMI cable with Ethernet” that displays the HDMI logo.



Connecting the power cords

After completing all the connections, insert the power plug into the power outlet.

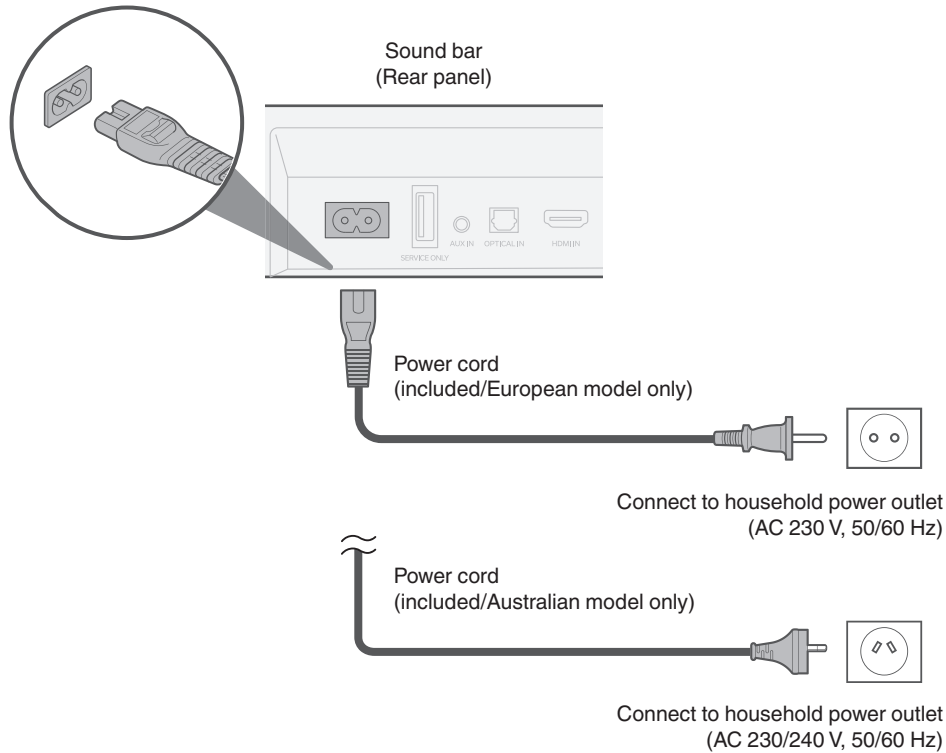

Playing TV, movies and music

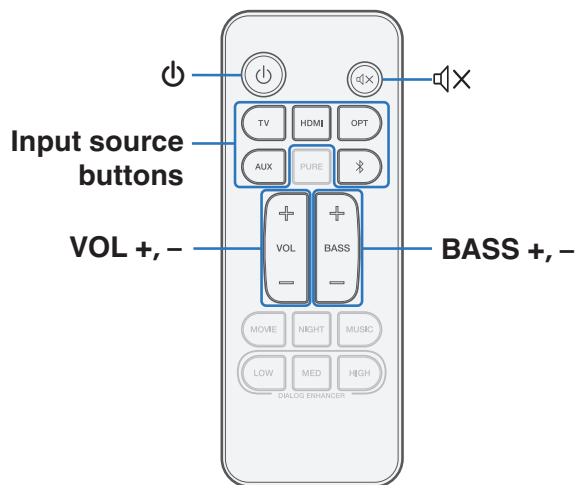

- 1 Turn on the power of the TV and connected devices.
- 2 Press to turn on power to the unit.
- 3 Press the input source button.

TV:	Switches the input source to TV (HDMI eARC/ARC).
HDMI:	Switches the input source to HDMI IN.
OPT:	Switches the input source to OPTICAL IN.
AUX:	Switches the input source to AUX IN.
Ⓜ:	Switches the input source to Bluetooth.

- 4 Play the device connected to this unit.

For details, see the relevant device manual.



- Connect an HDMI control-compatible TV and this unit via HDMI and enable the HDMI control to enable linked control from either device. (🔗 p. 39)



Adjusting the volume

1 Use VOL + or VOL – to adjust the volume.

When the button is pressed, the status LED lights up to match the current volume.

- Each time a volume button is pressed, the status LEDs blink and the number of LEDs that are blinking increases or decreases according to the volume that is set.
- The status LEDs blink three times when the maximum or minimum volume is reached.



- When the power is turned on, the unit starts with the volume level that was set before being placed on standby. However, if the volume was previously set to high, it starts with the volume setting lowered to a certain level.

Adjusting the subwoofer volume

1 Use BASS + or BASS – to adjust the subwoofer volume.

When the button is pressed, the status LED lights up to match the current subwoofer volume.

- The status LED blinks each time the button is pressed, and the number of flashing LEDs increases or decreases to match the subwoofer volume.
- When the subwoofer volume reaches the maximum or minimum, the status LED blinks three times.

Turning off the sound temporarily

1 Press .

All status LEDs blink.



- To cancel, press  again.



Playing music on a Bluetooth device

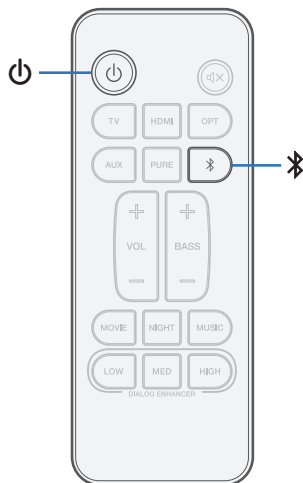

Music files stored on Bluetooth devices such as smartphones, digital music players, etc. can be enjoyed on this unit by pairing and connecting this unit with the Bluetooth device.



Pairing a Bluetooth device for the first time



Pair a Bluetooth device with this unit.

Once the Bluetooth device has been paired, it does not need to be paired again.

- 1 Press  to turn on power to the unit.**
- 2 Press  to switch the input source to “Bluetooth”.**
Automatically switches to pairing mode the first time it is used.
The status LED blinks in blue when this unit is in pairing mode.
- 3 Activate the Bluetooth settings on your Bluetooth device.**
- 4 Select “Denon DHT-S217” from the list of devices displayed on the screen of the Bluetooth device.**
The status LED lights up in blue and this unit and the Bluetooth device are paired.





Pairing with other Bluetooth devices

- 1 Press  to turn on power to the unit.**
- 2 Press  to switch the input source to “Bluetooth”.**
- 3 Activate the Bluetooth settings on your Bluetooth device.**
- 4 Press and hold  for 3 seconds.**

This unit enters pairing mode, and the status LED repeatedly blinks in blue.
- 5 Select “Denon DHT-S217” from the list of devices displayed on the screen of the Bluetooth device.**

The status LED lights up in blue and this unit and the Bluetooth device are paired.

Playing music with a paired Bluetooth device

- 1 Press  to turn on power to the unit.**
- 2 Press  to switch the input source to “Bluetooth”.**
- 3 Activate the Bluetooth settings on your Bluetooth device.**

The status LED lights up in blue and connects to the last Bluetooth device connected. If the connection is cut, perform connection again.
- 4 Play music using any app on your Bluetooth device.**
 -  When this unit is in standby mode, if you try to connect from a paired Bluetooth device, the power of this unit automatically turns on.



Settings

Perform the below operations and settings as needed.

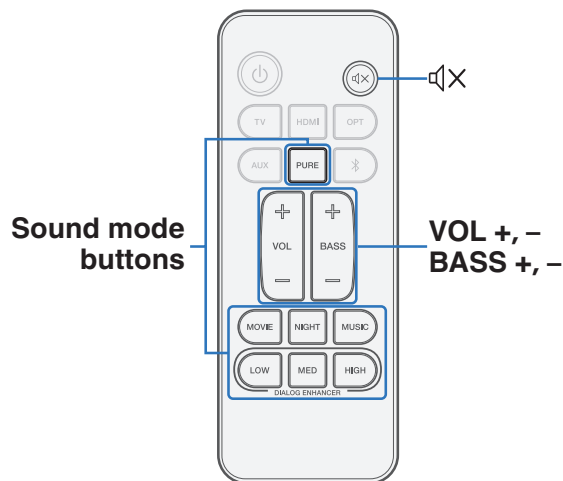

Selecting a sound mode

1 Press the sound mode button to select a sound mode.

When the button is pressed, the rightmost status LED blinks and the sound mode changes. (🔗 p. 9)

MOVIE:	Enjoy movie theater-like surround sound.
NIGHT:	Compresses the dynamic range (difference between loud and soft sounds) to make audio easier to hear at low volumes.
MUSIC:	Enjoy the full presence of a wide, encompassing acoustic field.
DIALOG ENHANCER LOW / MED / HIGH:	Adjust the volume of dialog in movies, vocals in music, etc. so these can be heard more easily. Can be set to 3 levels. Set this to the desired value.
PURE:	Enjoy sound that is faithful to the original source.

NOTE

- In pure mode, Dolby Atmos playback is not supported. If a Dolby Atmos signal is input when in pure mode, the status LED displays the signal input as Dolby (other than Atmos). (🔗 p. 9)



Automatically setting to standby (Auto standby function)

Switch the auto standby function on or off.

When the auto standby function is turned on, the power supply for this unit automatically switches to standby if no operations have been performed for approx. 20 minutes or more and audio is not being output.

1 Press and hold NIGHT for 5 seconds or more.

- The auto standby function switches on or off and the status LED blinks as indicated below.

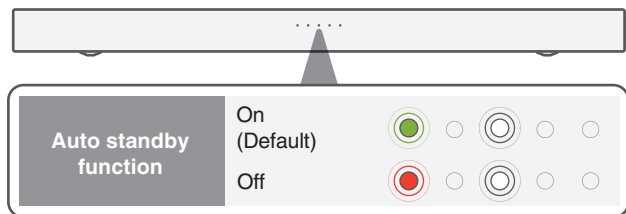

Reducing the standby power consumption (Deep standby function)

This unit can be placed into deep standby mode, in which its standby power consumption is lower than in normal standby mode. Perform the following steps to put this unit into deep standby mode.

1 Press and hold DIALOG ENHANCER HIGH for about 5 seconds or more.

- The deep standby function switches on or off and the status LED blinks as indicated below.

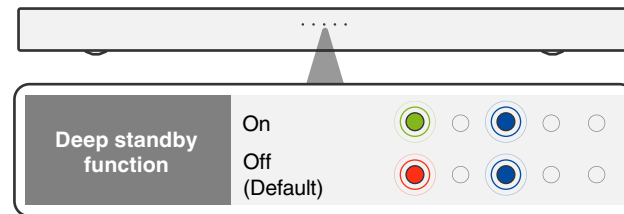

NOTE

- When this unit is in deep standby mode, it cannot be turned on by performing streaming operations with a Bluetooth connection.
- When this unit is in deep standby mode, the auto on control function of the optical and AUX inputs cannot turn on the unit. (☞ p. 29)



Switching the standby linking via HDMI control function on or off

In the default settings, the HDMI control automatically puts the unit into standby mode, linked to the TV's power standby operation. When the standby linking via HDMI control function is turned off, music playback can continue without this unit switching to standby, even if the TV is set to standby while a music player or other device is connected and playing.

1 Press and hold MOVIE for 5 seconds or more.

- The standby linking via HDMI control function switches on or off and the status LED blinks as indicated below.

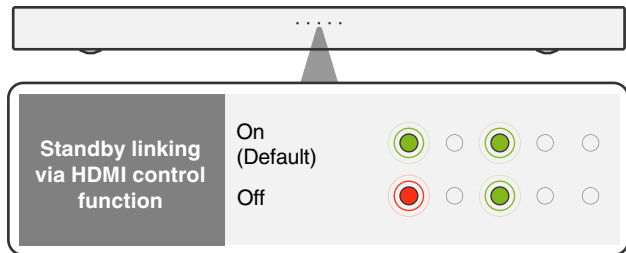

Automatically turning on the power according to the playback of the playback device (Auto on control function)

If you turn on the auto on control function and playback is started by the playback device while this unit is on standby, the power of this unit is automatically turned on and playback is started. In addition, if the power is on, the input source is automatically switched according to the playback of the playback device. The auto on control function can be set to on or off for each input source.

- Switch to the input source you want to set.
- On the remote control unit, press the button that corresponds to the input source you want to set for 5 seconds or longer.

Input source	Button
TV (HDMI eARC/ARC)	TV
OPTICAL IN	OPT
AUX IN	AUX

The status LEDs in the display of the current input source blink three times.

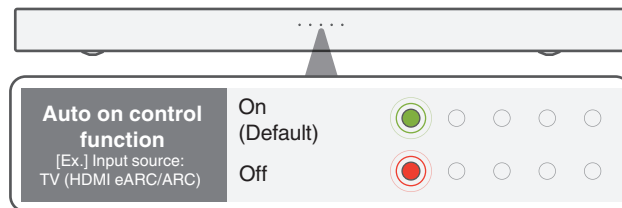



- When the auto on control function is off for the TV (HDMI eARC/ARC) input, the auto on control function for the HDMI IN input also turns off.
- Even if the auto on control function is off for the TV (HDMI eARC/ARC) input, when this unit is powered on and playback is performed with TV or HDMI playback devices, the input source switches automatically to TV (HDMI eARC/ARC) or HDMI IN.
- Even if the auto on control function is on for the optical input or AUX input, the input source will not switch automatically during HDMI (eARC/ARC) playback.
- When this unit is in deep standby mode, the auto on control function of the optical and AUX inputs cannot turn on the unit. (🔍 p. 28)



Operating this unit using the remote control of a TV

There are three ways to operate this unit using the remote control of a TV.

• HDMI control function

Connect this unit to a TV that supports the HDMI control function with an HDMI cable and enable the HDMI control setting on the TV to perform basic operations on this unit (changing the input source, turning the power on and off, adjusting the volume) with the remote control of the TV.

Refer to “HDMI control function” for more information about the HDMI control function. (📖 p. 39)

• Remote control preset function

This unit is preset such that you can adjust the volume using the volume adjustment button on the remote controls for the televisions of major manufacturers. This is useful when the television you are using does not support HDMI control, or when you connect to a television that does not have an HDMI connector.

• Remote control learning function

If your TV does not support the HDMI control function and Remote control preset function, use this unit’s remote control learning function. This enables you to operate this unit with the remote control of a TV. (“Using the remote control learning function” (📖 p. 31))

■ Using the remote control learning function

1 Press and hold the main unit’s for 3 seconds or more.

Among the LEDs on the status display, one white LED light moves back and forth from left to right and indicates that the remote control learning mode has started.

2 Point the remote control of this unit at the remote sensor of this unit and press the remote control button to be learned (e.g. VOL +) once.

All status LEDs blink in white.

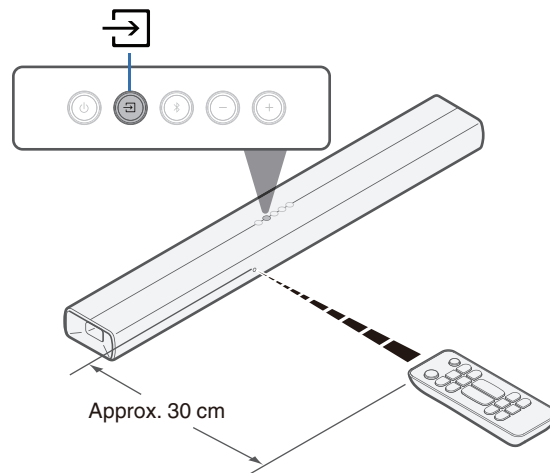

3 Point the remote control of the TV at the remote control sensor of this unit and press the remote control button to be learned (e.g. the button to increase the volume) once.

If learning is successful, the rightmost status LED blinks in green three times.

If learning is unsuccessful, the rightmost status LED blinks in red three times. Repeat steps 2 and 3 if this happens.



- When the status LEDs blink in white again, press the TV remote control button (e.g. the button to increase the volume) once more.

4 To learn a new function, repeat steps 2 and 3 with the next function.

5 Press and hold the main unit's for 3 seconds or more.

The rightmost status LED blinks white three times and indicates that the remote control learning mode is completed.

6 Confirm that the operation (e.g. increasing the volume) can be performed on this unit with the TV remote control.



- To delete all learned data, press and hold  on the sound bar for 10 seconds until all status LEDs blink in purple five times.
- Operations cannot be performed with the remote control learning function during the Deep standby.
- Other operations cannot be performed when in remote control learning mode.
- Remote control learning may not be possible depending on the type of TV remote control.



Troubleshooting

If a problem should arise, first check the following:

1. **Are the connections correct?**
2. **Is the set being operated as described in the owner's manual?**
3. **Are the other devices operating properly?**

If this unit does not operate properly, check the corresponding symptoms in this section.

If the symptoms do not match any of those described here, consult your dealer as it could be due to a fault in this unit. In this case, disconnect the power immediately and contact the store where you purchased this unit.



Power does not turn on / Power is turned off

Power does not turn on.

- Check whether the power plug is correctly inserted into the power outlet. (👉 p. 22)
- If the power of this unit cannot be turned on with the remote control for the TV, press the ⏻ button to turn on the power of this unit. (👉 p. 39)
- Enable the TV's HDMI control function when using an HDMI cable to connect this unit to your HDMI control-compatible TV. (See the TV owner's manual for details.)
- If the power cannot be turned on through a Bluetooth connection, this is in the deep standby mode. Press the ⏻ to turn on power to the unit. (👉 p. 28)
- If you set the auto on control function to off, the power of this unit will not automatically turn on even if playback is started by the TV or the playback device. (👉 p. 29)
- If the power cannot be turned on using the auto on control function of the optical and AUX inputs, this is in the deep standby mode. Press the ⏻ to turn on power to the unit. (👉 p. 29)

Power automatically turns off.

- If no operations have been performed for 20 minutes or more and audio is not being input, this unit automatically switches to standby. Turn this unit's power on again. To prevent the power from turning off automatically, turn off the auto standby function. (👉 p. 28)

Even if the power of the TV is turned off, the power of this unit is not automatically turned off.

- If the standby linking via HDMI control function is turned off, this unit will not switch to standby even if the power of the TV that is connected via HDMI is turned off. (👉 p. 29)
- If the input source is Bluetooth, this unit will not switch to standby even if the power of the TV that is connected via HDMI is turned off.

Power turns off and the the left most status LED flashes in red.

- The protection circuit has been activated due to a rise in temperature within sound bar. Unplug the power cord, wait about an hour until this unit cools down sufficiently, and then turn the power on again.
- Turn on the power again and turn down the volume.



Operations cannot be performed through the remote control unit

Operations cannot be performed through the remote control unit.

- Batteries are worn out. Replace with new batteries. (👉 p. 6)
- Operate the remote control unit within a distance of about 7 m from this unit and at an angle of within 30°. (👉 p. 6)
- Remove any obstacle between this unit and the remote control unit.
- Insert the batteries in the proper direction, checking the ⊕ and ⊖ marks. (👉 p. 6)
- This unit's remote control sensor is exposed to strong light (direct sunlight, inverter type fluorescent bulb light, etc.). Move this unit to a place in which the remote control sensor will not be exposed to strong light.

Trouble teaching this unit remote control commands

Trouble teaching this unit remote control commands.

- Remember that while this unit can learn almost all IR (infrared) remote commands, there remain a few rare code formats that cannot be taught.



No sound comes out

No sound comes out.

- Check the connections for all devices. (👉 p. 16)
- Insert connection cables all the way in.
- Check that input connectors and output connectors are not reversely connected.
- Check cables for damage.
- Check that a proper input source is selected. (👉 p. 23)
- Adjust the volume. (👉 p. 24)
- Make sure volume is not muted. (👉 p. 24)
- If the status LED lights up in red, an audio signal that is not supported by this unit is input. (👉 p. 9)
In that case, set the audio format to “PCM” on the audio output device.



Bluetooth playback does not work

Cannot pair with a Bluetooth device.

- It may be that Bluetooth is not enabled on the Bluetooth device. See the owner's manual of the Bluetooth device to enable the Bluetooth function.
- This unit may be paired with another Bluetooth device. Select this unit from the list of devices displayed on the screen of the Bluetooth device.
- Bring the Bluetooth device near to this unit.
- Turn the power of the Bluetooth device off and on again, and then try again.
- Only 1 Bluetooth device can be connected at a time.
- The connection from the Bluetooth mobile device is malfunctioning. Power cycle the mobile device, remove the pairing information and re-pair this unit to the mobile device.

The sound is cut off.

- Bring the Bluetooth device near to this unit.
- Remove obstructions between the Bluetooth device and this unit.
- To prevent electromagnetic interference, locate this unit away from microwave ovens, wireless LAN devices and other Bluetooth devices.
- Pair with the Bluetooth device again. (📖 p. 25)

The HDMI control function does not work

The HDMI control function does not work.

- You cannot operate devices that are not compatible with the HDMI control function. In addition, depending on the connected device or the settings, the HDMI control function may not work. In this case, operate the external device directly.
- Check that the HDMI control function setting is enabled on all devices connected to this unit.

Audio can be heard coming from the TV's speakers

Audio can be heard coming from the TV's speakers.





- Disable the TV's speakers (usually a setup-menu option, but a rear-panel switch on some TVs).

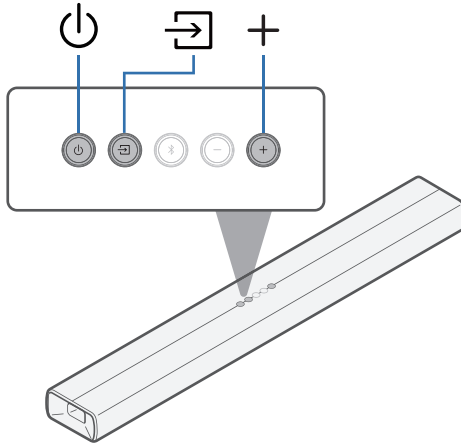

Resetting factory settings

Perform this procedure if the display is abnormal or if operations cannot be performed. Various settings are reset to the factory default values. Make settings again.



- 1 Press  to turn on power to the unit.**
- 2 Press and hold the main unit's ,  and + at the same time for at least 5 seconds.**
The status LED blinks in red three times.
- 3 Wait for around 10 seconds after the LED turns off and then press .**
All settings return to the factory settings after the sound bar is restarted.



About HDMI

This unit supports the following HDMI functions.

- **ARC (Audio Return Channel) function**

Enjoy movies, music, etc., on your TV simply by connecting an ARC function-compatible TV to this unit via HDMI.

- **eARC (Enhanced Audio Return Channel) function**

The eARC function is compatible with conventional ARC function compatible audio formats in addition to multichannel linear PCM, Dolby TrueHD, Dolby Atmos and other audio formats a conventional ARC function cannot transmit. Additionally, connecting to an eARC function-compatible TV enables enjoyment of higher-quality surround playback of the audio content played from your TV.

- **HDMI control function**

Connect an HDMI control-compatible TV and this unit via HDMI and enable the HDMI control to enable linked control from either device.

- Input source switching

If the TV is turned on, this unit automatically powers on and switches the input source.

- Power off link

The TV power off operation is linked so this unit also turns off.

- Volume adjustment

The volume of this unit can be adjusted using the TV remote control.

- Audio output destination switching

If this unit is turned on, TV audio is output from this unit. If this unit is turned off, TV audio is output from the speakers of the TV.

NOTE

- Some functions may not operate depending on the connected TV.



Trademark information



The Bluetooth® word mark and logos are registered trademarks owned by the Bluetooth SIG, Inc. and any use of such marks by D&M Holdings Inc. is under license. Other trademarks and trade names are those of their respective owners.



Dolby, Dolby Vision, Dolby Atmos, and the double-D symbol are registered trademarks of Dolby Laboratories Licensing Corporation. Manufactured under license from Dolby Laboratories. Confidential unpublished works. Copyright © 2012-2021 Dolby Laboratories. All rights reserved.



The terms HDMI and HDMI High-Definition Multimedia Interface, and the HDMI Logo are trademarks or registered trademarks of HDMI Licensing, LLC in the United States and other countries.



Specifications

■ General

Operating temperature:	5 °C - 35 °C
Power supply:	AC 100 - 240 V, 50/60 Hz
Power consumption:	40 W
Power consumption in standby mode:	1.7 W
Power consumption in deep standby mode:	0.5 W
Max Analog Input:	2 Vrms
Sampling frequency:	32 kHz, 44.1 kHz, 48 kHz
Supported audio formats:	Linear PCM, Dolby Digital, Dolby Digital Plus, Dolby TrueHD, Dolby Atmos

■ Bluetooth section

Communications system:	Bluetooth Version 5.0
Transmission power:	Power Class 2
Maximum communication range:	Approx. 10 m in line of sight*
Used frequency range:	2.4 GHz band
Modulation scheme:	FHSS (Frequency-Hopping Spread Spectrum)
Supported profiles:	A2DP (Advanced Audio Distribution Profile) 1.3 AVRCP (Audio Video Remote Control Profile) 1.6
Corresponding codec:	SBC
Transmission range (A2DP):	20 Hz – 20,000 Hz

* The actual communication range varies depending on the influence of such factors as obstructions between devices, electromagnetic waves from microwave ovens, static electricity, cordless phones, reception sensitivity, antenna performance, operating system, application software etc.



■ Dimensions (Unit: mm)

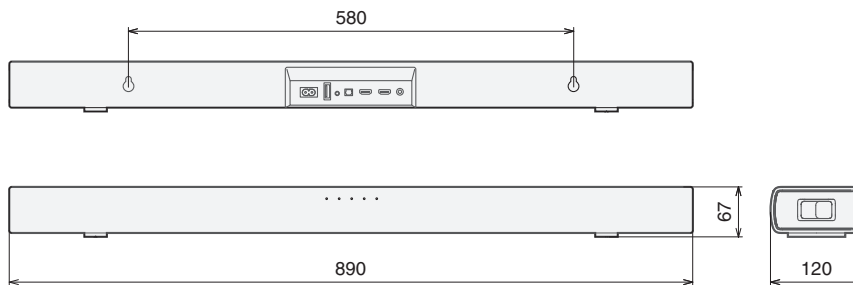

■ Weight: 3.6 kg



DENON[®]

www.denon.com

3520 10856 00AD

© 2022 Sound United. All Rights Reserved.