



Digital Projector

User Manual

Portable Series | GV11

V 1.01

Product support

You are strongly recommended to upgrade the product to the latest firmware version and refer to the most up-to-date user manual to make best use of the product. To upgrade the firmware, see [Upgrading your projector on page 42](#).

This document aims to provide the most updated and accurate information to customers, and thus all contents may be modified from time to time without prior notice. Please visit the website for the latest version of this document and other product information. Available files vary by model.

1. Make sure your computer is connected to the Internet.
2. Visit the local website from [Support.BenQ.com](#). The website layout and content may vary by region/country. Look for the following regularly to get the most up-to-date information.
 - User manual and related document
 - Firmware and applications
 - Frequently asked questions

Servicing

- If misuse or other accident occurs, contact qualified service personnel for servicing.
- Contact your place of purchase or visit the local website from [Support.BenQ.com](#) for more support.



Support.BenQ.com

Q&A Index

Start with the topics you are interested in:

Setup

How do I set up the projector and turn it on?

| | |
|---------------------|----|
| Choosing a location | 27 |
| Operations | 32 |

Image adjustment

How do I adjust the focus of the projected image?

| | |
|--------------------------------|----|
| Adjusting the projection angle | 40 |
| Fine-tuning the image clarity | 41 |
| Correcting keystone | 42 |

How do I adjust the projector for outdoor use?

| | |
|---|----|
| Using the projector in an outdoor setting | 31 |
| Outdoor use | 67 |

Usage

How to project wirelessly?

| | |
|---------------------|----|
| Wireless projection | 52 |
|---------------------|----|

How do I play music via the projector?

| | |
|---|----|
| Using the built-in speaker on the projector | 47 |
| Using the projector as a Bluetooth speaker | 55 |

How do I use voice control?

| | |
|------------------|----|
| Google Assistant | 46 |
|------------------|----|

How to watch more streaming videos?

| | |
|---------------------------------|----|
| Accessing more streaming videos | 47 |
|---------------------------------|----|

Maintenance and Product Support

What should I do if I don't plan to use the projector for a long time?

Storing the projector

66

How do I clean my projector after outdoor use?

Outdoor use

67

Important safety instructions

9

Table of contents

| | |
|---|----|
| Product support | 2 |
| Servicing..... | 2 |
| Q&A Index | 3 |
| Package contents | 12 |
| Standard accessories..... | 12 |
| Introduction | 14 |
| Projector exterior view - front, top and left side view | 14 |
| Projector exterior view - rear, bottom, and right side view | 15 |
| Dimensions | 16 |
| Ports | 17 |
| LED indicators | 18 |
| Remote control..... | 21 |
| Installing/Replacing the remote control batteries | 23 |
| Remote control effective range..... | 24 |
| BenQ Smart Control (remote control app) | 25 |
| Installation | 27 |
| Choosing a location | 27 |
| Moving the projector | 29 |
| Obtaining a preferred projected image size | 30 |
| Projection dimensions | 30 |

| | |
|---|----|
| Using the projector in an outdoor setting..... | 31 |
| Operations | 32 |
| Installing the ATV dongle..... | 32 |
| Assembling the adapter | 34 |
| Charging the battery | 35 |
| Starting up the projector | 35 |
| Shutting down the projector | 39 |
| Setting the projector to power saving mode..... | 39 |
| Adjusting the projected image | 40 |
| Adjusting the projection angle | 40 |
| Fine-tuning the image clarity..... | 41 |
| Correcting keystone..... | 42 |
| Upgrading your projector | 42 |
| Android TV | 44 |
| The Android TV home screen..... | 44 |
| Google Assistant | 46 |
| Playing music via the projector | 47 |
| Using the built-in speaker on the projector | 47 |
| Using the projector as a Bluetooth speaker | 47 |
| Accessing more streaming videos | 47 |
| Connections | 49 |
| Switching between Android TV and input sources | 51 |

| | |
|--|----|
| Wireless connections | 52 |
| Wireless projection..... | 52 |
| Wired connections..... | 53 |
| Connecting a device with HDMI..... | 53 |
| Connecting a USB flash drive..... | 54 |
| Bluetooth connections | 55 |
| Using the projector as a Bluetooth speaker | 55 |
| Pairing/Connecting to a Bluetooth speaker or headphones..... | 56 |
| Navigating the settings menu | 59 |
| About the settings menu | 59 |
| Using the Settings menu..... | 60 |
| Brightness | 61 |
| Picture Mode | 61 |
| Sound Mode | 61 |
| Picture | 62 |
| Installation | 62 |
| Sound | 63 |
| Power Mode | 64 |
| System | 64 |
| Maintenance | 66 |
| Care of the projector | 66 |
| Cleaning the lens..... | 66 |
| Storing the projector | 66 |
| Transporting the projector | 67 |
| Outdoor use | 67 |
| Extending LED life | 67 |
| Troubleshooting | 69 |

| | |
|--|----|
| Specifications | 72 |
| Projector specifications | 72 |
| Timing chart..... | 75 |
| Supported file formats | 78 |
| Appendix | 79 |
| Installing the projector on a tripod (purchased separately)..... | 79 |
| Copyright and disclaimer | 80 |
| Copyright | 80 |
| Disclaimer | 80 |
| Warranty..... | 80 |
| Statement regarding hyperlinks and third-party websites | 81 |

Important safety instructions

Your projector is designed and tested to meet the latest standards for safety of information technology equipment. However, to ensure safe use of this product, it is important that you follow the instructions mentioned in this manual and marked on the product.

1. Please read this user manual before you operate your projector.
Keep this manual in a safe place for future reference.

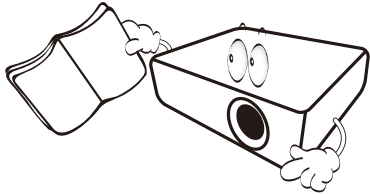

2. Always place the projector on a level, horizontal surface during operation.
 - Do not place the projector on an unstable cart, stand, or table as it may fall and be damaged.
 - Do not place inflammables near the projector.
 - Do not use if tilted at an angle of more than 10 degrees left to right, nor at angle of more than 15 degrees front to back.

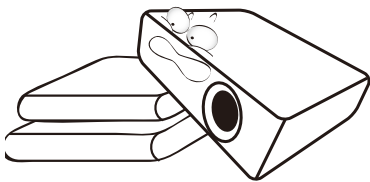

3. Do not store the projector on end vertically. Doing so may cause the projector to fall over, causing injury or resulting in damage.

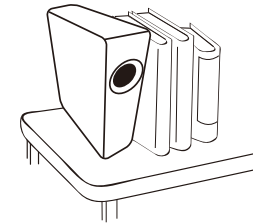

4. Do not place the projector in any of the following environments:
 - Space that is poorly ventilated or confined. Allow at least 50 cm clearance from walls and free flow of air around the projector.
 - Locations where temperatures may become excessively high, such as the inside of a car with all windows closed.
 - Locations where excessive humidity, dust, or cigarette smoke may contaminate optical components, shorten the projector's lifespan and darken the screen.

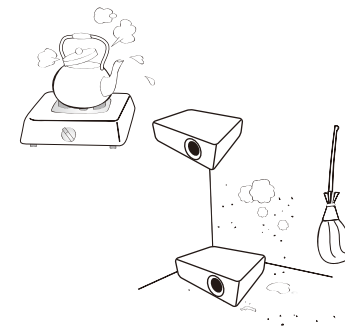

- Locations near fire alarms.
- Locations with an ambient temperature above 40°C/104°F.

- Locations where the altitudes are higher than 2000 m (6562 feet).

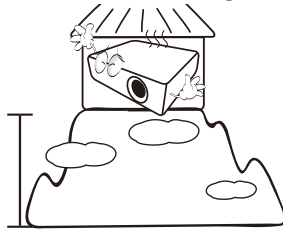

5. Do not block the vents holes while the projector is on (even in power-saving mode).
 - Do not cover the projector with any item.
 - Do not place the projector on a blanket, bedding or any other soft surface.

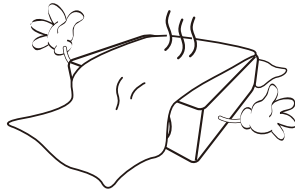

6. In areas where the mains power supply voltage may fluctuate by ± 10 volts, it is recommended that you connect the projector through a power stabilizer, surge protector or uninterruptible power supply (UPS) as appropriate to your situation.

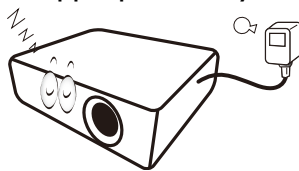

7. Do not step on the projector or place any objects upon it.

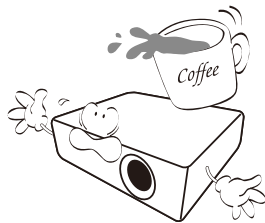

8. Do not place liquids near or on the projector. Liquids spilled into the projector will void your warranty. If the projector does become wet, disconnect it from the power point and call BenQ to have the projector repaired.

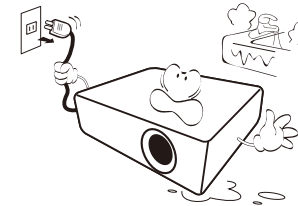

9. Do not look straight into the projector lens during operation. It may harm your sight.

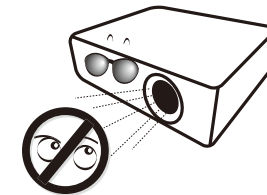

10. Do not operate the projector LED beyond the rated LED life. Excessive operation of LEDs beyond the rated life could cause LEDs to break on rare occasions.

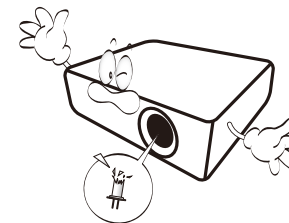

11. Do not attempt to disassemble this projector. There are dangerous high voltages inside which may cause death if you should come into contact with live parts.

Under no circumstances should you ever undo or remove any other covers. Refer servicing only to suitably qualified professional service personnel.

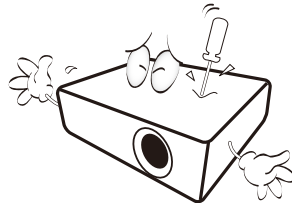

! Please keep the original packing for possible future shipment. If you need to pack your projector after use, adjust the projection lens to an appropriate position, put the lens cushion around the lens, and fit the lens cushion and projector cushion together to prevent damage during transportation.

12. When you think service or repair is required, take the projector only to a suitably qualified technician.

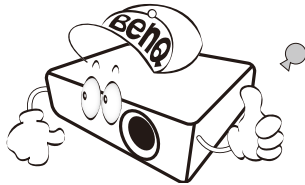

Moisture condensation

Never operate the projector immediately after moving it from a cold location to a hot location. When the projector is exposed to such a change in temperature, moisture may condense on the crucial internal parts. To prevent the projector from possible damage, do not use the projector for at least 2 hours when there is a sudden change in temperature.

Avoid volatile liquids

Do not use volatile liquids, such as insecticide or certain types of cleaner, near the projector. Do not have rubber or plastic products touching the projector for a long time. They will leave marks on the finish. If cleaning with a chemically treated cloth, be sure to follow the cleaning product's safety instructions.

Disposal

This product contains the following materials which are harmful to human bodies and environment.

- Lead, which is contained in solder.

To dispose of the product, consult your local environment authorities for regulations.

! The illustrations and the images shown in this document are for your reference. The actual content may vary by the product supplied for your region.

Package contents

Carefully unpack and verify that you have the items below. Some of the items may not be available depending on your region of purchase. Please check with your place of purchase.

Standard accessories

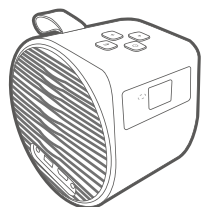

GV11 Projector



QS01 HDMI Media Streaming (ATV dongle)¹

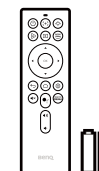

Remote Control (with Two AAA Batteries)²

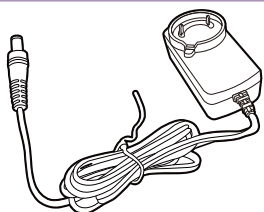

Adapter



Plugs (Supplied items may differ by region)

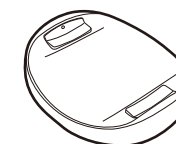

Projector Base



Carrying Bag



Quick Start Guide



Warranty Card
(varies by region)

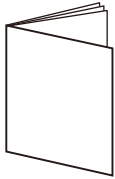

Regulatory Statement



ATV Dongle Installation Guide

-
- ¹: The supplied QS01 HDMI Media Streaming is an ATV dongle to be used with the projector.
 - ²: Availability may vary. Purchase separately if batteries are not included in the package.
 - LED life results will vary depending on environmental conditions and usage. Actual product's features and specifications are subject to change without notice.
 - LED replacement is not user-serviceable. When it is needed, please contact the service center.
 - Some of the accessories may vary from region to region.
 - The warranty card is only supplied in some specific regions. Please consult your dealer for detailed information.
 - For AC/DC adapter, the socket-outlet shall be installed near the equipment and shall be easily accessible.
 - Use original accessories to ensure compatibility.
 - Adapter plug type may change based on regional requirements.
-

Introduction

Projector exterior view - front, top and left side view

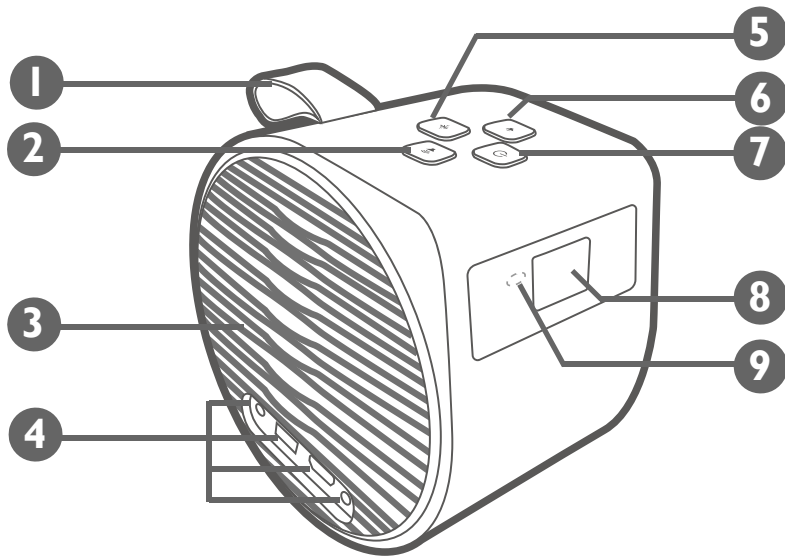

1. Strap



The strap can hold the weight of the product so you can carry the product easily. Excessive force is prohibited though. Do not drag the strap with force or shake the product.

2. Volume up button

3. Vent

4. IO ports

See [Ports on page 17](#) for details. See [Connections on page 49](#) for connections.

5. Bluetooth button and LED

Activates Bluetooth speaker mode. See [Using the projector as a Bluetooth speaker on page 55](#) for more details. See [LED indicators on page 18](#) for LED behaviors.

6. Volume down button

7. Power button and LED

- When the projector is powered off, press and hold for 2 seconds to turn the projector on. See [Starting up the projector on page 35](#) for more details. See [LED indicators on page 18](#) for details on the LED behavior.
- When the projector is powered on, press and hold for 2 seconds to power off.
- When the projector is powered on, short press to bring up the power menu. See [Setting the projector to power saving mode on page 39](#) for information on **Power Saving** and [Using the built-in speaker on the projector on page 47](#) for information on **Audio-Only Mode**.

8. Projection lens

9. IR sensor

Projector exterior view - rear, bottom, and right side view

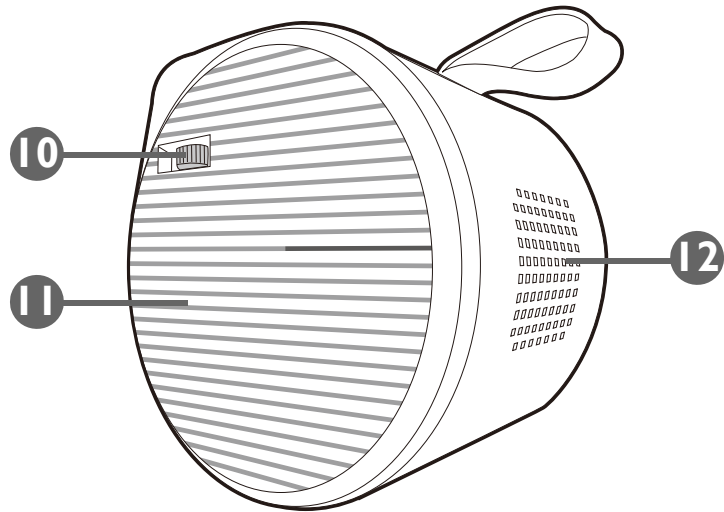

10. Focus knob

11. Right cover

Once removed, you can install the ATV dongle (QS01). See [Installing the ATV dongle on page 32](#) for more details about removing the right cover.

12. Speaker

13. Tripod screwhole

Used to attached a tripod plate to mount the projector on a tripod. See [Installing the projector on a tripod \(purchased separately\) on page 79](#) for details.

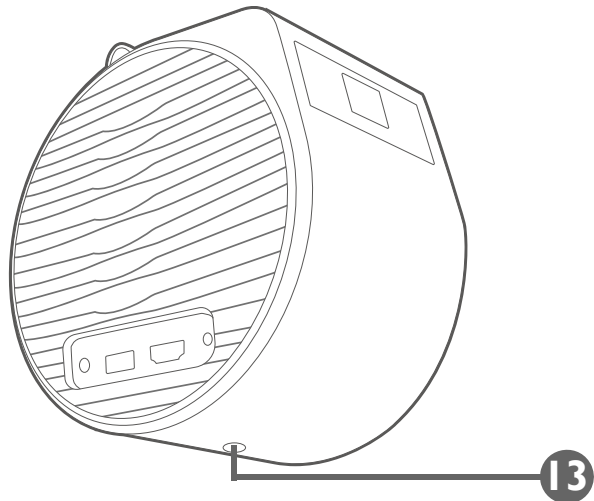

Dimensions

104.7 (W) x 140 (H) x 140 (D) mm (4.1 x 5.5 x 5.5 in) (without base)

113.5 (W) x 153.3 (H) x 140 (D) mm (4.5 x 6.0 x 5.5 in) (with base)

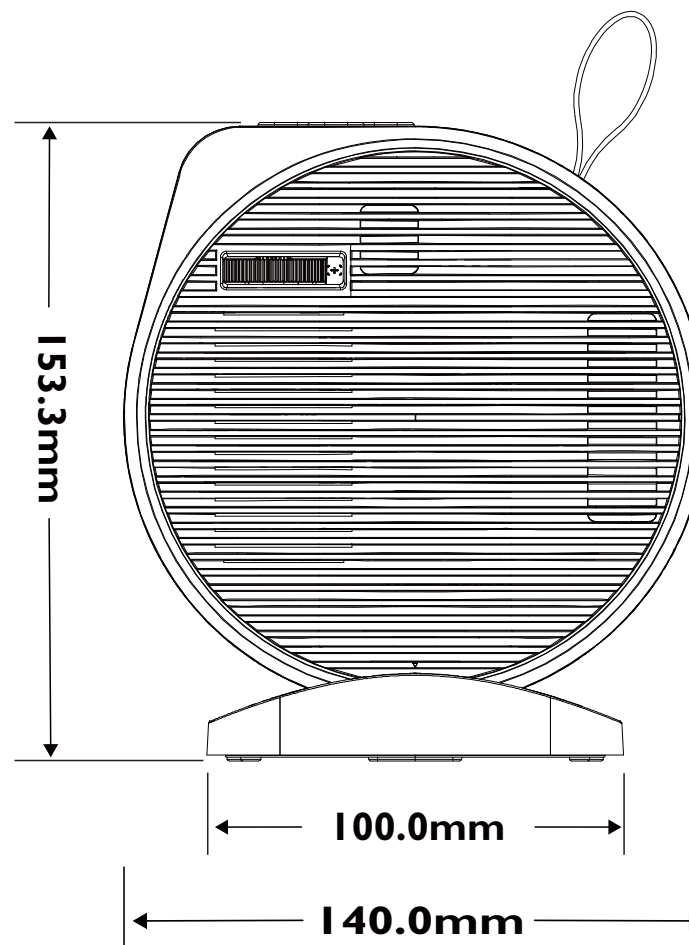
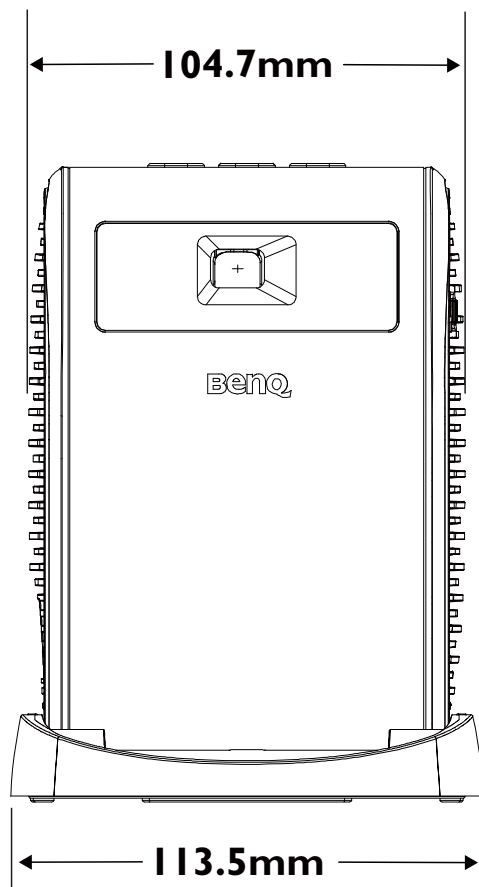

Ports

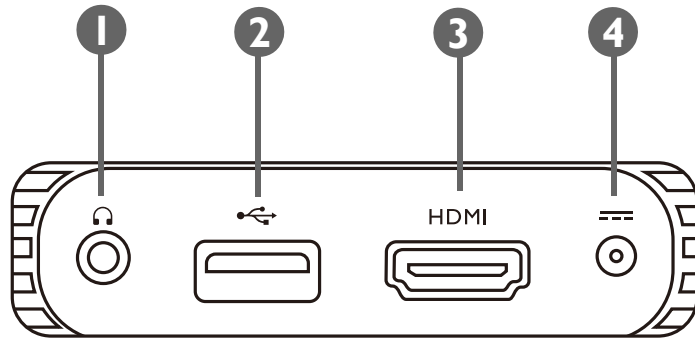

1. 3.5" audio output jack

Used to connect headphones, speakers, and other equipment to play audio.

2. USB-A port

- Used to connect a USB flash drive to project/broadcast media stored on the device.
- Used for firmware update.

3. HDMI port

Used to connect video sources that support the HDMI interface.

4. Power adapter port



Please only use the supplied power adapter to avoid possible dangers such as electric shock and fire.

LED indicators

There is a multi-color power LED and a blue/red Bluetooth LED at the top of the projector.

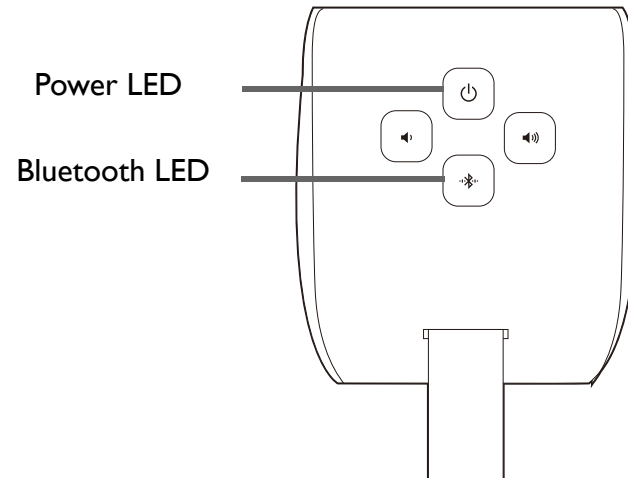

Refer to the table below for definitions of various LED behaviors.

| Scenario | Status | Power LED indicator | Bluetooth LED indicator |
|--------------------------|------------------------------|--|-------------------------|
| | | LED Behavior | LED Behavior |
| Turning on / Turning off | Powering on / off properly | Green - slow flashing | N/A |
| | Low battery capacity (< 5%) | Red - flashing until the power button on the device is no longer pressed | N/A |
| Charging with adapter | Battery capacity = 0 - 98% | Red - solid | N/A |
| | Battery capacity = 99 - 100% | Green - solid | N/A |

| Scenario | | Status | Power LED indicator | Bluetooth LED indicator |
|------------------------|---------------------------------|--|---|----------------------------------|
| | | | LED Behavior | LED Behavior |
| Battery Mode | Power on | Battery capacity = 60 - 100% | Green - solid | N/A |
| | | Battery capacity = 13 - 59% | Orange - solid | N/A |
| | | Battery capacity \leq 12% | Red - slow flashing | N/A |
| | Power saving or Audio-only mode | Battery capacity = 60 - 100% | Green - breathing | N/A |
| | | Battery capacity = 13 - 59% | Orange - breathing | N/A |
| | | Battery capacity \leq 12% | Red - breathing | N/A |
| Bluetooth Speaker Mode | | Switching to Bluetooth speaker mode | Refer to charging or battery mode behavior. | Blue - flashing |
| | | Waiting for pairing and connecting | Refer to charging or battery mode behavior. | Blue - flashing |
| | | Connected successfully | Refer to charging or battery mode behavior. | Blue - flashing twice then solid |
| | | Playing music | Refer to charging or battery mode behavior. | Blue - solid |
| | | Disconnecting and entering into Bluetooth standby mode | Refer to charging or battery mode behavior. | Blue - solid then flashing |
| | | Switching to Projector mode | Refer to charging or battery mode behavior. | Blue - flashing then off |

| Scenario | Status | Power LED indicator | Bluetooth LED indicator |
|----------|----------------------------------|---------------------|-------------------------|
| | | LED Behavior | LED Behavior |
| Error* | Driver board error | Purple - solid | Red- flashing |
| | Fan error | Red - solid | Red - flashing |
| | Optical engine temperature error | Red - flashing | Red - solid |
| | Battery error | Purple - flashing | Red - solid |
| | G sensor error | N/A | N/A |



*: Restart the projector if there are any errors.

Remote control

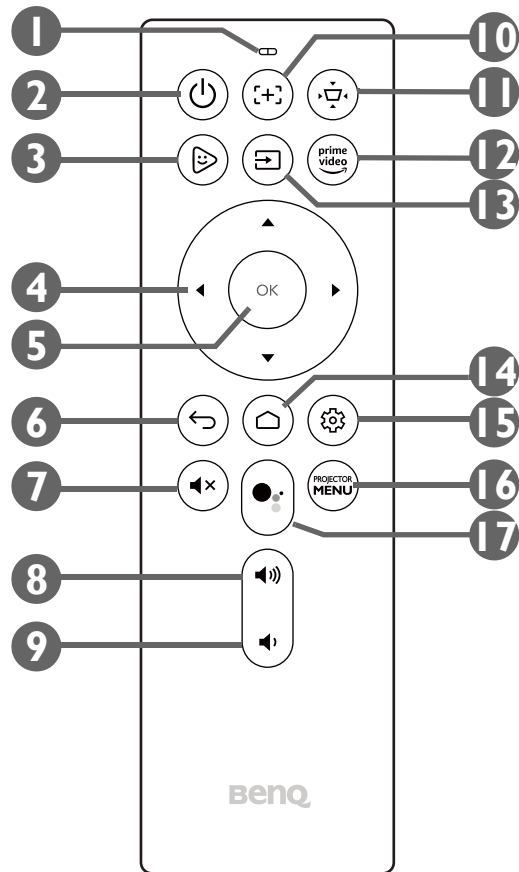

1. Microphone

Receives spoken commands for Google Assistant.

2. Power

Powering on via the remote control is not enabled by default. To enable it, go to **System > Use remote control to power on**. See [Starting up the projector on page 35](#) for more details. See [LED indicators on page 18](#) for details on the LED behavior.

- When the projector is powered on, press and hold for 2 seconds to power off.
- When the projector is powered on, short press to bring up the power menu. See [Setting the projector to power saving mode on page 39](#) for information on **Power Saving** and [Using the built-in speaker on the projector on page 47](#) for information on **Audio-Only Mode**.

3. FamiLand

Launches the **FamiLand** app in **Android TV**.

4. Arrow buttons (◀Left, ▶Right, ▲Up, ▼Down)

Used as navigation buttons to select the desired menu items and to make adjustments.

5. OK

Used to confirm selections.

6. Back

Returns to the previous menu.

7. Mute

Mutes the projector's audio.

8. Volume Up

Increases the projector volume.

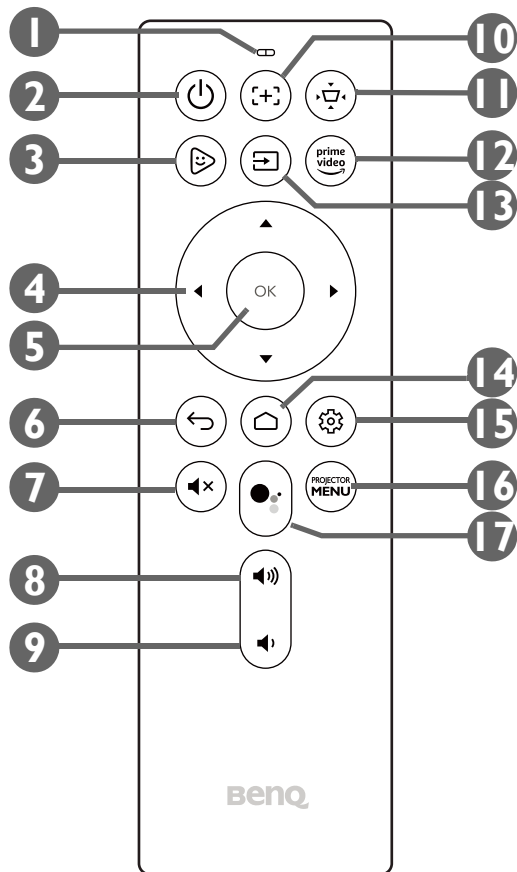

9. Volume Down

Decreases the projector volume.

10. (Not available to your projector)

11. Keystone

Adjusts the keystone for the projector. See [Correcting keystone on page 42](#) and [Installation on page 62](#) for more details.

12. Prime Video

Launches Amazon's Prime Video streaming service.

13. Source

Opens the input source menu.

14. Home

Returns to the **Android TV** home menu.

15. Settings

Launches the **Android TV** settings menu.

16. PROJECTOR MENU

Launches the projector's on-screen settings menu.

17. Google Assistant

Activates Google Assistant, Google's voice powered virtual assistant service. For more information on Google Assistant, including supported commands and phrases, check Google's official website.

Installing/Replacing the remote control batteries

Before you can begin to use the remote control, you must install the batteries into the remote control.

1. Slide the battery cover outwards.

 When sliding the battery cover, do not try to pull the cover too hard as it is tethered to the remote control by a plastic band and cannot be completely removed.

2. Insert the batteries in the orientation shown below.
3. Slide the battery cover back onto the remote control.

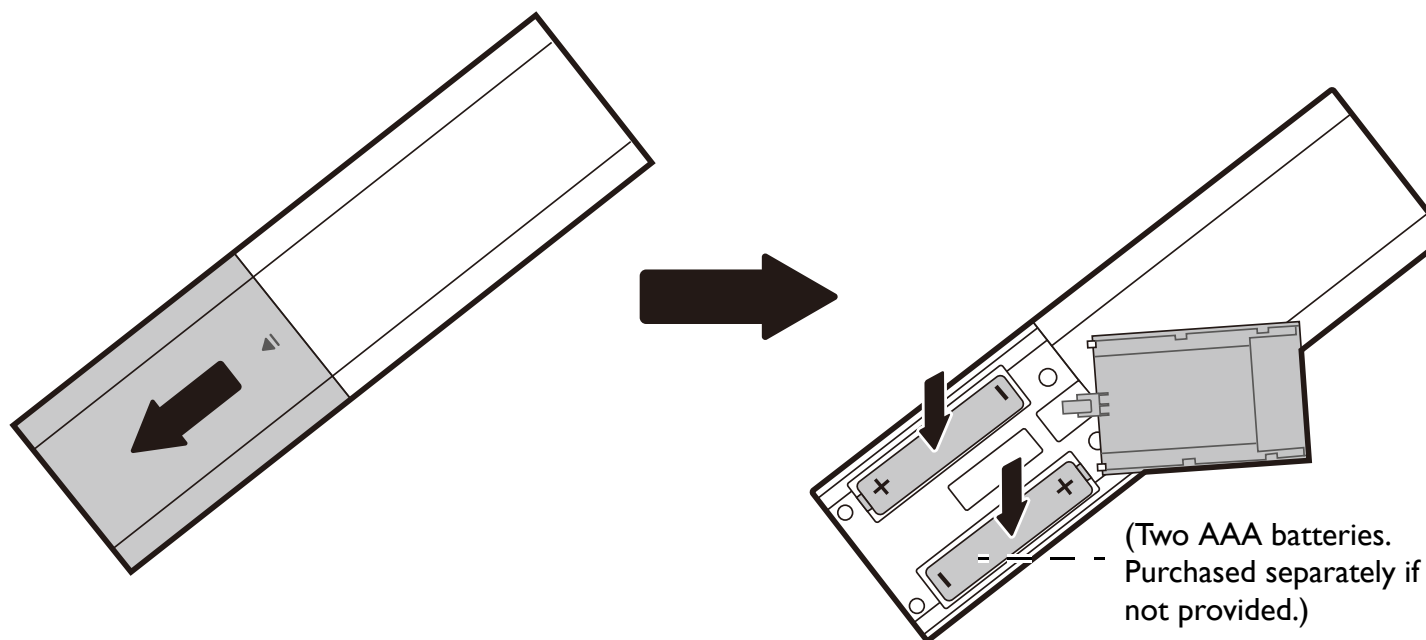

 Avoid leaving the remote control and battery in an excessively hot or humid environment like the kitchen, bathroom, sauna, sunroom or in a closed car.

Remote control effective range

The projector has an IR remote control sensor located at the front of the projector with a range of 8 meters (~26 feet) at an angle of 30 degrees (left and right) and 20 degrees (up and down). Prior to remote control pairing process during the setup wizard (see for [Starting up the projector on page 35](#) details), the remote control can only be used either by pointing it directly at the IR sensor or by reflecting the IR signal off of a wall/screen, making sure that there are no obstacles between the remote control and the IR sensor on the projector.

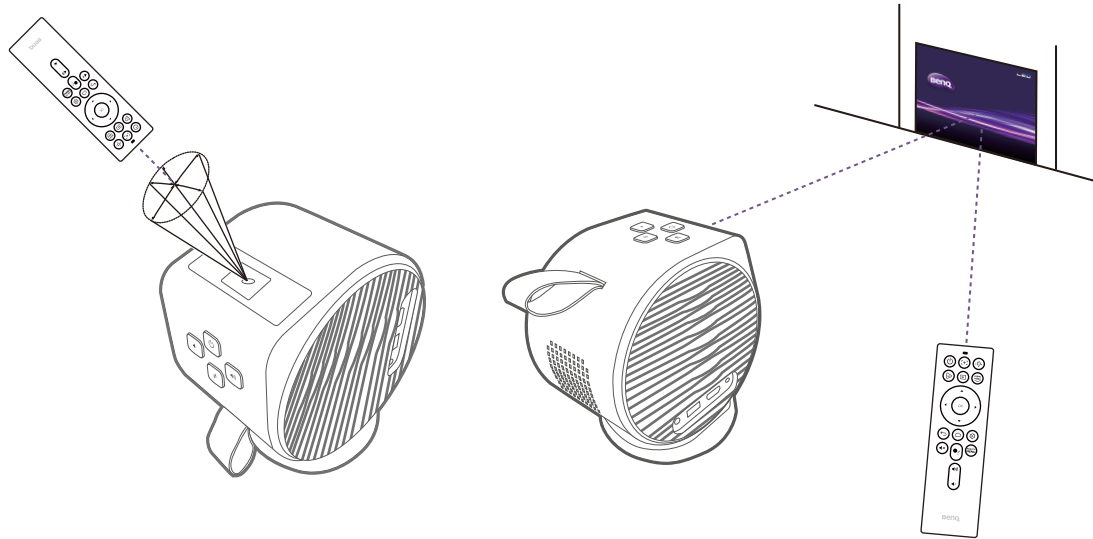

Once the remote control has been paired to the ATV dongle installed in the projector, you will be able to use it at any angle within a range of 7 meters (~23 feet).

 Voice input and Google Assistant functionality on the remote control is only available after the remote control has been paired to the projector during the setup wizard process. See [Starting up the projector on page 35](#) for more details.

BenQ Smart Control (remote control app)

The projector also supports the **BenQ Smart Control** app, which lets you transform your Android or iOS device into a remote control to control the ATV dongle (QS01) via buttons and/or touch gestures.

As there are various apps available to you, if you find the supplied remote control does not work well on some of the apps, try with **BenQ Smart Control**.

To begin using the **BenQ Smart Control** app, you need to complete the basic installation and initial setup as instructed in [Operations on page 32](#) first. Refer to the QS01 user manual (available from Support.BenQ.com) or scan the following QR code for instructions on **BenQ Smart Control** download and connection.

How-to video



How to use
Smart Control

-
-  You must be connected to the same wireless network as the projector for **BenQ Smart Control** to work correctly.
 - If the app does not automatically connect to your ATV dongle (QS01), or if multiple compatible products are connected to the same network, select the corresponding ATV dongle (QS01) you want to control from the list of products
-

Choose one of the following methods to use **BenQ Smart Control**:

- Tap **Mouse** to use touch gestures on your smartphone to control the cursor on the projector similar to a mouse.

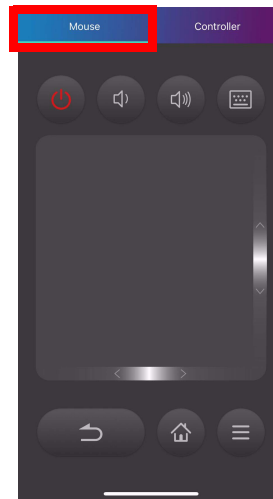

- Tap **Controller** to use the pre-configured buttons in the app to control your projector.

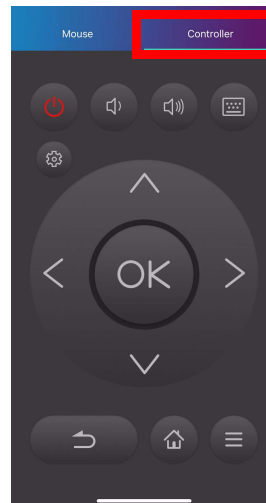

 The images are for reference only. The app may be subject to change without prior notice.

Installation

Choosing a location

Before choosing an installation location for your projector, take the following factors into consideration:

- Size and position of your screen
- Electrical outlet location
- Location and distance between the projector and the rest of your equipment
- Location and distance between the projector and the wireless access point

You can install your projector in the following ways:

1. Front Table:

Select this location with the projector placed near the floor in front of the screen.

This is the most common way to position the projector for quick setup and portability.

Turn on the projector and select the following settings in the projector's settings menu. See for [Installation on page 62](#) more details:

Installation > Projector Position > Front Table

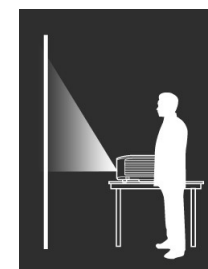

2. Front Ceiling:

Select this location with the projector elevated near the ceiling in front of the screen.

Turn on the projector and select the following settings in the projector's settings menu. See for [Installation on page 62](#) more details:

Installation > Projector Position > Front Ceiling

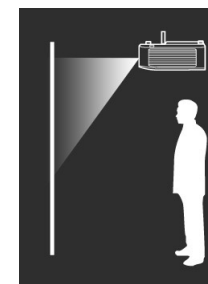

The projector does not feature ceiling mount components/equipment so when choosing to use a front ceiling location you must place it on an elevated location of your choice.

3. Rear Table:

Select this location with the projector placed near the floor behind the screen.

Turn on the projector and select the following settings in the projector's settings menu. See for [Installation on page 62](#) more details:

Installation > Projector Position > Rear Table



A special rear projection screen is required.

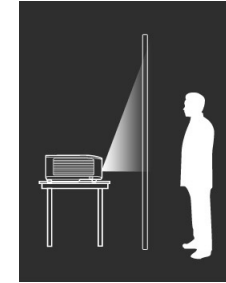

4. Rear Ceiling:

Select this location with the projector elevated from the ceiling behind the screen.

Turn on the projector and select the following settings in the projector's settings menu. See for [Installation on page 62](#) more details:

Installation > Projector Position > Rear Ceiling



A special rear projection screen is required.



The projector does not feature ceiling mount components/equipment so when choosing to use a rear ceiling location you must place it on an elevated location of your choice.

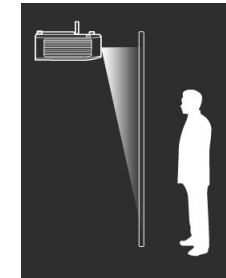

Moving the projector

Carry the strap to move the projector around. Hold the projector and its base carefully when you place them down on a flat surface to keep them stable.

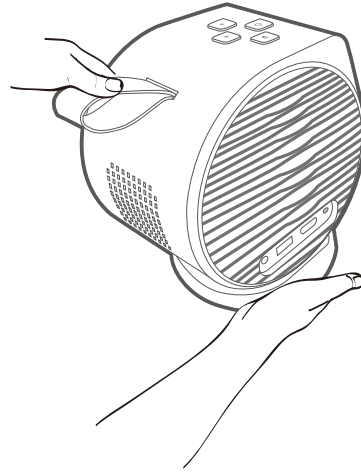

Obtaining a preferred projected image size

The projected image size is determined by the distance from the projector lens to the screen, and the video format. The data in the table below is based on a normal projection method and not the result of adjusting the projection angle (1-15 degrees).

Projection dimensions

Use the illustration and tables below to help you determine the projection distance.

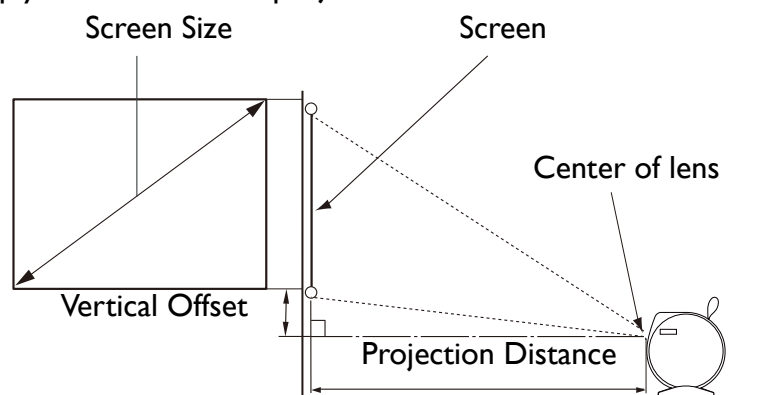

| Screen size | | | Projector distance (mm) | |
|-------------|------|--------|-------------------------|---------|
| Diagonal | | H (mm) | W (mm) | Average |
| Inch | mm | | | |
| 30 | 762 | 373 | 664 | 864 |
| 35 | 889 | 436 | 775 | 1007 |
| 40 | 1016 | 498 | 886 | 1151 |
| 45 | 1143 | 560 | 996 | 1295 |
| 50 | 1270 | 622 | 1107 | 1439 |
| 55 | 1397 | 684 | 1218 | 1583 |

| Screen size | | | Projector distance (mm) | |
|-------------|------|--------|-------------------------|---------|
| Diagonal | | H (mm) | W (mm) | Average |
| Inch | mm | | | |
| 60 | 1524 | 747 | 1329 | 1727 |
| 65 | 1651 | 809 | 1439 | 1871 |
| 70 | 1778 | 871 | 1550 | 2015 |
| 75 | 1905 | 933 | 1661 | 2159 |
| 80 | 2032 | 996 | 1771 | 2303 |
| 85 | 2159 | 1058 | 1882 | 2447 |
| 90 | 2286 | 1120 | 1993 | 2591 |
| 95 | 2413 | 1182 | 2104 | 2735 |
| 100 | 2540 | 1245 | 2214 | 2879 |

 All measurements are approximate and may vary from the actual sizes. If you want a permanent installation of the projector, we recommend that you use the actual projector to physically test the projection size, distance, and the projector's optical characteristics prior to the installation. This helps you determine the exact mounting position which best suits your installation.

Using the projector in an outdoor setting

The projector is designed mainly for indoor use but its portable design also allows it to support occasional outdoor use. When using the projector outdoors, the following items are suggested to enhance the viewing experience:

- Install the projector on a tripod if there is no flat surface to place the projector. See [Installing the projector on a tripod \(purchased separately\) on page 79](#) for more details.
- Set the picture mode to the most suitable setting (e.g. **Day Time** for a brightly lit environment). See [Picture Mode on page 61](#) for more details.

Operations

Installing the ATV dongle

1. Remove the cap from the provided ATV dongle.
2. Place the projector on a flat and stable surface covered by a protective sheet with its right cover facing up. Make sure the speaker and strap are facing toward you and the strap is on the right.
3. Slide to open the cover from the projector as illustrated.

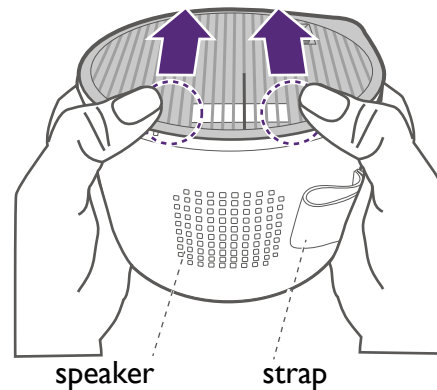

How-to instruction



Install dongle

4. Connect the power cable to the port on the side of the dongle (1) and then insert the dongle into the designated HDMI port (2) as illustrated until you hear the clack.

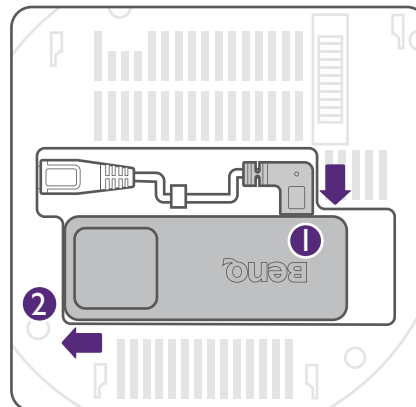

5. Aim the hole on the cover to the focus knob. Re-install the right cover onto the projector.

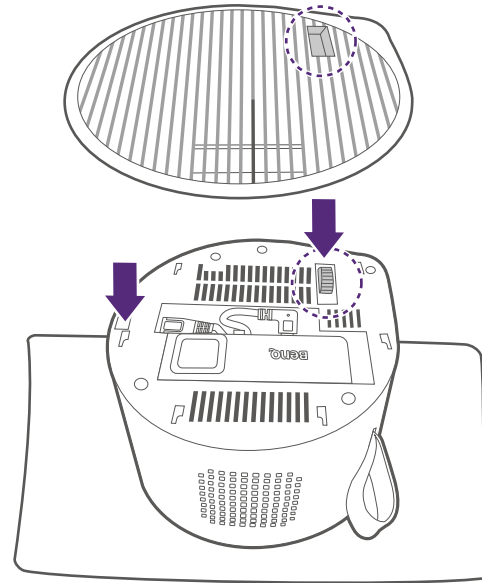

Assembling the adapter

Every adapter provided in the box includes a plug socket and plugs based on the region in which you purchased the product. Assemble an appropriate plug with the adapter before using the adapter.

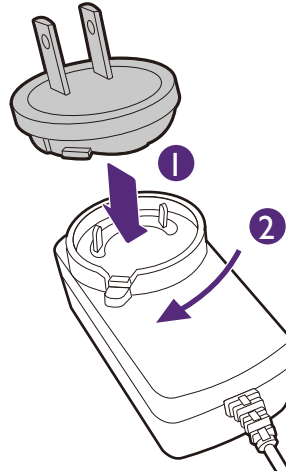

To change the plug, follow the illustration to release the current one first.

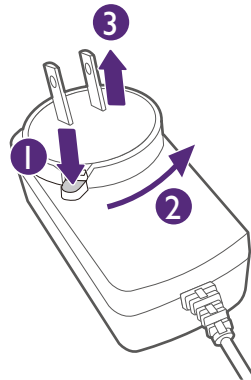

Charging the battery

1. Make sure the appropriate plug has been properly assembled as instructed in [Assembling the adapter \(page 34\)](#). Connect the adapter to the power adapter port.
2. Connect the power cord to a power outlet.

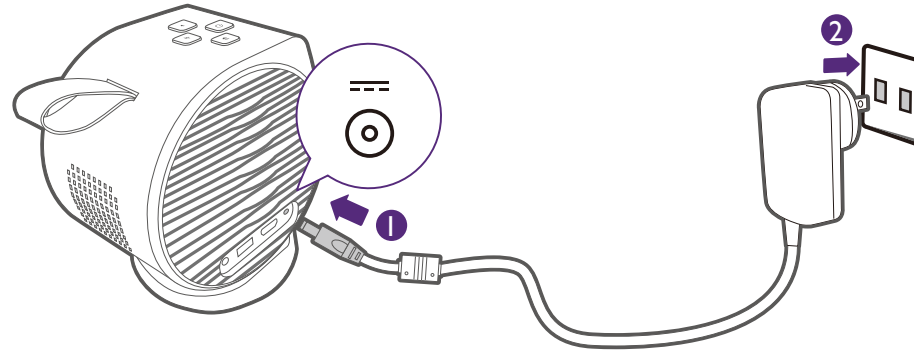

The power LED indicator will illuminate according to its charge status, for a full charge wait until the indicator lights up solid green (see [LED indicators on page 18](#) for more information on LED behavior). It takes about 2.5 hours.

Starting up the projector

! If you are starting up the projector for the first time, it is suggested that the projector is within range of a wireless access point (e.g. a router) with a stable Internet connection as some optional steps during the setup process require Internet access.

1. Install the provided ATV dongle into the designated HDMI port. See [Installing the ATV dongle on page 32](#) for details.
2. If you are starting up the projector for the first time, charge the battery or supply power to the projector until the power LED lights up in green as indicated in [Charging the battery on page 35](#). It takes about 2.5 hours.

3. Press and hold the power button  on the projector for over 2 seconds. The power LED will flash green pattern.

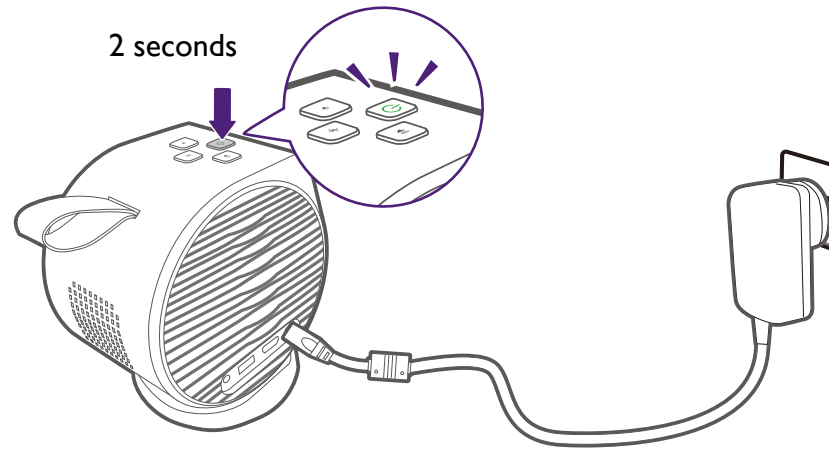

-
- When supplying power directly to the projector please use the supplied power cable to avoid possible dangers such as electric shock and fire.
 - Powering on via the remote control is not enabled by default. To enable it, go to **System > Use remote control to power on**.
 - Prior to pairing the remote control to your projector you must ensure that your remote control is in range of the projector's IR sensor. See [Remote control effective range on page 24](#) for more details.
 - Powering on via the remote control will not work if you have not completed the setup wizard procedure or if the projector's battery level is below 5%.
-

4. The fans will start operating and a start-up image will be shown while the projector warms up. This process may take a few minutes. The projector does not respond to further commands while it is warming up.
 5. If you are starting up the projector for the first time, the projector's setup wizard will appear to guide you through the initial hardware setup including selecting the system language and correcting keystone. Using your remote control, follow the on-screen instructions to proceed with the process.
-

 The screenshots above are for reference only and may differ from the actual design.

6. Once you've completed the projector's setup wizard, the projector will begin the **Android TV** setup wizard to guide you through setting up the projector's operating system, including steps for pairing the remote control, selecting the language for **Android TV**, setting up a Wi-Fi connection, signing in to a Google account, and other related steps.

7. If you are starting up the projector for the first time, upgrade the projector's firmware to the latest version. See [Upgrading your projector on page 42](#) for more information.



- Pairing your remote control to the projector and connecting to a network are required steps in order to proceed with the **Android TV** setup process. You will not be able to use your projector's **Android TV** operating system until you have completed both steps. You will still be able to project via a wired connection if you do not complete the **Android TV** setup process.
- You may proceed with the **Android TV** setup process without signing into a Google account, but you will have limited use of **Android TV**'s services and will be prompted to sign in any time you attempt to use these services.
- To find out how to quickly set up your Google account on the projector, scan one of the QR codes below based on your mobile device's operating system and watch the how-to video.

- **With iOS device**

<https://www.benq.com/en-us/knowledge-center/knowledge/how-to-start-benq-smart-home-projector.html#S1>



- **With Android device**

<https://www.benq.com/en-us/knowledge-center/knowledge/how-to-start-benq-smart-home-projector.html#S2>



8. Once you've completed the **Android TV** setup wizard, the **Android TV** home screen will appear.

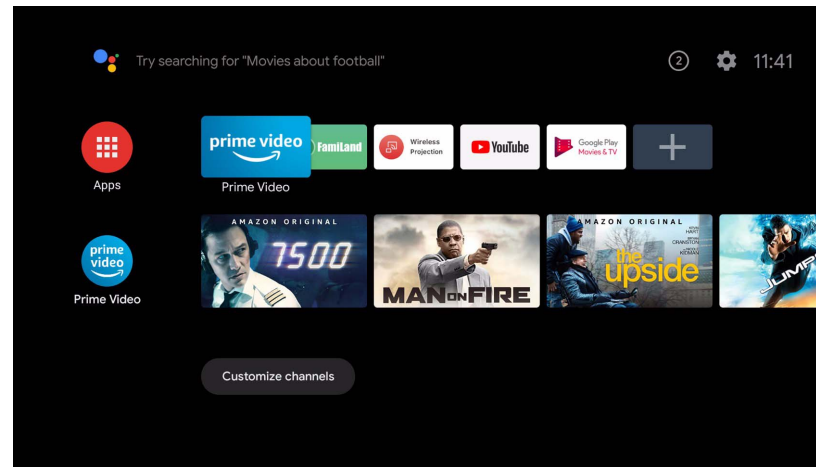

You may enjoy streaming services now. See [Android TV on page 44](#) for more information. Or you may connect a device to the projector to project video. See [Connections on page 49](#) for more information.



The screenshots above are for reference only and may differ from the actual design.

Shutting down the projector

1. Press and hold the power button  on the projector for over 2 seconds will shut down directly.
 2. The power LED will flash a breathing green pattern (see [LED indicators on page 18](#)). The fans may continue to run in order to cool the system.
- If the projector will not be used for an extended period, unplug the power cable from the power outlet and remove the batteries from the remote control.

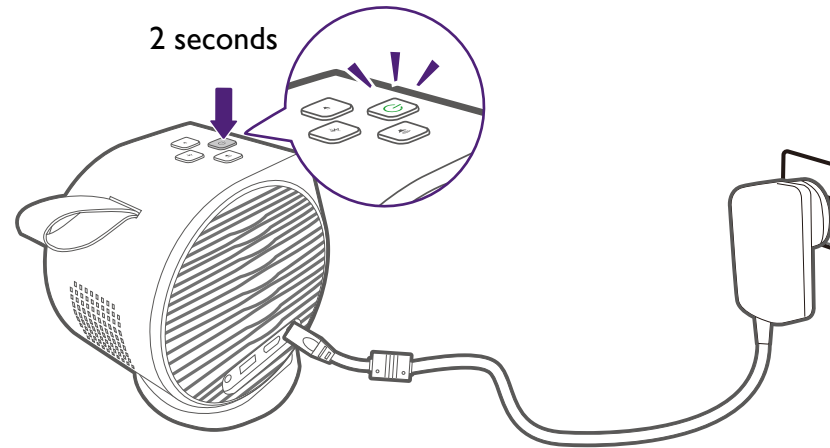

Setting the projector to power saving mode

To save power, you can set the projector and the ATV dongle to power saving mode when they are not in use.

1. Press the power button on the projector or remote control to bring up the power menu.
2. Select **Power Saving** to enable power saving mode. The light source will be turned off, and the fan speed will be reduced. The projector will be turned off automatically in 15 minutes if there is no further action to the projector.
3. To exit power saving mode, press any key on the projector or remote control, and the screen will be back.

Adjusting the projected image

Adjusting the projection angle

The projector features a base that holds the projector and allows you to adjust the projection angle.

Place the projector properly on the base until it clicks, and rotate the projector to adjust the projection angle.

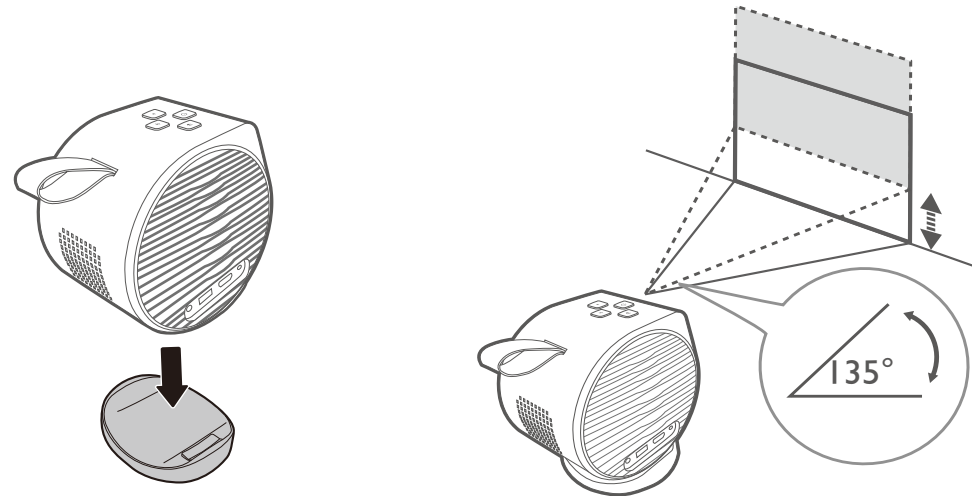

-
- The maximum angle of adjustment is 135 degrees.
 - If the screen and the projector are not perpendicular to each other, the projected image becomes trapezoidal. To correct this, see [Correcting keystone on page 42](#) for details.
-

 When the projector is on, **DO NOT** place down the projector with its left or right vents facing down as this will block the vents.

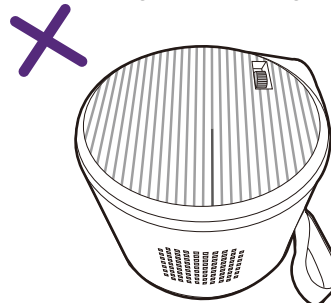

Fine-tuning the image clarity

To sharpen the picture, manually turn the focus knob on the right side of the projector to focus the image.

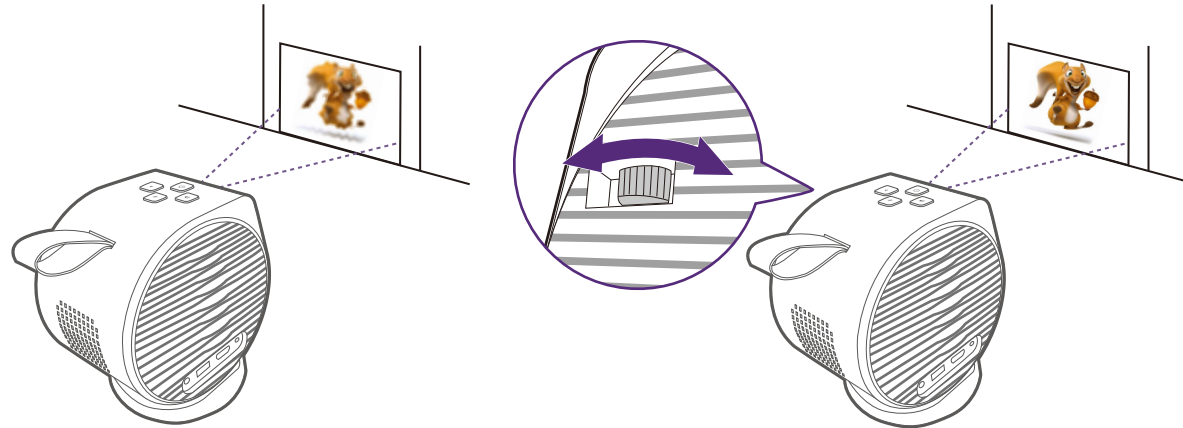

Do not look into the lens while the light is on. The strong light from the light may cause damage to your eyes.

Correcting keystone

The keystone effect refers to the situation where the projected image is noticeably wider at either the top or bottom. It occurs when the projector is not perpendicular to the screen. To correct the keystone effect press the keystone button  on the remote control and then follow the on-screen instructions to make the adjustments.

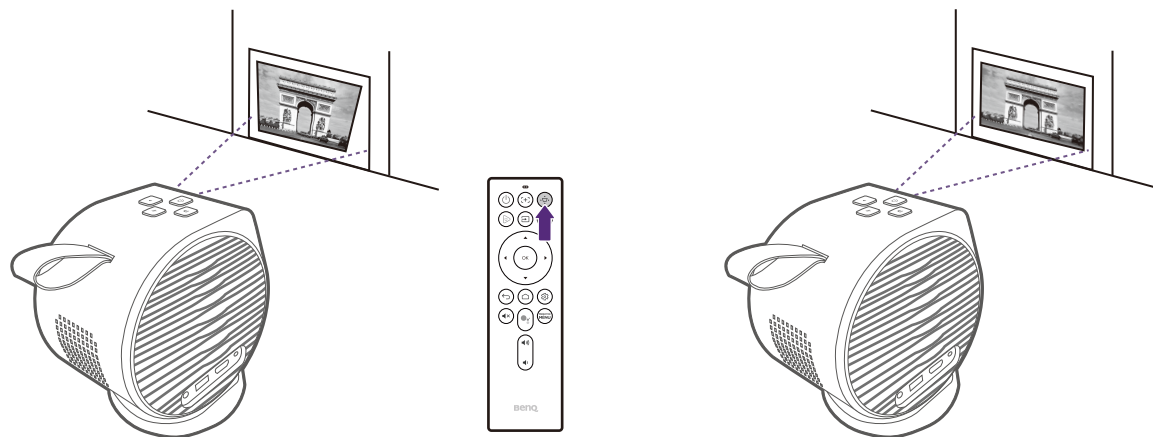

When you are done making the adjustments, press  to save your changes and return to the previous menu.

Upgrading your projector

It is suggested that you update the projector with the latest version of the firmware to optimize the user experience.

How-to video



Firmware upgrade

1. Find out the current firmware version of your projector. Go to **System > Projector Information > Firmware Version** on your projector.
2. Visit Support.BenQ.com and download the new firmware files (if available) of your projector. Save the firmware files to a USB flash drive in FAT32 disk format. You should download the latest user manual for reference as well.
3. Keep stable power supply to the projector via power adapter. Do not power off the projector.
4. Connect the USB flash drive to the USB port of your projector.
5. Go to **System > System Update > USB Update** on your projector to start the upgrade. Wait until the BenQ Launcher appears on the screen and the upgrade is complete.

 Check if there are updated firmware files and user manual of QS01 ATV dongle from Support.BenQ.com. Find out the updates from the upgrade notice. If a new firmware version is available, you are recommended to upgrade the dongle for best performance.

Android TV

Android TV is the projector's operating system that allows you to project videos wirelessly and use streaming apps.

The **Android TV** home screen

Upon initial startup or when the input source is set to **ATV** the projector will display the **Android TV** interface. If the projector is projecting from a source, you can return to **Android TV** by pressing \square on your remote control or by selecting **ATV** in the input source menu.

The **Android TV** home screen features following items:

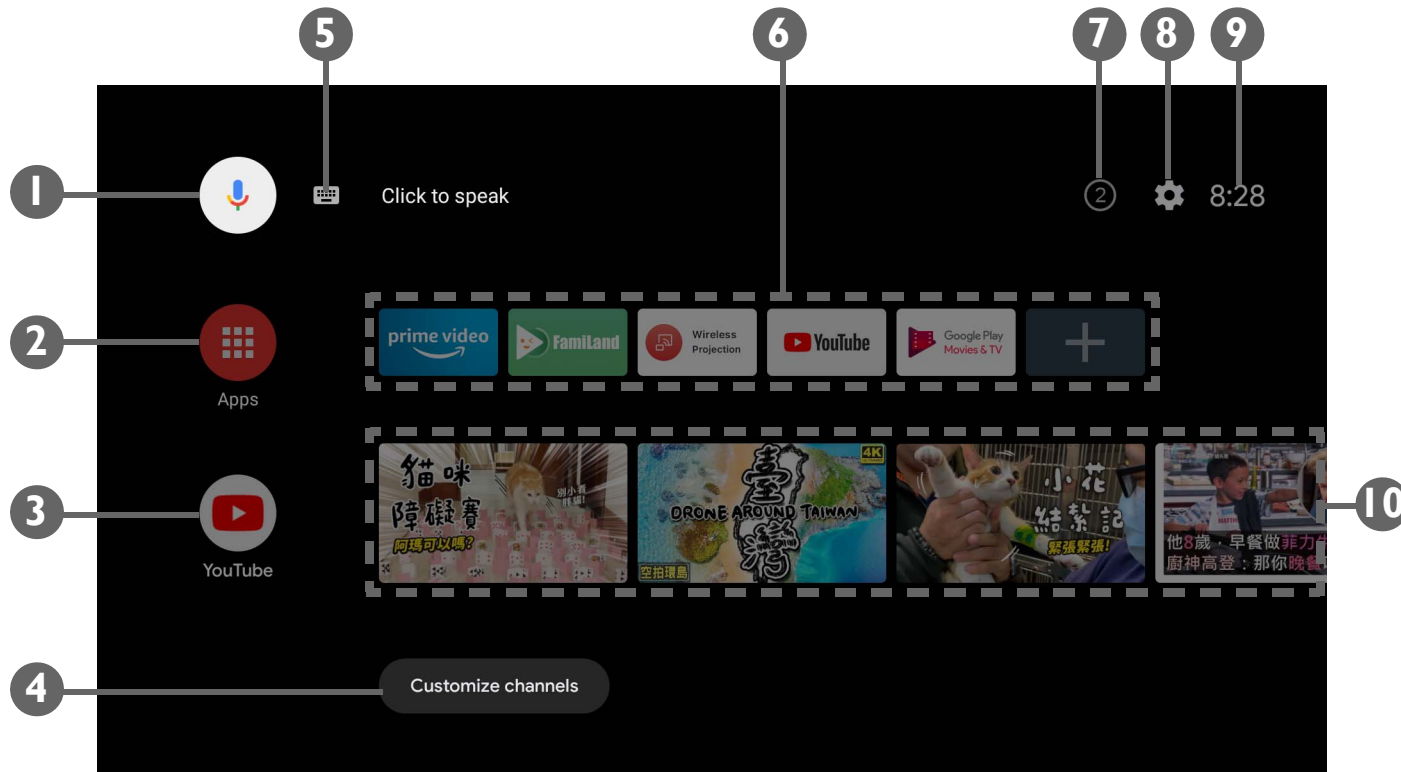

Actual screen may vary based on your **Android TV** version.

| No. | Item | Description |
|-----|--|---|
| 1 | Google Voice Search / Google Assistant | Enables Google Voice Search / Google Assistant. |
| 2 | All apps | Accesses all the installed apps. |
| 3 | YouTube | Launches the YouTube app. |
| 4 | Customized channels | Allows you to customize app channels that appear on the home screens feed. |
| 5 | Search by text | Enables text input to search. |
| 6 | Recommended apps or services | Quick access to recommended apps or videos-on-demand services. Select the + button to add app shortcuts to this row. See Accessing more streaming videos on page 47 for more information on streaming videos. |
| 7 | Notifications | Accesses notification(s). |
| 8 | Settings | Accesses the Android settings menus. |
| 9 | System time | Displays the time. |
| 10 | Recommended YouTube videos | Quick access to videos recommended by YouTube. |

For more information on Android TV, you can use the following resources:

- For How-to videos on Android TV and FamiLand, scan the QR code below or go to:
<https://www.benq.com/en-us/knowledge-center/knowledge/how-to-start-benq-smart-home-projector.html>



- For the QS01 ATV dongle user manual, visit Support.BenQ.com.

Google Assistant

Android TV supports Google Assistant, Google's voice powered virtual assistant service, for basic commands and Google searches. To activate Google Assistant press the Google Assistant button  on the remote control and say your command or question into its microphone. For more information on Google Assistant, including supported commands and phrases, check Google's official website.

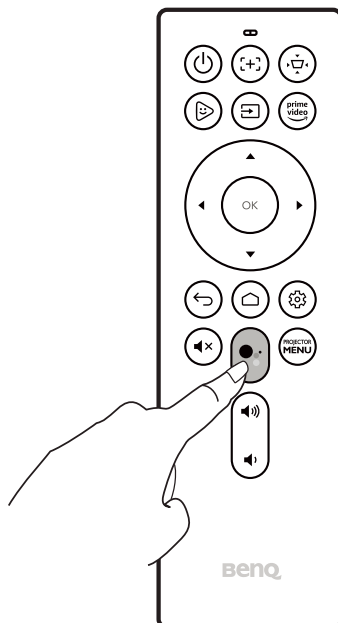

Playing music via the projector

With the built-in speakers, you can enjoy music playback via the projector without a projection screen. The projector can work as an ordinary speaker or a Bluetooth speaker.

Using the built-in speaker on the projector

1. Access a music streaming service or a music channel from **Android TV**.
2. Start the music playback.
3. Press the power button  on the projector or remote control to bring up the power menu.
4. Select **Audio-Only Mode**. The screen is turned off while the music playback continues.
5. To stop the playback or to perform other operations, press any key on the remote control to bring the projection screen back.

Using the projector as a Bluetooth speaker

See [Using the projector as a Bluetooth speaker \(page 55\)](#) for details.

Accessing more streaming videos

Some streaming service apps are not natively available on your ATV dongle. Refer to the QS01 user manual (available from Support.BenQ.com) for more information.

Refer to the QS01 user manual (available from Support.BenQ.com) for instructions on how to access more video streaming apps. Before you start, make sure your ATV dongle (QS01) is connected to the Internet.

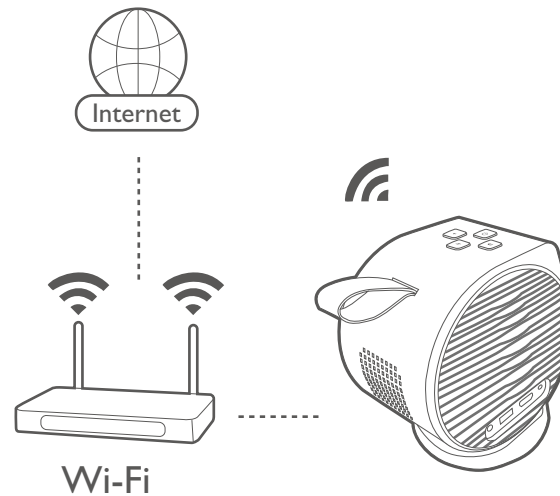

 As there are various apps available to you, if you find the supplied remote control does not work well on some of the apps, try with **BenQ Smart Control**. See [BenQ Smart Control \(remote control app\)](#) on page 25 for more information.

Connections

You can connect your device to the projector in various ways to project video content.

Wireless Connection

- Smartphone, tablet, laptop/PC

Wired Connection (HDMI port)

- A/V device.
- Smartphone, tablet, laptop/PC

Wired Connection (USB-A port)

- USB-A flash drive
- Smartphone, tablet, laptop/PC

Furthermore, you can also connect the projector to Bluetooth speakers/headphones to broadcast audio through the speakers/headphones or connect a mobile device to the projector via Bluetooth to broadcast audio through the projector's speakers.

Before making any wireless connections, be sure to:

- Install the provided ATV dongle for wireless connection.
- Place the projector within range of the wireless AP you plan to connect it to.

Before making any wired connections, be sure to:

- Use the correct cables for each source and make sure the cables are firmly inserted.

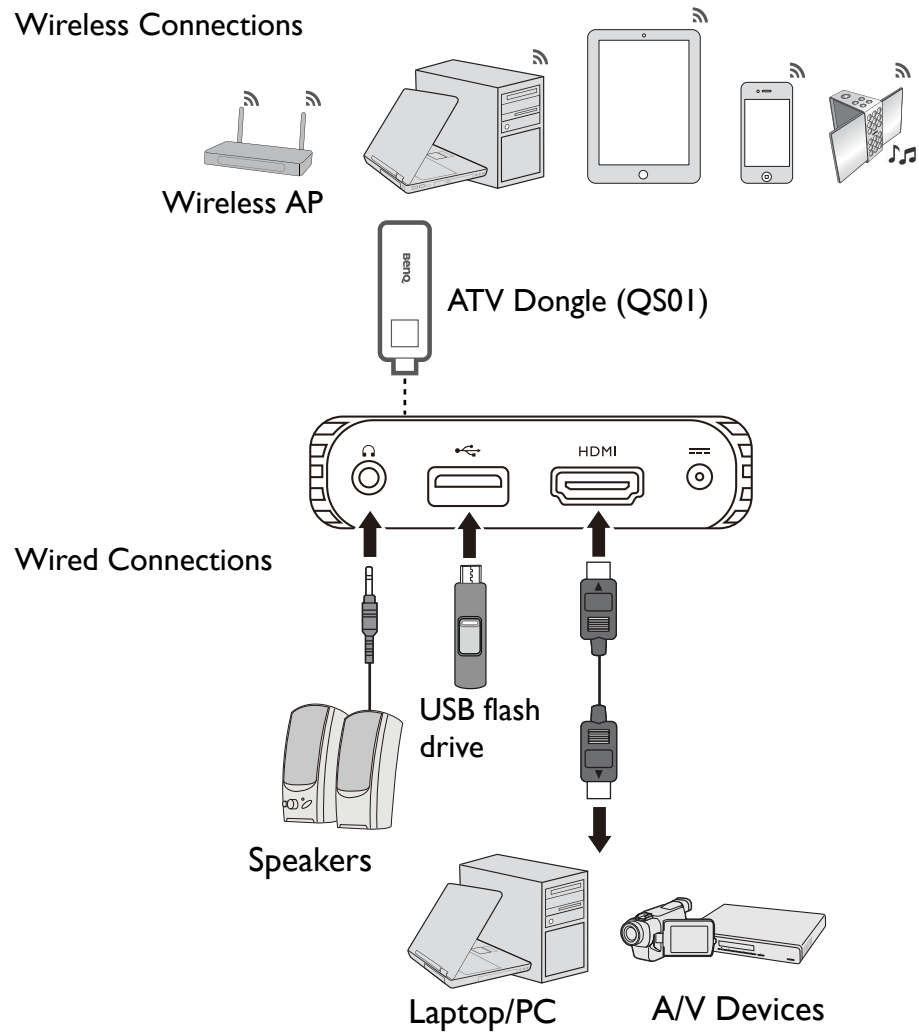

 The illustration above is for reference only.

Switching between **Android TV** and input sources

By default, the projector will enter the **Android TV** interface any time it is powered on. Once powered on, when a device is connected to one of its input ports the projector will automatically switch over to that input source.

To switch between input sources and **Android TV**, press the source button  on the remote control and select the desired input source from the source menu.

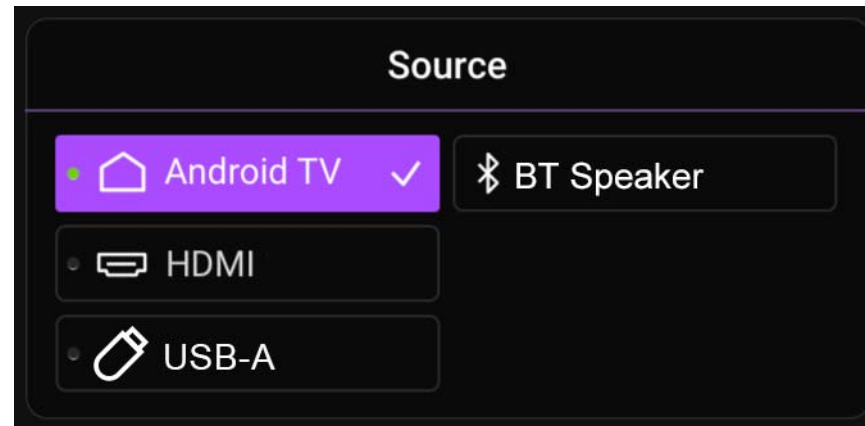

You can also press the home button  on the remote control to return to the **Android TV** home screen at any time.

Wireless connections

Before you can project wirelessly via the projector you must first connect the projector to a wireless network. Depending on your mobile device, different procedures and options are required. Follow the instructions.

Wireless projection

To wirelessly connect a device to the projector for the first time, you need to launch the **Wireless Projection** app from the **Android TV** Home screen on the projector to activate the function automatically.

Refer to the QS01 user manual (available from [Support.BenQ.com](https://support.benq.com)) or scan the following QR codes for instructions on how to perform wireless projection.

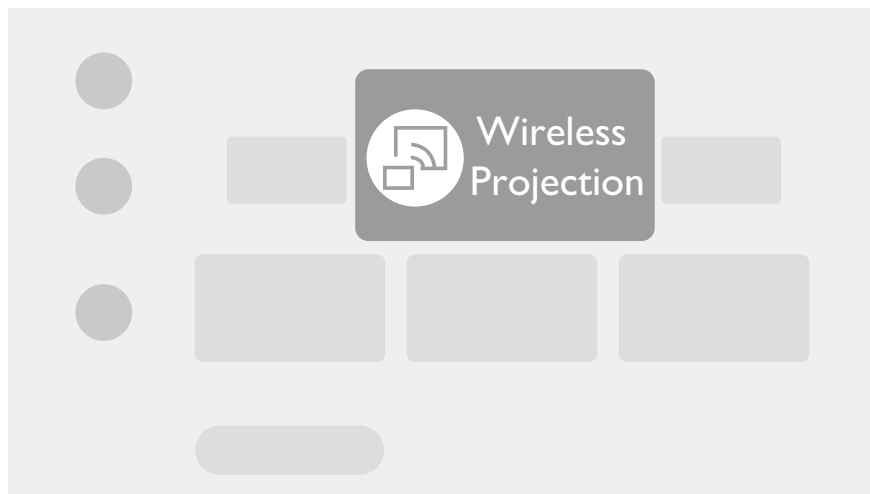

How-to video



Wireless projection
from iOS



Wireless projection
from Android

-
- To download the QS01 user manual, visit [Support.BenQ.com](https://support.benq.com).
 - The projector supports wireless projection via the AirPlay (for iOS devices) or Chromecast built-in (for Android devices). As a result, not all Android devices are able to wirelessly project on the projector. To check if your Android device supports wireless casting via Chromecast built-in, check support.google.com.
 - Netflix only supports specific authorized devices and is not natively available on BenQ smart home projectors. Please follow the recommended viewing procedures in [this how-to video](#) to cast your screen from a projector. Visit [Support.BenQ.com](https://support.benq.com) and check out the QS01 product page for details.
-

Wired connections



Connecting a device with HDMI

Using an HDMI cable you can connect a device that is equipped with HDMI capability to play videos and images on the projector.

1. Connect the device to the HDMI port on the projector. A pop-up notification will appear indicating that a device is connected.
2. Confirm whether you want to project video from the device. The video from the device will be displayed once the signal from the device is detected.



If no signal is detected or the signal is interrupted a message will appear.

3. Use the source menu or press the home button  to exit and go back to the **Android TV** home screen.
4. If the device remains connected and you want to project its video again, press the source button , and then select the corresponding port in the source menu.



- Some computers feature HDMI ports that do not transmit audio, in such cases a separate audio cable must be connected to the projector.
 - Some laptops do not turn on their external video ports when connected to a projector. Usually a key combination like **Fn + F3** or CRT/LCD key turns the external display on/off. Locate a function key labeled CRT/LCD or a function key with a monitor symbol on the laptop. Press **Fn** and the labeled function key simultaneously. Refer to your laptop's documentation to discover your laptop's key combination.
-

Connecting a USB flash drive

Connect a USB flash drive to the respective port on the projector to play media files stored on the USB flash drive.

To play media files stored on a USB flash drive:

1. Connect the USB flash drive to the USB port. A pop-up notification will appear indicating that a storage device is connected.
2. Select the type of media file you want to play.

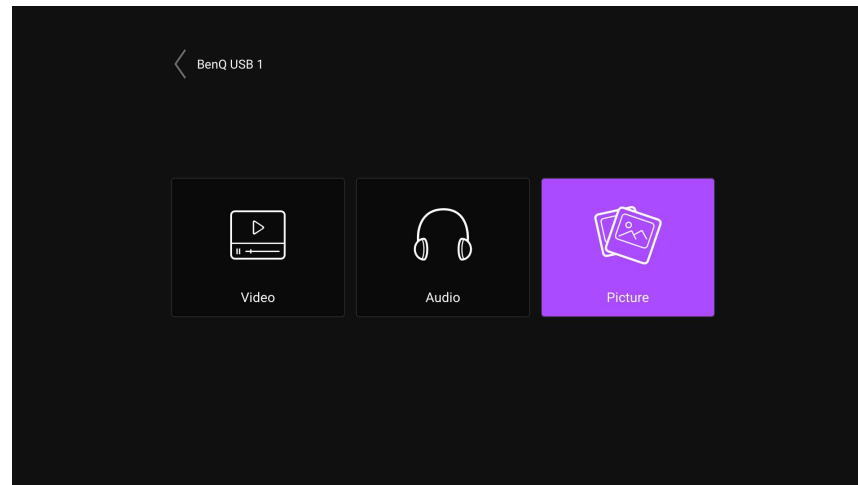

3. Navigate to and select the media file you want play. The projector's media player will launch.

Bluetooth connections

The projector allows the following types of Bluetooth connections:

- Connect a mobile device to the projector to play audio files through the projector's speakers.
- Connect to a Bluetooth-enabled speaker or headphones to output audio directly for greater sound.

Using the projector as a Bluetooth speaker

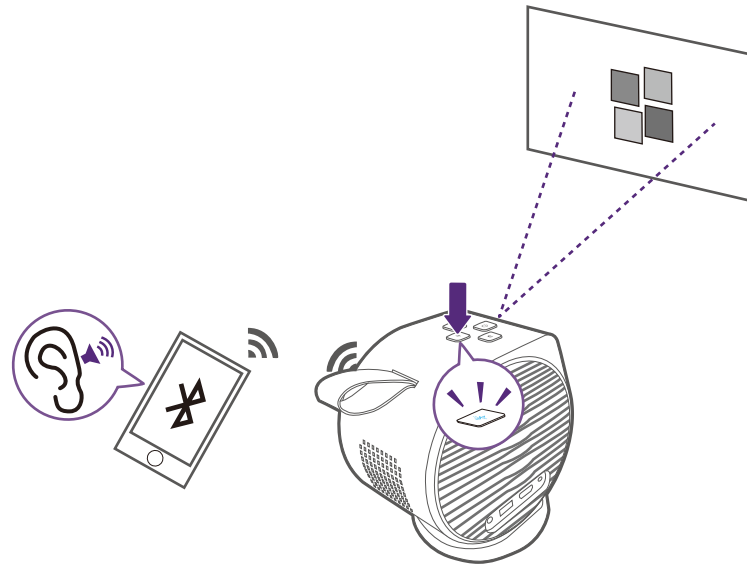

1. Make sure the ATV dongle is installed properly (see [Installing the ATV dongle on page 32](#)).
2. Power on the projector (see [Starting up the projector on page 35](#)).
3. Press the Bluetooth button  on the top side of the projector. The projector will stop projecting and switch over to Bluetooth speaker mode.



You may also enable Bluetooth speaker mode by pressing the source button  on the remote control and selecting **BT Speaker**.



4. Pair your external device to the projector.

After you have successfully paired your mobile device with the projector, pairing information will be stored on both devices and a connection will automatically be made when Bluetooth is enabled on both devices and both devices are within range of each other.

 If you are unable to activate Bluetooth mode or if the Bluetooth LED does not illuminate, shut off the projector and check to see if the ATV dongle is properly installed. See [Installing the ATV dongle on page 32](#) for details.

Ending the Bluetooth connection

In cases where you want to disconnect the mobile device from the projector, either:

- Disconnect from the projector in the Bluetooth menu of your mobile device.
- Press the Bluetooth button  on the projector to return the projector to projector mode.
- Press and hold the power button  on the projector or remote control to power off the projector.

Pairing/Connecting to a Bluetooth speaker or headphones

The Bluetooth function for your projector is built in the Android system, whose hardware is independent of other input sources like HDMI. Thus, the Bluetooth function will only be available when using the projector's built-in Android as an input source. In other words, due to current hardware limitations, the projector won't be able to transmit audio using HDMI to external Bluetooth speakers. If you have any further questions, please contact your local customer care team for more assistance.

1. Make sure the ATV dongle is installed properly (see [Installing the ATV dongle on page 32](#)).
2. Power on the projector (see [Starting up the projector on page 35](#)).
3. Press the settings button  on the remote control
4. Select **Remotes & Accessories**.
5. Select **Add accessory**.
6. Activate Bluetooth-pairing mode on the speaker or headphones.
7. Select the speaker or headphones from the device list shown on screen.
8. Select **Pair**.

When the projector and speaker or headphones have successfully connected, the device will be labelled as **Connected** in the **Remotes & Accessories**. You can now output the audio from the ATV to the speaker or headphone.

 The projector can only transmit audio from ATV via Bluetooth connection. Even when the projector is switched to other input sources, such as HDMI, as ATV is still running in the background, it will continue to transmit audio from ATV to the connected Bluetooth speaker or headphones.

Disconnecting a Bluetooth speaker or headphones

To disconnect a Bluetooth speaker or headphone from the projector so that it no longer outputs the projector's audio:

1. Press the settings button  on the remote control
2. Select **Remotes & Accessories**.
3. Select the speaker or headphones you want to disconnect from the device list shown on screen.
4. Select **Unpair**.

Navigating the settings menu

About the settings menu

To let you make various adjustments or settings on the projector, the projector provides a **Settings** menu. To access the menu, either press the **PROJECTOR MENU** button on the remote control or select **All Projector Settings** from the Android TV **Settings** menu.

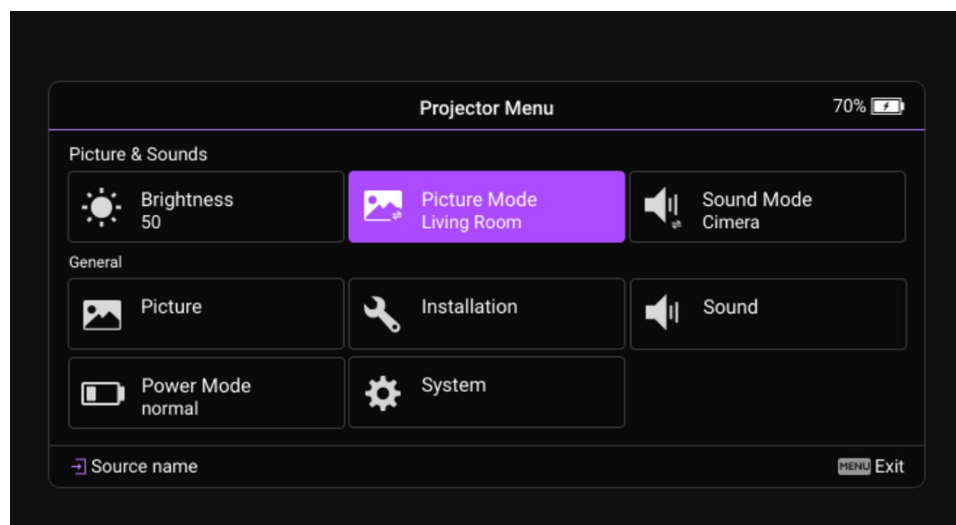
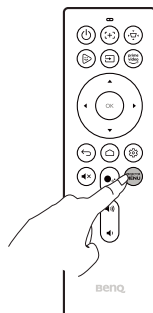

- For settings related to the system including wireless connection, account, and app related setting, use the Android TV **Settings** menu accessible on the home screen. See [The Android TV home screen on page 44](#) for more details.
- The screenshots above are for reference only and may differ from the actual design.

Using the **Settings** menu

To access the various settings menus:

- Use the arrow buttons (▲/▼/◀/▶) to move through the main settings menus.

- Use **OK** to select the desired menu.

When configuring items within a menu:

- Use the up and down arrow buttons (▲/▼) to move to the item you want to configure.

- Use **OK** to select sub-menu options.

- Use the arrow buttons (▲/▼ ◀/▶) to toggle through the available options.

- Use the back button ↶ to return to the main settings menu.

- Use the home button ◻ to return to the **Android TV** home screen.

Brightness

Allows you to adjust the brightness of the projector on a scale of 0 to 100.

Picture Mode

The following table describes the items available in the **Picture Mode** menu:

| Item | Options and descriptions |
|--------------------|---|
| Bright | Maximizes the brightness of the projected image. This mode is the brightest mode on your projector. |
| Living Room | With well-saturated colors and fine-tuned sharpness, this mode is slightly brighter than Cinema mode and suitable for playing TV streaming under a small amount of ambient light. |
| Game | Picture settings appropriate for playing video games. This mode especially enhances details in dark scenes so that enemies cannot hide. |
| Sports | With well-saturated colors, this mode is best for watching sporting events. |
| Cinema | With accurate colors and deepest contrast at a lower brightness level, this mode is suitable for playing movies in an environment with a bit of ambient light. |
| Day Time | By brightening dim regions of images, this mode is suitable for use in lit spaces. |

Sound Mode

Sound Mode utilizes sound enhancement technology, which incorporates Waves' algorithms to deliver great effects of the bass and treble and provide you with immersive cinematic audio experience. The available options include: **Standard**, **Cinema**, **Music**, and **User**.

Cinema is recommended for movie watching, while **Music** is recommended for music playback and vocals (e.g., songs and podcasts). You can customize settings with **User** mode. Go to [Sound on page 63](#) for more information.

Picture

The following table describes the items available in the **Picture** menu:

| Item | Options and descriptions |
|---------------------|---|
| Picture Mode | Allows you to switch between picture modes. See Picture Mode on page 61 for more details |
| Brightness | Allows you to adjust the brightness of the projector on a scale of 0 to 100. |
| Contrast | The higher the value, the greater the contrast. Use this to set the peak white level after you have previously adjusted the Brightness setting to suit your selected input and viewing environment. |
| Color | Lower setting produces less saturated colors. If the setting is too high, colors on the image will be overpowering, which makes the image unrealistic. |
| Sharpness | The higher the value, the sharper the picture becomes. |

Installation

The following table describes the items available in the **Installation** menu:

| Item | Options and descriptions |
|-------------------------------------|---|
| Projector Position | Chooses the position in which the projector is installed. See Choosing a location on page 27 for more details. |
| Auto Vertical Keystone | Enables/Disables the projector's automatic keystone adjustment. |
| Vertical Keystone Correction | Allows you to manually adjust the keystone settings for the projected image. See Correcting keystone on page 42 for more details. |
| HDMI Format | Selects a suitable color format to optimize display quality. |

| Item | Options and descriptions |
|---------------------------|--|
| Aspect Ratio | <p>There are several options to set the image's aspect ratio depending on your input signal source. Options include:</p> <ul style="list-style-type: none"> • Auto: Scales an image proportionally to fit the projector's native resolution in its horizontal or vertical width. • Real: Projects an image as its original resolution and resizes it to fit within the display area. For input signals with lower resolutions, the projected image will be displayed in its original size. • 4:3: Scales an image so that it is displayed in the center of the screen with a 4:3 aspect ratio. • 16:9: Scales an image so that it is displayed in the center of the screen with a 16:9 aspect ratio. |
| Test Pattern | <p>Displays the test pattern grid, which helps you adjust the image size and focus to check if the projected image is free of distortion.</p> |
| High Altitude Mode | <p>We recommend you use the High Altitude Mode when your environment is between 1500 m - 2000 m above sea level, and ambient temperature is between 0°C to 30°C.</p> <p>Operation under High Altitude Mode may cause a higher decibel operating noise level because of increased fan speed necessary to improve overall system cooling and performance.</p> <p>If you use this projector under other extreme conditions excluding the above, it may display auto shut-down symptoms, which is designed to protect your projector from over-heating. In cases like this, you should switch to High Altitude Mode to solve these symptoms. However, this is not to state that this projector can operate under any and all harsh or extreme conditions.</p> <p> Do not use the High Altitude Mode if your altitude is between 0 m and 1500 m and ambient temperature is between 0°C to 35°C. The projector will be over cooled, if you turn the mode on under such a condition.</p> |

Sound

Access to preset sound modes, If you prefer to customize different frequency levels, you can select **User** and make adjustments.

Power Mode

The following table describes the items available in the **Power Mode** menu:

| Item | Options and descriptions |
|------------------------------|---|
| Normal | 100% LED brightness. This mode is available only when the power is supplied from the power adapter. |
| Eco | This setting reduces power consumption by 10%. If Eco is selected, the light output will be reduced and result in darker projected pictures. |
| Low power consumption | Lowers brightness to around 50% to extend the LED life, and reduces noise by around 10%. |

System

The following table describes the items available in the **System** menu:

| Item | Options and descriptions |
|---------------------------------------|---|
| Language | <p>Sets the language for the projector.</p>  Changing the language setting in this menu will not change the language used in Android TV . To change Android TV 's language use the settings menu on the home screen. |
| Use remote control to power on | <p>Sets to power on the projector via the power button on the remote control. Once enabled, the projector scans for remote control signals when it is powered off and may drain battery power quickly.</p> |
| System Update | Allows you to update the software on the projector via a USB flash drive. |
| System Information | Displays hardware/software information for the projector including its device name and serial number. |
| Projector Information | Displays information on the current status of the projector including the current Detected Resolution, Source, Picture Mode, Power Mode, Color System, Light Usage Time, Firmware Version, and Service Code. |

| Item | Options and descriptions |
|----------------------|---|
| Factory Reset | Returns the projector to its factory default state. |

Maintenance

Care of the projector

Your projector needs little maintenance. The only thing you have to do on a regular basis is keep the lens clean.

Never remove any parts of the projector. Contact your dealer or local customer service center if the projector fails to operate as expected.

Cleaning the lens

Clean the lens whenever you notice dirt or dust on the surface.

Before cleaning any part of the projector, turn it off using the proper shutdown procedure (see [Shutting down the projector on page 39](#)), unplug the power cable, and let it cool down completely.

- Use a canister of compressed air to remove dust.
- If there is dirt or smears, use lens-cleaning paper or moisten a soft cloth with lens cleaner and gently wipe the lens surface.
- Never use any type of abrasive pad, alkaline/acid cleaner, scouring powder, or volatile solvent, such as alcohol, benzene, thinner or insecticide. Using such materials or maintaining prolonged contact with rubber or vinyl materials may result in damage to the projector surface and cabinet material.

 Never touch the lens with your finger or rub the lens with abrasive materials. Even paper towels can damage the lens coating. Only ever use a proper photographic lens brush, cloth, and cleaning solution. Do not attempt to clean the lens while the projector is switched on or is still hot from previous use.

Storing the projector

To store the projector for an extended time:

- Make sure the temperature and humidity of the storage area are within the recommended range for the projector. Refer to Specifications or consult your dealer about the range.
- Remove the batteries from the remote control.
- Pack the projector in its original packing or equivalent.

Transporting the projector

It is recommended that you ship the projector with its original packing or equivalent.

Outdoor use

Anytime the projector is used outdoors, remember to follow the care instructions in this chapter and the cleaning instructions described in [Important safety instructions on page 9](#).

Extending LED life

The LED headlight includes a bulb which features a light-source life far beyond traditional bulbs, yet it is still a consumable item. To keep the LED life as long as possible, you can change the following settings via the settings menu.

To access the settings menu, see [Using the Settings menu on page 60](#) for details.



LED replacement is not user-serviceable. When it is needed, please contact the service center.

Setting LED Mode

Set the projector **Power Mode** to **Eco** or **Low power consumption** to extend the LED life.

| LED mode | Description |
|------------------------------|---|
| Normal | 100% LED brightness. This mode is available only when the power is supplied from the power adapter. |
| Eco | This setting reduces power consumption by 10%. If Eco is selected, the light output will be reduced and result in darker projected pictures. |
| Low power consumption | Lowers brightness to around 50% to extend the LED life, and reduces noise by around 10%. |

1. Press the **PROJECTOR MENU** button on the remote control.
2. Select **Power Mode**.
3. Press (**▲/▼**) to move to your desired mode.

4. When done, press to \supset your changes and exit.

Troubleshooting

If your problems remain after checking this manual, please contact your place of purchase or visit the local website from Support.BenQ.com for more support and local customer service.



Support.BenQ.com

| Problem | Cause | Remedy |
|---|---|---|
| The projector does not turn on. | There is no power from the power cable. | Plug the power cable into the AC inlet on the rear of the projector, and plug the power cable into to the power outlet. If the power outlet has a switch, make sure that it is switched on. |
| | The battery is running out and in low voltage. | Plug in power adapter to charge the projector until the LED indicator turns solid green; then press and hold the power button on the projector for 3 seconds to turn it on. |
| The projector cannot connect with Bluetooth speakers or headphones. | The Bluetooth function is not enabled. | Make sure the Bluetooth function on both the Bluetooth device and the projector are enabled. See Pairing/Connecting to a Bluetooth speaker or headphones on page 56 for more details. |
| | The Bluetooth device and the projector are not within an 8 meter range of each other. | |
| The projector cannot play files in storage devices via USB-A ports. | The storage device is not connected to the projector properly. | Make sure your storage device is fully inserted into the USB-A port on the projector. |
| | The projector does not support the file formats. | See Supported file formats on page 78 for more information about file formats supported by the projector. |

| Problem | Cause | Remedy |
|-------------------------------|--|--|
| Screen brightness is changed. | The adapter is removed. | The light brightness is decreased in Eco and Low power consumption to support longer projection. If a brighter screen is preferred, connect the power adapter to the projector and change the Power Mode to Normal . |
| | The adapter is not removed but the Power Mode is switched to Eco or Low power consumption . | |
| No input source. | The video source is not turned on or connected correctly. | Turn the video source on and check that the signal cable is connected correctly. |
| | The projector is not correctly connected to the input source device. | Check the connection. |
| | The video or audio file format is not supported by the projector. | Make sure the supported file format as described in Supported file formats on page 78 is being played, or contact the customer service for assistance. |
| Image or audio is unstable. | The connection cables are not securely connected to the projector or the signal source. | Correctly connect the cables to the appropriate terminals. |
| | The Internet bandwidth is limited or over-occupied. | Connect to another wireless AP or to an Internet channel of better speed. |
| | The projector is out of effective range of Bluetooth connection. | Make sure the projector is within the effective range of Bluetooth connection. Make sure there is as less radio frequency interference as possible when using a 2.4G network. |
| Picture is blurred. | The projection lens is not correctly focused. | Adjust the focus of the lens using focus knob on the projector. |
| | The projector and the screen are not aligned properly. | Adjust the projection angle and direction as well as the height of this projector if necessary. |

| Problem | Cause | Remedy |
|---|---|---|
| Remote control does not work correctly. | The batteries are out of power. | Replace both of the batteries with new ones. |
| | There is an obstacle between the remote control and the projector. | Remove the obstacle. |
| | You are too far away from the projector. | Stand within 8 meters (26.2 feet) of the projector. |
| The projector cannot connect to the desired SSID. | The handshaking between the projector and the router does not follow IEEE 802.11 protocols. | <ul style="list-style-type: none"> • For 2.4G frequency, make sure the wireless mode of the router is configured as 802.11g/n or 802.11n. • For 5G frequency, make sure the wireless mode of the router is configured as 802.11n. |

Specifications

Projector specifications



All specifications are subject to change without notice.

| Specifications | |
|--|--------------------------------------|
| Projection System | DLP |
| DMD Type | 0.20" |
| Native Resolution | 854 x 480 pixels |
| Brightness | 200 ANSI Lumens |
| Contrast Ratio | 100,000:1 |
| Display Color | 24 Bits (16.7 million colors) |
| Aspect Ratio | 16:9 |
| Light Source | LED |
| Light Source Life⁽¹⁾ | 20,000 hours (Normal) |
| Throw Ratio | 1.3 (35"@1M) |
| Zoom Ratio | Fixed |
| Keystone Correction | 1D, (Auto) Vertical \pm 40 degrees |
| Projection Offset (Full-Height) | 100% \pm 5% |
| Projection Size | 30 to 100 inches |

| Specifications | | |
|-----------------------------|--|---|
| Interface | <ul style="list-style-type: none"> • USB-A (USB 2.0)(5V/1.A) x 1 • HDMI (1.4b/HDCP1.4) x 1 • HDMI (1.4b/HDCP1.4, internal) x 1, for QS01 HDMI Media Streaming Dongle • 3.5mm Audio Out x 1 | |
| Power | DC Supply | |
| | Frequency | 100-240V~, 50/60Hz, 0.8A; Output: 12Vdc, 2.5A (Adapter Supply) |
| | Maximum power Consumption (Normal) | 27.84W (charging) |
| | Battery | |
| | Type | Lithium-ion battery |
| | Capacity | 7.4V 3000.0mAh 22.2W |
| | Battery Life Cycle | 300 cycles |
| | Battery Life (Low power consumption) | <ul style="list-style-type: none"> • Video playtime: approximate 160 minutes • Music playtime: approximate 240 minutes  Battery life may vary by the playing content, the media source, or the projector settings. |
| Built-in Speaker | 5W speaker | |
| Resolution Support | HDMI: up to 1080/60p | |
| Horizontal Frequency | 15 to 102 KHz | |
| Vertical Scan Rate | 23 to 120Hz | |

Specifications

| | |
|---|---|
| Noise Level (Normal/Eco/Low power consumption) | 25dBA/25dBA/23dBA |
| HDTV Compatibility | 720@50P/60P, 1080@50i/60i/24p/25p/30p/50p/60p |
| Operating Temperature | 0 to 40 ° C |
| Storage Temperature | -20 to 60 ° C (without condensation) |
| Operating / Storage Relative Humidity | 10% to 90% (without condensation) |



- LED life results will vary depending on environmental conditions and usage.
- The performance of WLAN and Bluetooth might be disturbed by distance and obstacles.

Timing chart

Supported timing for video input

| Timing | Resolution | H. Frequency (KHz) | V. Frequency (Hz) | Dot Clock Frequency (MHz) |
|----------|-----------------|--------------------|-------------------|---------------------------|
| 480i | 720(1440) × 480 | 15.73 | 59.94 | 27 |
| 480p | 720 × 480 | 31.47 | 59.94 | 27 |
| 576i | 720(1440) × 576 | 15.63 | 50 | 27 |
| 576p | 720 × 576 | 31.25 | 50 | 27 |
| 720/50p | 1280 × 720 | 37.5 | 50 | 74.25 |
| 720/60p | 1280 × 720 | 45 | 60 | 74.25 |
| 1080/24P | 1920 × 1080 | 27 | 24 | 74.25 |
| 1080/25P | 1920 × 1080 | 28.13 | 25 | 74.25 |
| 1080/30P | 1920 × 1080 | 33.75 | 30 | 74.25 |
| 1080/50i | 1920 × 1080 | 28.13 | 50 | 74.25 |
| 1080/60i | 1920 × 1080 | 33.75 | 60 | 74.25 |
| 1080/50P | 1920 × 1080 | 56.25 | 50 | 148.5 |
| 1080/60P | 1920 × 1080 | 67.5 | 60 | 148.5 |



Supported by HDMI 1.4b only.

Supported timing for PC input

| Resolution | Mode | Refresh Rate (Hz) | H. Frequency (KHz) | Dot Clock Frequency (MHz) |
|------------|---------------|-------------------|--------------------|---------------------------|
| 640 x 480 | VGA_60 | 59.94 | 31.469 | 25.175 |
| | VGA_72 | 72.809 | 37.861 | 31.5 |
| | VGA_75 | 75 | 37.5 | 31.5 |
| | VGA_85 | 85.008 | 43.269 | 36 |
| 720 x 400 | 720x400_70 | 70.087 | 31.469 | 28.3221 |
| 800 x 600 | SVGA_60 | 60.317 | 37.879 | 40 |
| | SVGA_72 | 72.188 | 48.077 | 50 |
| | SVGA_75 | 75 | 46.875 | 49.5 |
| | SVGA_85 | 85.061 | 53.674 | 56.25 |
| 1024 x 768 | XGA_60 | 60.004 | 48.363 | 65 |
| | XGA_70 | 70.069 | 56.476 | 75 |
| | XGA_75 | 75.029 | 60.023 | 78.75 |
| | XGA_85 | 84.997 | 68.667 | 94.5 |
| 1152 x 864 | 1152 x 864_75 | 75 | 67.5 | 108 |
| 1280x720 | 1280 x 720_60 | 60 | 45 | 74.25 |
| 1280 x 768 | 1280 x 768_60 | 59.87 | 47.776 | 79.5 |
| 1280 x 800 | WXGA_60 | 59.81 | 49.702 | 83.5 |
| | WXGA_75 | 74.934 | 62.795 | 106.5 |
| | WXGA_85 | 84.88 | 71.554 | 122.5 |

| Resolution | Mode | Refresh Rate (Hz) | H. Frequency (KHz) | Dot Clock Frequency (MHz) |
|-----------------------------------|---------------------------|-------------------|--------------------|---------------------------|
| 1280 x 1024 | SXGA_60 | 60.02 | 63.981 | 108 |
| | SXGA_75 | 75.025 | 79.976 | 135 |
| | SXGA_85 | 85.024 | 91.146 | 157.5 |
| 1280 x 960 | 1280 x 960_60 | 60 | 60 | 108 |
| | 1280 x 960_85 | 85.002 | 85.938 | 148.5 |
| 1360 x 768 | 1360 x 768_60 | 60.015 | 47.712 | 85.5 |
| 1440 x 900 | WXGA+_60 | 59.887 | 55.935 | 106.5 |
| 1400x1050 | SXGA+_60 | 59.978 | 65.317 | 121.75 |
| 1600x1200 | UXGA | 60 | 75 | 162 |
| 1680x1050 | 1680x1050_60 | 59.954 | 65.29 | 146.25 |
| 640 x 480@67Hz (HDMI portonly) | MAC13 | 66.667 | 35 | 30.24 |
| 832 x 624@75Hz (HDMI portonly) | MAC16 | 74.546 | 49.722 | 57.28 |
| 1024 x 768@75 Hz | MAC19 | 75.02 | 60.241 | 80 |
| 1152 x 870@75 Hz | MAC21 | 75.02 | 68.68 | 100 |
| 1920 x 1080 @60HZ | 1920X1080_60 (CEA-861) | 60 | 67.5 | 148.5 |

 The timings showing above may not be supported for due to EDID file and VGA graphic card limitations. It is possible that some timings cannot be chosen.

Supported file formats

| File type | File extension |
|-----------|---|
| Documents | N/A |
| Photos | JPG(.jpg, .jpeg), PNG(.png), BMP(.bmp) |
| Music | MP3(.mp3), WAV(.wav), WMA(.wma), FLAC(.flac), AAC(.aac), OGG(.ogg) |
| Video | MPEG program stream (.mpg, .mpeg) MPEG transport stream (.ts, .trp, .tp) ASF(.asf) WMV(.wmv) AVI(.avi) MKV(.mkv) |
| Subtitles | N/A |



Bit rate range: If the peak bit rate of a video file is larger than 10MB, it might cause video playback lag.

Appendix

Installing the projector on a tripod (purchased separately)

Use a tripod plate to mount the projector onto a tripod:

1. Install the tripod's quick release plate to the projector's tripod screw hole and tighten the plate's screw.

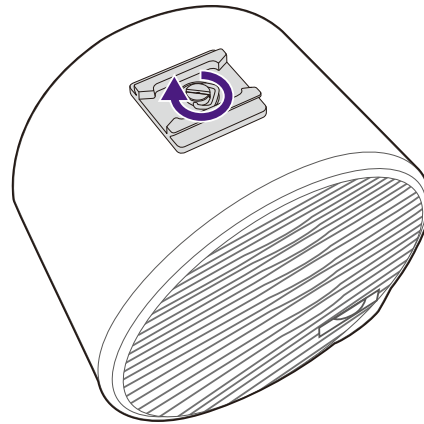

2. Install the projector onto the tripod.

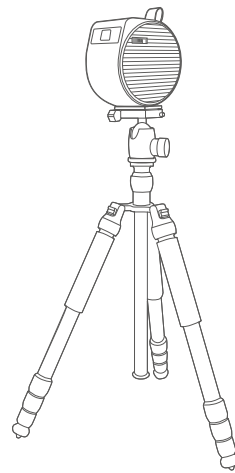

Copyright and disclaimer

Copyright

Copyright © 2022 by BenQ Corporation. All rights reserved. No part of this publication may be reproduced, transmitted, transcribed, stored in a retrieval system or translated into any language or computer language, in any form or by any means, electronic, mechanical, magnetic, optical, chemical, manual or otherwise, without the prior written permission of BenQ Corporation.

All other logos, products, or company names mentioned in this manual may be the registered trademarks or copyrights of their respective companies, and are used for informational purposes only.

Android™ is a trademark of Google LLC.

The Bluetooth® word mark and logos are registered trademarks owned by Bluetooth SIG, Inc. and any use of such marks by BenQ Corporation is under license.

iOS is a trademark or registered trademark of Cisco in the U.S. and other countries and is used under license.

macOS® is a trademark of Apple Inc., registered in the U.S. and other countries.

Disclaimer

BenQ Corporation makes no representations or warranties, either expressed or implied, with respect to the contents hereof and specifically disclaims any warranties, merchantability or fitness for any particular purpose. Further, BenQ Corporation reserves the right to revise this publication and to make changes from time to time in the contents hereof without obligation of BenQ Corporation to notify any person of such revision or changes. This user manual aims to provide the most updated and accurate information to customers, and thus all contents may be modified from time to time without prior notice. Please visit [Support.BenQ.com](https://support.benq.com) for the latest version of this manual.

Warranty

BenQ warrants this product against any defects in material and workmanship, under normal usage and storage.

Proof of purchase date will be required with any warranty claim. In the event this product is found to be defective within the warranty period, BenQ's only obligation and your exclusive remedy shall be replacement of any defective parts (labor included). To obtain warranty service, immediately notify the dealer from which you purchased the product of any defects.

Important: The above warranty shall be void if the customer fails to operate the product in accordance with BenQ's written instructions, especially the ambient humidity must be in-between 10% and 90%, temperature in-between 0°C and 40°C, altitude lower than 2000 meters, and avoiding to operate the projector in a dusty environment. This warranty gives you specific legal rights, and you may have other rights which vary from country to country.

For other information, please visit www.BenQ.com.

Statement regarding hyperlinks and third-party websites

BenQ is not responsible for the content of the websites or of similar resources, which are maintained and controlled by third parties, that may be linked from this product. Providing links to those websites or to similar resources does not mean that BenQ makes any warranty or representation to their content by expression or by implication.

Any third party content or service preinstalled in this product is provided "as is". BenQ does not, by expression or by implication, make any warrant to the content or to the services provided by third parties. BenQ does not warrant or guarantee that the content or services provided by third parties are accurate, effective, most up-to-date, legal, or complete. Under no circumstances shall BenQ be liable for the content or services provided by third parties including their negligence.

Services provided by third parties may be terminated temporarily or permanently. BenQ does not warrant or guarantee that any content or services provided by third parties are in good condition at any time, and is not liable for the termination of the said content and services.

In addition, BenQ is not involved in any transactions you conduct in the websites or similar resources maintained by third parties.

You should contact the content or service providers for any questions, concerns, or disputes.