

**Jabra**<sup>®</sup>  
YOU'RE ON

# JABRA PRO 935

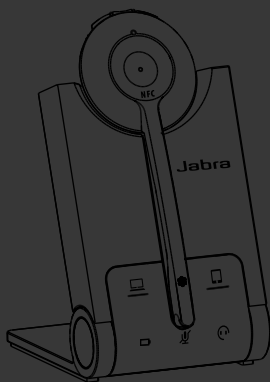

User Manual

[jabra.com/pro935](http://jabra.com/pro935)

A BRAND BY

**GN Netcom**

---

© 2015 GN Netcom A/S. All rights reserved. Jabra® is a registered trademark of GN Netcom A/S. All other trademarks included herein are the property of their respective owners. The Bluetooth® word mark and logos are owned by the Bluetooth SIG, Inc. and any use of such marks by GN Netcom A/S is under license. (Design and specifications subject to change without notice).

---

MADE IN CHINA

MODEL WHB005HS/  
WHB005BSU



**Bluetooth®**

---

**Declaration of Conformity** can be found on  
[www.jabra.com/CP/US/declarations-of-conformity](http://www.jabra.com/CP/US/declarations-of-conformity)

1. WELCOME .....	4
2. PRODUCT OVERVIEW .....	5
3. CHARGE THE HEADSET .....	8
4. HOW TO WEAR .....	10
5. HOW TO CONNECT.....	12
6. HOW TO USE .....	16
7. VOICE GUIDANCE .....	18
8. BASE LED INDICATOR .....	19
9. SOFTWARE .....	21
10. ADVANCED SETTINGS.....	22
11. SUPPORT .....	25
12. TECHNICAL SPECIFICATIONS .....	26

# 1. WELCOME

Thank you for using the Jabra PRO 935. We hope you will enjoy it!

## **JABRA PRO 935 FEATURES**

- Plug and play simplicity
- Wireless freedom - up to 100m/300ft from base
- 12 hours talk-time
- NFC technology - one touch pairing

## 2. PRODUCT OVERVIEW

### 2.1 HEADSET

---

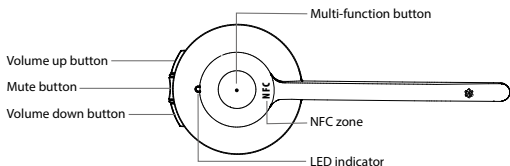

### 2.2 BASE

---

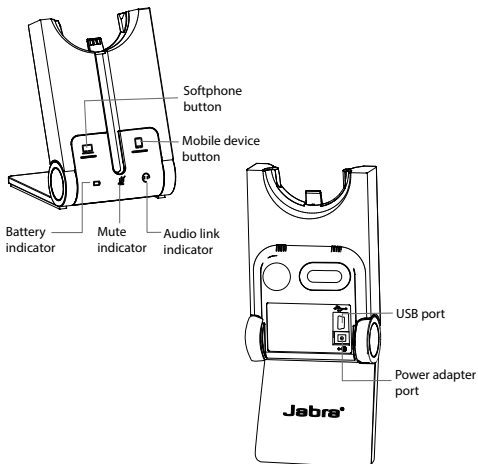

## FOLDABLE BASE STAND

The Jabra PRO 935 base stand can be folded into three positions: open, closed and standing.

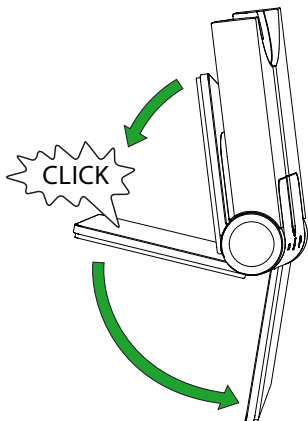

## 2.3 OPTIONAL ACCESSORIES

---

The following Jabra PRO accessories are available separately. Visit [jabra.com](http://jabra.com) for a full accessory overview.

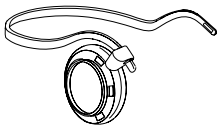

Neckband attachment

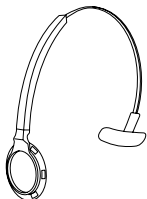

Replacement headband attachment

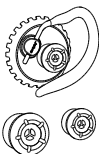

Replacement earhook, with earbuds



Replacement ear cushions



AC power cable



Charging cable

### 3. CHARGE THE HEADSET

The headset will charge when docked in the base, and the base is connected to a power supply.

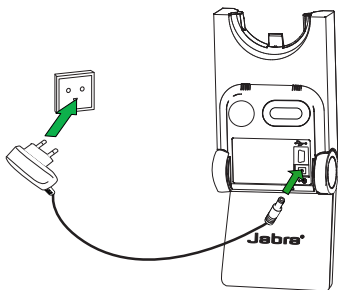





It takes approx. 3 hours to charge the headset.



## 3.1 HEADSET BATTERY STATUS

---

WHAT YOU SEE	BATTERY LEVEL
	High
	Medium
	Low
	Very low
	Battery charging

---

## 4. HOW TO WEAR

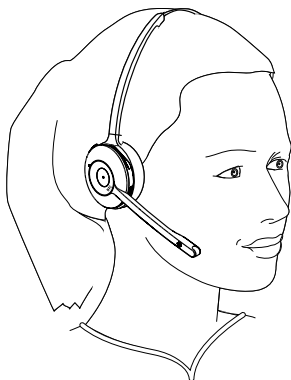

The Jabra PRO 935 headset can be worn in three different wearing-styles:

- Headband
- Earhook (optional accessory)
- Neckband (optional accessory)

All wearing-styles can be worn on either the left or right ear.

**NOTE:** It is important to position the microphone close to the mouth for maximum noise cancellation.

## 4.1 HEADBAND

---

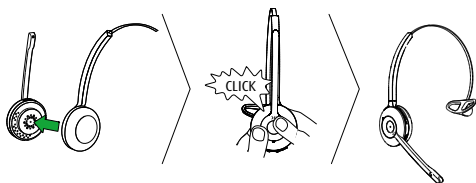

## 4.2 EARHOOK (OPTIONAL ACCESSORY)

---

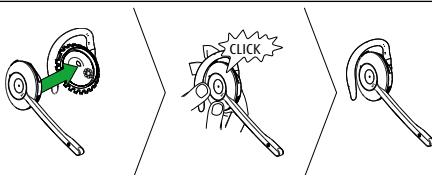

## 4.3 NECKBAND (OPTIONAL ACCESSORY)

---



**NOTE:** The neckband or earhook can be purchased on [jabra.com](http://jabra.com)

# 5. HOW TO CONNECT

## 5.1 CONNECT TO PC (SOFTPHONE)

---

1. Plug the base into a power supply using the supplied wall charger.
2. Connect the base to your PC using the supplied USB cable. The PC icon on the base will light up.
3. Dock the headset in the base.

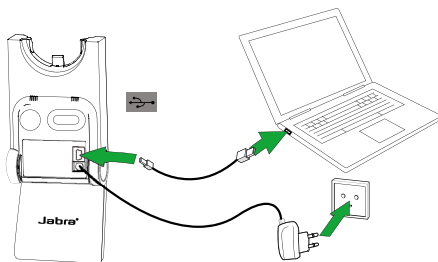

## 5.2 CONNECT TO MOBILE DEVICE

---

1. Connect the base to a power supply.
2. Press the Mobile device button on the base.
3. Pairing mode will be announced in the headset and the mobile device icon will light up.
4. Follow the voice-guided pairing instructions in the headset to pair to your Bluetooth device.

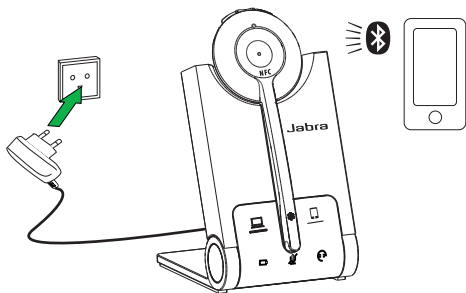

## 5.3 CONNECT TO MOBILE DEVICE (NFC)

---

NFC is a faster, simpler way to connect two Bluetooth devices.

1. Ensure NFC is enabled on the mobile device.
2. Tap the NFC zone on the mobile device against the NFC zone on the headset.

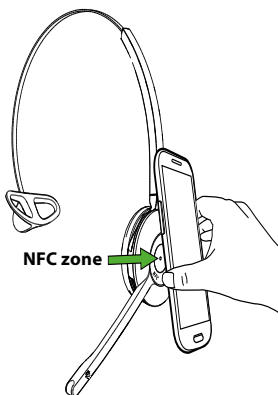

## 5.4 CONNECT TO MOBILE DEVICE (WITHOUT BASE)

---

It is possible to connect the headset directly to a mobile device.

1. Ensure the headset is turned off.
2. Press and hold (5 seconds) the Multi-function button to turn the headset on and enter pairing mode.
3. Follow the voice-guided pairing instructions in the headset to pair to your mobile device.

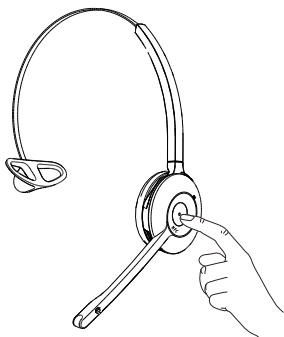

## 6. HOW TO USE

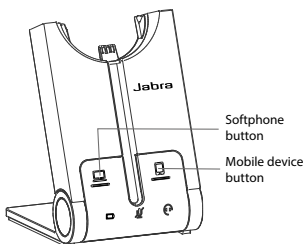
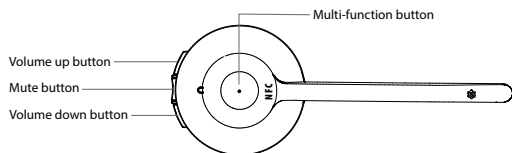

FUNCTION	ACTION
Headset on/off	Press (1 sec) the <b>Multi-function</b> button to turn on. Press (3 secs) to turn off
Answer/end call	Tap the <b>Multi-function</b> button
 Reject call	Double-tap the <b>Multi-function</b> button
Initiate call (Softphone)	Tap the <b>Multi-function</b> button when not on a call
Voice dial (mobile device)	Press (1 sec) the <b>Multi-function</b> button when not on a call





Adjust speaker volume

Tap the **Volume up** or **Volume down** button



Mute/un-mute

Tap the **Mute** button



Initiate or answer call on selected device

Tap the **Softphone** button or **Mobile device** button on the base

## 6.1 MULTIPLE CALL HANDLING

The headset can accept and handle multiple calls.

	CALL FUNCTION	HOW TO DO IT
	End current call and answer incoming call	Tap the <b>Multi-function</b> button
	Switch between held call and active call	Press and hold (2 secs) the <b>Multi-function</b> button
	Put current call on hold and answer incoming call	Press and hold (2 secs) the <b>Multi-function</b> button
	Reject incoming call, and continue active call	Double-tap the <b>Multi-function</b> button
	Put current call on hold, and answer incoming call	Tap the <b>Softphone</b> button or <b>Mobile device</b> button on the base

## 7. VOICE GUIDANCE

The headset plays a variety of voice announcements to indicate status and connection guidance.



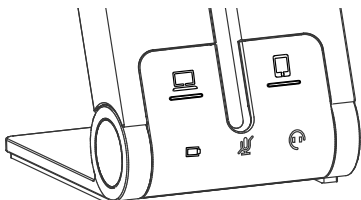

LISTEN	WHAT YOU HEAR
	Go to the Bluetooth menu on your mobile device and connect to Jabra PRO
	Power on
	Power off
	Low battery
	Mobile connected
	Mobile disconnected
	PC connected
	PC disconnected
	Mute on
	Mute off

## 8. BASE LED INDICATORS

The Jabra PRO 935 base has five LEDs to indicate battery, call status and events.



LED	EVENT
	Incoming call
	On call
	Call on hold
	Attempting to connect
	Battery charging (slow flash)
	Full battery
	Low battery
	Very low battery (fast flash)

LED	EVENT
	Sleep mode (slow flash)
	Unknown battery status
	Microphone muted
	Active audio link between headset and base
	Searching for headset

# 9. SOFTWARE

## 9.1 JABRA DIRECT

---

Jabra Direct is software designed to support, manage and enable optimal functionality for Jabra devices.

**Download the latest version - [jabra.com/direct](https://jabra.com/direct)**

It is highly recommended to install Jabra Direct.

## 9.2 UPDATE FIRMWARE

---

Updating firmware improves performance or adds new functionality to your Jabra PRO 935.

To update firmware:

1. Connect to a PC using the USB cable.
2. Download and install Jabra Direct.
3. Check for the latest firmware via Jabra Direct.  
You will receive notifications whenever there is an update for your device.

# 10. ADVANCED SETTINGS

Five advanced settings can be configured using the headset

- Mute reminder tone
- Base ringtone
- Base ringtone volume
- Intellitone
- Wireless range









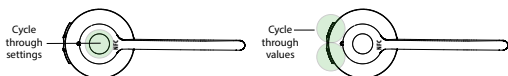





## 10.1 CHANGE THE ADVANCED SETTINGS

---





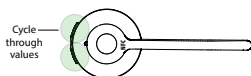
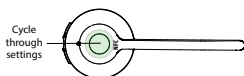

1. Wear the headset, and simultaneously press and hold (5 secs) the volume buttons on the headset until you hear 'setup', and then release the buttons.
2. Tap the Multi-function button to cycle through the settings (see table below). Each setting will be announced in the headset. To change a setting, use the volume buttons to cycle through the setting values, and tap the Multi-function button to select the value.
3. When finished, simultaneously press and hold (5 secs) the volume buttons until you hear 'goodbye', then release the buttons. The base will reset and update the settings.

## 10.2 LIST OF ADVANCED SETTINGS



SETTING LIGHT	SETTING	VALUE LIGHT	VALUE
 x1	Mute reminder tone		On
			Off
 x2	Base ringtone		Ringtone 1
			Ringtone 2
			Ringtone 3
			Ringtone 4
			Ringtone 5
			High
 x3	Base ringtone volume		Medium
			Low
			Off



SETTING LIGHT	SETTING	VALUE LIGHT	VALUE
 x5	Intellitone		Peakstop
			Peakstop and Intellitone
 x6	Wireless range		Normal range
			Low range
			Very low range



# 11. SUPPORT

## 11.1 FAQ

---

View the full FAQ on [Jabra.com/pro935](https://www.jabra.com/pro935).

## 11.2 HOW TO CARE FOR YOUR JABRA DEVICE

---

- Always store the headset with the power off.
- Avoid storage at extreme temperatures (below -20°C/-4°F or above 45°C/113°F). This can shorten battery life and may affect speaker operation.
- Do not expose the headset or base to rain or other liquids.

# 12. TECHNICAL SPECIFICATIONS

JABRA PRO 935	SPECIFICATION
Weight:	Headset: 28g Base: 162g
Dimensions:	Headset: H 131mm x W 50mm x 18mm Base: H 118mm x W 76mm x L 29mm
Microphones:	Noise reduction microphone
Speakers:	Wideband speaker
Operating range:	Up to 100m/300ft (class 1)
Bluetooth version:	4.0
Paired devices:	Up to 8 paired devices, Two active device connected at a time
Supported Bluetooth profiles:	Hands Free Profile (v1.6), Headset profile(v1.2)
Talk time:	Up to 12 hours
Standby time:	Up to 7 days
Operating temperature:	-0°C to 40°C (32°F to 104°F)
Storage temperature:	-20°C to 45°C (-4°F to 113°F)
Pairing passkey or PIN:	0000

