

Adjustable Desktop Monitor Stand with Cable Hook

ARMPIVSTND



*actual product may vary from photos

DE: Bedienungsanleitung - de.startech.com

FR: Guide de l'utilisateur - fr.startech.com

ES: Guía del usuario - es.startech.com

IT: Guida per l'uso - it.startech.com

NL: Gebruiksaanwijzing - nl.startech.com

PT: Guia do usuário - pt.startech.com

For the most up-to-date information, please visit: www.startech.com

FCC Compliance Statement

This equipment has been tested and found to comply with the limits for a Class B digital device, pursuant to part 15 of the FCC Rules. These limits are designed to provide reasonable protection against harmful interference in a residential installation. This equipment generates, uses and can radiate radio frequency energy and, if not installed and used in accordance with the instructions, may cause harmful interference to radio communications. However, there is no guarantee that interference will not occur in a particular installation. If this equipment does cause harmful interference to radio or television reception, which can be determined by turning the equipment off and on, the user is encouraged to try to correct the interference by one or more of the following measures:

- Reorient or relocate the receiving antenna.
- Increase the separation between the equipment and receiver.
- Connect the equipment into an outlet on a circuit different from that to which the receiver is connected.
- Consult the dealer or an experienced radio/TV technician for help.

Use of Trademarks, Registered Trademarks, and other Protected Names and Symbols

This manual may make reference to trademarks, registered trademarks, and other protected names and/or symbols of third-party companies not related in any way to StarTech.com. Where they occur these references are for illustrative purposes only and do not represent an endorsement of a product or service by StarTech.com, or an endorsement of the product(s) to which this manual applies by the third-party company in question. Regardless of any direct acknowledgement elsewhere in the body of this document, StarTech.com hereby acknowledges that all trademarks, registered trademarks, service marks, and other protected names and/or symbols contained in this manual and related documents are the property of their respective holders.



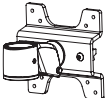

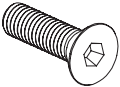

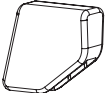







Table of Contents

Introduction	1
Packaging Contents	1
Product Overview	2
Installation	2
Stand Assembly	2
Standard LCD / LED Monitor Mounting	4
iMac / Apple Cinema Display Mounting	5
Adjusting Monitor Mount Resistance	9
Specifications	10
Technical Support	11
Warranty Information	11

Introduction

Packaging Contents

- 1 x Instruction Manual

<p>1</p>  <p>Aluminum Base Qty: 1</p>	<p>2</p>  <p>Support Post Qty: 1</p>	<p>3</p>  <p>Monitor Mount Qty: 1</p>
<p>4</p>  <p>Cable Clip Qty: 1</p>	<p>5</p>  <p>Iron Position Ring Qty: 1</p>	<p>6</p>  <p>M5x18mm Hex Screws Qty: 4</p>
<p>7</p>  <p>Flange Qty: 1</p>	<p>8</p>  <p>Plastic Caps Qty: 4</p>	<p>9</p>  <p>Access Card Qty: 1</p>
<p>10</p>  <p>3mm Allen Wrench Qty: 1</p>	<p>11</p>  <p>4mm Allen Wrench Qty: 1</p>	<p>12</p>  <p>Torx Tool Qty: 1</p>
<p>13</p>  <p>Thumb Screws Qty: 4</p>	<p>14</p>  <p>M6x16mm Screws Qty: 2</p>	<p>15</p>  <p>Rubber Feet Qty: 4</p>

Product Overview

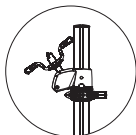
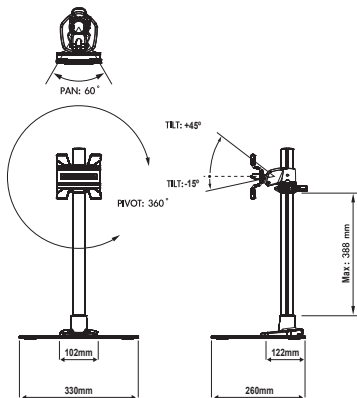

Note: The size and type of monitor mounted may restrict tilt motion



Installation

Stand Assembly

1. Attach the Aluminum Base (1) and Support Post (2) using 4 M5x18mm Hex Screws (6) and the 3mm Allen Wrench (10).

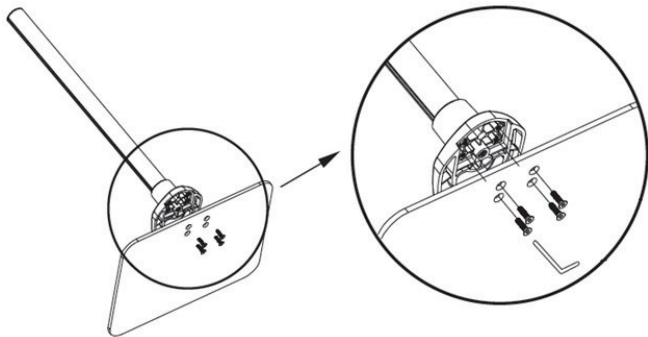

2. Attach the Rubber Feet (15) to the Base (1).

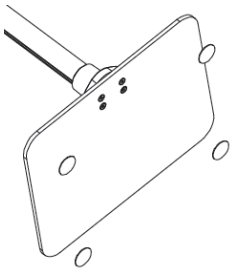

3. Slide the Cable Clip (4) onto the Support Post (2) to your desired height. Hand-tighten the set screw and then close the quick-release clamp to lock into place.

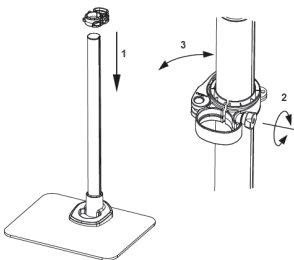

4. Slide the Iron Position Ring (5) onto the Cable Clip (4), with the flanges facing upward.

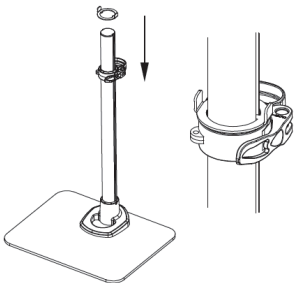

Warning: Ensure the Iron Position Ring is installed, and that the monitor is slid onto the Support post facing forward (over the base). The Iron Position Ring limits the ability to swivel the monitor around too far, causing the center of gravity to shift and possibly fall over.

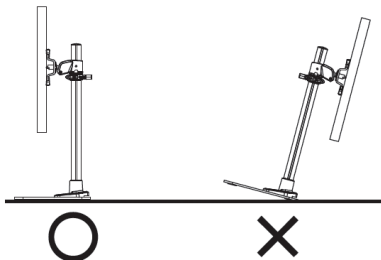

Standard LCD / LED Monitor Mounting

1. Carefully place your display face down on a protective surface to access the mounting points.

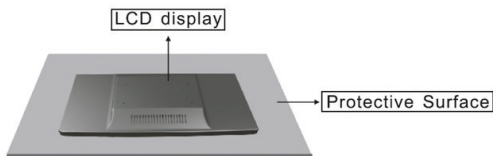

2. Attach the display to the Monitor Mount (3) using the 4 Thumb Screws (13).

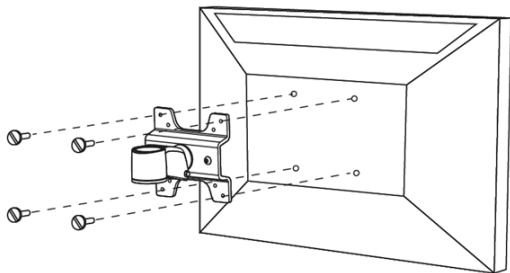

Warning: Do not over-tighten the screws and stop immediately if you encounter resistance to avoid damage to your display. Ensure that all screws being used are the same length and thread type.

- Slide the Monitor Mount (3) onto the Support Post (2) until it rests on the Iron Position Ring (5) and tighten the set screw using the M3 Allen Wrench (15).

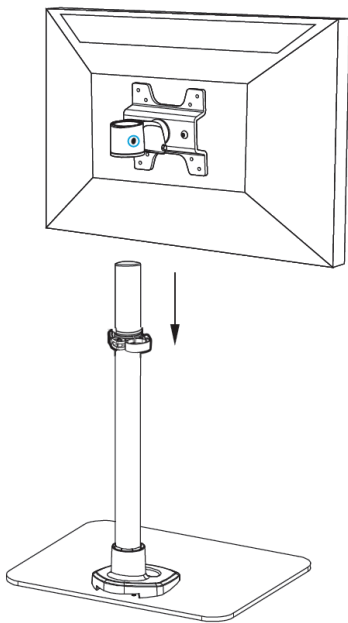

iMac / Apple Cinema Display Mounting

- Power off your iMac / Apple Cinema display and disconnect all cables.
- Turn the display so the back is facing you, and tilt the display all the way forward.
- Insert the Access Card (9) into the space directly above the stand to release the latch.

Note: The access card should go into the space approx. $\frac{3}{4}$ " at a slight upward angle. If it goes in further, you have missed the latch.

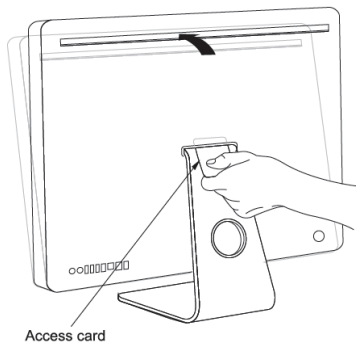

4. Once the latch is released, tilt the display forward another 10° to expose the 8 screws on top of the stand. The stand should lock into place.
5. When the stand is locked, hold the sides of the display and carefully place it face-down on a protective surface, with the stand hanging over the edge of your work surface.

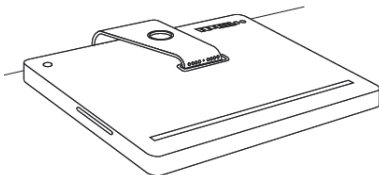

6. Using the Torx Tool (12), remove the 8 screws that attach the stand to the back of your iMac and remove the stand.

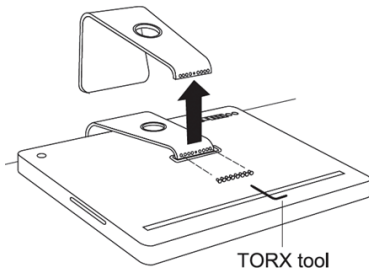

7. Align the hole in the Flange (7) with the pin on the back of your iMac, then use the Torx Tool (12) and the screws removed in the previous step to attach the Flange.

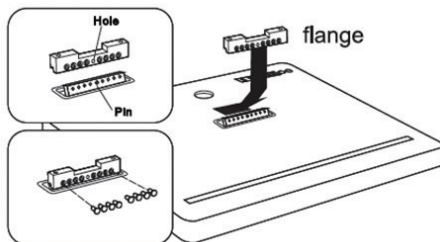

8. Place the 4 Plastic Caps (8) onto the ends of the Monitor Mount (3).

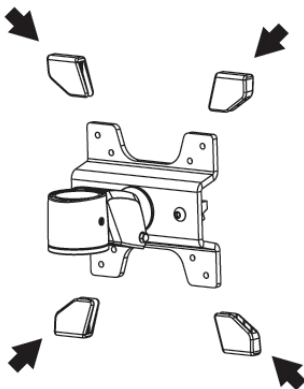

9. Place the Monitor Mount (3) over the Flange (8) and attach using the 2 M6x16mm Screws (5) and the 4mm Allen Wrench (11).

Note: Keep the Flange in the locked position while you attach the Monitor Mount.

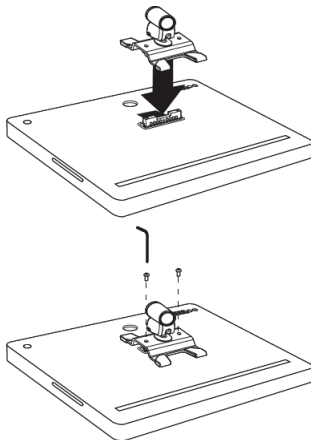

10. Slide the Monitor Mount (3) onto the Support Post (2) until it rests on the Iron Position Ring (5) and tighten the set screw using the M3 Allen Wrench (15).

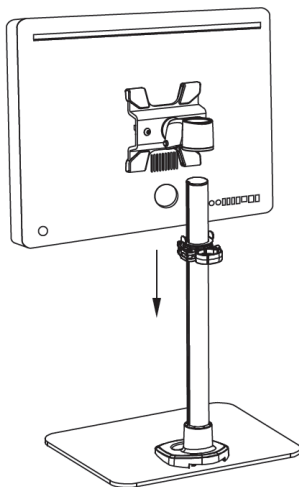

Adjusting Monitor Mount Resistance

Warning: Forced movement of the Mount Bracket without loosening the screws may damage the product or the mounted displays.

Always support your display from underneath when making any adjustments to the height, or the Mount Bracket to avoid damage to the display.

Note: For all adjustments outlined below, turning the screw clockwise will increase the resistance, while turning the screw counter-clockwise will decrease resistance.

To increase / decrease the tilt resistance, adjust the set screw located on the side of the Monitor Mount joint, using the 3mm Allen Wrench **(10)**.

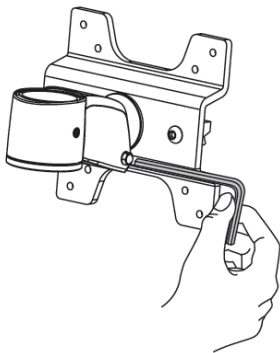

To increase / decrease swivel resistance, adjust the set screw located on the side of the Monitor Mount bracket at the Support Post, using the 3mm Allen Wrench **(10)**.

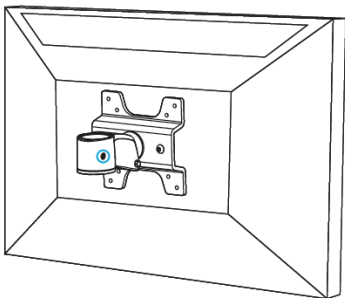

Specifications

Weight Capacity

30.9 lbs (14 kg)

Max Display Size

30"

VESA Compatibility

75x75 mm and 100x100 mm

Technical Support

StarTech.com's lifetime technical support is an integral part of our commitment to provide industry-leading solutions. If you ever need help with your product, visit www.startech.com/support and access our comprehensive selection of online tools, documentation, and downloads.

For the latest drivers/software, please visit www.startech.com/downloads

Warranty Information

This product is backed by a ten-year warranty.

In addition, StarTech.com warrants its products against defects in materials and workmanship for the periods noted, following the initial date of purchase. During this period, the products may be returned for repair, or replacement with equivalent products at our discretion. The warranty covers parts and labor costs only. StarTech.com does not warrant its products from defects or damages arising from misuse, abuse, alteration, or normal wear and tear.

Limitation of Liability

In no event shall the liability of StarTech.com Ltd. and StarTech.com USA LLP (or their officers, directors, employees or agents) for any damages (whether direct or indirect, special, punitive, incidental, consequential, or otherwise), loss of profits, loss of business, or any pecuniary loss, arising out of or related to the use of the product exceed the actual price paid for the product. Some states do not allow the exclusion or limitation of incidental or consequential damages. If such laws apply, the limitations or exclusions contained in this statement may not apply to you.

Hard-to-find made easy. At StarTech.com, that isn't a slogan. It's a promise.

StarTech.com is your one-stop source for every connectivity part you need. From the latest technology to legacy products — and all the parts that bridge the old and new — we can help you find the parts that connect your solutions.

We make it easy to locate the parts, and we quickly deliver them wherever they need to go. Just talk to one of our tech advisors or visit our website. You'll be connected to the products you need in no time.

Visit www.startech.com for complete information on all StarTech.com products and to access exclusive resources and time-saving tools.

StarTech.com is an ISO 9001 Registered manufacturer of connectivity and technology parts. StarTech.com was founded in 1985 and has operations in the United States, Canada, the United Kingdom and Taiwan servicing a worldwide market.