

# **AVerVision F17-8M**

## **User Manual**



## **Federal Communications Commission Statement(Class A)**



**NOTE-** This equipment has been tested and found to comply with the limits for a Class A digital device, pursuant to Part 15 of the FCC Rules. These limits are designed to provide reasonable protection against harmful interference in a residential installation.

This equipment generates uses and can radiate radio frequency energy and, if not installed and used in accordance with the instructions, may cause harmful interference to radio communications. However, there is no guarantee that interference will not occur in a particular installation. If this equipment does cause harmful interference to radio or television reception, which can be determined by tuning the equipment off and on, the user is encouraged to try to correct the interference by one or more of the following measures:

- Reorient or relocate the receiving antenna.
- Increase the separation between the equipment and receiver.
- Connect the equipment into an outlet on a circuit different from that to which the receiver is connected.
- Consult the dealer or an experienced radio/television technician for help.

### **Class A ITE:**

Class A ITE is a category of all other ITE which satisfies the class A ITE limits but not the class B ITE limits. Such equipment should not be restricted in its sale but the following warning shall be included in the instructions for use:

Warning - This is a class A product. In a domestic environment this product may cause radio interference in which case the user may be required to take adequate measures.

### **CE Class A (EMC)**



This product is herewith confirmed to comply with the requirements set out in the Council Directives on the Approximation of the laws of the Member States relating to Electromagnetic Compatibility Directive 2014/30/EU.

Warning - This is a Class A product. In a domestic environment this product may cause radio interference in which case the user may be required to take adequate measures to correct this interference.

### **DISCLAIMER**

No warranty or representation, either expressed or implied, is made with respect to the contents of this documentation, its quality, performance, merchantability, or fitness for a particular purpose. Information presented in this documentation has been carefully checked for reliability; however, no responsibility is assumed for inaccuracies. The information contained in this documentation is subject to change without notice.

In no event will AVer be liable for direct, indirect, special, incidental, or consequential damages arising out of the use or inability to use this product or documentation, even if advised of the possibility of such damages.

### **TRADEMARKS**

“AVer” is a trademark owned by AVer Information Inc. Other trademarks used herein for description purpose only belong to each of their companies.

### **COPYRIGHT**

©2017 AVer Information Inc. All rights reserved.

All rights of this object belong to AVer Information Inc. Reproduced or transmitted in any form or by any means without the prior written permission of AVer Information Inc. is prohibited. All information or specifications are subject to change without prior notice.

### **NOTICE**

SPECIFICATIONS ARE SUBJECT TO CHANGE WITHOUT PRIOR NOTICE. THE INFORMATION CONTAINED HEREIN IS TO BE CONSIDERED FOR REFERENCE ONLY.

## **WARNING**

TO REDUCE RISK OF FIRE OR ELECTRIC SHOCK, DO NOT EXPOSE THIS APPLIANCE TO RAIN OR MOISTURE. WARRANTY VOID FOR ANY UNAUTHORIZED PRODUCT MODIFICATION.



THE MARK OF CROSSED-OUT WHEELED BIN INDICATES THAT THIS PRODUCT MUST NOT BE DISPOSED OF WITH YOUR OTHER HOUSEHOLD WASTE. INSTEAD, YOU NEED TO DISPOSE OF THE WASTE EQUIPMENT BY HANDING IT OVER TO A DESIGNATED COLLECTION POINT FOR THE RECYCLING OF WASTE ELECTRICAL AND ELECTRONIC EQUIPMENT. FOR MORE INFORMATION ABOUT WHERE TO DROP OFF YOUR WASTE EQUIPMENT FOR RECYCLING, PLEASE CONTACT YOUR HOUSEHOLD WASTE DISPOSAL SERVICE OR THE SHOP WHERE YOU PURCHASED THE PRODUCT.

## **Remote Control Battery Safety Information**

- Store batteries in any cool & dry place.
- Do not dispose used batteries in domestic waste. Dispose batteries at special collection points or return to stores if applies.
- Remove the batteries if they are not in use for long period of time. Battery leakage and corrosion can damage the remote control, dispose batteries safely.
- Do not mix and use old and new batteries.
- Do not mix and use different types of batteries: alkaline, standard (carbon-zinc) or rechargeable (nickel-cadmium).
- Do not dispose batteries in a fire.
- Do not attempt to short circuit the battery terminals.

# Table of Contents

|  |           |
|--|-----------|
| <b>Package Contents</b> .....  | <b>1</b>  |
| <b>Optional Accessories</b> .....  | <b>1</b>  |
| <b>Get Familiar with the AVerVision F17-8M</b> .....                       | <b>2</b>  |
| Right Panel.....   | 2         |
| Rear Panel .....   | 3         |
| Left Panel .....   | 3         |
| Control Panel.....   | 4         |
| Remote Control .....   | 6         |
| <b>Making the Connections</b> .....  | <b>9</b>  |
| Set the TV-RGB Switch Setting.....   | 9         |
| Connect to a Monitor or LCD/DLP Projector.....                             | 9         |
| Connect to a Monitor or LCD/DLP Projector with HDMI Output interface ..... | 10        |
| Connect to a TV.....   | 10        |
| Connecting the Power .....   | 11        |
| Connect to a Computer .....  | 11        |
| Connect to a Computer via USB.....   | 11        |
| Connect to a Computer with HDMI Input interface .....                      | 12        |
| Connect an External Microphone .....                                       | 12        |
| Connect an Amplified Speaker .....   | 13        |
| Connect to a Microscope.....   | 13        |
| <b>Setting Up AVerVision F17-8M</b> .....                                  | <b>14</b> |
| Storing and Handling .....   | 14        |
| Shooting Area .....  | 15        |
| Overhead Light.....  | 16        |
| Infrared Sensor.....   | 16        |
| Mounting the F17-8M on a Flat Surface .....                                | 17        |
| Anti-glare Sheet.....  | 17        |
| External Memory Storage .....  | 18        |
| Insert an SD Card .....  | 18        |
| Insert a USB Flash Drive .....   | 18        |
| <b>OSD MENU</b> .....  | <b>19</b> |
| Navigate the Menu and Submenu .....  | 20        |
| Image .....  | 20        |
| Brightness.....  | 20        |
| Contrast .....   | 20        |
| Mode.....  | 21        |
| Effect.....  | 21        |
| Mirror .....   | 21        |
| Advanced.....  | 21        |
| Auto Image .....   | 21        |
| Exposure .....   | 22        |
| White Balance.....   | 22        |
| Focus .....  | 22        |
| Presentation .....   | 23        |

|  |           |
|--|-----------|
| Spotlight.....                                     | 23        |
| Visor.....   | 23        |
| PIP.....   | 24        |
| Split Screen.....                                  | 24        |
| Timer.....   | 24        |
| Setting.....                                       | 25        |
| Capture.....                                       | 25        |
| Resolution.....                                    | 25        |
| Quality.....                                       | 25        |
| Type.....  | 25        |
| Interval.....                                      | 25        |
| Storage.....                                       | 26        |
| Format.....  | 26        |
| USB to PC.....                                     | 26        |
| Flicker.....                                       | 26        |
| Saturation.....                                    | 26        |
| Input Volume.....                                  | 27        |
| System.....  | 27        |
| Language.....                                      | 27        |
| Output Display.....                                | 27        |
| Backup.....  | 27        |
| Save Setting.....                                  | 28        |
| Recall Setting.....                                | 28        |
| Information.....                                   | 28        |
| Default.....                                       | 28        |
| Playback.....                                      | 28        |
| Slide Show.....                                    | 29        |
| Interval.....                                      | 29        |
| Effect.....  | 29        |
| Storage.....                                       | 29        |
| Delete All.....                                    | 29        |
| Annotation.....                                    | 30        |
| Connecting a USB mouse.....                        | 30        |
| Using the Annotation.....                          | 31        |
| Transfer Captured Images/Videos to a computer..... | 32        |
| <b>Technical Specifications.....</b>               | <b>33</b> |
| Image.....   | 33        |
| Optics.....  | 33        |
| Power.....   | 33        |
| Lighting.....                                      | 33        |
| Input/Output.....                                  | 33        |
| Dimension.....                                     | 33        |
| External Storage.....                              | 34        |
| Troubleshooting.....                               | 35        |
| <b>Limited Warranty.....</b>                       | <b>36</b> |

# Package Contents

Make sure the following items are included in the package.

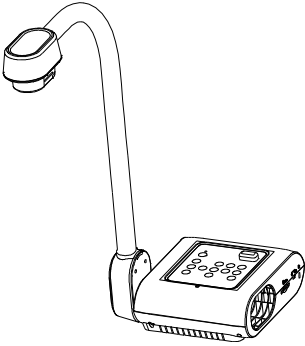

AVerVision F17-8M

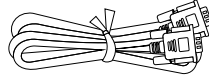

RGB Cable

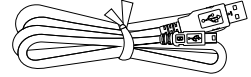

USB Cable

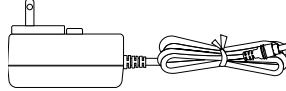

Power Adapter (12V, 2A)

\* The power adapter will vary depending on the standard power outlet of the country where it is sold.

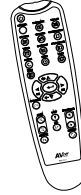

Remote Control  
(batteries included)

# Optional Accessories



Carrying Bag

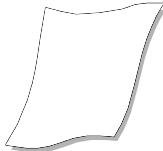

Anti-glare Sheet

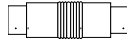

CVBS adapter

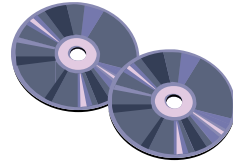

Software & Manual CD

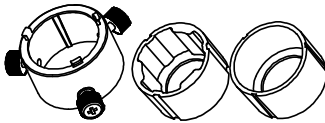

Microscope Adapter

( 28mm and 34mm Rubber Coupler are included)

# Get Familiar with the AVerVision F17-8M

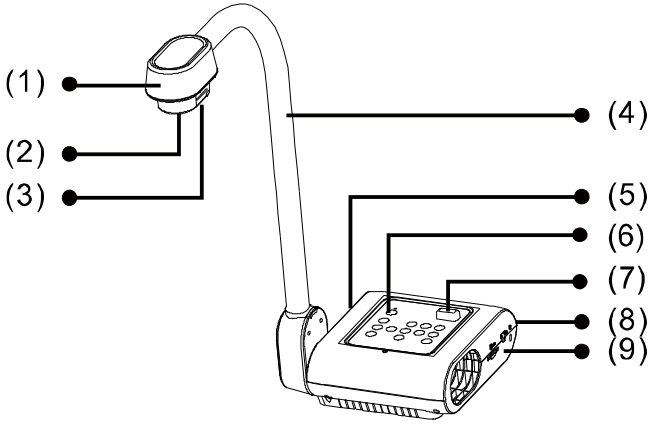

(fig. 1.1)

| Name              | Function   |
|-------------------|--|
| (1) Camera head   | Contain the camera sensor.   |
| (2) Camera lens   | Focus the image in the camera.   |
| (3) LED light     | Provide light to enhance the lighting condition.   |
| (4) Flexible arm  | Provide adjustable viewing coverage.   |
| (5) Left panel    | Connections for HDMI output/input external display device, microphone, speaker, and USB flash drive/USB mouse.                         |
| (6) Control panel | Easy access to various functions.  |
| (7) IR sensor     | Receive remote control commands.   |
| (8) Rear panel    | Connections for power, computer, RGB/RCA external display device, and USB to PC.   |
| (9) Right panel   | Connections for the camera head holder, SD card, TV-RGB display output switch, and antitheft Kensington security lock compatible slot. |

## Right Panel

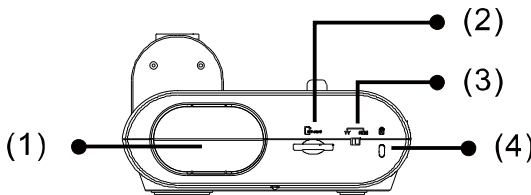

(fig. 1.2)

| Name               | Function   |
|--------------------|--|
| (1) Camera Holder  | Hold the camera head for storage.  |
| (2) SD card slot   | Insert the SD card with the label facing up.   |
| (3) TV-RGB switch  | TV switch to output display video from RCA (via CVBS adapter) to RGB OUT and HDMI OUT. |
| (4) Antitheft Slot | Attach a Kensington compatible security lock or antitheft device.                      |

## Rear Panel

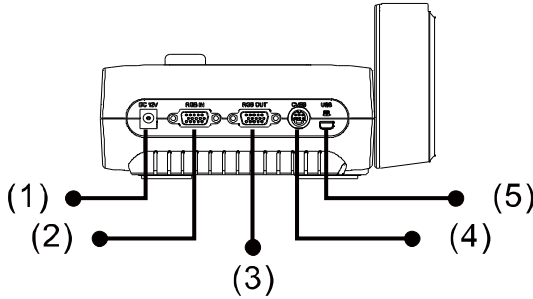

(fig. 1.3)

| Name                | Function  |
|---------------------|---|
| (1) DC12V           | Connect the power adapter into this port.   |
| (2) RGB INPUT port  | Input the signal from a computer or other sources and pass it through to the RGB OUT port only. Connect this port to the RGB/VGA output port of a computer.               |
| (3) RGB OUTPUT port | Connect the AVerVision F17-8M to any display device with RGB cable.   |
| (4) CVBS port       | Connect the supplied CVBS adapter into this port. The RCA jack outputs the video signal from the camera to a TV or video equipment.                                       |
| (5) Mini USB port   | Connect to a USB port of a computer with a USB cable and use AVerVision F17-8M as a USB camera or transfer the captured images/videos from the memory source to computer. |

## Left Panel

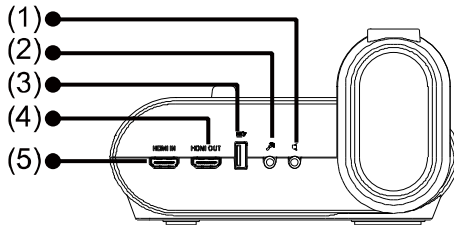





(fig. 1.4)

| Name              | Function   |
|-------------------|--|
| (1) Speaker port  | Connect to an amplified speaker to playback recorded audio & video clip.   |
| (2) MIC port      | Connect a 3.5mm plug microphone. The built-in mic will be disabled when an external MIC is connected to this port.                                   |
| (3) USB port      | Insert a USB flash drive save the images/video directly from the USB flash drive or use a USB mouse to annotate.                                     |
| (4) HDMI Out port | Output the video signal from the main system on an interactive flat panel, an LCD monitor or LCD/DLP projector with HDMI interface using HDMI cable. |
| (5) HDMI In port  | Connect an external HDMI source as an input via this port  |

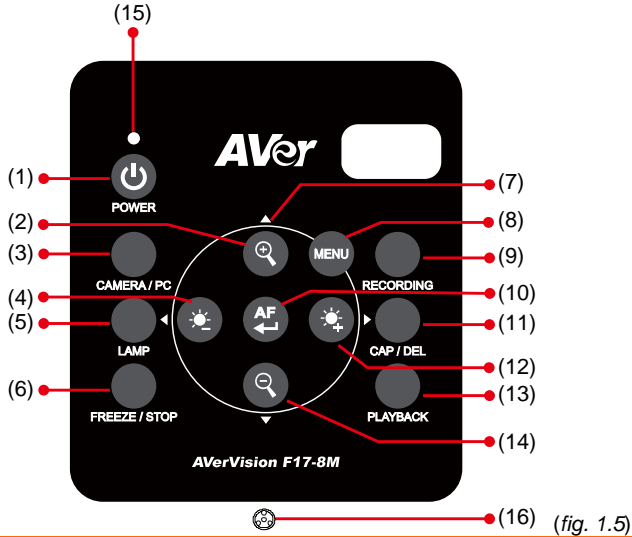

## Control Panel



| Name   | Function  |
|--|---|
| (1) POWER  | Turn the unit on/standby mode.  |
| (2)     | Increase the image magnification in camera and picture playback mode.   |
| (3) CAMERA / PC  | Switch the video signal between camera or computer from the RGB IN port.  |
| (4)     | Reduce the brightness of live view.   |
| (5) LAMP   | Turn the overhead light on/off.   |
| (6) FREEZE/STOP  | <ul style="list-style-type: none"> <li>- Pause or resume image display in Camera mode.</li> <li>- Stop audio &amp; video playback in Playback mode.</li> </ul>  |
| (7) ▲, ▼, ◀, & ▶   | <ul style="list-style-type: none"> <li>- Select options in OSD menu.</li> <li>- Use ▲&amp; ▼ to increase and decrease the video playback volume.</li> <li>- Use ◀&amp; ▶ to play the video backward and forward.</li> <li>- Move the Spotlight frame and Visor screen cover.</li> </ul> |
| (8) MENU   | Open and exit the OSD menu.   |
| (9) RECORDING  | Start/Stop audio & video recording. Audio and video recording can be saved either in a SD memory card or a USB flash drive. See <a href="#">External Memory Storage</a> .   |
| (10)  | <ul style="list-style-type: none"> <li>- Adjust the focus automatically.</li> <li>- Make a selection in Playback mode and OSD menu.</li> <li>- Start/Pause video playback.</li> </ul>   |
| (11) CAP/DEL   | <ul style="list-style-type: none"> <li>- Capture picture in Camera mode. In continuous capture mode, press this button again to stop.</li> <li>- Delete the selected picture/video in Playback mode.</li> </ul>   |
| (12)  | Increase the brightness of live view.   |

| Name   | Function   |
|--|--|
| (13) PLAYBACK  | View & playback captured still images and video files.   |
| (14)  | Decrease the image magnification in camera and picture playback mode.  |
| (15) Power LED indicator   | <ul style="list-style-type: none"><li>- <b>Red:</b> Standby</li><li>- <b>Green:</b> RGB/HDMI output</li><li>- <b>Orange:</b> TV output</li></ul> |
| (16) Built-in MIC  | Record audio when recording video clip. The recorded sound will be in monophonic.  |

## Remote Control

The remote control requires two (2) “AAA” size batteries (supplied), make sure batteries are installed properly before use. You can access all the features of AVerVision F17-8M with the remote.

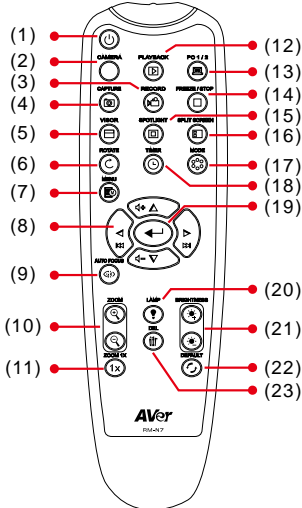

(fig. 1.6)

| Name        | Function  |
|-------------|---|
| (1) POWER   | Turn the unit on/standby.   |
| (2) CAMERA  | Camera mode displays the video signal from the built-in camera.   |
| (3) RECORD  | Start/Stop audio & video recording. Video recording can only be saved either in a SD memory card or a USB flash drive.  |
| (4) CAPTURE | Capture still image in Camera mode. In continuous capture mode, press this button again to stop.  |
| (5) VISOR   | Call the Visor submenu. Visor covers part of the presentation screen and allow presenter to reveal the material as desire. In the Visor submenu, the following options are available. <div data-bbox="644 726 879 901" data-label="Image"> </div> <p><b>ON/OFF</b> – select to run/cancel the Visor. Press  to move to the next selection.</p> <p><b>Shade</b> – set the opacity level of the covered area. The shaded area will completely turns black when it is set to level 100. Press  to move to the next selection.</p> <p><b>OK</b> – press  for the setting to take effect. If you select ON, upper part of the presentation screen is slightly exposed. Use the ▲, ▼, ◀, &amp; ▶ buttons to reveal more of the covered area; and OFF will close the submenu. To turn off Visor, press  again.</p> |
| (6) ROTATE  | Rotate the image by 0/180° in Camera mode and Playback mode.  |
| (7) MENU    | Open and exit the OSD menu.   |

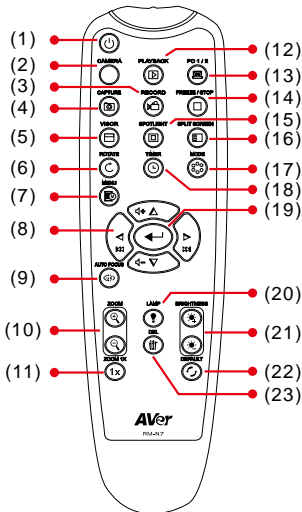





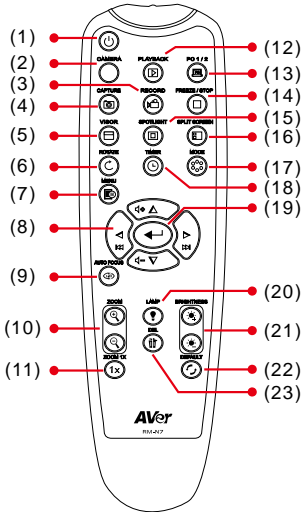



(fig. 1.6)

| Name               | Function   |
|--------------------|--|
| (8) ▲, ▼, ◀, & ▶   | <ul style="list-style-type: none"> <li>- Pan and zoom-in image (above digital zoom level) in both live and playback mode.</li> <li>- Select options in OSD menu.</li> <li>- Use ▲&amp;▼ to increase and decrease the video playback volume.</li> <li>- Use ◀&amp;▶ to play the video backward and forward.</li> <li>- Move the Spotlight frame and Visor screen cover.</li> </ul>  |
| (9) AUTO FOCUS     | Adjust the focus automatically.  |
| (10) ZOOM +/-      | Increase/decrease the image magnification in camera and picture playback mode.   |
| (11) ZOOM RESET    | Reset zoom level to 100%.  |
| (12) PLAYBACK      | View the captured picture/video from the memory in 16-thumbnail images.  |
| (13) PC 1/2        | PC mode displays the video signal from the RGB INPUT port of F17-8M.   |
| (14) FREEZE / STOP | <ul style="list-style-type: none"> <li>- Freeze live images.</li> <li>- Stop video playback.</li> </ul>  |
| (15) SPOTLIGHT     | <p>Call the Spotlight submenu. Spotlight overlays a box frame on the presentation screen. You can adjust the box size and move it around. In the Spotlight submenu, the following options are available.</p> <div data-bbox="647 938 875 1114" data-label="Image"> </div> <ul style="list-style-type: none"> <li><b>ON/OFF</b> – select to run/cancel the Spotlight. Press ◀ to move to the next selection.</li> <li><b>Shade</b> – set the opacity level of the area outside the box. The shaded area will completely turns black when it is set to level 100. Press ◀ to move to the next selection.</li> <li><b>Color</b> – select the Spotlight frame color. Press ◀ to move to the next selection.</li> </ul> |

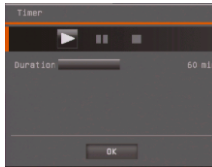

(fig. 1.6)





| Name   | Function  |
|--|---|
| (15) SPOTLIGHT   | <b>OK</b> – press  for the setting to take effect. If you select ON, the frame will appear and blink, use the  ,  ,  , &  buttons to adjust the frame size and press  to set the desired size; and OFF will close the submenu.<br>To turn off Spotlight, press  again. |
| (16) SPLIT SCREEN  | Divide the screen into two. One side displays the live image from the built-in camera and the other side displays 8-thumbnail size picture/video from the memory.   |
| (17) MODE  | Select from 3 type of modes:<br><b>Sharp</b> - adjust the contrast along the edges making text appear more visible.<br><b>Graphics</b> - adjust the gradient of image.<br><b>Microscope</b> - automatically adjust optical zoom for microscopic viewing.  |
| (18) TIMER   | Call the Timer submenu. Select to Start/Pause/Stop the timer countdown and set the timer duration.<br>   |
| (19)  | - Make a selection in Playback mode and OSD menu.<br>- Play/Pause video playback.   |
| (20) LAMP  | Turn the overhead light on/off.   |
| (21) BRIGHTNESS +/-  | Adjust the brightness.  |
| (22) DEFAULT   | Reset to factory default setting.   |
| (23) DEL   | Delete the selected picture/video in Playback mode.   |

# Making the Connections

Before making the connection, make sure the power of all devices are turned off. If you are not sure on where to connect, simply follow the illustrated connections below and also refer to the user manual of the device you are connecting the AVerVision F17-8M with.

## Set the TV-RGB Switch Setting

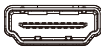
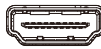
The TV-RGB switch determines the display output selection. Switch it to RGB (right) to output signal using RGB/HDMI connection and TV (left) to output signal using RCA connection. (see fig. 1.2 # 3)

| Switch | AVerVision Port  | To | Display Device Port  |
|--------|--|----|--|
| RGB    | <br><b>RGB OUTPUT</b>                             | To | <br><b>RGB INPUT</b>  |
|        | <br><b>HDMI OUTPUT</b>                            |    | <br><b>HDMI INPUT</b> |
| TV     | <br><b>CVBS</b><br>(use CVBS cable)<br>(Optional) |    | <br><b>VIDEO IN</b>   |

## Connect to a Monitor or LCD/DLP Projector

Locate the RGB (VGA) input port of the graphics display device and connect it to RGB OUT port of AVerVision F17-8M.



Make sure the TV/RGB switch is set to RGB.

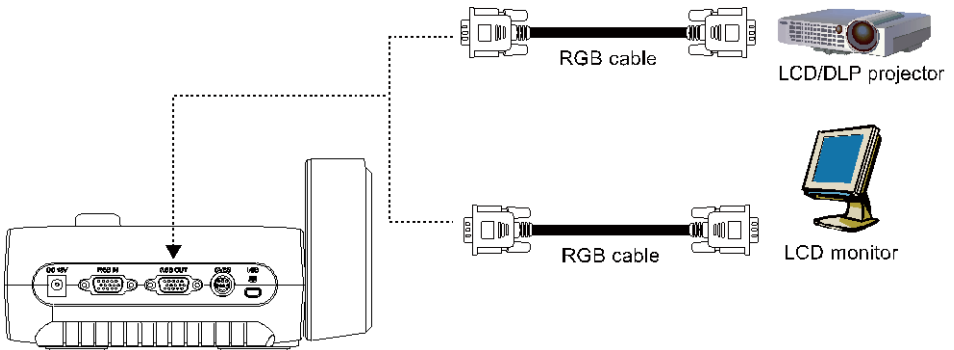

# Connect to a Monitor or LCD/DLP Projector with HDMI Output interface

Locate the HDMI input port of the display device and connect it to HDMI out port of AVerVision F17-8M.



Make sure the TV/RGB switch is set to RGB.

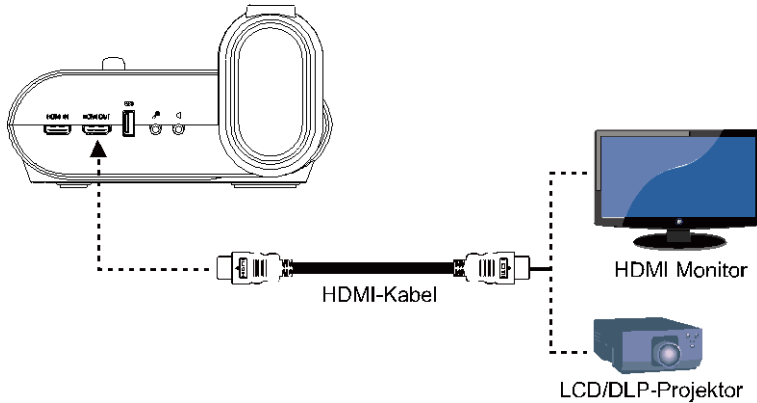

# Connect to a TV

Locate the VIDEO or SCART RGB (if applicable) input port of the TV or Video equipment (i.e., VCR) to record your presentation and connect it to RCA jack of CVBS adapter.

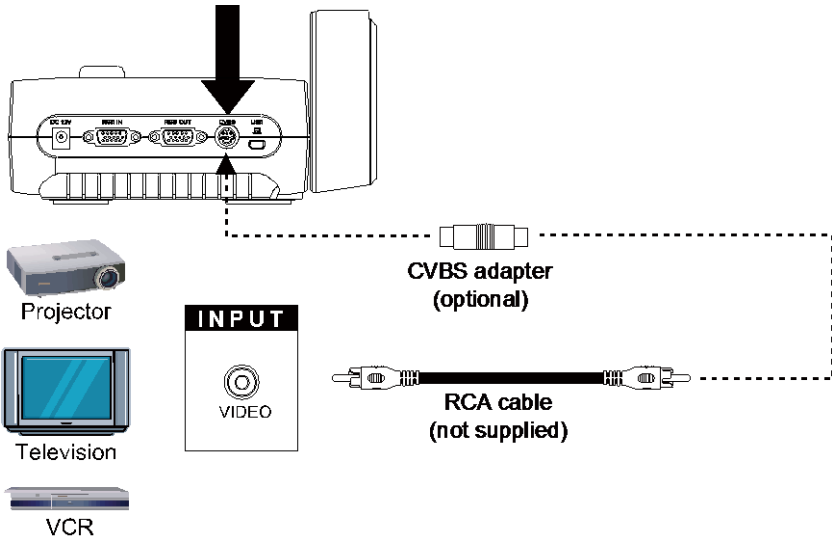

## Connecting the Power

Connect the power adapter to a standard 100V~240V AC power outlet. The unit automatically in standby mode once the power is connected. Press  to turn on.

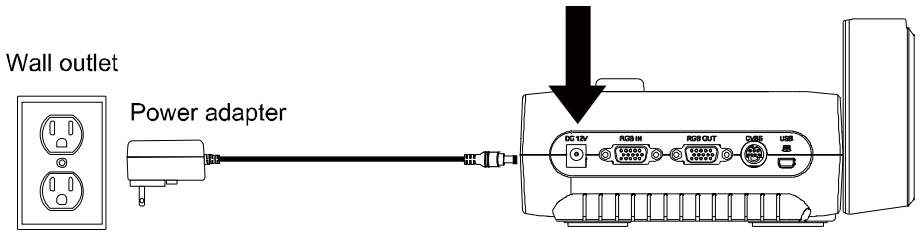

## Connect to a Computer

Locate the RGB (VGA) output port of the computer or laptop and connect it to RGB IN port of AVerVision F17-8M. The video signal from the RGB IN port is streamed to RGB OUT.



- To display computer image, press Camera/PC button on the control panel or remote control to switch AVerVision F17-8M to computer mode.
- For laptop to output display image, use the keyboard command (FN+F5) to switch between the display modes. For different command, please refer to your laptop manual.

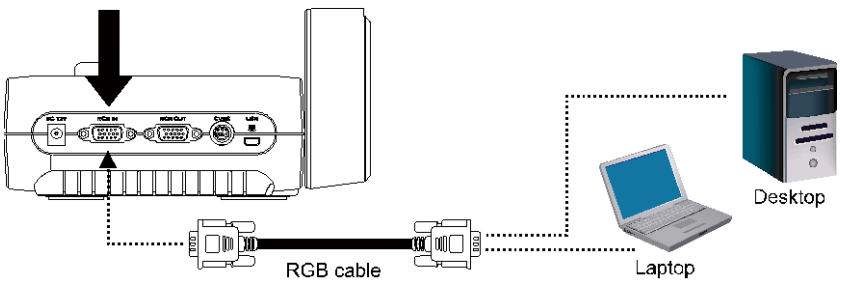

## Connect to a Computer via USB

Locate the USB port of the computer or laptop and connect it to PC port of AVerVision F17-8M.

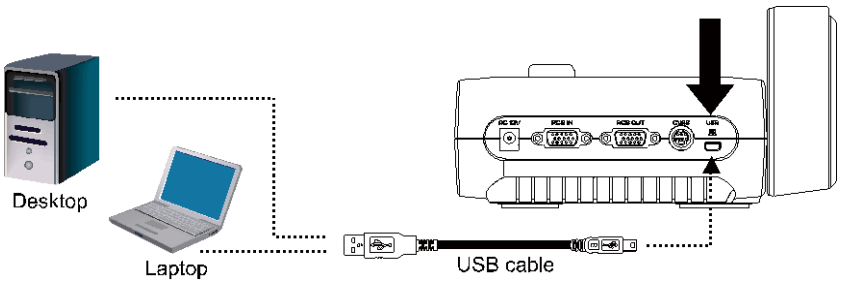



## Connect to a Computer with HDMI Input interface

Locate the HDMI output port of the computer or laptop and connect it to HDMI in port of AVerVision F17-8M.



- Make sure the TV/RGB switch is set to RGB.
- To display computer image, press Camera/PC button on the control panel or remote control to switch AVerVision F17-8M to computer mode.
- For laptop to output display image, use the keyboard command (FN+F5) to switch between the display modes. For different command, please refer to your laptop manual.

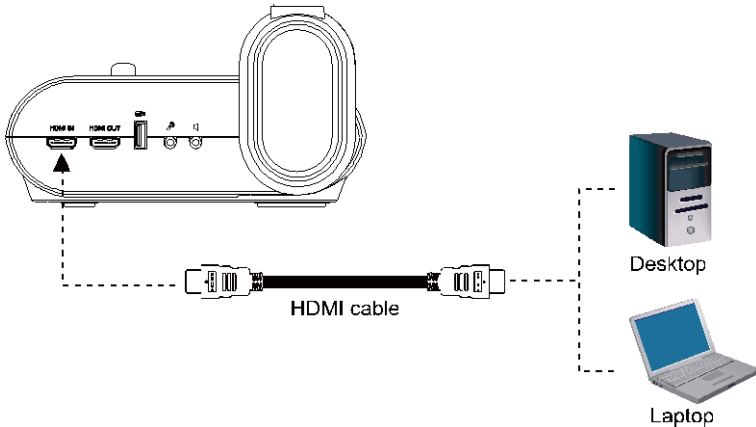

## Connect an External Microphone

Plug a 3.5mm mono microphone to  port. The built-in microphone on the control panel will be disabled when an external microphone is connected. The recorded audio will be in monophonic sound.

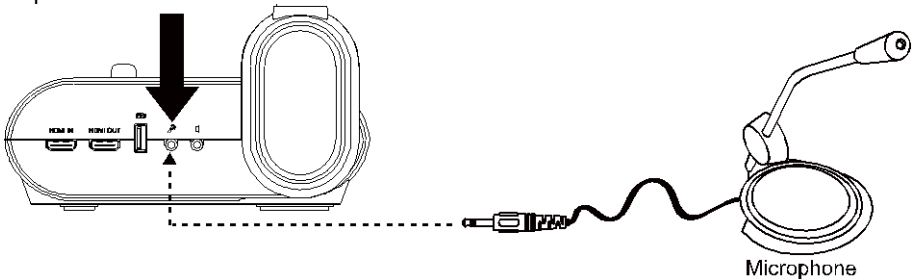

## Connect an Amplified Speaker

Plug a 3.5mm plug amplified speaker to  port. Only the audio from the video playback is supported.



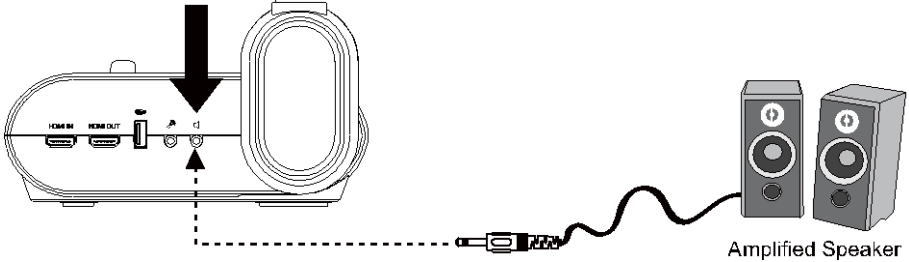

We recommend connecting an amplified speaker to the Audio output port. Take caution when using earphones. Adjust the volume down on the remote to prevent hearing damage due to loudness.



## Connect to a Microscope

Connect the AVerVision F17-8M to a microscope enables you to examine microscopic objects on a big screen.

1. Change the image display mode to Microscope. Press **MENU** > select **IMAGE** tab > select **MODE** > select  **(microscope)** and press .

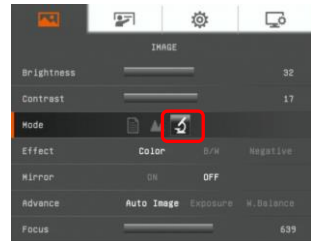

2. Aim the camera head at the farthest point and press **AUTO FOCUS**.

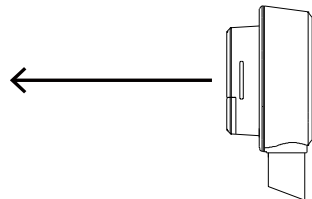

3. Adjust the focus of the microscope.

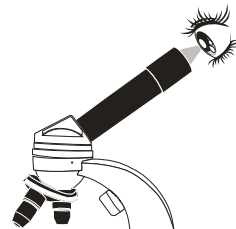

4. Select the appropriate rubber coupler size for the microscope eyepiece and insert it in the microscope adapter.

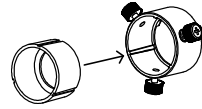

5. Remove the microscope eyepiece from the microscope and connect it to the microscope adapter with the rubber coupler inserted. Fasten the 3 bolts until the adapter secures the eyepiece.

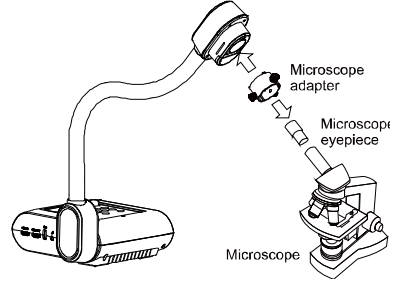

- For the eyepiece, we suggest using 15 mm eye relief or higher.
- Do the adjustment manually to get better image view.

6. Attach the microscope adapter to the AVerVision camera head. Then connect it to the AVerVision and microscope.

Make sure the arrow on the camera head and microscope adapter are on the same side to connect and twist clockwise for the arrows to meet and lock.

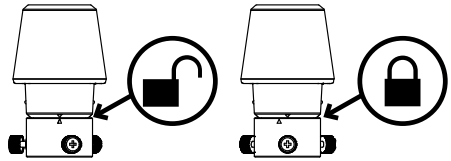

## Setting Up AVerVision F17-8M

This section provides useful tips on how to adjust the AVerVision F17-8M to meet your needs.

### Storing and Handling

The gooseneck design allows you to freely bend the arm and store the camera head in the camera holder. Once you have properly secured the camera head to the camera holder, you may use the arm to carry AVerVision F17-8M.

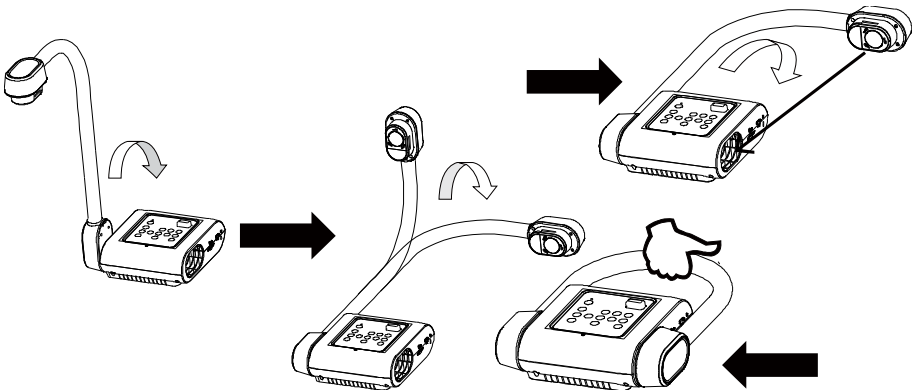

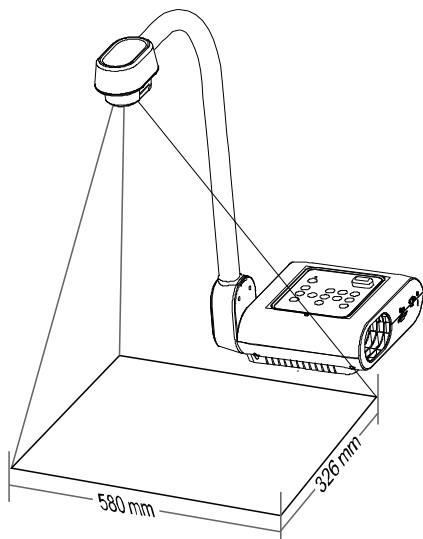

## Shooting Area

The shooting area can view an area of 580\*326mm (at 1080P).

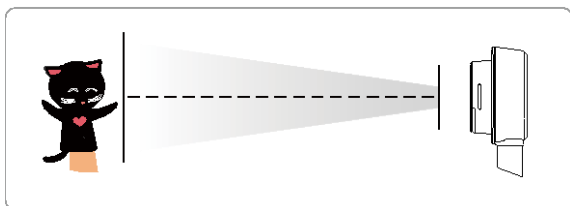

If the camera head is in upright position, press ROTATE on the control panel or remote control twice to rotate the image in 180°.



To mirror the image, press MENU > select Mirror, press , and select On.

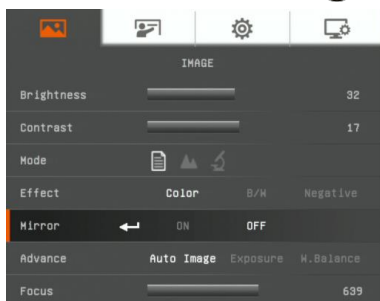

## Overhead Light

Press LAMP button on the control panel or remote control to turn on and off light.

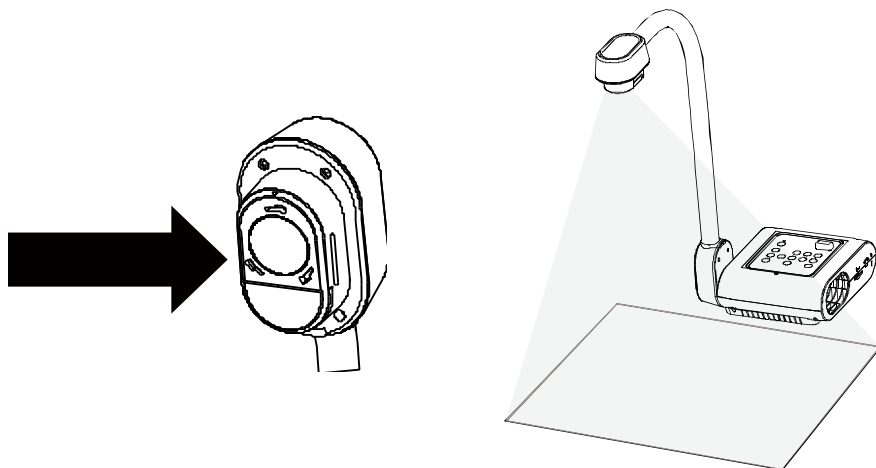

## Infrared Sensor

Aim the remote control at the infrared sensor to operate the unit.

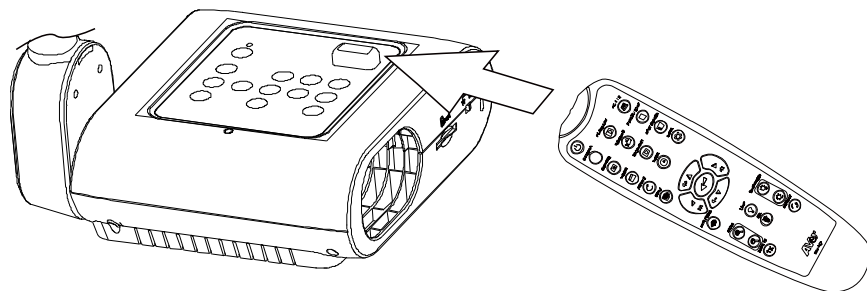

## Mounting the F17-8M on a Flat Surface

Measure and mark the horizontal of 75 mm from the center line distance between the holes on the flat surface as describe in the illustration below. Use 2 pieces of M4.0 screws for 6 mm holes and secure the F17-8M on the flat surface.

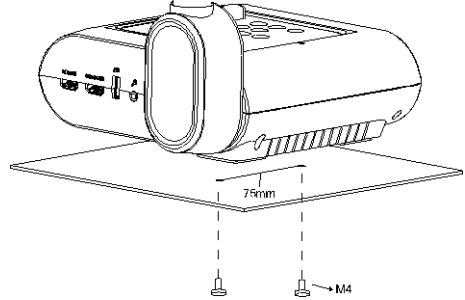
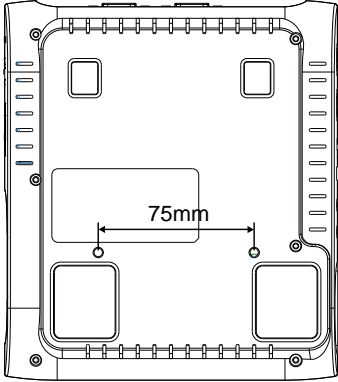

## Anti-glare Sheet

The anti-glare sheet is a special coated film that helps eliminate any glare that maybe encountered while displaying very shiny objects or glossy surfaces such as magazines and pictures. To use, simply place the anti-glare sheet on top of the shiny document to reduce reflected light.

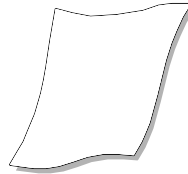

# External Memory Storage

AVerVision F17-8M supports both SD memory card and USB flash drive for more image capture and audio & video recordings. AVerVision F17-8M can detect when there is an external storage media and automatically switch to the last detected storage. If no external storage is connected, all captured still images will be saved in the built-in memory.

## Insert an SD Card

Insert the card with the contact facing down until it reaches the end. To remove the card, push to eject and pull the card out. The supported SD card capacity is from 1GB to 32GB (FAT32). We recommend using SDHC card with class-6 or above for high quality recording.

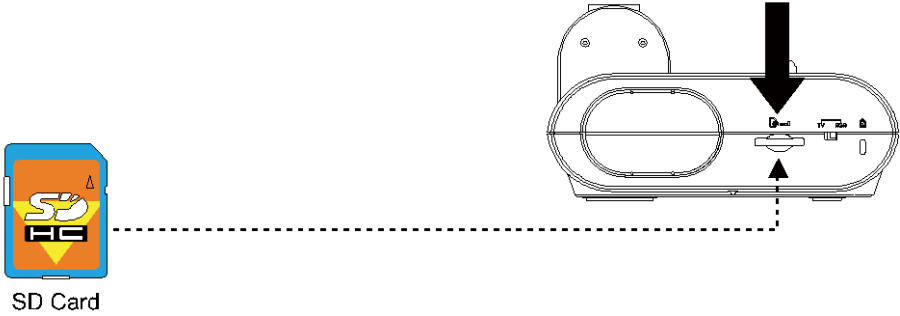

## Insert a USB Flash Drive

Connect the USB flash drive in the USB slot. AVerVision F17-8M can support USB flash drive from 2GB to 64GB (FAT32). **Best to format the USB flash drive using AVerVision F17-8M for better video recording.**

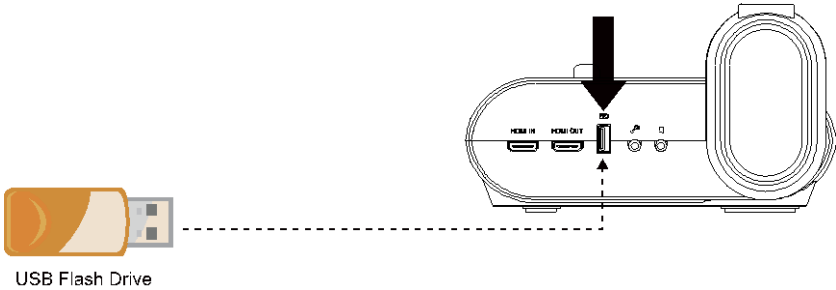

# OSD MENU

There are 4 tabs on the OSD menu: IMAGE, PRESENTATION, SETTING and SYSTEM. In Playback mode, you can access PLAYBACK OSD menu to enable the Slide Show feature and modify Slide Show interval and transition setting if desire.



For TV output, the RESOLUTION will be disabled in SETTING menu list.

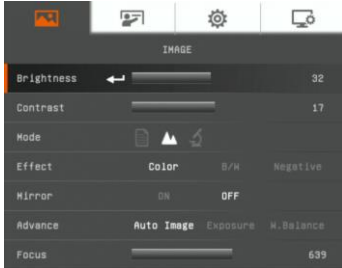

IMAGE

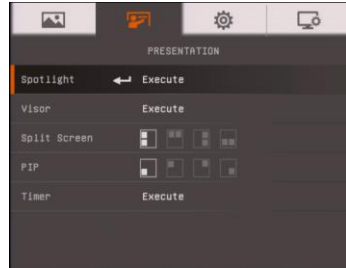

PRESENTATION



SETTING

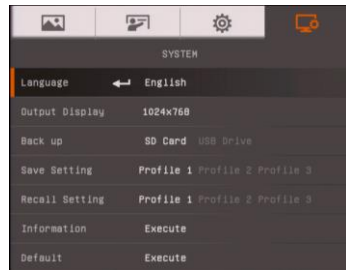

SYSTEM

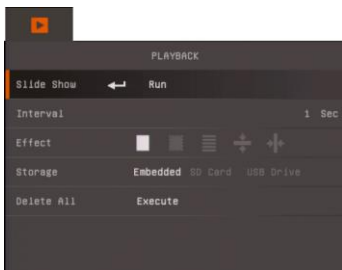

PLAYBACK



ANNOTATION



# Navigate the Menu and Submenu

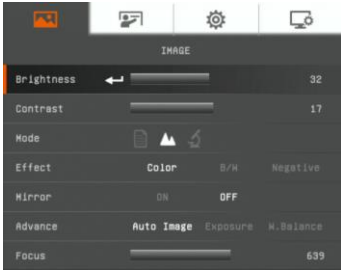

1. Press MENU button on the remote or control panel.
2. Press ► and ◀ to toggle between tabs
3. Press ▼ and ▲ to choose a selection in the menu list.
4. Press ⏪ to make a selection.
5. Use ► and ◀ to adjust the setting or make a selection.
6. Press ⏪ to enter submenu.
7. Press MENU to close the OSD menu.

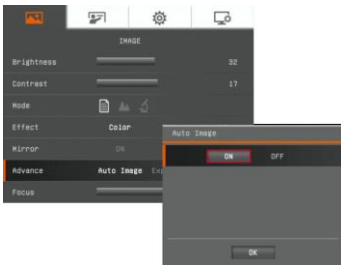

# Image

## Menu Screen

## Function

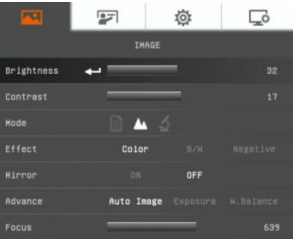

### Brightness

Adjust brightness level manually between 1 and 64.

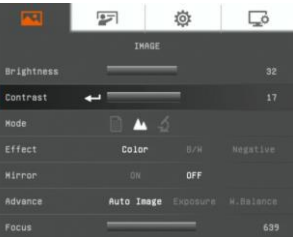

### Contrast

Adjust the contrast level manually between 1 and 32 under bright and dark environments.

## Menu Screen

## Function

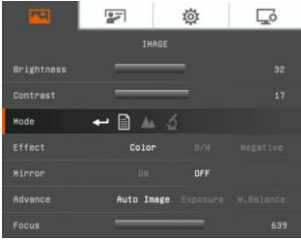

### Mode

Select from the various image display settings.

 **Sharp** - adjust the contrast along the edges making text appear more visible.

 **Graphics** - adjust the gradient of image.

 **Microscope** - automatically adjust zoom ratio for microscopic viewing.

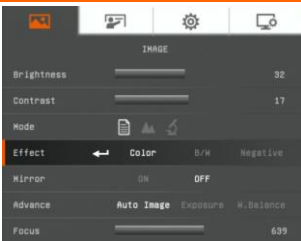

### Effect

Convert the image into positive (true color), monochrome (black and white) or negative.

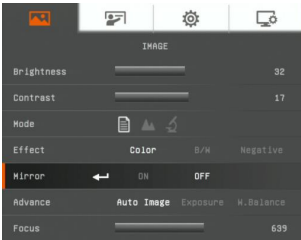

### Mirror

Select to flip the image in Camera mode.

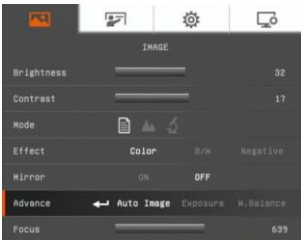

### Advanced

Select to set the Auto Image, Exposure, and White Balance settings.

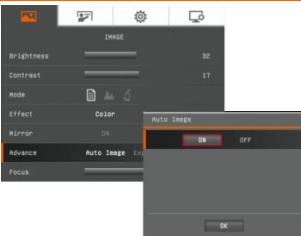

### Auto Image

Select ON or OFF to automatically adjust the white balance and exposure setting, and correct the color and exposure compensation.

## Menu Screen

## Function

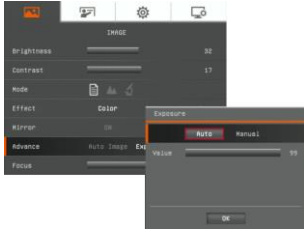

### Exposure

Select the exposure setting.

**AUTO** - automatically adjust the camera exposure and the amount of light required.

**MANUAL** - manually adjust the exposure level. The exposure can be adjusted up to 100.



### White Balance

Select the White Balance setting for various light conditions or color temperature.

**AUTO** - automatically adjust the white balance.

**MANUAL** - manually adjust the red and blue color level. The color level can be adjusted up to 255.

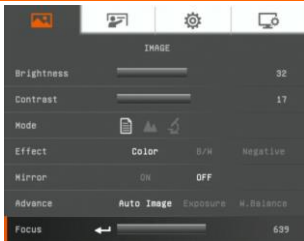

### Focus

Manually adjust the focus.

# Presentation

## Menu Screen

## Function

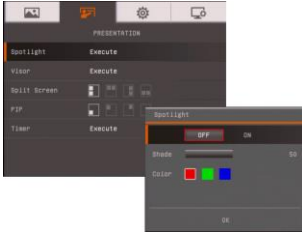

### Spotlight

Spotlight overlays a frame on the presentation screen. You can move the Spotlight around the presentation screen using the ▲, ▼, ◀, & ▶ buttons. Select Execute to call the Spotlight submenu.



In the Spotlight submenu, the following options are available.



**ON/OFF** – select to run/cancel the Spotlight. Press ◀ to move to the next selection.

**Shade** – set the opacity level of the area outside the box. The shaded area will completely turn black when it is set to level 100. Press ◀ to move to the next selection.

**Color** – select the Spotlight frame color. Press ◀ to move to the next selection.

**OK** – press ◀ for the setting to take effect. If you select ON, the frame will appear and blink, use the ▲, ▼, ◀, & ▶ buttons to adjust the frame size and press ◀ to set the desired size; and OFF will close the submenu.

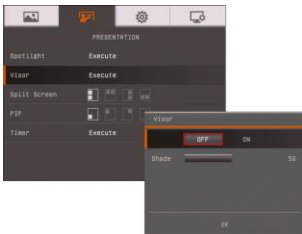

### Visor

Visor covers the presentation screen. The upper part of the presentation screen is slightly exposed. Use the ▲, ▼, ◀, & ▶ buttons to reveal more of the covered area. Select Execute to call the Visor submenu.

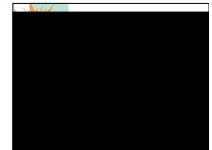

## Menu Screen

## Function

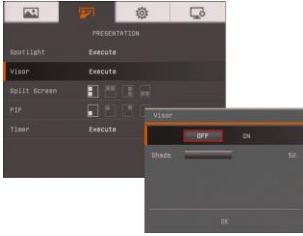

In the Visor submenu, the following options are available.

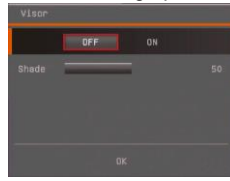

**ON/OFF** – select to run/cancel the Visor. Press to move to the next selection.

**Shade** – set the opacity level of the covered area. The shaded area will completely turns black when it is set to level 100. Press to move to the next selection.

**OK** – press for the setting to take effect. If you select ON, upper part of the presentation screen is slightly exposed. Use the , , , & buttons to reveal more of the covered area; and OFF will close the submenu.

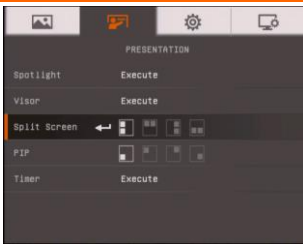

### PIP

Select the thumbnail playback screen location and show the thumbnail playback screen at the corner of the screen to recall the captured image from the memory in Camera mode. Select OFF to cancel PIP.

- Lower Left
- Upper Left
- Upper Right
- Lower Right

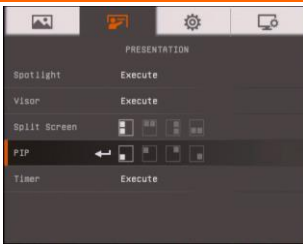

### Split Screen

Divide the screen into two parts. Half of the screen displays the 8-thumbnail images and the other half display the image from the AVerVision F17-8M camera.

Select the display location of the 8- thumbnail playback images. Select OFF to cancel Split Screen.

- Left
- Right
- Top
- Below

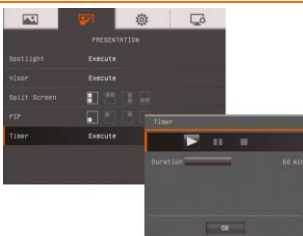

### Timer

Start/Pause/Stop the timer and set the timer duration. The timer automatically counts up after the countdown reaches zero to show the elapsed time. Even when you switch between Playback, PC or Camera modes, the timer will continue.

# Setting

## Menu Screen

## Function

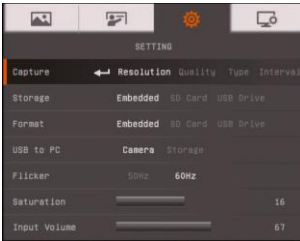

### Capture

Select to set the capture resolution, quality, type and interval settings.

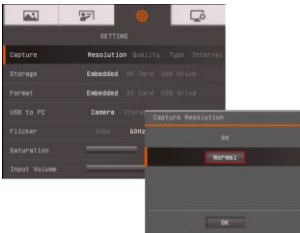

### Resolution

Select the capture size. In 8M setting, the capture resolution size is 3840 X 2160.

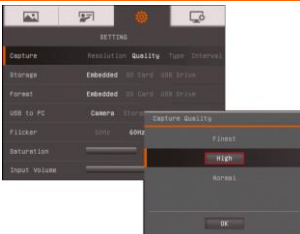

### Quality

Select the capture compression setting.



### Type

Select the capture type.

**Single** - capture one picture only.

**Continuous** - capture successive pictures.

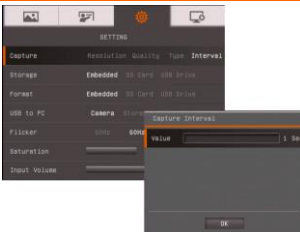

### Interval

Set the time interval for continuous capture. The length can be set up to 600 sec (10 min).

## Menu Screen

## Function



### Storage

Change the storage location. Audio & video recording can only be saved in SD memory card or USB flash drive.

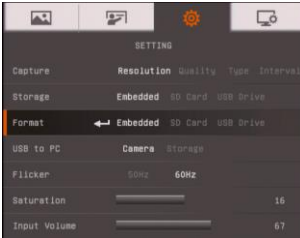

### Format

Format to delete all the data in the selected memory.



### USB to PC

Select the status of the AVerVision F17-8M when it is connected to the computer via USB.

**Camera** - can be used as a computer webcam or with our bundled software to record video and capture still image.

**Storage** - transfer the captured pictures/videos from the memory to computer hard disk.

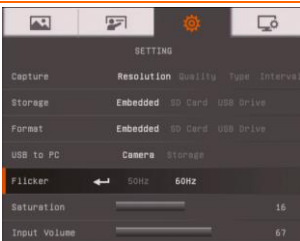

### Flicker

Select between 50Hz or 60Hz. Some display devices cannot handle high refresh rates. The image will flicker a couple of times as the output is switched to another refresh rate.

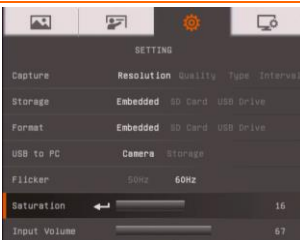

### Saturation

Adjust the value of saturation.

## Menu Screen

## Function



### Input Volume

Adjust volume input of recording or USB audio input.

## System

## Menu Screen

## Function

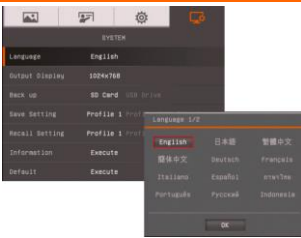

### Language

Change and select different language.

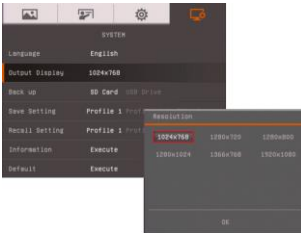

### Output Display

Set the resolution to display the image on screen. This selection will be disabled in TV output mode.

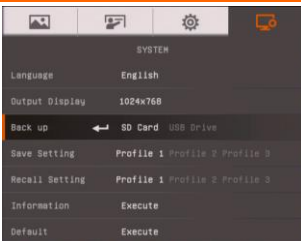

### Backup

Copy the image from the built-in memory to SD card or USB flash drive.



## Menu Screen

## Function



### Save Setting

Save current setting in the selected profile number. Only effect, mode, brightness and contrast settings can be saved.



### Recall Setting

Restore the setting back to the selected profile number.

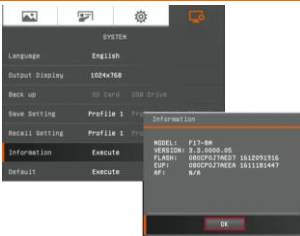

### Information

Display the product information.

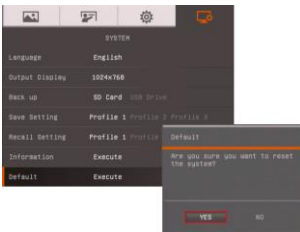

### Default

Restore all the settings into original factory default setting.

## Playback

## Menu Screen

## Function

## Menu Screen

## Function

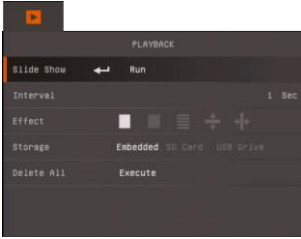

### Slide Show

Display all captured still pictures in an automated slide show. The video file will be skipped.

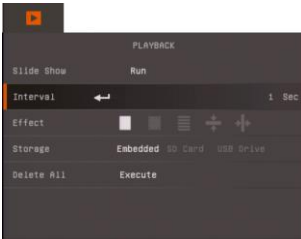

### Interval

Set the interval before displaying the next picture. The length can be set up to 100 sec.

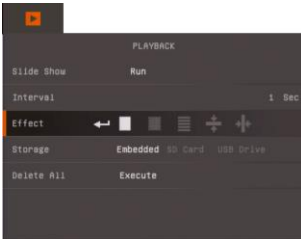

### Effect

Select the slide show transition effect.



Slide image



Split Vertical Out



Checker down



Split Horizontal In



Wipe down

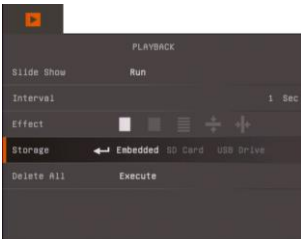

### Storage

Select the source of the images.

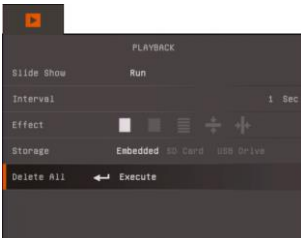

### Delete All

Permanently delete all the data in selected memory source. A Warning Message will appear. Select YES to continue and NO to stop formatting the storage.

## Annotation

In single image playback mode and preview mode, you can use the annotation feature to overlay straight line or freeform line on the captured image with the USB mouse connected to the USB port of AVerVision F17-8M. It comes with the following selections: Color Palette, Line Thickness, Line, Freehand, Capture, Eraser, and Hide/Show icons.

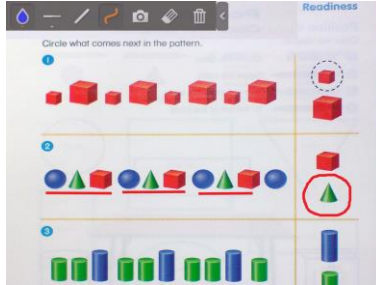





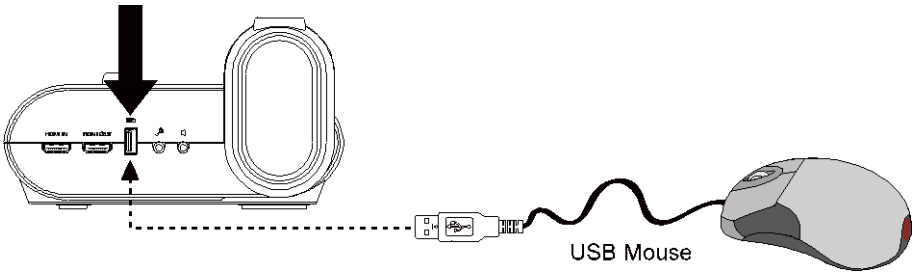

## Connecting a USB mouse

Connect the USB cable to the USB slot of AVerVision F17-8M.



# Using the Annotation

1. In camera mode, press  (Freeze/Stop) button to call out annotation menu.
2. In playback back mode, Press  on the remote. Then, use the , , , &  buttons and select the image you want to annotate in the 16-thumbnail preview. Press  to make a selection and display the image in full screen. The annotation menu will appear on the upper left corner of the screen.

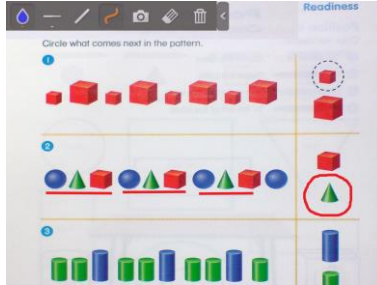

3. Use the mouse and move the “+” cursor on the item in the annotation panel you want to use. Then left click the mouse button to make a selection.



| Name           | Function   |
|----------------|--|
| Color Palette  | Select the line color.   |
| Line Thickness | Select the thickness of the line.  |
| Line           | Select to draw a straight line.  |
| Freehand       | Select to draw freeform line.  |
| Capture        | Capture the image with the annotation and save it as a new file.                                   |
| Eraser         | Select to erase any part of the annotation that it comes in contact with or delete all annotation. |
| Hide/Show      | Shrink or expand the annotation menu.  |

# Transfer Captured Images/Videos to a computer

This enables you to transfer the captured image from the built-in memory or SD to a computer.



The instruction below **MUST** be read and followed **BEFORE** connecting the USB cable.

1. **MUST** set the USB to PC as STORAGE before connecting the USB cable.

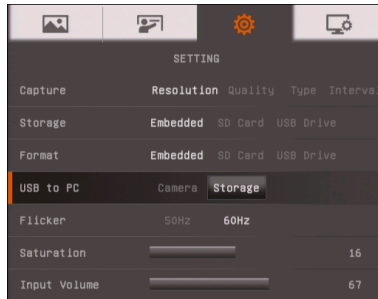

2. When “**Mass Storage Start...**” appears at the lower right corner of the presentation screen, you may now connect the USB cable.
3. Upon connecting the USB cable, the system automatically detects the new removable disk. You can now transfer the captured image(s) from the **F17-8M built-in memory** to the computer hard disk.

# Technical Specifications

## Image

|               |  |
|---------------|--|
| Sensor        | 1/3.2" CMOS  |
| Pixel Count   | 8 megapixels   |
| Frame Rate    | 30 fps (max.)  |
| White Balance | Auto / Manual  |
| Exposure      | Auto / Manual  |
| Image mode    | Sharp / Graphics / Microscope                                  |
| Effect        | Color / B/W / Negative / Mirror / Rotate / Freeze              |
| RGB output    | 1920x1080, 1280x1024, 1280x720, 1024x768, 1280 x 800, 1366x768 |
| HDMI Output   | HD 1080p 60Hz; HD 720p 60Hz                                    |
| Image Capture | 240 Frames(XGA)  |

## Optics

|               |   |
|---------------|---|
| Focusing      | Auto / Manual   |
| Shooting Area | 580mm x 326mm   |
| Zooming       | Total Zoom = 27.2X (1.7X AVerZoom™, 16X Digital Zoom) |

## Power

|              |   |
|--------------|---|
| Power Source | DC 12V, 100-240V, 50-60Hz                 |
| Consumption  | 12.3 Watts (lamp off); 13 Watts (lamp on) |

## Lighting

|           |           |
|-----------|-----------|
| Lamp Type | LED light |
|-----------|-----------|

## Input/Output

|                 |  |
|-----------------|--|
| RGB Input       | 15-Pins D-sub (VGA)                        |
| RGB Output      | 15-Pins D-sub (VGA)                        |
| HDMI Output     | HDMI                                       |
| HDMI Input      | HDMI                                       |
| CVBS            | Mini-DIN Jack (use CVBS adapter _optional) |
| Composite Video | RCA Jack                                   |
| USB             | USB2.0                                     |
| DC 12V Input    | Power Jack                                 |
| MIC             | Phone Jack                                 |
| Speaker         | Phone Jack                                 |

## Dimension

|           |                            |
|-----------|----------------------------|
| Operating | 380mm(L)*200mm(W)*525mm(H) |
| Folded    | 305mm(L)*230mm(W)*73mm(H)  |
| Weight    | 2.5kg(5.51 lbs)            |

## External Storage

|                       |                    |
|-----------------------|--------------------|
| Secure Digital (SDHC) | 1GB ~ 32GB (FAT32) |
| USB Flash Drive       | 2GB ~ 64GB (FAT32) |

# Troubleshooting

This section provides many useful tips on how to solve common problems while using the AVerVision F17-8M.

## **There is no picture on the presentation screen.**

1. Check all the connectors again as shown in this manual.
2. Check the on/off switch of the display output device.
3. Verify the setting of the display output device.
4. If you are presenting from a notebook or computer through the display output device, check the cable connection from computer RGB (VGA) output to RGB input of AVerVision F17-8M and make sure AVerVision F17-8M is in PC Mode.

## **I have set up the AVerVision F17-8M and checked all the connections as specified in the manual but I cannot get a picture on the preferred presentation screen.**

1. Once the power is connected the unit is set to standby mode. Press the POWER button to turn on.
2. If your display output device is on TV or any analog device, please switch the TV-RGB dip switch to TV.

## **The picture on the presentation screen is distorted or the image is blurry.**

1. Reset all changed settings, if any, to the original manufacturer default setting. Press MENU then go to SYSTEM > Default and select YES in the OSD menu.
2. Use the Brightness and Contrast menu functions to reduce the distortion if applicable.
3. If you discover that the image is blurry or out of focus, press the Auto Focus button on the control panel or remote control.

## **There is no computer signal on presentation screen.**

1. Check all the cable connections among the display device, AVerVision F17-8M and your PC.
2. Connect your PC to the AVerVision F17-8M first before you power on your computer.
3. For notebook, repeatedly press FN+F5 to toggles between display modes and display the computer image on the presentation screen. For different command, please refer to your laptop manual.

## **The presentation screen does not show the exact desktop image on my PC or Notebook after I toggle from Camera to PC mode.**

1. Return to your PC or Notebook, place the mouse on the desktop and right click, choose "Properties", choose "Setting" tab, click on "2" monitor and check the box "Extend my Windows desktop onto this monitor".
2. Then go back one more time to your PC or Notebook and place the mouse on the desktop and right click again.
3. This time choose "Graphics Options", then "Output To", then "Intel® Dual Display Clone", and then choose "Monitor + Notebook".
4. After you follow these steps, you should be able to see the same desktop image on your PC or Notebook as well as on the presentation screen.



## Limited Warranty

For a period of time beginning on the date of purchase of the applicable product and extending as set forth in the **“Warranty Period of AVer Product Purchased”** section of the warranty card, AVer Information, Inc. (“AVer”) warrants that the applicable product (“Product”) substantially conforms to AVer’s documentation for the product and that its manufacture and components are free of defects in material and workmanship under normal use. “You” as used in this agreement means you individually or the business entity on whose behalf you use or install the product, as applicable. This limited warranty extends only to You as the original purchaser. Except for the foregoing, the Product is provided “AS IS.” In no event does AVer warrant that You will be able to operate the Product without problems or interruptions, or that the Product is suitable for your purposes. Your exclusive remedy and the entire liability of AVer under this paragraph shall be, at AVer’s option, the repair or replacement of the Product with the same or a comparable product. This warranty does not apply to (a) any Product on which the serial number has been defaced, modified, or removed, or (b) cartons, cases, batteries, cabinets, tapes, or accessories used with this product. This warranty does not apply to any Product that has suffered damage, deterioration or malfunction due to (a) accident, abuse, misuse, neglect, fire, water, lightning, or other acts of nature, commercial or industrial use, unauthorized product modification or failure to follow instructions included with the Product, (b) misapplication of service by someone other than the manufacturer’s representative, (c) any shipment damages (such claims must be made with the carrier), or (d) any other causes that do not relate to a Product defect. The Warranty Period of any repaired or replaced Product shall be the longer of (a) the original Warranty Period or (b) thirty (30) days from the date of delivery of the repaired or replaced product.

### Limitations of Warranty

AVer makes no warranties to any third party. You are responsible for all claims, damages, settlements, expenses, and attorneys’ fees with respect to claims made against You as a result of Your use or misuse of the Product. This warranty applies only if the Product is installed, operated, maintained, and used in accordance with AVer specifications. Specifically, the warranties do not extend to any failure caused by (i) accident, unusual physical, electrical, or electromagnetic stress, neglect or misuse, (ii) fluctuations in electrical power beyond AVer specifications, (iii) use of the Product with any accessories or options not furnished by AVer or its authorized agents, or (iv) installation, alteration, or repair of the Product by anyone other than AVer or its authorized agents.

### Disclaimer of Warranty

EXCEPT AS EXPRESSLY PROVIDED OTHERWISE HEREIN AND TO THE MAXIMUM EXTENT PERMITTED BY APPLICABLE LAW, AVER DISCLAIMS ALL OTHER WARRANTIES WITH RESPECT TO THE PRODUCT, WHETHER EXPRESS, IMPLIED, STATUTORY OR OTHERWISE, INCLUDING WITHOUT LIMITATION, SATISFACTORY QUALITY, COURSE OF DEALING, TRADE USAGE OR PRACTICE OR THE IMPLIED WARRANTIES OF MERCHANTABILITY, FITNESS FOR A PARTICULAR PURPOSE OR NONINFRINGEMENT OF THIRD PARTY RIGHTS.

### Limitation of Liability

IN NO EVENT SHALL AVER BE LIABLE FOR INDIRECT, INCIDENTAL, SPECIAL, EXEMPLARY, PUNITIVE, OR CONSEQUENTIAL DAMAGES OF ANY NATURE INCLUDING, BUT NOT LIMITED TO, LOSS OF PROFITS, DATA, REVENUE, PRODUCTION, OR USE, BUSINESS INTERRUPTION, OR PROCUREMENT OF SUBSTITUTE GOODS OR SERVICES ARISING OUT OF OR IN CONNECTION WITH THIS LIMITED WARRANTY, OR THE USE OR PERFORMANCE OF ANY PRODUCT, WHETHER BASED ON CONTRACT OR TORT, INCLUDING NEGLIGENCE, OR ANY OTHER LEGAL THEORY, EVEN IF AVER HAS ADVISED OF THE POSSIBILITY OF SUCH DAMAGES. AVER’S TOTAL, AGGREGATE LIABILITY FOR DAMAGES OF ANY NATURE, REGARDLESS OF FORM OF ACTION, SHALL IN NO EVENT EXCEED THE AMOUNT PAID BY YOU TO AVER FOR THE SPECIFIC PRODUCT UPON WHICH LIABILITY IS BASED.

## Governing Law and Your Rights

This warranty gives you specific legal rights; You may also have other rights granted under state law. These rights vary from state to state.



For warranty period, please refer to the warranty card.

---