

Cisco StackPower: Efficient Use of Power

Introduction

The Cisco StackPower™ technology is an innovative feature that aggregates all of the available power in a stack of switches and manages it as one common power pool for the entire stack. It is one of the main features introduced in the Cisco® Catalyst® 3750-X Series Switches (Figure 1).

Figure 1. Cisco StackPower



This white paper explains how Cisco StackPower manages power more efficiently, allowing customers to achieve more granular control of their power use and to realize savings that reduce the total cost of ownership (TCO) of their Cisco Catalyst switches.

This Whitepaper covers the following topics:

- Benefits of Cisco StackPower
- Technology Overview
- Use Case for Cisco StackPower
- Intelligent Power Management
- Cisco StackPower Topology
- Modes of Operation
- Intelligent Load Shedding
- Best Practices

Benefits of Cisco StackPower

The benefits of the Cisco StackPower technology are immediately tangible, and so are the savings.

Consider a stack of switches with each switch requiring a slightly higher power budget for some extra Power over Ethernet (PoE) devices randomly scattered in the stack. Purchasing extra second power supply for each switch that needs some additional power would be inefficient and expensive. With the Cisco StackPower solution, a common pool of power is made available and additional power can be automatically redirected to the appropriate switch based on the available power budget in the common power pool.

Cisco StackPower technology immediately produces savings by reducing the number of power supplies required per switch and the number of outlets required in the wiring closet. Additional savings accrue from minimizing energy wastage due to inefficiency of power supply operation at lower loads and reduction in cooling requirements in the wiring closet. Cisco StackPower also eliminates the need for external power shelves, thus freeing up additional space and power outlets in the wiring closet.

Cisco StackPower also allows the deployment of larger power pools by using an eXpandable Power System (XPS 2200). This system allows for a star topology which shares power with up to 9 switches. See Cisco StackPower Topology section.

Cisco StackPower technology provides the following additional benefits:

- Abstracts the location of a power supply from its physical location in a stack of switches, allowing for better utilization of available power capacity
- Maximizes the efficiency of power supplies - aggregated loads allow power supplies to operate at optimum efficiency, considerably reducing power supply wastage over time
- Provides or complements the power required for PoE+ to any port in a stack
- Enables a scalable PoE+ infrastructure
- Offers a pay-as-you-grow architecture, similar to the Cisco StackWise® technology
- Offers improved reliability, availability, and efficiency via the eXpandable Power System (XPS) to up to nine switches
- Enables a “zero-footprint” redundant power system (RPS)
- Offers greater redundancy, 1+N vs. 1:N redundancy with RPS
- Allows off-lining of power supplies when extra capacity is available in the system
- Helps achieve a higher mean time between failures (MTBF) due to improved efficiency
- Lowers TCO by reducing the number of power supplies needed, the number of devices in the rack, the amount of heat in the wiring closet, and the number of AC outlets required in the wiring closet

Technology Overview

The key aspect to the new Cisco StackPower technology is the way power is supplied and distributed to a switch in the stack. A switch requires power to be provided at different voltage levels, such as 5V DC and 48V DC, and a traditional power supply provides those voltages. These requirements make the power supply more complex, and this complexity affects efficiency.

Cisco StackPower technology implies a new approach to power supply design and power distribution in a switch, but its effects are most significant in a stack of switches.

The Cisco Catalyst 3750-X and 3560-X Series Switches are designed for power supplies that provide a single power voltage. This approach simplifies the power supply design and allows aggregation of power, from power supplies in a single switch and across switches in a power stack. Cisco StackPower technology creates a pool of power that shares a common load consisting of all the switches in the power stack. This capability to manage power as share resource is unique to a stack of switches that can operate as a single unit. Therefore StackPower technology is available only on the Catalyst 3750-X switches.

Note that all power available in the power stack is combined into one single large pool of power, and the stack becomes a large single load to the power pool (Figure 2).

Figure 2. Cisco StackPower: One Power Pool, One Load

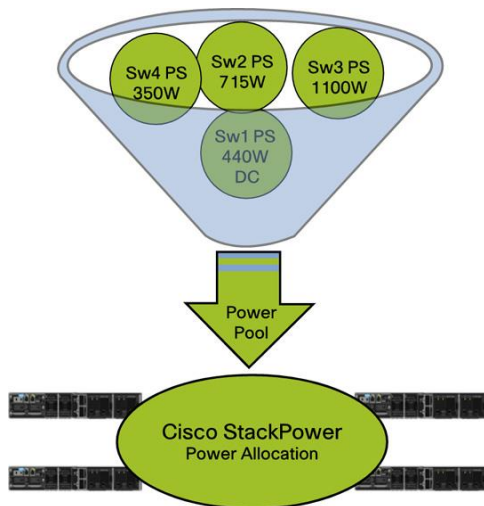

A surplus of power in a power stack enables features such as Zero-Footprint RPS and 1+N redundancy instead of the classic 1:N redundancy with dedicated external RPS.

Redundancy with Cisco StackPower is better because the redundant power is already inline (1+N), as opposed to being switched from one source to another, as in a classic RPS (1:N). The 1+N) redundancies are less susceptible to problems because the power is already available inline.

StackPower operation

Switches deployed in a power stack discover each other and exchange messages to figure out how much power is available in the stack (power budget), to set priorities (or use default priority values), and to start booting Cisco IOS® Software on all switches, depending upon the power budget available in the stack.

The boot-up sequence of events is as follows:

1. Switches are interconnected in a ring topology and power is applied.
2. All switches power up their Stack Power infrastructure (50W each, 42W in initial IOS release 12.2(53)SE2).
3. All switches participate in the power stack, exchange discovery packets, information messages regarding power resources and priorities.
4. The total budget in the power stack is discovered.
5. The power stack reserves 30W (42W in initial IOS release 12.2(53)SE2) in case a new member is dynamically added to the stack. This amount is reserved once per stack, not per switch (unless there is only one switch in the stack).
6. Budgets are distributed based on total power budget, power draw requirements, and switch priorities.
7. Switches that receive an allocation of power proceed to boot the Cisco IOS Software.
8. Switches that did not receive a power allocation will remain in the power stack without booting until more power is added to the power budget.

Cisco Catalyst 3750-X and 3560-X Series Switches do not consume more power than the rest of the Catalyst 3750 family of switches, but the power budget required is higher. This higher budget allows each switch to budget enough power for the switch itself, to power a high power network module (if present), and to power its downstream neighbor's StackPower logic (MCU), which is the minimum number of components in a switch to form a power stack without booting Cisco IOS Software.

The following table shows the power budget requirement for each 3560-X and 3750-X model

Table 1. Power Budget requirements for Cisco 3560-X and 3750-X Catalyst switches

Product ID	Power Budget Requirement
WS-C3560X-48 WS-C3560X-48P WS-C3750X-48 WS-C3750X-48P	223W
WS-C3560X-24 WS-C3560X-24P WS-C3750X-24 WS-C3750X-24P	190W
WS-C3750X-12S	192W
WS-C3750X-24S	230W

Note that with initial IOS release 12.2(53)SE2 all models had a power budget requirement of 206W.

For example, a standalone Cisco Catalyst 3750-X-48P switch (Figure 3) budgets 223W, this budget does not necessarily reflect the actual power consumption (see the data sheet for details).

Figure 3. Cisco Catalyst 3750-X-48P



Adding a new switch to a power stack

Cisco StackPower technology adds resiliency to the stack by reserving an amount of power enough to bring up the MCU of any Catalyst3750-X Series switch. This helps ensure that if and when a new switch without any power supplies is added to the power stack and does not have any power, it can join the power stack using the power that has been reserved for that purpose. This guarantees the inclusion of a new switch in the power stack; if the power stack has enough power in the power pool, Cisco StackPower will allocate power to the new switch to boot Cisco IOS Software.

Zero-Footprint RPS

The ability to provide redundancy without the need for an actual RPS is called Zero-Footprint RPS. The power stack discovers the members of the stack, aggregates power from all available sources in the stack, and subtracts from the power pool an amount of power equal to the largest power supply in the stack. It does not subtract the power supply itself nor it turn off any power supply.

In the simplest example, a power stack is formed by using a special cable to connect switches to each other to form a closed ring, similar to the topology for a Cisco StackWise stack (Figure 4). Up to four switches can be part of a power stack in a ring topology, and up to nine switches can share power in a star topology by using an eXpandable Power System (XPS) (Figure 5). Current flows through the cables that form the power stack and feed switches in need of power or complements power requirements of other switches in the stack. It is a safe system with plenty of circuit breakers spread around the printed circuit board to cut off current to different components in the system or if needed, to the system itself.

Figure 4. Ring Topology

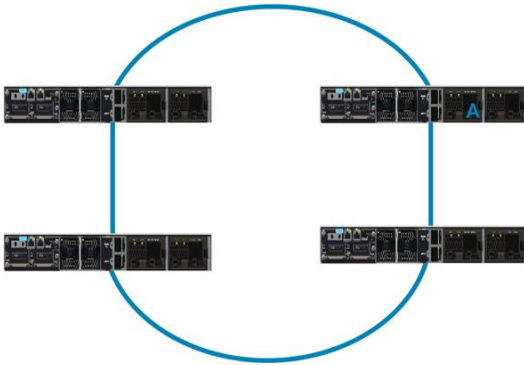

Figure 5. Star Topology, Using an XPS



The Cisco StackPower cables are thick but flexible, and they carry power as well as a data signal to provide a communications channel among the switches in the power stack. Table 1 shows Cisco StackPower and XPS Cables.

Table 2. Cisco StackPower and XPS Cables

Product ID	Description
CAB-SPWR-30CM	30cm StackPower cable
CAB-SPWR-150CM	150cm StackPower cable
CAB-XPS-58CM	58cm Short XPS cable
CAB-XPS-150CM	150cm Short XPS cable

StackPower and XPS cables are keyed and have colored bands on the ends to help you understand what cable plugs into what switch or XPS.

A StackPower cable has colors bands on the cable ends, green on one end and yellow on the other end. This cable can be used between Catalyst 3750-X switches and an XPS. Note that the connector with the blue band can only connect into a Catalyst 3750-X switch while the connector with the yellow band can connect to a Catalyst 3750-X or an XPS.

An XPS cable has a color band on the cable ends as well, red on one end and yellow on the other end. This cable can only be used to connect Catalyst 3750-X or 3560-X switch to an XPS. Note that the connector with the red band can only connect to an XPS while the connector with the green and blue band can connect to Catalyst 3750-X or 3560-X switch.

The Cisco Catalyst 3750-X Series Switches come with four power supply options and any of them can be used on any switch in a stack and in any combination. Table 2 lists these options.

Table 3. Power Supply Options for the Cisco Catalyst 3750-X Series Switches

Product ID	Description
C3KX-PWR-350WAC	350W AC power supply
C3KX-PWR-715WAC	715W AC power supply
C3KX-PWR-1100WAC	1100W AC power supply
C3KX-PWR-440WDC	440W DC power supply

The following are some important concepts for Cisco StackPower technology:

- The Cisco StackPower feature is responsible for the negotiation and distribution of power from a common power pool among the switches participating in the power stack.
- The intelligent load shed is a mechanism used by Cisco StackPower to decide what devices must power down when the available power drops below the allocated power levels. A priority scheme is used to set different levels which become useful when:
 - Load shedding in case the power budget falls below the allocated power levels.
 - Initial allocation of power to boot up into Cisco IOS SoftwarePriorities for powered devices and switches can be changed to values other than the pre-configured default values.
- Physical placement of power supplies in a switch is independent of the power required for that switch.
- A switch may not be allowed to boot up with Cisco IOS Software if all available power in the common pool has been already allocated. But this switch continues to participate in the power stack while waiting for more power to become available to allow it to boot.
- The power stack reports all of the Cisco StackPower information to the stack master; therefore, configuring a power stack that spans multiple data stacks is not recommended (see the “Best Practices” section).

Use Case for the Cisco StackPower Feature

Figure 6. Power Stack of Four Switches

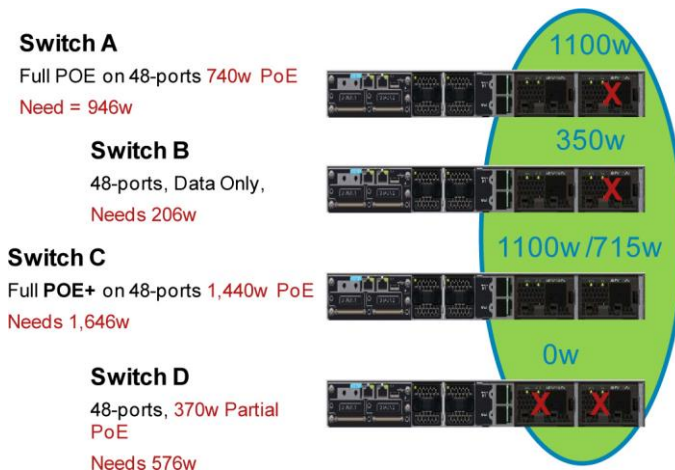

The following use cases will help you understand the Cisco StackPower technology and its main features.

Switches A, B, C, and D have the following configuration and power draw requirements¹:

- Switch A requires 946W to provide full PoE on all of its 48 ports. It has only one 1100W power supply; extra power capacity of 154W is available.
- Switch B requires 206W, since it is a non-PoE switch. It has only one 350W power supply; extra power capacity of 144W is available.
- Switch C requires 1646W to provide 1440W of full PoE+ on all 48 ports. It has one 1100W and one 715W power supply; extra power capacity of 169W is available.
- Switch D requires 576W to provide partial PoE on some ports. This switch does not have any power supply, requires 576W of power.

These switches have been cabled up to form a power stack in order to make use of unused power from switches with lower power requirements. This is the key benefit of Cisco StackPower technology, flexible use of available resources.

Let's summarize the scenario:

```
Power requirements for the power stack
Switches A - D = 946W+206W + 1646W+ 576W =3374W
Available power in the common pool of power stack
Switches A - D= 1100W+ 350W+1100W+715W = 3265W
Deficit power = -109W
```

¹ In this example, IOS release 12.2(53)SE2 is used, therefore the power budget required by each switch is 206W. In subsequent IOS releases, power budget requirement values vary with the switch model and are reported in Table 1.

Although the power stack in the example has extra capacity that gets in the power pool, it is not sufficient to power the switch D and PoE devices attached to it. To get the system in balance and to have a positive power budget, we must add more power to the stack; a 350W power supply will solve the problem but it must be installed in slot A of switch D (see the “Best Practices” section). With the addition of a 350W power supply we can make the power budget positive and have additional 241W left over in case more power is required by switch B or switch D.

Cisco StackPower technology provides us the ability to share and redirect surplus power from switch C to switch D, which does not have any power supply. Note that switch D even boots up without a power supply, since the StackPower allocates and directs power to it.

Cisco StackPower also has the ability to provide redundancy without the extra rack-unit in the rack. By adding one 1100W power supply to any of the open slots in the power stack, you can configure reserved power to be used in case of the failure of any power supply in the stack. This feature is called Zero-Footprint RPS.

Displaying Cisco StackPower Information

The Cisco IOS Software command-line interface (CLI) can be used to view Cisco StackPower details in terms of configured mode, StackPower port status, neighbor information, and power requirements as well as default and configured priorities.

“show stack-power”

Power stack name: Powerstack-1

```
Stack mode: Power sharing strict
```

Switch 1:

```
Power budget: 1646
Low port priority value: 27
High port priority value: 26
Switch priority value: 4
Port 1 status: Not shut
Port 2 status: Not shut
Neighbor on port 1: 0022.bdcf.9200
Neighbor on port 2: 0000.0000.0000
```

Switch 2:

```
Power budget: 206
Low port priority value: 19
High port priority value: 18
Switch priority value: 3
Port 1 status: Not shut
Port 2 status: Not shut
Neighbor on port 1: 0000.0000.0000
Neighbor on port 2: 0022.bdd0.6680
```

The “show env” command can complement the information to obtain the available power sources in the stack. Notice in the output below, switch 1 only has one 1100W power supply and switch 2 has one 1100W in slot A and one 715W in slot B.

“show env power all”

SW	PID	Serial#	Status	Sys Pwr	PoE Pwr	Watts
1A	NG3K-PWR-1100WAC	LIT1337057T	OK	Good	Good	1100/0
1B			No Input Power	Bad	N/A	235/0
2A	NG3K-PWR-1100WAC	LIT13370597	OK	Good	Good	1100/0
2B	NG3K-PWR-715WAC	LIT133705CC	OK	Good	Good	715/0

Intelligent Power Management

Placing all of the available power in a single pool has advantages: a load (the switches in the power stack and their respective power-able devices) is applied to the pooled power, making an efficient use of the power resources of the stack. An administrator may conclude that there is too much power available in one stack and may decide to take a power supply offline or pull it out and deploy it somewhere else.

A traditional power supply reaches around 80 percent efficiency when the applied load reaches around 60 percent and tops out at a load of perhaps 80 percent; therefore, to make the best possible use of power, it is a good idea to apply all of the load to a single power supply to reach higher efficiency more quickly before powering up a second power supply and so on. Figure 7 shows the efficiency curve of three switches compared to the efficiency curve of one switch with an optimal load.

Figure 7. Efficiency Curves

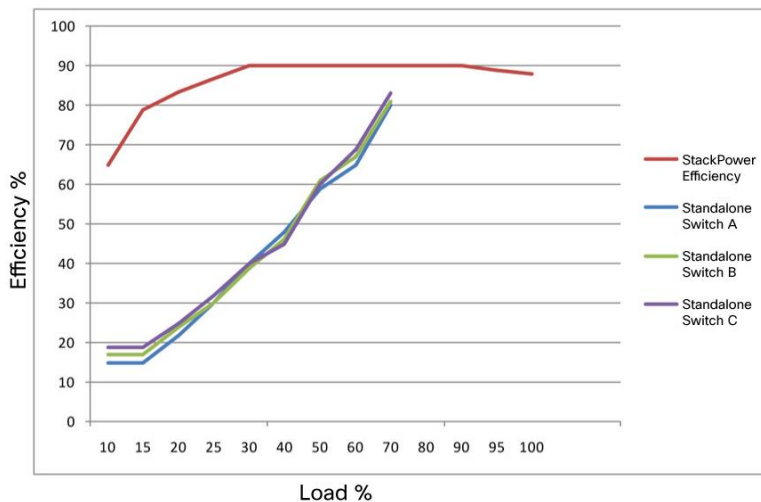

These efficiency curves belong to three different switches, each drawing different loads from their power supply and none of them reaching 60 percent load, which increases the amount of energy wasted.

A more energy-efficient scenario could involve the same three switches drawing power from the same source, as in a power stack. Three switches have a higher chance to reach the optimal load on the power supply, so the maximum efficiency can be reached sooner, translating into energy savings and more intelligent use of power. Note that Cisco IOS Software has the knobs to take a power supply offline and place it back online as required, and the Cisco StackPower feature has the instrumentation to provide the information needed to take an action, but off-lining a power supply requires administrator intervention.

A maximum of 8400W is possible in a pool of power in a stack of four switches loaded with two 1100W power supplies each. Obviously, it is excessive; even if the stack consists of four Catalysts 3750-X-48P switches requiring full PoE+. Let's do the math:

```
4 switches x 48 ports x 30W = 5760W: a lot less than the available 8400W
```

If only one power supply is installed in each switch, we get 4200W in the power pool. Now we fall short, but the reality is that not everyone needs full PoE+ on every port in a stack of four switches; hence, 4200W may be just fine. Here is where the Cisco StackPower feature starts to provide savings by allowing the administrator to purchase power supplies as the need for power grows.

Cisco StackPower Topology

The Cisco StackPower technology can be deployed in a ring topology as well as in a star topology over an XPS, as shown earlier in Figures 4 and 5. Both topologies have advantages; a ring topology provides greater resiliency, since current can flow in either direction in the ring in case of a path failure. On the other hand, the number of switches sharing power is restricted to four. To ensure safety and prevent large currents through the cables, the number of switches in a power stack is limited to four; some deployment scenarios create large currents that would require a larger gauge wire in the StackPower cables which reduces the manageability of the cables. Nonetheless, a stack of four is a common deployment.

In a star topology, there is no such restriction; all nine switches can share power through the XPS, although one more piece of hardware is installed in the rack among the switches.

eXpandable Power System (XPS 2200)

The XPS 2200 is the next-generation power redundant system, providing redundancy for up to nine Cisco Catalyst 3560-X Series Switches as well as Cisco StackPower capability to up to nine Catalyst 3750-X switches.

Modes of Operation

Cisco StackPower technology has three modes of operation, which offer new capabilities as well as the classical RPS functionality without the RPS device. The three modes of operation are:

```
Power-sharing mode, strict and non-strict (loose)
Redundant mode, strict and non-strict (loose)
RPS mode (requires an XPS 2200)
```

Power-Sharing Mode (Non-strict or loose)

The default configuration is power-sharing mode non-strict. Of course, you have the option of configuring strict mode, which would keep you from creating a negative power budget. The same is true for redundant mode.

Power sharing mode is the core of StackPower and is the simplest (Figure 8). The power gets allocated from the power pool as power requests come in from the switches and PoE devices (IP phones, wireless access points, and so on). The power stack keeps track of the power budget and allocated power count and continues to allocate new power until the power budget is completely depleted. By default, this mode does not have any restrictions and will allocate all the power available in the power budget.

Figure 8. Power Share Mode

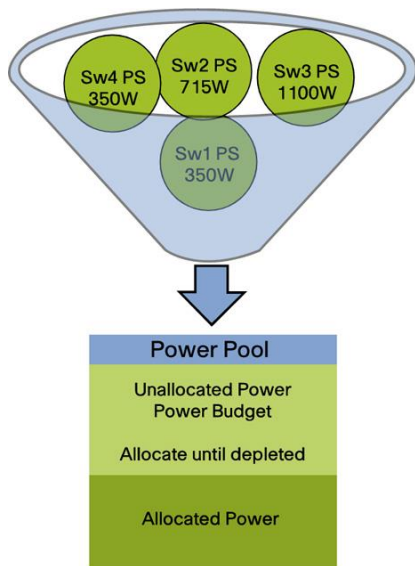

In the following scenario, the Cisco StackPower technology aggregates three power supplies on four switches (1100W + 1100W + 1100W + 0W = 3300W). The load requirement is 500W per switch (500W + 500W + 500W + 500W = 2000).

Figure 9. Power sharing among 4 Switches

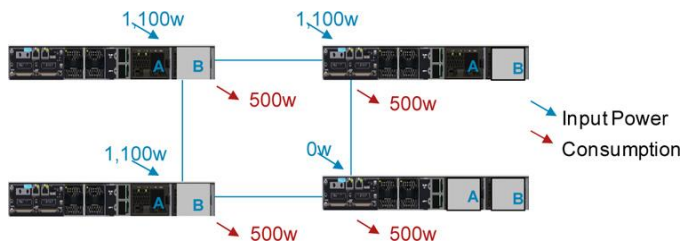

Power budget is 3300W
 Allocated power is 2000W
 Available unallocated power is 1300W

Should power requirements increase in any of the switches of the power stack, the Cisco StackPower feature can redirect power from the unallocated power pool to any port in any switch in the stack; power can be drawn from the unallocated pool until it is completely depleted. Once the power budget is depleted, all power requests will be denied.

Notice that not all switches have a power supply. StackPower is capable of sharing power even with switches that don't have a power supply.

Power Share “Strict” Mode

The power sharing mode has an inherent capability to oversubscribe itself in case of power supply failures. That is, when an imbalance occurs between available power budgets and allocated power, more power is allocated than is available. By definition, the system should never have a negative power budget, but it is possible that a power supply failure brings the power budget below the allocated power. Such a condition will trigger a series of alarming messages to the console.

$$\text{Negative budget} = \text{Available power} < \text{Allocated power}$$

The problem is that a demand for previously allocated (negotiated) power may come at any moment, and there may not be enough power available to respond to the previously committed resource.

Cisco StackPower technology has a “strict” mode to keep you from getting into that situation. This mode forces the power stack to stay in a positive budget; that is, when a power supply failure causes this condition, the power stack begins shedding power according to preset priority levels until the available power is equal to the allocated power.

Redundant Mode

Redundant mode (Figure 10) reserves an amount of power for redundancy from the power pool and guarantee operations in case of a single power supply failure in the power stack. The reserved power is equal to the size of the largest power supply in the stack. The rest of the power in the power pool is used as in Power-sharing mode and the strict and non-strict modes work exactly the same as in power-sharing modes.

Figure 10. Redundant mode

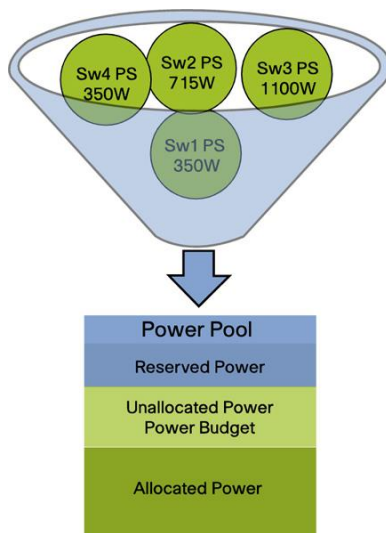

The largest power supply in the stack is not reserved; instead an amount of power equal to the capacity of the largest power supply in the stack is set aside as reserved power. In case of a power supply failure, the entire power reserve is made available to the budget, ready to be allocated. Note that regardless of which type or size of power supply has failed, the reserved power is used as a whole amount and cannot be fragmented.

It is important to note that the Cisco StackPower feature will not take any power supply offline automatically based on the power budget report. That is, a power stack could have a surplus of power capacity and redundancy configured, but it would not offline any power supply from the system. This action needs to be performed by an administrator of the power stack.

The following scenario is similar to the power-sharing mode in figure 9. The Cisco StackPower technology aggregates three power supplies (1100W + 1100W + 1100W + 0W = 3300W). The load requirement is 500W per switch (500W + 500W + 500W + 500W = 2000).

Figure 11. Redundant power

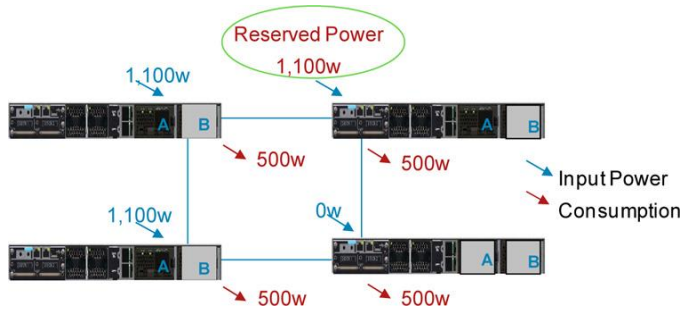

Power budget is 3300W

Reserved power 1100W (equal to the size of the largest power supply in the stack)

Allocated power is 2000W

Available unallocated power is 200W

Should power requirements increase in any of the switches of the power stack, the Cisco StackPower feature can redirect power from the unallocated power pool to any port in any switch in the stack; power is drawn from the unallocated pool (200W) until it is completely depleted. Once the power budget is depleted, all power requests will be denied.

If a power supply failure occurs, regardless of which size power supply, the entire amount of reserved power is now available to the power budget. This is 1+N vs. traditional redundant power systems 1:N with a dedicated external power system.

Advantage of this feature is that redundant power is already available online without any switching required which reduces the chance for failures during power switching from internal power supply to the external redundant system.

RPS Mode

RPS mode is supported only with the XPS. This is the traditional RPS-style support, where up to nine switches are connected to the XPS but only two can be actively backed up by the XPS at any one time. This is one-to-one backup: one power supply to one switch. This mode is not to be confused with redundant mode, in which an amount of power is reserved from the overall budget. RPS mode is the default and only mode for Cisco Catalyst 3560-X Series Switches.

Intelligent Load Shedding

Cisco StackPower feature enables intelligently managing not only a stack's power resources but also power failures.

Load shedding is the process of shutting down devices in case of power supply, cable, or system failures. For power stacks in power-sharing mode, there are two types of load-shedding: immediate and graceful.

Immediate load shed occurs when a failure could cause the power stack to fail very quickly, for example a massive power failure where multiple power supplies go offline for any reason and the available power cannot sustain the system.

Graceful load-shedding can occur when a power supply fails and forces the power stack to re-evaluate its power allocations. Switches and powered devices may shut down in order of their default or configured priority, starting with devices with priority 27, until the power budget matches the input power. Graceful load shedding is always enabled and immediate load shedding occurs only when necessary.

What is a balanced power stack?

A balanced power stack is one that has a positive power budget; in other words, the available power is equal to or greater than the allocated power.

Balanced power budget: Available power > Allocated power

When a power stack suffers a power supply failure, the available power budget drops, and if “strict” power sharing mode has not been configured, the result is a negative power budget, causing the system to become unbalanced.

Negative power budget: Available power < Allocated power

If the allocated power is not currently being consumed, nothing would happen other than IOS messages on the console, but as soon as the allocated power is demanded by PoE devices, the system will start a load-shedding process until the power budget is balanced again.

The design of the Cisco Catalyst 3750-X switches includes hardware to assign a priority to every port in the switch. This hardware allows us to tag ports for high and low priorities, which are set by default but can be programmed by the administrator. These priorities are used only when the switch or the stack needs to shed power to bring the system back into balance. Cisco IOS Software will generate plenty of console messages to inform the administrator about the situation.

Priority Scheme

StackPower has a priority scheme that covers up to nine switches in a data stack and all of the ports in the entire stack.

Priorities are set by default when the power stack gets created but you can configure the priority of a switch or powered device to receive power (Figure 12). This priority determines the order in which devices are shut down in case of a power shortage i.e. graceful load-shedding. You can configure three priorities per system: the system (or switch) priority, the priority of the high-priority PoE ports on a switch, and the priority of the low-priority PoE ports on a switch.

Figure 12. StackPower Default Priorities

Default StackPower Priorities																										
1	2	3	4	5	6	7	8	9	10	11	12	13	14	15	16	17	18	19	20	21	22	23	24	25	26	27
Switches									High Priority Ports									Low Priority Ports								

The Catalyst 3750-X has the capability to create two groups of ports, High priority and Low Priority (Figure 13). High priority ports are those connected to more important or critical powered devices and are preferred to retain inline PoE power in case of a power shortage. StackPower or the administrator assigns a priority level to those groups of ports.

The table shows the default priorities used by StackPower that can be overwritten by an administrator. As an example, a power stack can assign priority 2 to a switch-A, priority 10 to high priority ports, and priority 20 to low priority ports. Each switch in the stack will have a different priority set for the switch, high priority ports, and low priority ports respectively. The priority levels are not repeated on any switch or port. That is switch-A with has priority level 10 for its high priority ports and if load shedding is required, all other switches in the stack will have to shed off their low priority ports (priority 19-27) and their high priority ports (priority 11-18) before switch-A has to shed off PoE power on its high priority ports because it has the highest priority level (10) for high priority ports.

Figure 13. Load shed sequence

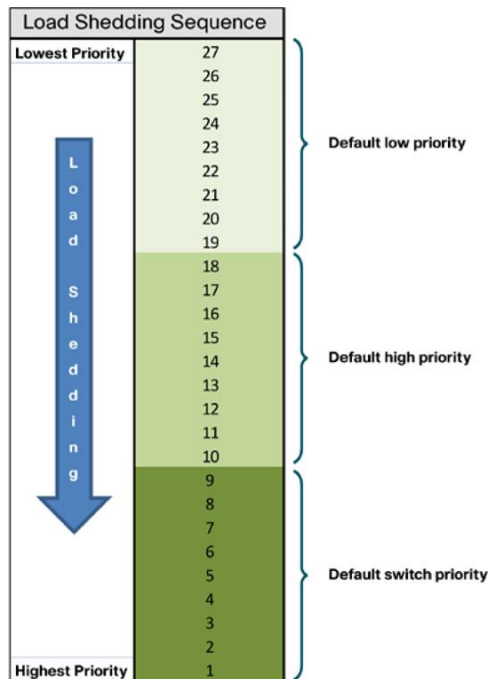

IOS has the capability to monitor administrator priority settings to make sure that a high priority port in Switch-A cannot have a lower priority level than a low priority port on another switch in the stack.

As an administrator you can select any priority level for your switches and devices as long as you keep the hierarchy of the switches, high priority ports, and low priority ports in such a way that a high priority port will not shed off before a low priority port.

Best Practices

Cisco StackPower is an innovative technology that allows for a flexible and efficient use of the power resources in a stack of switches; such an orchestration of hardware capabilities, resources, and features require us to follow certain practices to insure proper and better use of this technology.

Recommendations:

1. Deploy power supplies in a balanced manner, that is, spread larger power supplies across all switches in the stack or install larger power supplies on non-adjacent switches in the stack.
2. Also, fill in slot A of all switches in the stack before installing a power supply in slot B of any switch.

Power supply slots are named left to right, that is, power supply slot A in on the left and power supply slot B is on the right (closest to the edge of the switch).

This practice allows us to distribute power sources across all switches in the stack. Otherwise, a single failure in the power stack would cause larger power demands than what StackPower is designed to handle. Any switch can only share up to 2000W of power to a neighbor, whether the power is to be consumed by the neighbor or to be passed down to another switch in the stack.

Observe Figure 14 and note that switches on the right side source 20A but consume 80A of power. If a failure occurs on one of the connections between the right and left halves of the power stack, large currents would be requested via the alternate path. Cisco StackPower is designed to share up to 40A (2000W); this means that the system will start a load shed, which means an outage. The outage will depend on the amount of power required.

Figure 14. Unbalanced power stack

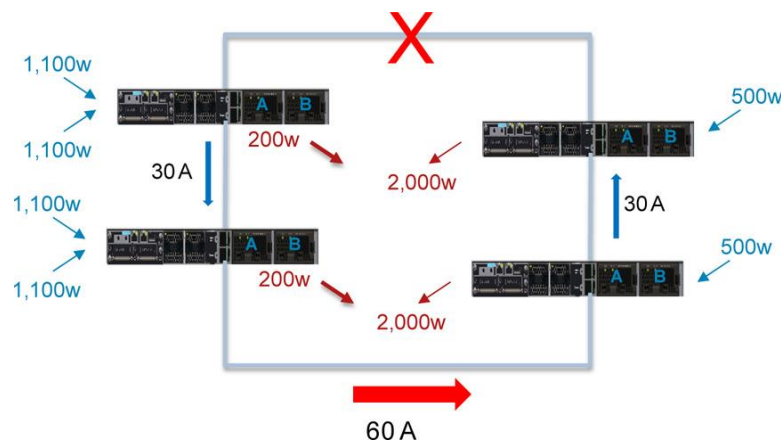

3. Do not configure power stacks that span across data stacks.
Cisco StackPower is limited to four switches per power stack although one stack of nine switches can be configured over multiple power stacks; this is a supported deployment. On the other hand, one power stack can also span over multiple data stacks although it is not recommended. It is not a recommended deployment because of display and control reasons. That is, StackPower reports the power budget, priorities, neighbor information, and similar parameters to the stack master; therefore having two stack masters would make management a nightmare. In this scenario, there would be two masters receiving information about the same power stack, that would confuse the administrator and would cause unexpected behavior in case of load sheds.
4. Configure strict modes and do not allow the power stack available power budget to go negative.
Strict mode is not the default for neither power-sharing nor redundant modes; hence the recommendation to configure strict mode to force the system shed loads as soon as the power budget falls below the allocated power even if the power is not needed at that precise moment.
5. Recommendation for changing Cisco StackPower modes.
Changing Cisco StackPower modes is possible without reloading the power stack. There is no need to reload neither the power stack nor any of its members; nonetheless caution must be exercised when deciding to switch from power-sharing mode to redundant mode. The reason is as follows: If the power budget is sufficient to sustain the power stack in power-sharing mode but it does not have enough power to support the redundant mode which requires enough extra power in the budget equal to the largest power supply in the power stack, it will cause a load shed of PoE devices and even switches in the power stack.

The recommendation is to perform the calculation of required power in the power stack and add the amount of reserved power (size of the largest power supply in the power stack) and compare the requirement with the available power in the power stack.

6. Off-lining power supplies are supported but it is not automatic.

Cisco IOS has the necessary commands to manage the power supplies and administrator intervention is required due to the multiple use cases that can be derived. Cisco IOS has multiple warning messages to prevent unbalancing the power stack.

Recommendation is to analyze the deployment to make sure that turning off a power supply would not break any of the rules or recommendations stated earlier such as filling in all power supply slot A before installing a power supply in slot B; turning off a power supply would have a similar effect of removing the power supply from.

For More Information

Refer to following documents:

Catalyst 3750-X Software Configuration Guide

Catalyst 3750-X Hardware Installation Guide



Americas Headquarters
Cisco Systems, Inc.
San Jose, CA

Asia Pacific Headquarters
Cisco Systems (USA) Pte. Ltd.
Singapore

Europe Headquarters
Cisco Systems International BV Amsterdam,
The Netherlands

Cisco has more than 200 offices worldwide. Addresses, phone numbers, and fax numbers are listed on the Cisco Website at www.cisco.com/go/offices.

Cisco and the Cisco logo are trademarks or registered trademarks of Cisco and/or its affiliates in the U.S. and other countries. To view a list of Cisco trademarks, go to this URL: www.cisco.com/go/trademarks. Third party trademarks mentioned are the property of their respective owners. The use of the word partner does not imply a partnership relationship between Cisco and any other company. (1110R)