

XRocker™

Infiniti



Wireless Pedestal Sound Rocker

User Manual Item no: 5106001

Need Help?

Email: service@xrockernation.co.uk **Phone:** 01274 683 109 **www.xrockernation.co.uk**

IMPORTANT: You must keep your original retail receipt as proof of purchase.



Thank you for purchasing the X-Rocker Infiniti! We know you will enjoy your X-Rocker experience as much as we do!

Get ready to experience sound as you never have before!



Box Contents

For Technical support please visit our website: www.xrockemation.co.uk/support

X-Rocker Infiti

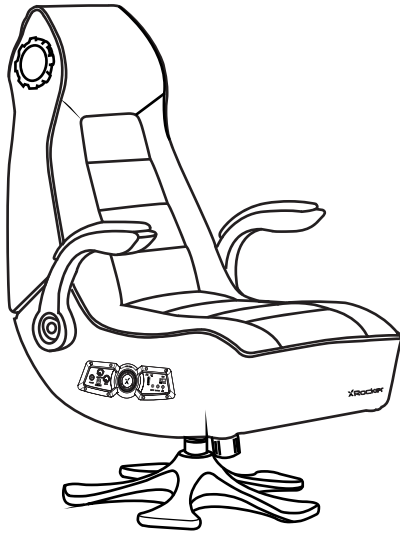

Wireless DAC

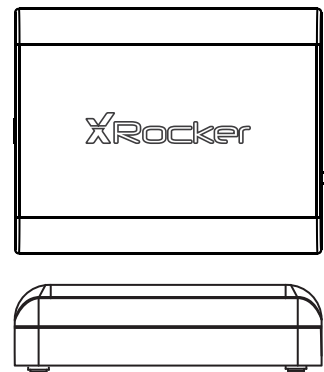

3.5mm Audio Cable

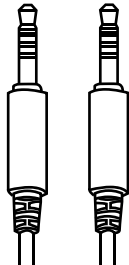

Female 3.5mm to male RCA Phono Cable

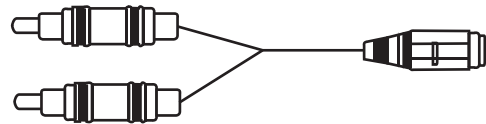

Main Power Adapter

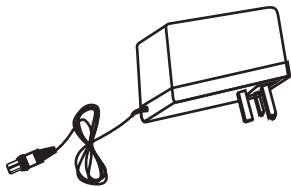

USB to micro USB

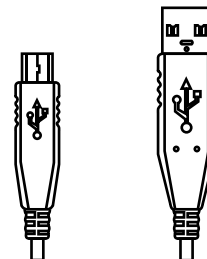

Optical Cable

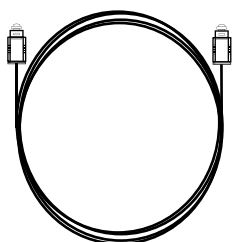

RCA Connectors × 2

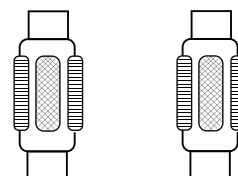

Table of Contents

About X-Rocker Infiniti.....	1
Parts and Controls.....	2
Setup	
Connect by USB (PS4™ Only)	3-4
Connect by optical (PS4™).....	5-6
Connect by optical (PS3™).....	7-8
Bluetooth.....	9
Wired.....	10
Troubleshooting tips.....	11
Important health and safety information.....	12
Warranty.....	13

About the X-Rocker Infiniti

This X-Rocker Infiniti gaming chair has all of the best gaming features rolled into a single unit. Featuring all new technology such as the dual wireless control panel which connects to both the new digital wireless transmitter for console play and Bluetooth for phone and tablet usage. The X-Rocker Infiniti also features a 2.1 stereo surround speaker setup, vibration and super comfortable arm rests and faux leather padding.



Dual Control Panel

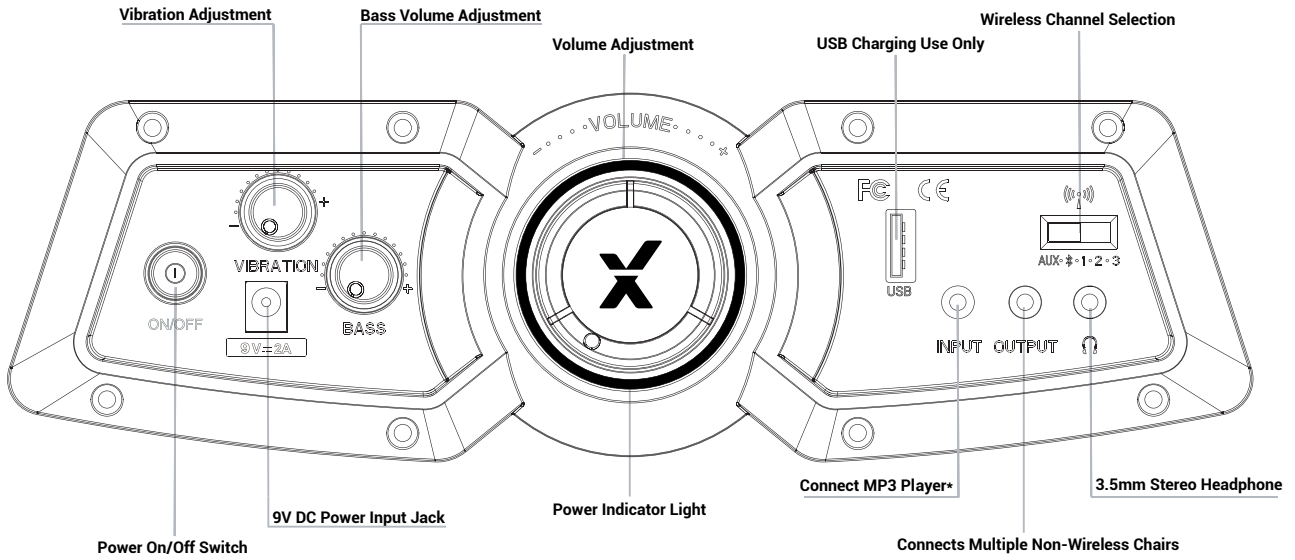

Wireless DAC

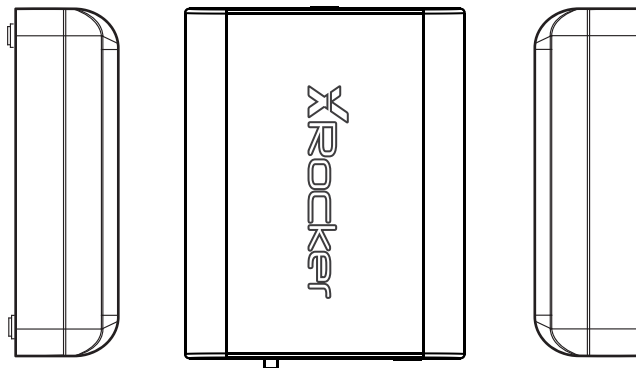
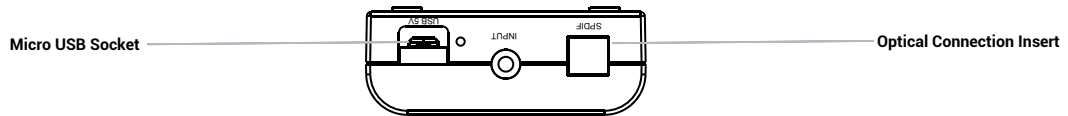

*MP3 player compatibility not tested nor endorsed by Sony Interactive Entertainment Inc

Support - Connect by USB (PS4™)

Step 1

Insert the micro USB cable into the X-Rocker DAC converter and the other end into one of the front USB ports on the PS4™ system.

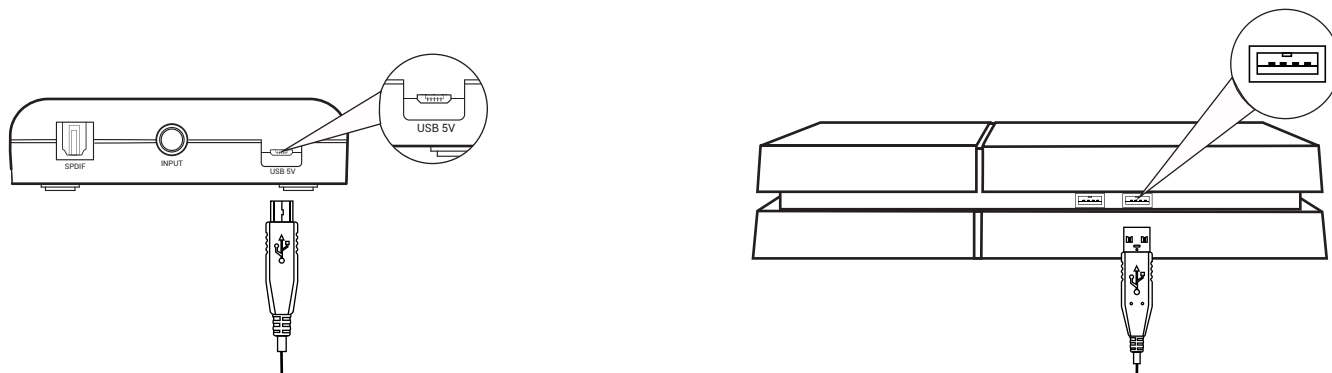

Step 2

Select one of the wireless bands (1,2,3) on the wireless DAC and then switch to the corresponding band on the chair.

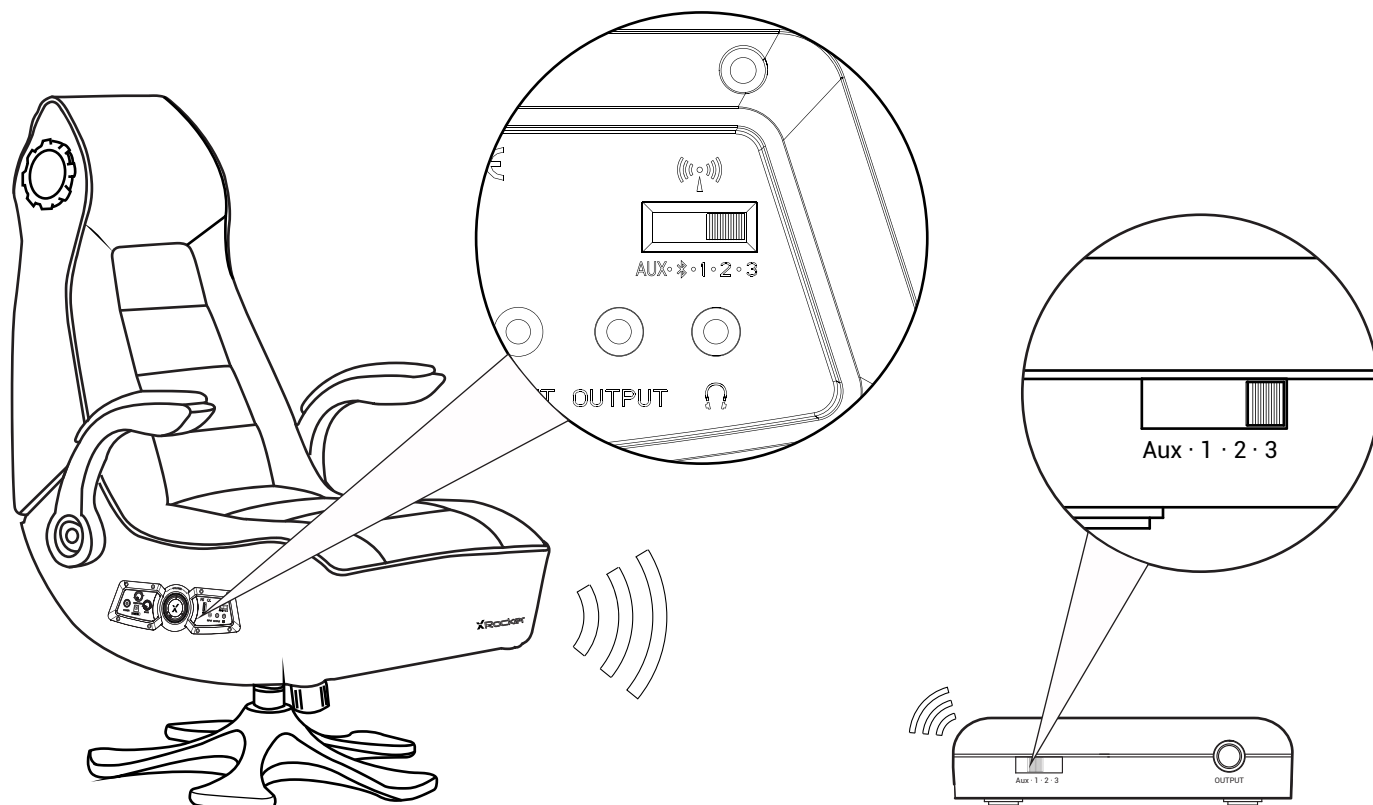

Support - Connect by USB (PS4™)

Step 3

On the main PS4™ menu screen select (Settings) > [Devices] > [Audio Devices] > [Output Device].

Step 4

Select [USB headphones] and change the setting in [Output to headphones] from [Chat audio] to [All Audio].

Save, exit and enjoy!

Support - Connect by optical (PS4™)

Step 1

Make sure that the PS4™ system is switched OFF. Insert the micro USB cable into the X-Rocker DAC converter and the other end into one of the front USB ports on the PS4™ system.

Remove the clear plastic covers from both ends of the optical cable.

Input one end of the optical cable into the X-Rocker Wireless DAC (Slot titled SPDIF) and the other into the Optical SPDIF connector on the PS4™ system.

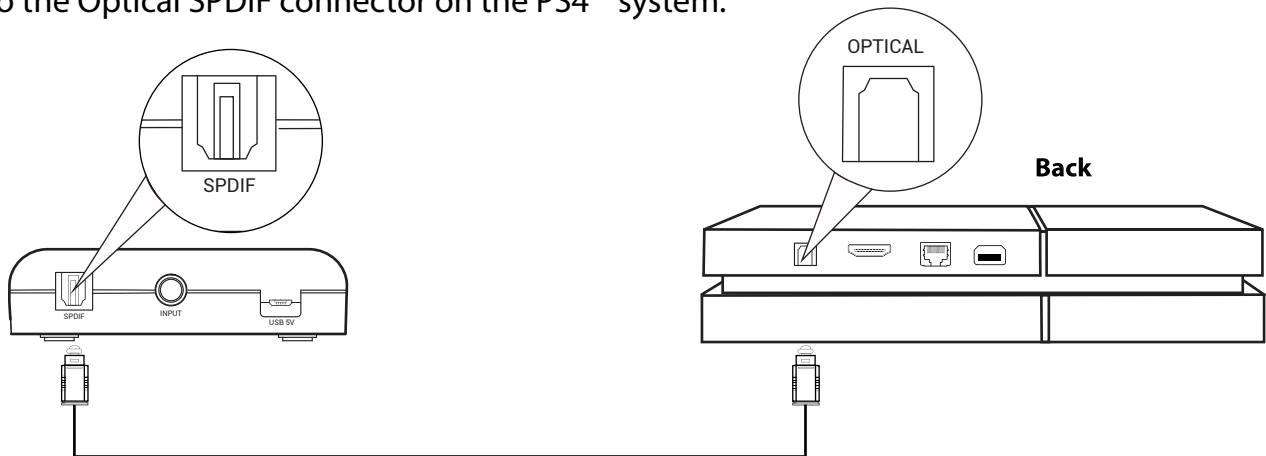

Step 2

Turn the PS4™ system back on. Select one of the wireless bands (1,2,3) on the wireless DAC and then switch to the corresponding band on the chair.

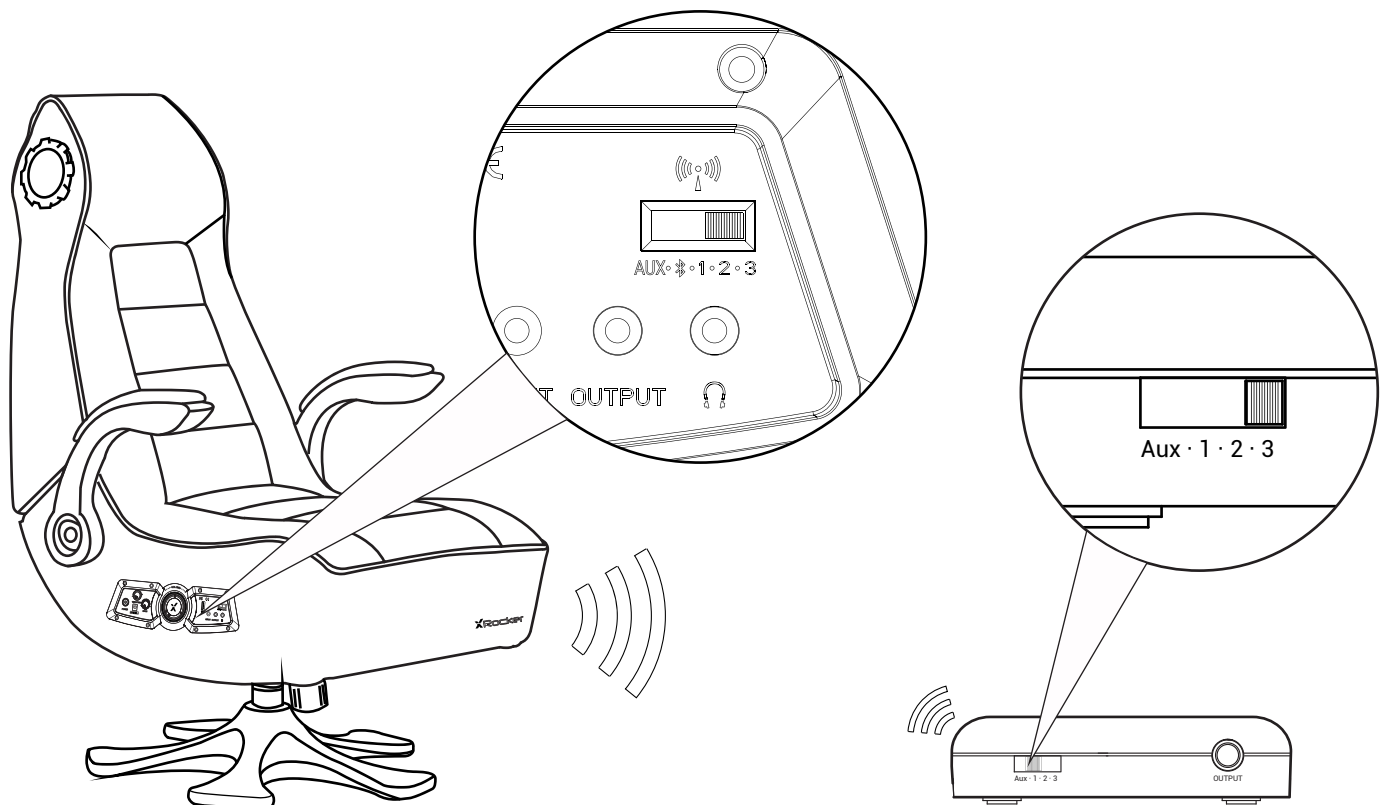

Support - Connect by optical (PS4™)

Step 3

On the main PS4™ menu screen Select (Settings) > [Sound and Screen] > [Audio Output Settings] > [Primary Output Port] Change this to [Digital Optical] > choose AAC.

Step 4

Go back to the Audio output menu, go to Audio format and make sure [Linear PCM] is ticked.

Save, exit and enjoy!

Support - Connect by optical (PS3™)

Step 1

Make sure that the PS3™ system is switched OFF. Insert the micro USB cable into the X-Rocker DAC converter and the other end into one of the front USB ports on the the PS3™ system.

Remove the clear plastic covers from both ends of the optical cable.

Input one end of the optical cable into the X-Rocker Wireless DAC and the other into the SPDIF connector on the PS3™ system.

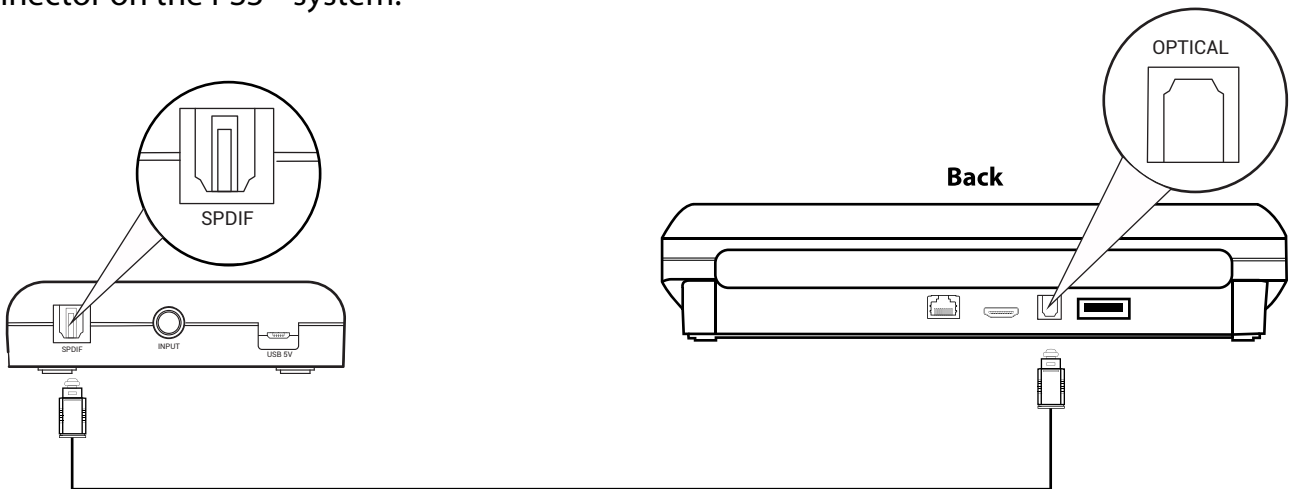

Step 2

Turn the PS3™ system back on. Select one of the wireless bands (1,2,3) on the wireless DAC and then switch to the corresponding band on the chair.

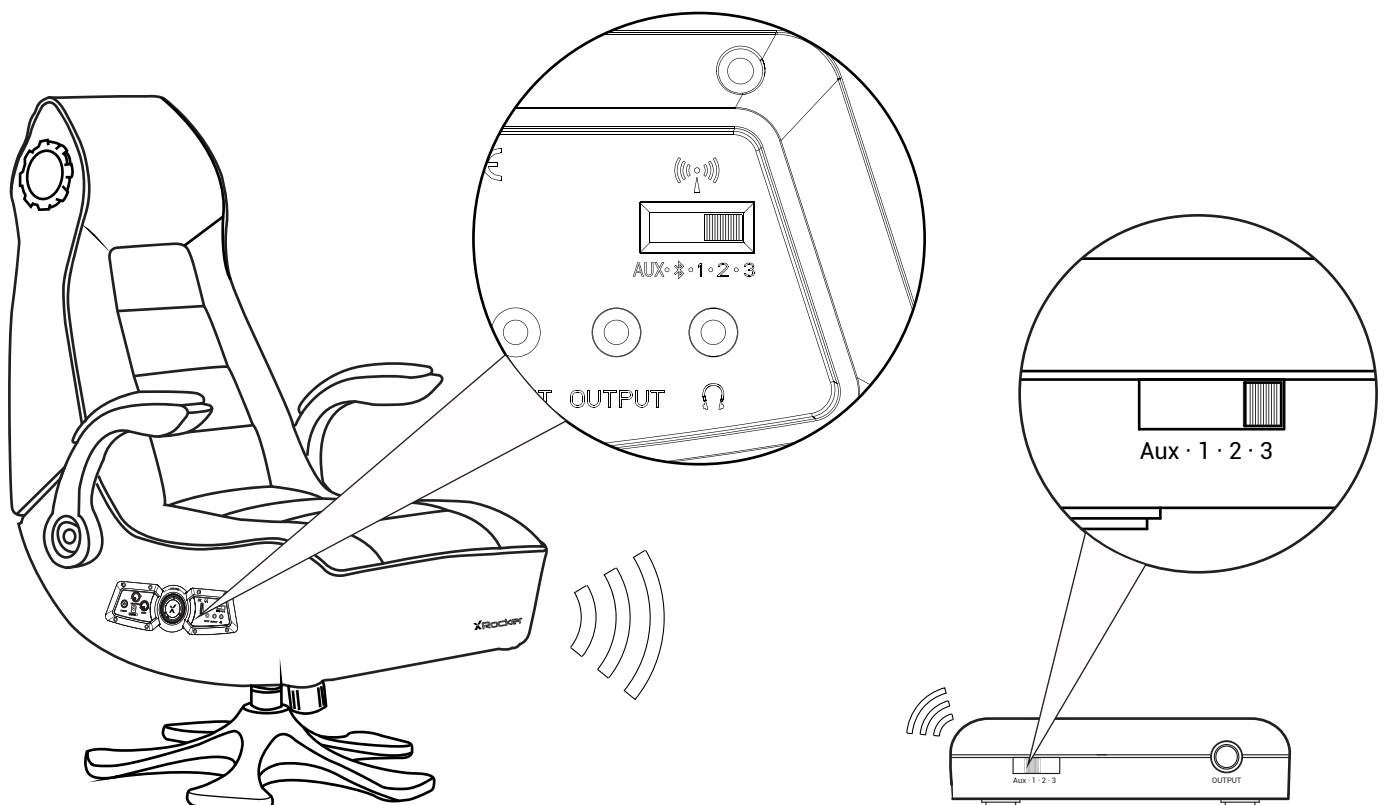

Support - Connect by optical (PS3™)

Step 3

On the main PS3™ menu screen Select [Sound Settings] > [Audio Output Settings]

Step 4

On the next menu select [Optical Digital] then navigate to the end of the menu to save.

Enjoy!

Support - Bluetooth

Step 1

Switch the X-Rocker Infiniti's wireless switch to the Bluetooth position.

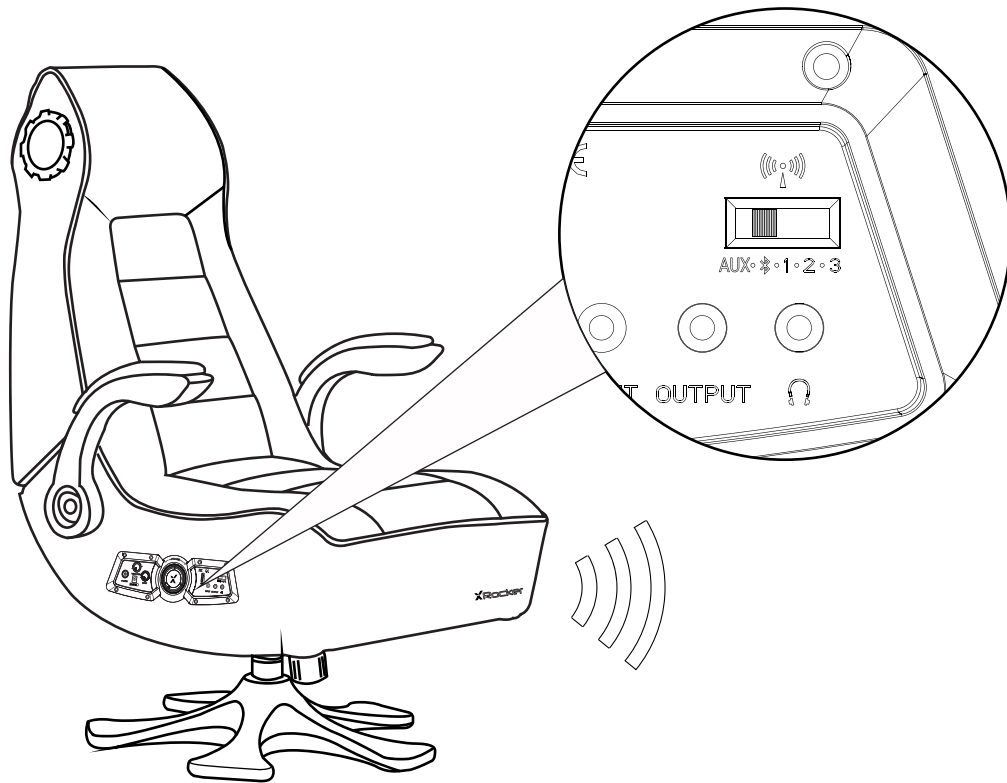

Step 2

On the Audio output device go into its Bluetooth settings, turn Bluetooth on if it is not on already and search for XROCKER. Upon finding this, select the XROCKER option. If a passcode is required the four digit code will be '0000'.



Enjoy!

Support - Wired (PS Vita)

Step 1

Switch the X-Rocker Infniti's wireless switch to the 'AUX' position.

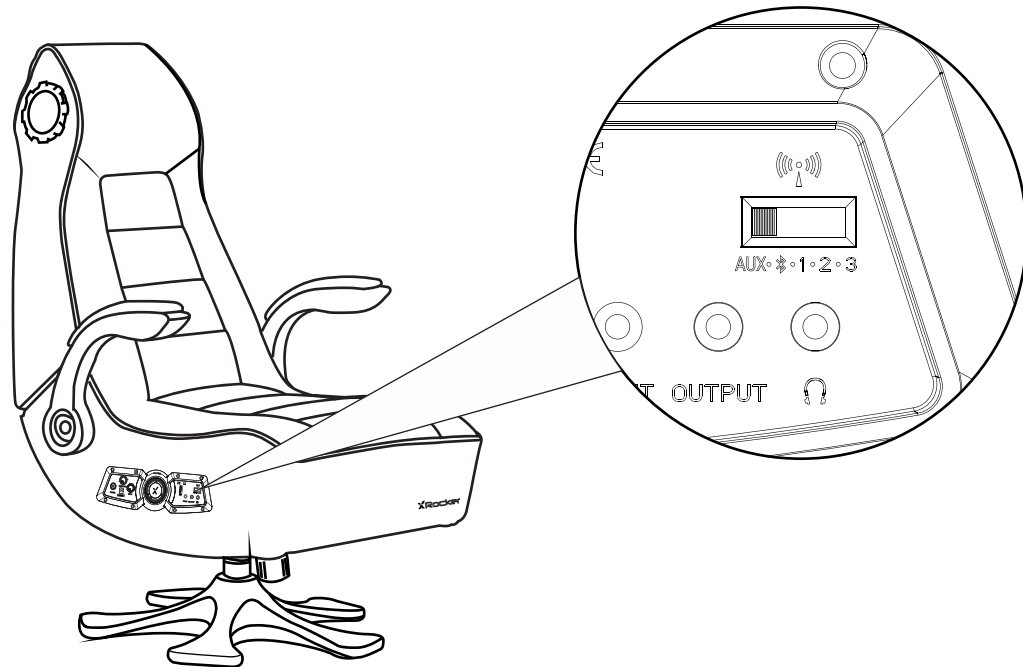

Step 2

Connect one end of the 3.5mm audio cable into the headphone socket on the chair then connect the other end to the headphone socket located on the PS Vita™.

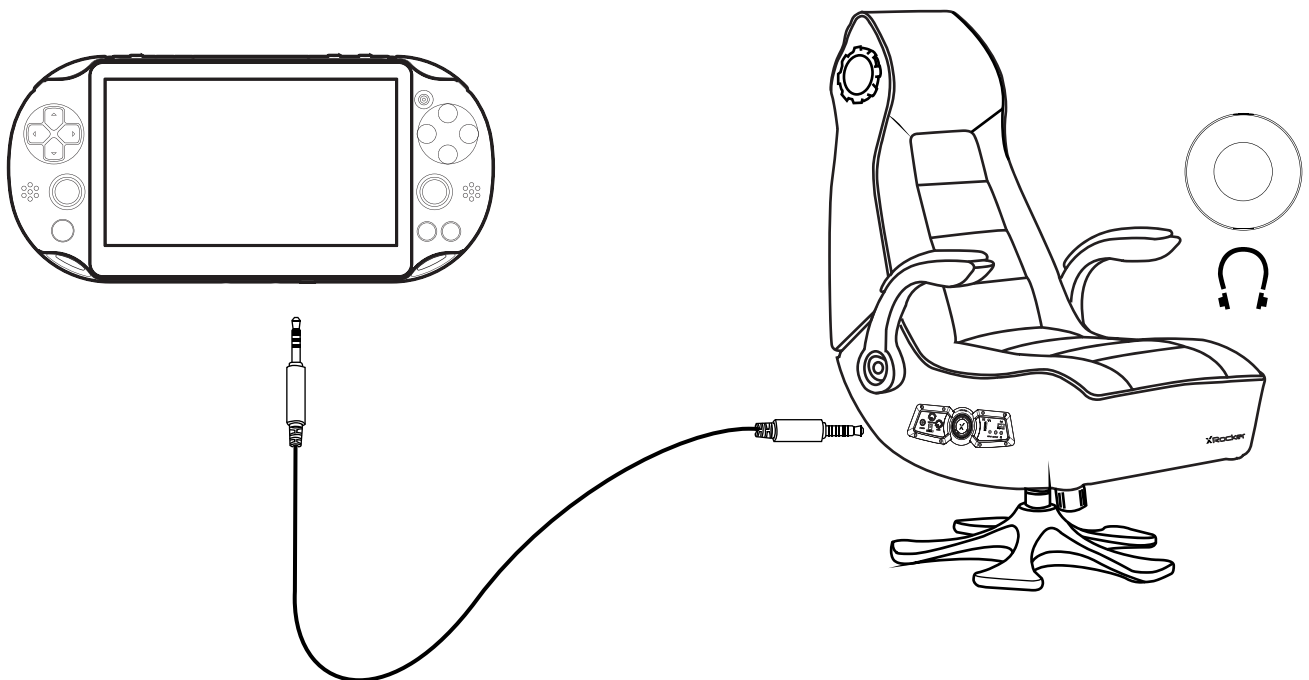

*The above steps can also be used to connect a Tablet, Phone, TV, Wireless DAC or MP3 player to the chair. Note: compatibility and use with these devices is not tested nor endorsed by Sony Interactive Entertainment Europe.

Enjoy!

Troubleshooting

Issue	Problem
No power going to control panel	<ul style="list-style-type: none"> • Make sure that the power cable is connected correctly. • Make sure that the power supply at the power source is working correctly. • With the chair turned to the ON position, give the power cable a slight wiggle in the port. If any lights flicker (or not) then please contact support (details below).
No sound	<ul style="list-style-type: none"> • Review the connection methods on the previous page and try alternative connection methods if possible. • Confirm that the device/system is correctly configured as per previous connection guide. • Make sure that the wireless channel switcher is in the corresponding position that suits your connection method. (1,2,3 for wireless, B for Bluetooth and AUX for wired connections).
Wireless transmitter cuts out during gameplay/ No vibration or subwoofer sound via analogue connection	<ul style="list-style-type: none"> • Please make sure that the volume of the source device is at a higher level to strengthen the wireless signal.
The cables connected to my X-Rocker have been broken accidentally	<ul style="list-style-type: none"> • Please contact X-Rocker support (www.xrockernation.co.uk/support) regarding this issue.
Bluetooth is not pairing with my mobile phone/ tablet device	<ul style="list-style-type: none"> • Turn the X-Rocker off and then make sure the X-Rocker is in Bluetooth mode. Press and hold the power button for five seconds to put the chair into pairing mode, this should now be discoverable. • Your device may be blocking the X-Rocker from connecting by way of passkey, if this occurs then the passkey is '0000'. • If this does not work straight away then please make sure that other nearby Bluetooth devices have been turned off. • Please note that the connection for sound from a PlayStation® system is via the provided USB Wireless DAC and not via Bluetooth.
Interference over wireless connection	<ul style="list-style-type: none"> • In this case, try another of the three wireless bands to isolate the signal.
Can I use more than one X-Rocker from a single sound source?	<ul style="list-style-type: none"> • Yes, simply tune the second X-Rocker to the same wireless band as the first to achieve this for up to eight chairs.

Health and Safety

- Avoid immersing or allowing the X-Rocker to come into contact with liquids.
- Please consult X-Rocker Support before unscrewing any of the electrical components on the chair.
- Please be mindful of any cabling laid out between the X-Rocker and power source/ audio device.
- Please be mindful of cabling attached when moving/ swivelling the X-Rocker.
- If the cables or electrical equipment are broken then this may present a choking risk, please contact Support for replacements and dispose of these parts safely.
- Do not stand on the X-Rocker or exceed the 120kg weight limit via other means.
- Do not lean back on the chair to the point in which the pedestal would lift off the ground.
- X-Rocker armrests are designed for support and comfort during gameplay, please do not use these as support for getting in/ out of the chair.
- Playing audio for long periods at loud volumes may contribute to difficulties in hearing.
- Please be considerate to others when playing audio through the X-Rocker speakers at higher volumes.

Warranty Page

Limited Warranty:

Ace warrants this product against defects in material and workmanship for a period of 1 year from the date of purchase. This warranty is enforceable only by the original purchaser. ALL DAMAGED OR MISSING PARTS MUST BE REPORTED WITHIN 14 DAYS OF PURCHASE. This warranty covers all defects in material and workmanship in this product, but DOES NOT COVER the following:

I. Damage, deterioration or malfunction resulting from:

- a. Acts of God, accident, misuse, abuse, negligence, improper installation, maintenance or operation, or failure to follow the instructions contained in this owner's manual.
 - b. Any damage in the shipment of the product. (Claims must be presented to the carrier.)
 - c. Repair, attempted repair, or modifications by anyone other than the Ace Service Center.
2. Any unit which has been modified or attempted to be modified or altered in any way whatsoever.
 3. Normal wear and periodic maintenance.
 4. Any unit used for industrial or commercial purposes (including rental).
 5. Products sold AS IS or WITH ALL FAULTS, or consumables (such as fuses, batteries, etc).
 6. Customer installation, set up adjustments, or signal reception problems.
 7. Consequential loss or damage as a result of misuse of improper connections.

Ace will repair or replace (at its discretion) units covered by this warranty without charge to the consumer for labor or materials. YOU ARE RESPONSIBLE FOR INITIAL SHIPPING CHARGES. However, we will pay the return shipping charges to any destination within the European Union if repairs are covered by the warranty.

REPAIR OR REPLACEMENT AS PROVIDED UNDER THIS WARRANTY IS THE EXCLUSIVE REMEDY OF THE CONSUMER. ACE SHALL NOT BE LIABLE FOR ANY INCIDENTAL OR CONSEQUENTIAL DAMAGES FOR BREACH OF ANY EXPRESSED OR IMPLIED WARRANTY ON THIS PRODUCT. EXCEPT TO THE EXTENT PROHIBITED BY APPLICABLE LAW, ANY IMPLIED WARRANTIES, INCLUDING WARRANTIES OF MERCHANTABILITY AND FITNESS FOR A PARTICULAR PURPOSE, ARE LIMITED IN DURATION TO THE LENGTH OF THIS WARRANTY.

Operation is subject to the following two conditions:

1. This device may not cause harmful interference.
2. This device must accept any interference received, including interference that may cause undesired operation.

DO NOT SHIP ANYTHING TO US WITHOUT CONTACTING US FIRST. DO NOT SHIP ANY PARTS OR WHOLE UNITS TO THIS ADDRESS FOR REPAIR WITHOUT OUR PERMISSION.



Where you see the Crossed Out Wheelie Bin symbol it means that this product can be recycled and should not be disposed of in normal household rubbish. If you are in the EU, please take it to a collection point for the disposal of Waste Electrical and Electronic Equipment (WEEE) for recycling. For all other countries please adhere to local recycling laws for electrical and electronic equipment. The recycling and processing of Waste Electrical and Electronic Equipment will make a significant contribution towards helping protect the environment by reducing landfill waste.

Manufactured by ACE

671 Crestland Street
Lewisburg, TN 37091
www.acecasual.com
1.866.969.2603
Made in China

Licensed for sale in Europe. For use exclusively with PlayStation®3, PlayStation®Vita and PlayStation®4. "PS" PlayStation, "PS3" and "PS4" are registered trademarks of Sony Interactive Entertainment Inc. Also, "PSVITA" is a trademark of the same company. All rights reserved. *MP3 player compatibility not tested nor endorsed by "Sony Interactive Entertainment Inc". Please retain this packaging for future reference.

UK based customer support: 01274 683 109

V1 07/16

EU & TURKEY ONLY



CE
13