



## MC9x-G (Gun) Series Technical Accessory Guide



NOTE: MC9190-Z (RFID) discontinued 9/2019 - see PMB 10136  
 MC9190-G (non-RFID units) discontinued 9/2015  
 MC9090 Z (RFID) discontinued 1/2013  
 MC9090-G discontinued 4/2012  
 MC9060-G discontinued 4/2007  
 MC9050-G discontinued 3/2004

Does not include MC9x-K (Brick) or MC9x-S (Short) accessories. See separate guide for MC9x-K and MC9x-S accessories  
 Does not include MC95 accessories. See separate guide for MC95 accessories



NOTE: This document is only for general reference. Solution Builder and related PMBs should be used for product availability, pricing, and final solution selection.



\* Zebra does not endorse or specifically recommend any **third-party products, accessories, or hardware**. ZEBRA DISCLAIMS ANY AND ALL LIABILITY, INCLUDING ANY EXPRESS OR IMPLIED WARRANTIES, WHETHER ORAL OR WRITTEN, FOR SUCH THIRD PARTY PRODUCTS, ACCESSORIES, OR HARDWARE. THE CUSTOMER ACKNOWLEDGES THAT NO REPRESENTATION HAS BEEN MADE BY ZEBRA AS TO THE FITNESS OF THE THIRD-PARTY PRODUCTS, ACCESSORIES, OR HARDWARE FOR THE CUSTOMER'S INTENDED PURPOSE.

### Cradles and Charging

#### Cradles





Part Number	Picture	Description	Notes	Required Items
CRD-MC93-2SUCHG-01		MC9300 Single Slot Charge/Communication Cradle	<ul style="list-style-type: none"> <li>Provides USB support</li> <li>Supports MC9300 terminal and spare battery charging.</li> <li>Supports fast-charging of MC9300 device and MC9300 battery:               <ul style="list-style-type: none"> <li>- charges battery from 0-90% in about 3.5 hours.</li> </ul> </li> <li>LED notification of spare battery charging status.</li> <li>Not compatible with MC90/MC91/MC92 devices.</li> </ul>	<ul style="list-style-type: none"> <li>Power Supply (PWR-BGA12V50W0WWW and CBL-DC-388A1-01) - or KIT-PWR-12V50W which includes both.</li> <li>AC Line Cord (23844-00-00R).</li> <li>USB-C cable (CBL-TC5X-USBC2A-01 or CBL-TC2X-USBC-01) or similar 3rd party USB-C standard cable</li> </ul>
CRD9000-1001SR		Single-Slot Serial/USB Cradle	<ul style="list-style-type: none"> <li>Cradle enables serial or USB communication between the MC9x and a host PC.</li> <li>Cradle also charges the terminal with a battery and a spare battery stored in the cradle.</li> <li>LED indicates the charge status of the spare battery</li> <li>Serial port not compatible with Android versions of MC92.</li> <li>No communications support when using MC9300. Will only serve as a Charge-Only cradle when used with MC9300. Does not support fast-charging of MC9300.</li> <li>Does not support charging of MC9300 spare battery.</li> </ul>	<ul style="list-style-type: none"> <li>Power Supply (PWR-BGA12V50W0WWW and CBL-DC-388A1-01) - or KIT-PWR-12V50W which includes both.</li> <li>AC Line Cord (23844-00-00R).</li> <li>25-64396-01R (for USB comm) OR 25-63852-01R (for Serial comm)</li> <li>MC9300 Cradle Adapter (ADP-MC93-CRDCUP-01) when using with MC9300.</li> </ul>





CRD9000-110SES		Single-Slot Serial/USB Cradle Kit	<ul style="list-style-type: none"> <li>▶Cradle enables serial or USB communication between the MC9x and a host PC.</li> <li>▶Cradle also charges the terminal with a battery and a spare battery stored in the cradle.</li> <li>▶LED indicates the charge status of the spare battery</li> <li>▶Includes PWR-BGA12V50W0W, CBL-DC-388A1-01R and 23844-00-00R</li> <li>▶Energy Star Compliant</li> <li>▶Serial port not compatible with Android versions of MC92.</li> <li>▶No communications support when using MC9300. Will only serve as a Charge-Only cradle when used with MC9300. Does not support fast-charging of MC9300.</li> <li>▶Does not support charging of MC9300 spare battery.</li> </ul>	<ul style="list-style-type: none"> <li>▶25-64396-01R (for USB comm) OR 25-63852-01R (for Serial comm)</li> <li>▶MC9300 Cradle Adapter (ADP-MC93-CRDCUP-01) when using with MC9300.</li> </ul>
CRD9000-100SR		Single-Slot Serial/USB Cradle Kit	<ul style="list-style-type: none"> <li>▶Discontinued 12/2007 - replaced by CRD9000-110SR</li> <li>▶Cradle enables serial or USB communication between the MC9x and a host PC.</li> <li>▶Cradle also charges the terminal with a battery and a spare battery stored in the cradle.</li> <li>▶LED indicates the charge status of the spare battery</li> <li>▶Includes 50-14000-148R and 23844-00-00R</li> <li>▶Serial port not compatible with Android versions of MC92.</li> <li>▶No communications support when using MC9300. Will only serve as a Charge-Only cradle when used with MC9300. Does not support fast-charging of MC9300.</li> <li>▶Does not support charging of MC9300 spare battery.</li> </ul>	<ul style="list-style-type: none"> <li>▶25-64396-01R (for USB comm) OR 25-63852-01R (for Serial comm).</li> <li>▶MC9300 Cradle Adapter (ADP-MC93-CRDCUP-01) when using with MC9300.</li> </ul>
CRD9000-110SR		Single-Slot Serial/USB Cradle Kit	<ul style="list-style-type: none"> <li>▶Cradle enables serial or USB communication between the MC9x and a host PC.</li> <li>▶Cradle also charges the terminal with a battery and a spare battery stored in the cradle.</li> <li>▶LED indicates the charge status of the spare battery</li> <li>▶Includes KT-14000-148R and 23844-00-00R</li> <li>▶Serial port not compatible with Android versions of MC92.</li> <li>▶Discontinued 12/2010 - replaced by CRD9000-110SES.</li> <li>▶No communications support when using MC9300. Will only serve as a Charge-Only cradle when used with MC9300. Does not support fast-charging of MC9300.</li> <li>▶Does not support charging of MC9300 spare battery.</li> </ul>	<ul style="list-style-type: none"> <li>▶25-64396-01R (for USB comm) OR 25-63852-01R (for Serial comm)</li> <li>▶MC9300 Cradle Adapter (ADP-MC93-CRDCUP-01) when using with MC9300.</li> </ul>





<p>CRD9000-101SR</p>		<p>Single-Slot Serial/USB Cradle Kit</p>	<ul style="list-style-type: none"> <li>▶Discontinued 12/2007 - replaced by CRD9000-111SR</li> <li>▶Cradle enables serial or USB communication between the MC9x and a host PC.</li> <li>▶Cradle also charges the terminal with a battery and a spare battery stored in the cradle.</li> <li>▶LED indicates the charge status of the spare battery</li> <li>▶Includes 50-14000-148R</li> <li>▶Kit usually order by International customers</li> <li>▶Serial port not compatible with Android versions of MC92.</li> <li>▶No communications support when using MC9300. Will only serve as a Charge-Only cradle when used with MC9300. Does not support fast-charging of MC9300.</li> <li>▶Does not support charging of MC9300 spare battery.</li> </ul>	<ul style="list-style-type: none"> <li>▶23844-00-00R</li> <li>▶25-64396-01R (for USB comm) OR 25-63852-01R (for Serial comm)</li> <li>▶MC9300 Cradle Adapter (ADP-MC93-CRDCUP-01) when using with MC9300.</li> </ul>
<p>KIT-CRD9000-USB1ES</p>		<p>Single-Slot Serial/USB Cradle Kit with USB cable</p>	<ul style="list-style-type: none"> <li>▶Cradle enables serial or USB communication between the MC9x and a host PC.</li> <li>▶Cradle also charges the terminal with a battery and a spare battery stored in the cradle.</li> <li>▶LED indicates the charge status of the spare battery</li> <li>▶Kit includes PWR-BGA12V50W0W, CBL-DC-388A1-01R, 23844-00-00R, and 25-64396-01R.</li> <li>▶Energy Star Compliant</li> <li>▶No communications support when using MC9300. Will only serve as a Charge-Only cradle when used with MC9300. Does not support fast-charging of MC9300.</li> <li>▶Does not support charging of MC9300 spare battery.</li> <li>▶NOTE: This is a custom product. Please work with your Zebra representative to open a Custom Product Request (CPR) if you would like to order this item.</li> </ul>	<ul style="list-style-type: none"> <li>▶MC9300 Cradle Adapter (ADP-MC93-CRDCUP-01) when using with MC9300.</li> </ul>
<p>KIT-CRD9000-USB1R</p>		<p>Single-Slot Serial/USB Cradle Kit with USB cable</p>	<ul style="list-style-type: none"> <li>▶Cradle enables serial or USB communication between the MC9x and a host PC.</li> <li>▶Cradle also charges the terminal with a battery and a spare battery stored in the cradle.</li> <li>▶LED indicates the charge status of the spare battery</li> <li>▶Includes KT-14000-148R, 23844-00-00R, and 25-64396-01R</li> <li>▶Serial port not compatible with Android versions of MC92.</li> <li>▶No communications support when using MC9300. Will only serve as a Charge-Only cradle when used with MC9300. Does not support fast-charging of MC9300.</li> <li>▶Does not support charging of MC9300 spare battery.</li> <li>▶Discontinued 12/2010 - replaced by KIT-CRD9000-USB1ES</li> </ul>	<ul style="list-style-type: none"> <li>▶MC9300 Cradle Adapter (ADP-MC93-CRDCUP-01) when using with MC9300.</li> </ul>

<p>CRD9000-111SES</p>		<p>Single-Slot Serial/USB Cradle Kit</p>	<ul style="list-style-type: none"> <li>▶Cradle enables serial or USB communication between the MC9x and a host PC.</li> <li>▶Cradle also charges the terminal with a battery and a spare battery stored in the cradle.</li> <li>▶LED indicates the charge status of the spare battery</li> <li>▶Includes PWR-BGA12V50W0W and CBL-DC-388A1-01R.</li> <li>▶Kit usually order by International customers</li> <li>▶Energy Star Compliant</li> <li>▶Serial port not compatible with Android versions of MC92.</li> <li>▶No communications support when using MC9300. Will only serve as a Charge-Only cradle when used with MC9300. Does not support fast-charging of MC9300.</li> <li>▶Does not support charging of MC9300 spare battery.</li> </ul>	<ul style="list-style-type: none"> <li>▶23844-00-00R</li> <li>▶25-64396-01R (for USB comm) OR 25-63852-01R (for Serial comm)</li> <li>▶MC9300 Cradle Adapter (ADP-MC93-CRDCUP-01) when using with MC9300.</li> </ul>
<p>CRD9000-111SR</p>		<p>Single-Slot Serial/USB Cradle Kit</p>	<ul style="list-style-type: none"> <li>▶Cradle enables serial or USB communication between the MC9x and a host PC.</li> <li>▶Cradle also charges the terminal with a battery and a spare battery stored in the cradle.</li> <li>▶LED indicates the charge status of the spare battery</li> <li>▶Includes KT-14000-148R</li> <li>▶Kit usually order by International customers</li> <li>▶Serial port not compatible with Android versions of MC92.</li> <li>▶No communications support when using MC9300. Will only serve as a Charge-Only cradle when used with MC9300. Does not support fast-charging of MC9300.</li> <li>▶Does not support charging of MC9300 spare battery.</li> <li>▶Discontinued 12/2010 - replaced by CRD9000-111SES</li> </ul>	<ul style="list-style-type: none"> <li>▶23844-00-00R</li> <li>▶25-64396-01R (for USB comm) OR 25-63852-01R (for Serial comm)</li> <li>▶MC9300 Cradle Adapter (ADP-MC93-CRDCUP-01) when using with MC9300.</li> </ul>
<p>PS6S9000C (3rd party) *</p> <p><a href="http://www.portsmith.com">http://www.portsmith.com</a></p>		<p>Single-Slot Charge-Only Cradle</p>	<ul style="list-style-type: none"> <li>▶Discontinued</li> <li>▶Cradle will only charge an MC9x, no communication.</li> <li>▶No spare battery charging</li> </ul>	<ul style="list-style-type: none"> <li>▶Portsmith Power Supply #190362-000LF or 190362-002LC</li> <li>▶MC9300 Cradle Adapter (ADP-MC93-CRDCUP-01) when using with MC9300.</li> </ul>
<p>PSCMC9100UE (3rd party) *</p> <p><a href="http://www.portsmith.com">http://www.portsmith.com</a></p>		<p>Portsmouth Single-Slot USB/Ethernet Cradle</p>	<ul style="list-style-type: none"> <li>▶USB connection to terminal, 100 Mbps Ethernet connection to LAN</li> <li>▶Will also charge a spare battery</li> <li>▶USB Client connection to MC90xx/MC91xx</li> <li>▶Requires driver from Portsmith website.</li> <li>▶NOT compatible with MC9060 CE devices.</li> <li>▶No communications support when using MC9300. Will only serve as a Charge-Only cradle when used with MC9300. Does not support fast-charging of MC9300.</li> <li>▶Does not support charging of MC9300 spare battery.</li> </ul>	<ul style="list-style-type: none"> <li>▶MC9300 Cradle Adapter (ADP-MC93-CRDCUP-01) when using with MC9300.</li> </ul>





<p>PSCK-MC9100UE (3rd party) *</p> <p><a href="http://www.portsmith.com">http://www.portsmith.com</a></p>		<p>Portsmitth Single-Slot USB/Ethernet Cradle Kit</p>	<ul style="list-style-type: none"> <li>▶USB connection to terminal, 100 Mbps Ethernet connection to LAN</li> <li>▶Will also charge a spare battery</li> <li>▶USB Client connection to MC90xx/MC91xx</li> <li>▶Includes PSCMC9100UE Cradle, Mini USB cable, Ethernet, and Power Cables.</li> <li>▶Requires driver from Portsmitth website.</li> <li>▶NOT compatible with MC9060 CE devices.</li> <li>▶No communications support when using MC9300. Will only serve as a Charge-Only cradle when used with MC9300. Does not support fast-charging of MC9300.</li> <li>▶Does not support charging of MC9300 spare battery.</li> </ul>	<ul style="list-style-type: none"> <li>▶MC9300 Cradle Adapter (ADP-MC93-CRDCUP-01) when using with MC9300.</li> </ul>
<p>PS6SMC9xUE (3rd party) *</p> <p><a href="http://www.portsmith.com">http://www.portsmith.com</a></p>		<p>Single-Slot Ethernet Cradle</p> 	<ul style="list-style-type: none"> <li>▶Discontinued 10/2012, now use PSCMC9100UE/PSCK-MC9100UE</li> <li>▶USB connection to terminal, 10 Mbps Ethernet connection to LAN</li> <li>▶No spare battery charging</li> <li>▶USB Client connection to MC90xx</li> <li>▶Requires Econnect (MC906x), IDockIt (MC909x), or WM Ethernet (MC919x) software on device.</li> <li>▶NOT compatible with MC9190 CE 6.0 devices.</li> <li>▶No communications support when using MC9300. Will only serve as a Charge-Only cradle when used with MC9300. Does not support fast-charging of MC9300.</li> </ul>	<ul style="list-style-type: none"> <li>▶Portsmitth Power Supply #190362-000LF or 190362-002LC</li> <li>▶MC9300 Cradle Adapter (ADP-MC93-CRDCUP-01) when using with MC9300.</li> </ul>
<p>CRD-MC93-4SCHG-01</p>		<p>MC9300 4-Slot Charge-Only ShareCradle</p>	<ul style="list-style-type: none"> <li>▶Will charge up to four MC9300 units.</li> <li>▶Does not charge spare batteries.</li> <li>▶Supports fast-charging of MC93: <ul style="list-style-type: none"> <li>- charges battery from 0-90% in about 3.5 hours.</li> </ul> </li> <li>▶Not compatible with MC90/MC91/MC92 devices.</li> <li>▶Can be racked/ mounted in a standard 19inch rack system via the mounting accessory (BRKT-SCRD-SMRK-01)</li> </ul>	<ul style="list-style-type: none"> <li>▶DC Line Cord (CBL-DC-381A1-01) and Power Supply (PWR-BGA12V108W0WW)</li> <li>▶AC Line Cord (23844-00-00R)</li> </ul>
<p>CRD9101-4001CR</p>		<p>Four Slot Charge Only Cradle</p>	<ul style="list-style-type: none"> <li>▶This cradle charges four MC90/MC91/MC92 terminals simultaneously in approximately two hours.</li> <li>▶Does not charge spare batteries.</li> <li>▶Does not support fast-charging of MC9300.</li> </ul>	<ul style="list-style-type: none"> <li>▶DC Line Cord (CBL-DC-382A1-01) and Power Supply (PWR-BGA12V108W0WW)</li> <li>▶AC Line Cord (23844-00-00R)</li> <li>▶MC9300 Cradle Adapter (ADP-MC93-CRDCUP-01) - QTY 4 - when using with MC9300.</li> </ul>

CHS9000-4001CR		Four Slot Charge Only Cradle	<ul style="list-style-type: none"> <li>▶Discontinued 2/2014, now use CRD9101-4001CR</li> <li>▶This cradle charges four MC90/MC91/MC92 terminals simultaneously in approximately two hours.</li> <li>▶Does not charge spare batteries.</li> <li>▶Does not support fast-charging of MC9300.</li> </ul>	<ul style="list-style-type: none"> <li>▶DC Line Cord (50-16002-029R) and Power Supply (PWRS-14000-241R) OR</li> <li>DC Line Cord (CBL-DC-382A1-01) and Power Supply (PWR-BGA12V108W0WW)</li> <li>▶AC Line Cord (23844-00-00R</li> <li>▶MC9300 Cradle Adapter (ADP-MC93-CRDCUP-01) - QTY 4 - when using with MC9300.</li> </ul>
KIT-CHS9000-US1ES		Four Slot Charge Only Cradle Kit	<ul style="list-style-type: none"> <li>▶This cradle charges four MC90/MC91/MC92 terminals simultaneously in approximately two hours.</li> <li>▶Does not charge spare batteries.</li> <li>▶Does not support fast-charging of MC9300.</li> <li>▶Kit includes Four Slot Charge Only Cradle (CRD9101-4001CR), DC Line Cord (CBL-DC-382A1-01), Power Supply (PWR-BGA12V108W0WW) and AC Line Cord (23844-00-00R).</li> <li>▶NOTE: This is a custom product. Please work with your Zebra representative to open a Custom Product Request (CPR) if you would like to order this item.</li> </ul>	<ul style="list-style-type: none"> <li>▶MC9300 Cradle Adapter (ADP-MC93-CRDCUP-01) - QTY 4 - when using with MC9300.</li> </ul>
CRD9101-411CES		Four Slot Charge Only Cradle Kit	<ul style="list-style-type: none"> <li>▶This cradle charges four MC90/MC91/MC92 terminals simultaneously in approximately two hours.</li> <li>▶Does not charge spare batteries.</li> <li>▶Does not support fast-charging of MC9300.</li> <li>Includes DC Line Cord (CBL-DC-382A1-01), Power Supply (PWR-BGA12V108W0WW)</li> <li>▶Energy Star Compliant</li> </ul>	<ul style="list-style-type: none"> <li>▶AC Line Cord (23844-00-00R)</li> <li>▶MC9300 Cradle Adapter (ADP-MC93-CRDCUP-01) - QTY 4 - when using with MC9300.</li> </ul>
CRD9000-410CES		Four Slot Charge Only Cradle Kit	<ul style="list-style-type: none"> <li>▶Discontinued 2/2014, now use CRD9101-411CES and 23844-00-00R</li> <li>▶This cradle charges four MC90/MC91/MC92 terminals simultaneously in approximately two hours.</li> <li>▶Does not charge spare batteries.</li> <li>▶Does not support fast-charging of MC9300.</li> <li>▶Includes 50-16002-029R, PWRS-14000-241R, and 23844-00-00R</li> <li>▶Energy Star Compliant</li> </ul>	<ul style="list-style-type: none"> <li>▶MC9300 Cradle Adapter (ADP-MC93-CRDCUP-01) - QTY 4 - when using with MC9300.</li> </ul>



CRD9000-400CR		Four Slot Charge Only Cradle Kit	<ul style="list-style-type: none"> <li>▶ Discontinued 12/2007 - replaced by CRD9000-410CR</li> <li>▶ This cradle charges four MC90/MC91/MC92 terminals simultaneously in approximately two hours.</li> <li>▶ Does not charge spare batteries.</li> <li>▶ Does not support fast-charging of MC9300.</li> <li>▶ Includes 50-16002-029R, 50-14001-004R, and 23844-00-00R</li> </ul>	<ul style="list-style-type: none"> <li>▶ MC9300 Cradle Adapter (ADP-MC93-CRDCUP-01) - QTY 4 - when using with MC9300.</li> </ul>
CRD9000-410CR		Four Slot Charge Only Cradle Kit	<ul style="list-style-type: none"> <li>▶ This cradle charges four MC90/MC91/MC92 terminals simultaneously in approximately two hours.</li> <li>▶ Does not charge spare batteries.</li> <li>▶ Does not support fast-charging of MC9300.</li> <li>▶ Includes 50-16002-029R, 50-14000-241R, and 23844-00-00R</li> <li>▶ Discontinued 12/2010 - replaced by CRD9000-410CES</li> </ul>	<ul style="list-style-type: none"> <li>▶ MC9300 Cradle Adapter (ADP-MC93-CRDCUP-01) - QTY 4 - when using with MC9300.</li> </ul>
CRD9000-411CES		Four Slot Charge Only Cradle Kit	<ul style="list-style-type: none"> <li>▶ Discontinued 2/2014, now use CRD9101-411CES</li> <li>▶ This cradle charges four MC90/MC91/MC92 terminals simultaneously in approximately two hours.</li> <li>▶ Does not charge spare batteries.</li> <li>▶ Does not support fast-charging of MC9300.</li> <li>▶ Includes 50-16002-029R and PWRS-14000-241R</li> <li>▶ Kit usually order by International customers</li> <li>▶ Energy Star Compliant</li> </ul>	<ul style="list-style-type: none"> <li>▶ AC Line Cord (23844-00-00R)</li> <li>▶ MC9300 Cradle Adapter (ADP-MC93-CRDCUP-01) - QTY 4 - when using with MC9300.</li> </ul>
CRD9000-401CR		Four Slot Charge Only Cradle Kit	<ul style="list-style-type: none"> <li>▶ Discontinued 12/2007 - replaced by CRD9000-411CR</li> <li>▶ This cradle charges four MC90/MC91/MC92 terminals simultaneously in approximately two hours.</li> <li>▶ Does not charge spare batteries.</li> <li>▶ Does not support fast-charging of MC9300.</li> <li>▶ Includes 50-16002-029R and 50-14001-004R</li> <li>▶ Kit usually order by International customers</li> </ul>	<ul style="list-style-type: none"> <li>▶ AC Line Cord (23844-00-00R)</li> <li>▶ MC9300 Cradle Adapter (ADP-MC93-CRDCUP-01) - QTY 4 - when using with MC9300.</li> </ul>
CRD9000-411CR		Four Slot Charge Only Cradle Kit	<ul style="list-style-type: none"> <li>▶ This cradle charges four MC90/MC91/MC92 terminals simultaneously in approximately two hours.</li> <li>▶ Does not charge spare batteries.</li> <li>▶ Does not support fast-charging of MC9300.</li> <li>▶ Includes 50-16002-029R and 50-14000-241R</li> <li>▶ Kit usually order by International customers</li> <li>▶ Discontinued 12/2010 - replaced by CRD9000-411CES</li> </ul>	<ul style="list-style-type: none"> <li>▶ AC Line Cord (23844-00-00R)</li> <li>▶ MC9300 Cradle Adapter (ADP-MC93-CRDCUP-01) - QTY 4 - when using with MC9300.</li> </ul>





CRD-MC93-4SETH-01		MC9300 4-Slot Ethernet/Charging ShareCradle	<ul style="list-style-type: none"> <li>▶Allows network speeds up to 1 Gb</li> <li>▶Will charge up to four MC9300 units.</li> <li>▶Supports fast-charging of MC93: <ul style="list-style-type: none"> <li>- charges battery from 0-90% in about 3.5 hours.</li> </ul> </li> <li>▶Provides Ethernet daisy chaining support for connecting multiple cradles together.</li> <li>▶Not compatible with MC90/MC91/MC92 devices.</li> <li>▶Can be racked/mounted in a standard 19 inch rack system via the mounting accessory (BRKT-SCRD-SMRK-01)</li> </ul>	<ul style="list-style-type: none"> <li>▶DC Line Cord (CBL-DC-381A1-01) and Power Supply (PWR-BGA12V108W0WWW)</li> <li>▶AC Line Cord (23844-00-00R)</li> </ul>
CRD9101-4001ER		Four Slot Ethernet/Charging Cradle	<ul style="list-style-type: none"> <li>▶Allows speeds up to 1 Gb</li> <li>▶Uses less power than CRD9000-4001ER</li> <li>▶Does not charge spare batteries.</li> <li>▶No communications support when using MC9300. Will only serve as a Charge-Only cradle when used with MC9300. Does not support fast-charging of MC9300.</li> <li>▶USB connection to terminal, Ethernet connection to LAN</li> <li>▶USB Client connection to MC90xx - requires Econnect (MC906x) or IDockIt (MC909x) software on device.</li> </ul>	<ul style="list-style-type: none"> <li>▶DC Line Cord (CBL-DC-382A1-01) and Power Supply (PWR-BGA12V108W0WWW)</li> <li>▶AC Line Cord (23844-00-00R)</li> <li>▶MC9300 Cradle Adapter (ADP-MC93-CRDCUP-01) - QTY 4 - when using with MC9300.</li> </ul>
CRD9101-4000ER		Four Slot Ethernet/Charging Cradle	<ul style="list-style-type: none"> <li>▶Not released</li> <li>▶Allows speeds up to 1 Gb</li> <li>▶Uses less power than CRD9000-4001ER</li> <li>▶Does not charge spare batteries.</li> <li>▶No communications support when using MC9300. Will only serve as a Charge-Only cradle when used with MC9300. Does not support fast-charging of MC9300.</li> <li>▶USB connection to terminal, Ethernet connection to LAN</li> <li>▶USB Client connection to MC90xx - requires Econnect (MC906x) or IDockIt (MC909x) software on device.</li> </ul>	<ul style="list-style-type: none"> <li>▶DC Line Cord (50-16002-029R) and Power Supply (PWRS-14000-241R) OR</li> <li>DC Line Cord (CBL-DC-382A1-01) and Power Supply (PWR-BGA12V108W0WWW)</li> <li>▶AC Line Cord (23844-00-00R)</li> <li>▶MC9300 Cradle Adapter (ADP-MC93-CRDCUP-01) - QTY 4 - when using with MC9300.</li> </ul>
CRD9000-4001ER		Four Slot Ethernet/Charging Cradle	<ul style="list-style-type: none"> <li>▶Discontinued 1/2016, now use CRD9101-4001ER - PMB 2757</li> <li>▶Does not charge spare batteries .</li> <li>▶No communications support when using MC9300. Will only serve as a Charge-Only cradle when used with MC9300. Does not support fast-charging of MC9300.</li> <li>▶USB connection to terminal, Ethernet connection to LAN</li> <li>▶USB Client connection to MC90xx - requires Econnect (MC906x) or IDockIt (MC909x) software on device.</li> </ul>	<ul style="list-style-type: none"> <li>▶DC Line Cord (50-16002-029R) and Power Supply (PWRS-14000-241R) OR</li> <li>DC Line Cord (CBL-DC-382A1-01) and Power Supply (PWR-BGA12V108W0WWW)</li> <li>▶AC Line Cord (23844-00-00R)</li> <li>▶MC9300 Cradle Adapter (ADP-MC93-CRDCUP-01) - QTY 4 - when using with MC9300.</li> </ul>

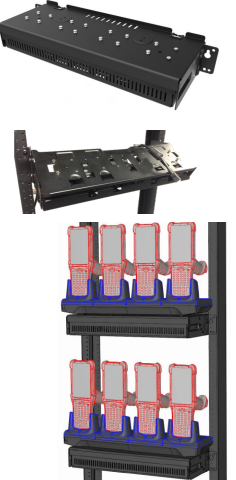









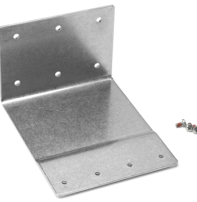

CRD9101-410EES		Four Slot Ethernet/Charging Cradle Kit	<ul style="list-style-type: none"> <li>▶Allows speeds up to 1 Gb</li> <li>▶Uses less power than CRD9000-4001ER</li> <li>▶Does not charge spare batteries.</li> <li>▶No communications support when using MC9300. Will only serve as a Charge-Only cradle when used with MC9300. Does not support fast-charging of MC9300.</li> <li>▶USB connection to terminal, Ethernet connection to LAN</li> <li>▶USB Client connection to MC90xx - requires Econnect (MC906x) or IDockIt (MC909x) software on device.</li> <li>▶Includes CRD9101-4001ER, DC Line Cord (CBL-DC-382A1-01), Power Supply (PWR-BGA12V108W0WW), and AC Line Cord (23844-00-00R)</li> <li>▶Energy Star Compliant</li> </ul>	<ul style="list-style-type: none"> <li>▶MC9300 Cradle Adapter (ADP-MC93-CRDCUP-01) - QTY 4 - when using with MC9300.</li> </ul>
CRD9000-410EES		Four Slot Ethernet/Charging Cradle Kit	<ul style="list-style-type: none"> <li>▶Discontinued 1/2016, now use CRD9101-410EES - PMB 2757</li> <li>▶Does not charge spare batteries.</li> <li>▶No communications support when using MC9300. Will only serve as a Charge-Only cradle when used with MC9300. Does not support fast-charging of MC9300.</li> <li>▶USB connection to terminal, Ethernet connection to LAN</li> <li>▶USB Client connection to MC90xx - requires Econnect (MC906x) or IDockIt (MC909x) software on device.</li> <li>▶Includes 50-16002-029R, PWRS-14000-241R, and 23844-00-00R</li> <li>▶Energy Star Compliant</li> </ul>	<ul style="list-style-type: none"> <li>▶MC9300 Cradle Adapter (ADP-MC93-CRDCUP-01) - QTY 4 - when using with MC9300.</li> </ul>
CRD9000-400ER		Four Slot Ethernet/Charging Cradle Kit	<ul style="list-style-type: none"> <li>▶Discontinued 12/2007 - replaced by CRD9000-410ER</li> <li>▶Does not charge spare batteries</li> <li>▶No communications support when using MC9300. Will only serve as a Charge-Only cradle when used with MC9300. Does not support fast-charging of MC9300.</li> <li>▶USB connection to terminal, Ethernet connection to LAN</li> <li>▶USB Client connection to MC90xx - requires Econnect (MC906x) or IDockIt (MC909x) software on device.</li> <li>▶Includes 50-16002-029R, 50-14001-004R, and 23844-00-00R</li> </ul>	<ul style="list-style-type: none"> <li>▶MC9300 Cradle Adapter (ADP-MC93-CRDCUP-01) - QTY 4 - when using with MC9300.</li> </ul>
CRD9000-410ER		Four Slot Ethernet/Charging Cradle Kit	<ul style="list-style-type: none"> <li>▶Does not charge spare batteries.</li> <li>▶No communications support when using MC9300. Will only serve as a Charge-Only cradle when used with MC9300. Does not support fast-charging of MC9300.</li> <li>▶USB connection to terminal, Ethernet connection to LAN</li> <li>▶USB Client connection to MC90xx - requires Econnect (MC906x) or IDockIt (MC909x) software on device.</li> <li>▶Includes 50-16002-029R, 50-14000-241R, and 23844-00-00R</li> <li>▶Discontinued 12/2010 - replaced by CRD9000-410EES</li> </ul>	<ul style="list-style-type: none"> <li>▶MC9300 Cradle Adapter (ADP-MC93-CRDCUP-01) - QTY 4 - when using with MC9300.</li> </ul>

CRD9101-411EES		Four Slot Ethernet/Charging Cradle Kit	<ul style="list-style-type: none"> <li>▶Allows speeds up to 1 Gb</li> <li>▶Uses less power than CRD9000-4001ER</li> <li>▶Does not charge spare batteries.</li> <li>▶No communications support when using MC9300. Will only serve as a Charge-Only cradle when used with MC9300. Does not support fast-charging of MC9300.</li> <li>▶USB connection to terminal, Ethernet connection to LAN</li> <li>▶USB Client connection to MC90xx - requires Econnect (MC906x) or IDockIt (MC909x) software on device.</li> <li>▶Includes CRD9101-4001ER, DC Line Cord (CBL-DC-382A1-01), Power Supply (PWR-BGA12V108W0WW)</li> <li>▶Kit usually order by International customers</li> <li>▶Energy Star Compliant</li> </ul>	<ul style="list-style-type: none"> <li>▶AC Line Cord (23844-00-00R)</li> <li>▶MC9300 Cradle Adapter (ADP-MC93-CRDCUP-01) - QTY 4 - when using with MC9300.</li> </ul>
CRD9000-411EES		Four Slot Ethernet/Charging Cradle Kit	<ul style="list-style-type: none"> <li>▶Discontinued 1/2016, now use CRD9101-411EES - PMB 2757</li> <li>▶Does not charge spare batteries .</li> <li>▶No communications support when using MC9300. Will only serve as a Charge-Only cradle when used with MC9300. Does not support fast-charging of MC9300.</li> <li>▶USB connection to terminal, Ethernet connection to LAN</li> <li>▶USB Client connection to MC90xx - requires Econnect (MC906x) or IDockIt (MC909x) software on device.</li> <li>▶Includes 50-16002-029R and PWRS-14000-241R</li> <li>▶Kit usually order by International customers</li> <li>▶Energy Star Compliant</li> </ul>	<ul style="list-style-type: none"> <li>▶AC Line Cord (23844-00-00R)</li> <li>▶MC9300 Cradle Adapter (ADP-MC93-CRDCUP-01) - QTY 4 - when using with MC9300.</li> </ul>
CRD9000-401ER		Four Slot Ethernet/Charging Cradle Kit	<ul style="list-style-type: none"> <li>▶Discontinued 12/2007 - replaced by CRD9000-411ER</li> <li>▶Does not charge spare batteries.</li> <li>▶No communications support when using MC9300. Will only serve as a Charge-Only cradle when used with MC9300. Does not support fast-charging of MC9300.</li> <li>▶USB connection to terminal, Ethernet connection to LAN</li> <li>▶USB Client connection to MC90xx - requires Econnect (MC906x) or IDockIt (MC909x) software on device.</li> <li>▶Includes 50-16002-029R and 50-14001-004R</li> <li>▶Kit usually order by International customers</li> </ul>	<ul style="list-style-type: none"> <li>▶AC Line Cord (23844-00-00R)</li> <li>▶MC9300 Cradle Adapter (ADP-MC93-CRDCUP-01) - QTY 4 - when using with MC9300.</li> </ul>
CRD9000-411ER		Four Slot Ethernet/Charging Cradle Kit	<ul style="list-style-type: none"> <li>▶Does not charge spare batteries.</li> <li>▶No communications support when using MC9300. Will only serve as a Charge-Only cradle when used with MC9300. Does not support fast-charging of MC9300.</li> <li>▶USB connection to terminal, Ethernet connection to LAN</li> <li>▶USB Client connection to MC90xx - requires Econnect (MC906x) or IDockIt (MC909x) software on device.</li> <li>▶Includes 50-16002-029R and 50-14000-241R</li> <li>▶Kit usually order by International customers</li> <li>▶Discontinued 12/2010 - replaced by CRD9000-411EES</li> </ul>	<ul style="list-style-type: none"> <li>▶AC Line Cord (23844-00-00R)</li> <li>▶MC9300 Cradle Adapter (ADP-MC93-CRDCUP-01) - QTY 4 - when using with MC9300.</li> </ul>

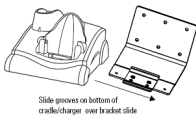

ADP-MC93-CRDCUP-01		MC9300 Adapter Cup to MC90/MC91/MC92 Legacy Cradles	<ul style="list-style-type: none"> <li>Allows MC9300 to be used with MC90/MC91/MC92 Single Slot and Multi-Slot Cradles.</li> <li>Adapter Cup includes circuitry to convert between voltages differences of MC90/MC91/MC92 and MC9300.</li> <li>NOTE: Adapter Cup does not provide communications support (USB, Serial, Ethernet). Will only provide charging support.</li> <li>Does NOT support fast-charging of MC9300. MC9300 used in legacy cradles will be charged at standard rate: <ul style="list-style-type: none"> <li>charges battery from 0-90% in about 5.8 hours at standard charging rate.</li> </ul> </li> <li>Order one Adapter Cup for Single Slot Cradles and four Adapter Cups for Multi-Slot Cradles.</li> </ul>	
BRKT-SCRD-SMRK-01		MC9300 4-Slot ShareCradle Mounting Bracket	<ul style="list-style-type: none"> <li>Allows for rack and wall mounting of one MC9300 4-Slot ShareCradle, up to four MC9300 Single Slot ShareCradles, or up to four MC9300 4-Slot Battery Chargers.</li> <li>Bracket can be mounted on standard 19" network rack or on a wall.</li> <li>Has cable routing slots and removable power supply tray that stores and conceals power supplies.</li> <li>Adjustable tabs &amp; screw mounts for easy hanging/installation.</li> <li>Adjustable orientations: <ul style="list-style-type: none"> <li>25° High Density (5-Slot Charge Only Cradle)</li> <li>Horizontal (Single Slot Cradle or 4-Slot Battery Chargers).</li> </ul> </li> <li>See the Bluetooth-Generic Accessories TAG for info on 3rd party Network Racks that can be used for mounting this bracket.</li> </ul>	
<b>Battery Charging</b>				
Part Number	Picture	Description	Notes	Required Items
SAC-MC93-4SCHG-01		MC9300 4-Slot Battery Charger	<ul style="list-style-type: none"> <li>This cradle charges MC9300 spare batteries only.</li> <li>Supports fast-charging of MC9300 batteries: <ul style="list-style-type: none"> <li>charges battery from 0-90% in about 3.3 hours vs. 5.8 hours for standard charging rate.</li> </ul> </li> <li>Can be used standalone or up to four chargers can be installed on Multi-Slot Wall/Rack Mount Bracket (BRKT-SCRD-SMRK-01).</li> <li>Not compatible with MC90/MC91/MC92 series spare batteries.</li> </ul>	<p><u>To power single 4-slot Charger:</u></p> <ul style="list-style-type: none"> <li>Power Supply (PWR-BGA12V50W0WW)</li> <li>DC Line Cord (CBL-DC-388A1-01)</li> <li>AC Line Cord (23844-00-00R)</li> </ul> <p><u>To power two sets of 4-slot Chargers from one power supply:</u></p> <ul style="list-style-type: none"> <li>Power Supply (PWR-BGA12V108W0WW)</li> <li>DC Y-Cable Line Cord (CBL-DC-523A1-01)</li> <li>AC Line Cord (23844-00-00R)</li> </ul> <p><u>To power four 4-slot Chargers:</u> Use MC9300 16-Slot Battery Charger (SAC-MC93-16SCHG-01) instead.</p>

SAC-MC93-16SCHG-01		MC9300 16-Slot Battery Charger	<ul style="list-style-type: none"> <li>▶Charges MC9300 spare batteries.</li> <li>▶Uses 5-Slot ShareCradle with four 4-Slot Battery Chargers (SAC-MC93-4SCHG-01) attached.</li> <li>▶Supports fast-charging of MC9300 batteries: <ul style="list-style-type: none"> <li>- charges battery from 0-90% in about 3.3 hours vs. 5.8 hours for standard charging rate.</li> </ul> </li> <li>▶Can be racked/mounted in a standard 19 inch rack system via the mounting accessory (BRKT-SCRD-SMRK-01).</li> <li>▶Not compatible with MC90/MC91/MC92 series spare batteries.</li> </ul>	<ul style="list-style-type: none"> <li>▶Power Supply (PWR-BGA12V108W0WWW)</li> <li>▶DC Line Cord (CBL-DC-381A1-01)</li> <li>▶AC Line Cord (23844-00-00R)</li> </ul>
SAC9000-4000R		MC90/MC91/MC92 Four Slot Spare Battery Charger	<ul style="list-style-type: none"> <li>▶This cradle charges four MC90/MC91/MC92 batteries simultaneously in approximately two hours.</li> <li>▶Does not support charging of MC9300 batteries.</li> </ul>	<ul style="list-style-type: none"> <li>▶Power Supply (PWRS-14000-242R) and DC Line Cord (25-72614-01R)</li> <li>OR</li> <li>▶Power Supply (PWR-BGA12V50W0WWW and DC Line Cord (CBL-DC-395A1-01) - or KT-PWR-50W395A1-01 which includes both.</li> <li>▶AC Line Cord (23844-00-00R)</li> </ul>
SAC9000-400CES		MC90/MC91/MC92 Four Slot Spare Battery Charger Kit	<ul style="list-style-type: none"> <li>▶This cradle charges four MC90/MC91/MC92 batteries simultaneously in approximately two hours.</li> <li>▶Does not support charging of MC9300 batteries.</li> <li>▶Includes Power Supply (PWR-BGA12V50W0WWW), DC Line Cord (CBL-DC-395A1-01), and AC Line Cord (23844-00-00R), as of 12/2017 (PMB 3068) - prior to that included 25-72614-01R, PWRS-14000-242R, and 23844-00-00R</li> <li>▶Energy Star Compliant</li> </ul>	
SAC9000-400R		MC90/MC91/MC92 Four Slot Spare Battery Charger Kit	<ul style="list-style-type: none"> <li>▶This cradle charges four MC90/MC91/MC92 batteries simultaneously in approximately two hours.</li> <li>▶Does not support charging of MC9300 batteries.</li> <li>▶Includes 25-72614-01R, 50-14000-242R, and 23844-00-00R</li> <li>▶Discontinued 12/2010 - replaced by SAC9000-400CES</li> </ul>	
KIT-SAC9000-4001ES		MC90/MC91/MC92 Four Slot Spare Battery Charger Kit	<ul style="list-style-type: none"> <li>▶This cradle charges four MC90/MC91/MC92 batteries simultaneously in approximately two hours.</li> <li>▶Does not support charging of MC9300 batteries.</li> <li>▶Includes Power Supply (PWR-BGA12V50W0WWW) and DC Line Cord (CBL-DC-395A1-01), as of 12/2017 (PMB 3068) - prior to that included 25-72614-01R and PWRS-14000-242R</li> <li>▶Kit is normally ordered by International customers</li> <li>▶Energy Star Compliant</li> </ul>	AC Line Cord (23844-00-00R)









21-32665-48R		UBC Adapter for MC90/MC91/MC92 Gun or Brick	<ul style="list-style-type: none"> <li>► This device makes the charging of multiple batteries easy and cost effective. Simply snap the battery into the adapter and slide the adapter into the UBC charging station. The charging station holds up to four adapters.</li> <li>► Does not support charging of MC9300 batteries.</li> </ul>	KT32665-02R OR KT32665-03R OR UBC2000-I500DES
UBC2000-I500DES		UBC Charging Station	<ul style="list-style-type: none"> <li>► Quad bay charger. Holds four UBC adapter modules.</li> <li>Includes 50-16002-011R power cord and PWRS-14000-242R power supply</li> <li>► Energy Star certified</li> </ul>	<ul style="list-style-type: none"> <li>► 23844-00-00R AC Line Cord</li> <li>► 1 to 4 UBC adapters</li> </ul>
UBC2000-I500DR		UBC Charging Station	<ul style="list-style-type: none"> <li>► Discontinued 12/2012, now use UBC2000-I500DES</li> <li>► Quad bay charger. Holds four UBC adapter modules.</li> <li>Includes 50-16002-011R power cord and 50-14001-008R/50-14000-242R/PWRS-14000-242R power supply</li> </ul>	<ul style="list-style-type: none"> <li>► 23844-00-00R AC Line Cord</li> <li>► 1 to 4 UBC adapters</li> </ul>
KT-32665-01R		Wall Mount Bracket for UBC2000 Battery Charger	<ul style="list-style-type: none"> <li>► Discontinued 9/2011</li> </ul>	
KT-61498-01R		Cradle Wall Mounting Bracket	<ul style="list-style-type: none"> <li>► This bracket provides a convenient mounting option for mounting MC90/MC91/MC92 Single Slot Cradles, 4-slot Cradles, or SAC9000 units to a wall.</li> <li>► Order one to mount single slot cradle or SAC9000</li> <li>► Order two to mount 4-Slot cradle</li> </ul>	KT-61499-01R
KT-61499-01R		Shelf Slide Cradle Bracket	<ul style="list-style-type: none"> <li>► Bracket mounts to the Cradle Wall Mounting Bracket and allows the cradle to be slid onto the bracket (see picture).</li> <li>► Order one for MC90/MC91/MC92 Single Slot Cradle or SAC9000.</li> <li>► Order two for MC90/MC91/MC92 4-Slot Cradle or to mount two MC90/MC91/MC92 single slot cradles side-by-side.</li> </ul>  <p>Slide grooves on bottom of cradle/charger over bracket slide</p>	KT-61498-01R
<b>Direct to Device Charging</b>				
<b>Part Number</b>	<b>Picture</b>	<b>Description</b>	<b>Notes</b>	<b>Required Items</b>

CBL-MC93-USBCHG-01		MC9300 USB Communication/Charging Cable Adapter	<ul style="list-style-type: none"> <li>Attaches to charge/communication port on bottom of MC9300.</li> <li>Provides both USB communications and charging support.</li> <li>Will charge battery in MC9300 from 0-90% in as little as 3.5 hours when used with USB Power Supply (PWR-WUA5V12W0xx)</li> <li>Only compatible with MC9300.</li> </ul>	<ul style="list-style-type: none"> <li>USB-C cable (CBL-TC5X-USBC2A-01 or CBL-TC2X-USBC-01) or similar 3rd party USB-C standard cable</li> <li>USB charger...</li> </ul> <p><b>Indoor use:</b> order Country Specific version of USB Power Supply (PWR-WUA5V12W0xx)</p> <p><b>In Vehicle use:</b> USB Cigarette Lighter Adapter (CHG-AUTO-USB1-01)</p>
KT-ADP9000-100ES		MC90/MC91/MC92 Charging Kit	<ul style="list-style-type: none"> <li>Includes ADP9000-100R, PWR-BGA12V50W0W, CBL-DC-388A1-01R, and 23844-00-00R</li> <li>Energy Star Compliant</li> <li>Not compatible with MC9300 devices.</li> </ul>	can use a communication cable for ADP9000 listed below
KT-ADP9000-100R		MC90/MC91/MC92 Charging Kit	<ul style="list-style-type: none"> <li>Includes ADP9000-100R, KT-14000-148R, and 23844-00-00R</li> <li>Discontinued 12/2010 - replaced by KT-ADP9000-100ES</li> <li>Not compatible with MC9300 devices.</li> </ul>	can use a communication cable for ADP9000 listed below
ADP9000-100R		MC90/MC91/MC92 Cable Adapter Module	<ul style="list-style-type: none"> <li>Serial port not compatible with Android versions of MC92.</li> <li>Not compatible with MC9300 devices.</li> <li>This convenient and lightweight snap-on cable adapter provides the mechanism and the flexibility for cable communication, as well as auto charging capability.</li> </ul>	<p><u>For charging via AC wall outlet:</u></p> <ul style="list-style-type: none"> <li>Power Supply (PWR-BGA12V50W0WW and CBL-DC-388A1-01) - or KIT-PWR-12V50W which includes both.</li> <li>AC Line Cord (23844-00-00R)</li> </ul> <p><u>For charging in vehicle:</u> Cigarette Lighter Adapter (VCA9002-12R or VCA9000-24R)</p>







**Communication Cables**

Part Number	Picture	Description	Notes	Required Items
CBL-TC5X-USBC2A-01		USB-C cable for MC9300 Charging/Communication	<ul style="list-style-type: none"> <li>USB-A to USB-C cable</li> <li>Attaches to MC9300 Single Slot Charge/Communication Cradle (CRD-MC93-2SUCHG-01) OR to USB-C port on the MC9300 USB Communication-Charging Cable Adapter (CBL-MC93-USBCHG-01).</li> <li>Cable length is 1M (~3.25 ft.)</li> </ul>	<p>For use with MC9300 USB Communication/Charging Cable Adapter (CBL-MC93-USBCHG-01):</p> <ul style="list-style-type: none"> <li>For charging via AC Wall Outlet: USB Power Adapter (PWR-WUA5V12W0US - or country specific version)</li> <li>For charging in-vehicle: USB Cigarette Lighter Adapter (CHG-AUTO-USB1-01)</li> </ul>
CBL-TC2X-USBC-01		USB-C cable for MC9300 Charging/Communication	<ul style="list-style-type: none"> <li>USB-A to USB-C cable</li> <li>Attaches to MC9300 Single Slot Charge/Communication Cradle (CRD-MC93-2SUCHG-01) OR to USB-C port on the MC9300 USB Communication-Charging Cable Adapter (CBL-MC93-USBCHG-01).</li> <li>Cable length is 1.5M (~5 ft.)</li> </ul>	<p>For use with MC9300 USB Communication/Charging Cable Adapter (CBL-MC93-USBCHG-01):</p> <ul style="list-style-type: none"> <li>For charging via AC Wall Outlet: USB Power Adapter (PWR-WUA5V12W0US - or country specific version)</li> <li>For charging in-vehicle: USB Cigarette Lighter Adapter (CHG-AUTO-USB1-01)</li> </ul>









3rd party *		USB-C cable for MC9300 Charging/Communication	<ul style="list-style-type: none"> <li>Attaches to MC9300 Single Slot Charge/Communication Cradle (CRD-MC93-2SUCHG-01) OR to USB-C port on the MC9300 USB Communication-Charging Cable Adapter (CBL-MC93-USBCHG-01).</li> </ul>	<p>For use with MC9300 USB Communication/Charging Cable Adapter (CBL-MC93-USBCHG-01):</p> <ul style="list-style-type: none"> <li>For charging via AC Wall Outlet: USB Power Adapter (PWR-WUA5V12W0US - or country specific version)</li> <li>For charging in-vehicle: USB Cigarette Lighter Adapter (CHG-AUTO-USB1-01)</li> </ul>
25-64396-01R		USB Cable for MC90/MC91/MC92 Single Slot Cradle	<ul style="list-style-type: none"> <li>Not compatible with MC9300 cradles</li> </ul>	CRD9000-1001SR
25-63852-01R		Serial ActiveSync Cable for MC90/MC91/MC92 Single Slot Cradle	<ul style="list-style-type: none"> <li>Serial port not compatible with Android versions of MC92.</li> <li>Not compatible with MC9300 cradles.</li> </ul>	CRD9000-1001SR
25-63856-01R		Modem Cable for MC90/MC91/MC92 Single-Slot Cradle	<ul style="list-style-type: none"> <li>Needed to connect the MDM9000-100 (Modem Module) to the CRD9000-1001S (Single Slot Cradle).</li> <li>Allows single slot cradle to be used as a modem cradle.</li> <li>Serial port not compatible with Android versions of MC92.</li> <li>Not compatible with MC9300 cradles.</li> </ul>	CRD9000-1001SR and MDM9000-100R
25-62164-01R		MC90/MC91/MC92 RS232 Cable (9 pin)	<ul style="list-style-type: none"> <li>Serial port not compatible with Android versions of MC92.</li> <li>Discontinued 9/2011</li> </ul>	ADP9000-100R
25-62166-01R		MC90/MC91/MC92 USB Cable		ADP9000-100R
25-62167-02R		MC90/MC91/MC92 DEX Cable	<ul style="list-style-type: none"> <li>Serial port not compatible with Android versions of MC92.</li> </ul>	ADP9000-100R
25-62167-03R		MC90/MC91/MC92 DEX Cable with Floating Jack Screws	<ul style="list-style-type: none"> <li>Serial port not compatible with Android versions of MC92.</li> </ul>	ADP9000-100R
25-62168-01R		MC90/MC91/MC92 Printer Cable (Paxar)	<ul style="list-style-type: none"> <li>Serial port not compatible with Android versions of MC92.</li> </ul>	ADP9000-100R



25-62169-01R		MC90/MC91/MC92 Printer Cable (O'Neil)	<ul style="list-style-type: none"> <li>Serial port not compatible with Android versions of MC92.</li> </ul>	ADP9000-100R
P1031365-054		MC90/MC91/MC92 QLn Series Printer Cable (Zebra)	<ul style="list-style-type: none"> <li>30" coiled cable</li> <li>Serial port not compatible with Android versions of MC92.</li> </ul>	ADP9000-100R
25-62170-02R		MC90/MC91/MC92 QL Series Printer Cable (Zebra)	<ul style="list-style-type: none"> <li>Serial port not compatible with Android versions of MC92.</li> </ul>	ADP9000-100R
25-71915-01R		USB Host Cable for MC90/MC91/MC92 Fork Lift Cradle	<ul style="list-style-type: none"> <li>USB Rugged connector to USB A Male (cable has female connector on it). Used to connect MC90xx FLC to peripherals like printers and keyboards.</li> <li>6 in long</li> </ul>	
25-71916-01R		MC90/MC91/MC92 Fork Lift Cradle to LS3203ER Cable (serial)	<ul style="list-style-type: none"> <li>Coiled, 9 ft. long when extended</li> <li>Serial port not compatible with Android versions of MC92.</li> </ul>	
25-71917-03R		MC90/MC91/MC92 Fork Lift Cradle to LS34xx Cable (serial)	<ul style="list-style-type: none"> <li>9 ft long when extended</li> <li>Improved performance in freezer environments vs. 25-71917-02R. The conductor insulation material was changed to a stiffer material so the copper does not flex at as sharp an angle, resulting in a longer bend life.</li> </ul>	
25-71917-02R		MC90/MC91/MC92 Fork Lift Cradle to LS34xx Cable (serial)	<ul style="list-style-type: none"> <li>Discontinued 4/2016, now use 25-71917-03R - PMB 2712</li> <li>Serial port not compatible with Android versions of MC92.</li> <li>9 ft long when extended</li> </ul>	
CBA-RF4-C09ZBR		MC90/MC91/MC92 Fork Lift Cradle to 36xx Cable (serial)	<ul style="list-style-type: none"> <li>9 ft long when extended</li> <li>Rated to -30°C for freezer environment use.</li> <li>Not capable of powering DS3608-ER in default power mode - scanner will need to use ER Low Power option to work properly.</li> <li>When connected to STB3678/FLB3678, will charge a fully depleted battery in about 10.5 hours.</li> <li>Includes increased TTL current limit protection vs. CBA-RF-C09ZAR.</li> </ul>	
CBA-RF4-C09ZAR		MC90/MC91/MC92 Fork Lift Cradle to 36xx Cable (serial)	<ul style="list-style-type: none"> <li>9 ft long when extended</li> <li>Rated to -30°C for freezer environment use.</li> <li>Not capable of powering DS3608-ER in default power mode - scanner will need to use ER Low Power option to work properly.</li> <li>When connected to STB3678/FLB3678, will charge a fully depleted battery in about 10.5 hours.</li> </ul>	





CBL-71918-12R		MC90/MC91/MC92 Fork Lift Cradle to LS34xx Cable (USB)	<ul style="list-style-type: none"> <li>►To be discontinued 1/2020 - see PMB 10261</li> <li>►9 ft long when extended</li> <li>►Improved performance in freezer environments vs. CBL-71918-11R. The conductor insulation material was changed to a stiffer material so the copper does not flex at as sharp an angle, resulting in a longer bend life.</li> </ul>	
CBL-71918-11R		MC90/MC91/MC92 Fork Lift Cradle to LS34xx Cable (USB)	<ul style="list-style-type: none"> <li>►Discontinued 4/2016, now use CBL-71918-12R - PMB 2712</li> <li>►NOTE: Recommend using 25-71918-01R in freezer environments instead of this cable.</li> <li>►Cable adds additional components vs. 25-71918-01R to keep inner wiring from being over torqued under certain installation conditions.</li> <li>►9 ft long when extended</li> </ul>	
25-71918-01R		MC90/MC91/MC92 Fork Lift Cradle to LS34xx Cable (USB)	<ul style="list-style-type: none"> <li>►9 ft long when extended</li> </ul>	
CBA-U40-C09ZAR		MC90/MC91/MC92 Fork Lift Cradle to DS3508-ER "Y" Cable (USB)	<ul style="list-style-type: none"> <li>►To be discontinued 1/2020 - see PMB 10261</li> <li>►Y cable design connects to COM1 AND USB port (requires 25-71915-01R USB host adapter)</li> <li>►USB communication between FLC9000 and scanner. NOTE: MC92 may need to be set to USB Host Mode.</li> <li>►COM1 port provides additional power needed for DS3508-ER. NOTE: An application (i.e. SerialWedge or DataWedge) must be used to open the COM port before power will be applied to it.</li> <li>►Coiled cable is 9 ft long when extended</li> <li>►Rated to -30°C for freezer environment use.</li> <li>►Not compatible with Android versions of MC92.</li> </ul>	USB Host Adapter (25-71915-01R)
CBA-UF3-C09ZAR		MC90/MC91/MC92 Fork Lift Cradle to 36xx Cable (USB)	<ul style="list-style-type: none"> <li>►9 ft long when extended</li> <li>►Rated to -30°C for freezer environment use.</li> <li>►Not capable of powering DS3608-ER in default power mode - scanner will need to use ER Low Power option to work properly.</li> <li>►When connected to STB3678/FLB3678, will charge a fully depleted battery in about 10.5 hours.</li> </ul>	
CBA-UF5-C09ZAR		MC90/MC91/MC92 Fork Lift Cradle to DS3608-ER "Y" Cable (USB)	<ul style="list-style-type: none"> <li>►Y cable design connects to COM1 AND USB port (requires 25-71915-01R USB host adapter)</li> <li>►USB communication between FLC9000 and scanner. NOTE: MC92 may need to be set to USB Host Mode.</li> <li>►COM1 port provides additional power needed for DS3608-ER in default power mode. NOTE: An application (i.e. SerialWedge or DataWedge) must be used to open the COM port before power will be applied to it.</li> <li>►Coiled cable is 9 ft long when extended</li> <li>►Rated to -30°C for freezer environment use.</li> <li>►Not compatible with Android versions of MC92.</li> </ul>	USB Host Adapter (25-71915-01R)





25-71924-01R		MC90/MC91/MC92 Fork Lift Cradle Rugged DB9 serial cable	<ul style="list-style-type: none"> <li>Serial port not compatible with Android versions of MC92.</li> <li>RS232 Rugged connector to DB9 Male (cable has female connector on it)</li> </ul>	
RS409-SR2000Z1R		RS409 Scanner	<ul style="list-style-type: none"> <li>Discontinued 11/2011</li> <li>Allows the RS409 (WT4090 scanner) to be used with the MC90xx.</li> <li>Has cable connector to attach to the MC90xx's ADP9000-110R</li> <li>Serial port not compatible with Android versions of MC92.</li> </ul>	ADP9000-110R
A9110525-01 (3rd party) *  (Order from Sinbon - USASales@sinbontech.com or by calling Tim Kehoe directly at (516) 658 1975)		MC90/MC91/MC92 External Scanner Cable	<ul style="list-style-type: none"> <li>Used to connect an external scanner like the LS3408 to the MC9x.</li> <li>Powered RS232/Serial connection to scanner.</li> <li>Does NOT provide enough current for DS3508-ER.</li> <li>Cable is NOT compatible with 3600 series scanners.</li> <li>Serial port not compatible with Android versions of MC92.</li> </ul>	ADP9000-110R
MDM9000-100R		MC90/MC91/MC92 56K External Modem	<ul style="list-style-type: none"> <li>Discontinued 10/2014</li> <li>Serial port not compatible with Android versions of MC92.</li> </ul>	ADP9000-100R
PSAK-UCM (3rd party) *  <a href="http://www.portsmith.com">http://www.portsmith.com</a>		Portsmith USB Modem Adapter	<ul style="list-style-type: none"> <li>Connects to MC9X00 via Single Slot USB cradle. Acts as USB Peripheral device to MC9X00 (USB host)</li> <li>Requires no separate power supply, operates on power draw directly from the USB connection.</li> <li>Kit includes PSA1U1M adapter and three USB cables for connecting to a variety of devices.</li> <li>Requires software driver from <a href="http://www.portsmith.com">http://www.portsmith.com</a></li> <li>Not compatible with Android versions of MC92.</li> </ul>	CRD9000-1001SR and USB Type B to Type B conversion cable 170575-000 (PortSmith cable included in kit) OR 25-62166-01R, ADP9000-100R and USB A receptacle to Type-B conversion cable.
PS6U1M (3rd party) *  <a href="http://www.portsmith.com">http://www.portsmith.com</a>		USB Modem Adapter 	<ul style="list-style-type: none"> <li>Connects to MC9x via Single Slot USB cradle or USB Cable</li> <li>Acts as USB Host device to MC9x (USB Peripheral)</li> <li>Requires driver for MC9x from PortSmith website</li> <li>Not compatible with Android versions of MC92.</li> </ul>	CRD9000-1001SR and 25-68596-01R OR 25-62166-01R and ADP9000-100R
PSAK-UCE-C (3rd party) *  <a href="http://www.portsmith.com">http://www.portsmith.com</a>		Portsmith USB Ethernet Adapter Kit for MC9300	<ul style="list-style-type: none"> <li>Connects to MC9300 via Single Slot USB cradle or Snap-On USB Cable.</li> <li>Requires no separate power supply, has grounded wiring from both the USB and Ethernet ports, and operates on very low power draw directly from the USB connection.</li> <li>Molded end caps enable the adapters to be aligned side by side or top to bottom, for efficient use of desktop space and organization of cables.</li> <li>Kit includes: PSA1U1E adapter and USB-C cable for connecting to the MC9300.</li> <li>Does not require any additional drivers on MC9300.</li> </ul>	MC9300 Charge/Communication Cradle (CRD-MC93-2SUCHG-01)  or MC9300 Charge/Communication Cable Adapter (CBL-MC93-USBCHG-01)

<p>PSAK-UCE (3rd party) *</p> <p><a href="http://www.portsmith.com">http://www.portsmith.com</a></p>		<p>Portsmith USB Ethernet Adapter Kit for MC91/MC92 series</p> 	<ul style="list-style-type: none"> <li>Connects to MC91/MC92 via Single Slot USB cradle. Acts as USB Peripheral device to MC91/MC92 (USB host)</li> <li>Requires no separate power supply, has grounded wiring from both the USB and Ethernet ports, and operates on very low power draw directly from the USB connection.</li> <li>Molded end caps enable the adapters to be aligned side by side or top to bottom, for efficient use of desktop space and organization of cables.</li> <li>Kit includes: PSA1U1E adapter and three USB cables for connecting to a variety of devices.</li> <li>Requires software driver from <a href="http://www.portsmith.com">http://www.portsmith.com</a></li> </ul>	<p>MC91/MC92 Single Slot Cradle (CRD9000-1001SR)</p>
<p>PSA1UH1E-12 (3rd party) *</p> <p><a href="http://www.portsmith.com">http://www.portsmith.com</a></p>		<p>Portsmith USB HOST Ethernet Adapter</p>	<ul style="list-style-type: none"> <li>Connects to MC9x via Single Slot USB cradle or USB Cable. Acts as USB Host device to MC9x (USB peripheral)</li> <li>Adapter can also power MC9x Single Slot Cradle with additional Portsmith power pass-through cable</li> <li>NOTE: PSAK-1UH1E-12 kit includes PSA1UH1E-12 Ethernet Adapter, Power Supply, Ethernet and USB Cables.</li> </ul>	<p>Portsmith USB Cables</p>
<p>PS6U1UHE (3rd party) *</p> <p><a href="http://www.portsmith.com">http://www.portsmith.com</a></p>		<p>USB Ethernet Adapter</p> 	<ul style="list-style-type: none"> <li>Discontinued, now use PSA1UH1E-12</li> <li>Connects to MC9x via Single Slot USB cradle or USB Cable.</li> <li>Acts as USB Host device to MC9x (USB peripheral)</li> <li>Includes Power Supply (190438-000LF) and USB Cable (170373-000).</li> </ul>	<p>CRD9000-1001SR and USB Mini A to Type B conversion cable 190087-002 (PortSmith cable) OR 25-62166-01R, ADP9000-100R and USB A receptacle to mini B conversion cable 190087-000 (PortSmith cable).</p>
<p>G1010 (3rd party) *</p> <p><a href="http://www.orbitgps.com/">http://www.orbitgps.com/</a></p>		<p>Serial GPS Receiver for MC90/MC91/MC92 and MC70</p>	<ul style="list-style-type: none"> <li>OrbitGPS's GPS Serial receiver is designed for use with Symbol vehicle docking cradles for handheld computers.</li> <li>The Serial GPS receiver features an external GPS antenna and a DB9 interface that is connected directly to the vehicle docking cradle. This allows GPS data to be transmitted to the handheld mobile computer when it is docked in the cradle.</li> <li>The Serial GPS receives power through a separate power adapter.</li> <li>Serial port not compatible with Android versions of MC92.</li> </ul>	
<p>170575-000 (3rd party) *</p> <p><a href="http://www.portsmith.com">http://www.portsmith.com</a></p>		<p>USB Cable: type-B plug to type-B plug</p>	<ul style="list-style-type: none"> <li>Allows the MC9x Single Slot Cradle to be connected to USB client peripherals like PortSmith's PSA1U1E USB Ethernet Adapter.</li> <li>Can also be used to connect to other peripherals with a mini USB-B connector.</li> <li>12 inch long cable</li> </ul>	
<p>FAUSB01 (3rd party) *</p> <p><a href="http://www.blackbox.com">http://www.blackbox.com</a></p>		<p>USB A Female to USB A Female adapter</p>	<ul style="list-style-type: none"> <li>Allows the MC909x to act as a USB host to connect to devices like USB flash drives, etc.</li> <li>This adapter works with the MC9x Cable Cup adapter.</li> </ul>	<p>25-62166-01R AND ADP9000-100R</p>

GXQU-06 (3rd party) * <a href="http://www.radioshack.com">http://www.radioshack.com</a>		JDI GoldX QuickConnect 5-in-1 USB Cable Kit (6 ft.)	<ul style="list-style-type: none"> <li>►Allows the MC909x to act as a USB host to connect to devices like USB flash drives, etc.</li> <li>►This cable works with the MC9x Single Slot cradle</li> <li>►Use a male B connector on one end and an A female connector on the other end.</li> </ul>	CRD9000-1001SR
3rd party * <a href="http://www.usbgear.net/item_15.html">http://www.usbgear.net/item_15.html</a>		USB A to USB B Converter	<ul style="list-style-type: none"> <li>►Allows the MC909x to act as a USB host to connect to devices like USB flash drives, etc.</li> <li>►This adapter works with the MC9x Single Slot cradle</li> </ul>	CRD9000-1001SR
KT-88330-03R (3 pack) ►Discontinued 9/2011  KT-88330-10R (10 pack) ►Discontinued 11/2011		ESD USB Adapter	<ul style="list-style-type: none"> <li>►Provides ESD protection when connecting device to PC.</li> </ul>	

### Snap-On Accessories

Part Number	Picture	Description	Notes	Required Items
CBL-MC93-USBCHG-01		MC9300 USB Communication/Charging Cable Adapter	<ul style="list-style-type: none"> <li>►Attaches to charge/communication port on bottom of MC9300.</li> <li>►Provides both USB communications and charging support.</li> <li>►Will charge battery in MC9300 from 0-90% in as little as 3.5 hours when used with USB Power Supply (PWR-WUA5V12W0xx)</li> <li>►Only compatible with MC9300.</li> </ul>	<ul style="list-style-type: none"> <li>►USB-C cable (CBL-TC5X-USBC2A-01 or CBL-TC2X-USBC-01) or similar 3rd party USB-C standard cable</li> <li>►USB charger...</li> </ul> <p><b>Indoor use:</b> order Country Specific version of USB Power Supply (PWR-WUA5V12W0xx)</p> <p><b>In Vehicle use:</b> USB Cigarette Lighter Adapter (CHG-AUTO-USB1-01)</p>
ADP9000-100R		MC90/MC91/MC92 Cable Adapter Module	<ul style="list-style-type: none"> <li>►Serial port not compatible with Android versions of MC92.</li> <li>►Not compatible with MC9300 devices.</li> <li>►This convenient and lightweight snap-on cable adapter provides the mechanism and the flexibility for cable communication, as well as auto charging capability.</li> </ul>	<p><u>For charging via AC wall outlet:</u></p> <ul style="list-style-type: none"> <li>►Power Supply (PWR-BGA12V50W0WW and CBL-DC-388A1-01) - or KIT-PWR-12V50W which includes both.</li> <li>►AC Line Cord (23844-00-00R)</li> </ul> <p><u>For charging in vehicle:</u> Cigarette Lighter Adapter (VCA9002-12R or VCA9000-24R)</p>
ADP9000-110R		MC90/MC91/MC92 Cable Adapter Module (5 V)	<ul style="list-style-type: none"> <li>►Provides 5 volt, 350 maH output for powering external scanners.</li> <li>►Does NOT provide enough current for DS3508-ER or DS3608-ER scanners.</li> <li>►Not compatible with MC9300 devices.</li> <li>►Serial port not compatible with Android versions of MC92.</li> </ul>	<p><u>For charging via AC wall outlet:</u></p> <ul style="list-style-type: none"> <li>►Power Supply (PWR-BGA12V50W0WW and CBL-DC-388A1-01) - or KIT-PWR-12V50W which includes both.</li> <li>►AC Line Cord (23844-00-00R)</li> </ul> <p><u>For charging in vehicle:</u> Cigarette Lighter Adapter (VCA9002-12R or VCA9000-24R)</p>

ADP9000-120R		MC90/MC91/MC92 Cable Adapter Module (USB Peripheral Charging)	<ul style="list-style-type: none"> <li>►Designed to work with Apriva's BT200 CAC reader.</li> <li>►Provides two USB connector leads (Red USB = PC/Charge Port to reader &amp; Black USB = PDA Port for reader communication)</li> <li>►Requires MC909X External Power Control Driver for WM 6.1 from Support Central.</li> <li>►Not compatible with MC9300 devices.</li> </ul>	<ul style="list-style-type: none"> <li>►SG-MC9027242-01R Operations Case</li> <li>►Apriva BT200 Bluetooth SmartCard Reader</li> </ul>
MSR9001-100R		MC90/MC91/MC92 Magnetic Stripe Reader	<ul style="list-style-type: none"> <li>►Discontinued 11/2011</li> <li>►Reads up to three tracks of information and can be programmed to divide, rearrange, edit and validate fields of entered data.</li> <li>►Also provides charging and communication.</li> <li>►Improved track three reading vs. MSR9000-100R</li> <li>►Not compatible with MC9300 devices.</li> <li>►Serial port not compatible with Android versions of MC92.</li> </ul>	<p><u>For charging via AC wall outlet:</u></p> <ul style="list-style-type: none"> <li>►Power Supply (PWR-BGA12V50W0WWW and CBL-DC-388A1-01) - or KIT-PWR-12V50W which includes both.</li> <li>►AC Line Cord (23844-00-00R)</li> </ul> <p><u>For charging in vehicle:</u></p> <p>Cigarette Lighter Adapter (VCA9002-12R or VCA9000-24R)</p>
MSR9000-100R		MC90/MC91/MC92 Magnetic Stripe Reader	<ul style="list-style-type: none"> <li>►Discontinued 5/2008 - replaced by MSR9001-100R</li> <li>►Reads up to three tracks of information and can be programmed to divide, rearrange, edit and validate fields of entered data.</li> <li>►Also provides charging and communication.</li> <li>►Not compatible with MC9300 devices.</li> <li>►Serial port not compatible with Android versions of MC92.</li> </ul>	<p><u>For charging via AC wall outlet:</u></p> <ul style="list-style-type: none"> <li>►Power Supply (PWR-BGA12V50W0WWW and CBL-DC-388A1-01) - or KIT-PWR-12V50W which includes both.</li> <li>►AC Line Cord (23844-00-00R)</li> </ul> <p><u>For charging in vehicle:</u></p> <p>Cigarette Lighter Adapter (VCA9002-12R or VCA9000-24R)</p>
Provided by TSL (3rd party) *  <a href="http://www.tsl.uk.com">http://www.tsl.uk.com</a> <a href="http://www.bluestarinc.com">http://www.bluestarinc.com</a>		MC90/MC91/MC92 GPS Module	<ul style="list-style-type: none"> <li>►8/2012 - No longer available</li> <li>►Provides simple upgrade path for standard MC9x terminal</li> <li>►Clip on attachment does not affect drop specification of MC9x terminal</li> <li>►Sealed to IP64 to match MC9x terminal</li> <li>►12 Channel tracking supported</li> <li>►Lightweight – 120g</li> <li>►Integral backup battery</li> <li>►A power supply jack is provided on the accessory so that the MC9x can be charged with the accessory connected.</li> <li>►The GPS unit uses the SiRFstarII chipset and has an integrated antenna.</li> <li>►Power is supplied by the MC9x and communication with the MC9x terminal is over the serial port.</li> <li>►Not compatible with MC9300 devices.</li> <li>►Serial port not compatible with Android versions of MC92.</li> </ul>	<p>Contact Jack Sheehan at Blue Star (800)354-9776 x3244</p>
G3090 (3rd party) *  <a href="http://www.orbitgps.com/">http://www.orbitgps.com/</a>		MC90/MC91/MC92 GPS Module	<ul style="list-style-type: none"> <li>►A power supply jack is provided on the accessory so that the MC9x can be charged with the accessory connected.</li> <li>►The GPS unit uses the SiRFstarII chipset and has an integrated antenna.</li> <li>►Power is supplied by the MC9x and communication with the MC9x terminal is over the serial port.</li> <li>►Not compatible with MC9300 devices.</li> <li>►Serial port not compatible with Android versions of MC92.</li> </ul>	

<p>1139-01-SO-MC9X00-CAC (3rd party) *</p> <p><a href="http://www.tsl.uk.com">http://www.tsl.uk.com</a></p> <p><a href="http://www.bluestarinc.com">http://www.bluestarinc.com</a></p>		<p>MC90/MC91/MC92 Contact Smart Card Reader</p> 	<ul style="list-style-type: none"> <li>▶ Reads Common Access Cards (CAC) as well as Smart Cards compliant with ISO7816-1,2,3,4.</li> <li>▶ Unit attaches semi-permanently to the base of the MC9x.</li> <li>▶ Communicates to MC9x via RS232 serial port</li> <li>▶ Provides DC charging jack for recharging MC9x (uses PWR-BGA12V50WOW, CBL-DC-388A1-01R power supply/DC Line Cord)</li> <li>▶ Includes Mini USB port for ActiveSync connections or other peripherals, such as printers (subject to suitable driver and USB host support on the terminal).</li> <li>▶ Not compatible with MC9300 devices.</li> <li>▶ Serial port not compatible with Android versions of MC92.</li> </ul>	
<p>Provided by TSL (3rd party) *</p> <p><a href="http://www.tsl.uk.com">http://www.tsl.uk.com</a></p> <p><a href="http://www.bluestarinc.com">http://www.bluestarinc.com</a></p>		<p>MC90/MC91/MC92 Contact Smart Card Reader with IrDA Support</p>	<ul style="list-style-type: none"> <li>▶ Provides a Smart Card and Memory card capability.</li> <li>▶ Unit attaches semi-permanently to the base of the MC9x.</li> <li>▶ Provides an IrDA port to enable infrared communications</li> <li>▶ Provides a 3-wire RS232 serial port</li> <li>▶ Communicates to MC9x via RS232 serial port</li> <li>▶ Provides DC charging jack for recharging MC9x.</li> <li>▶ Not compatible with MC9300 devices.</li> <li>▶ Serial port not compatible with Android versions of MC92.</li> </ul>	
<p>MDM9001-C010R</p>		<p>MC90/MC91/MC92 Snap-On Modem module</p>	<ul style="list-style-type: none"> <li>▶ Discontinued 12/2013</li> <li>▶ 56 Kbs speed</li> <li>▶ Provides AC power for operating the mobile computer and charging the battery in the mobile computer.</li> <li>▶ Provides for data communication between a mobile computer and a host computer, remotely through a phone line.</li> <li>▶ The modem module snaps onto the bottom of the mobile computer and can be easily removed when not in use.</li> <li>▶ Not compatible with MC9300 devices.</li> <li>▶ Serial port not compatible with Android versions of MC92.</li> </ul>	
<p>Provided by Northern Apex (3rd party) *</p> <p><a href="http://www.northernapex-rfid.com">http://www.northernapex-rfid.com</a></p>		<p>MC90/MC91/MC92 RFID (HF) Snap-On Module</p>	<ul style="list-style-type: none"> <li>▶ Reads/Writes ISO 15693 13.56 MHz tags</li> <li>▶ Powered from MC9x</li> <li>Provides AC power for operating the mobile computer and charging the battery in the mobile computer.</li> <li>▶ Can be used with an MC90xx-G RFID unit to read both UHF and HF tags</li> <li>▶ Not compatible with MC9300 devices.</li> <li>▶ Serial port not compatible with Android versions of MC92.</li> </ul>	
<b>Soft Goods - Cases/Holsters</b>				
<b>Part Number</b>	<b>Picture</b>	<b>Description</b>	<b>Notes</b>	<b>Required Items</b>

<p>SG-MC9X-SHLSTG-01</p>		<p>MC9x Gun Holster</p>	<ul style="list-style-type: none"> <li>▶Holster secures the MC9x-G on the user's waist and has the ability to also be used with a durable nylon adjustable belt or an adjustable nylon shoulder strap. (Belt and shoulder strap purchased separately).</li> <li>▶Ballistic nylon case</li> <li>▶Weep hole at bottom of case</li> <li>▶Compatible with all MC9x-Gun configurations, including MC9300. Not compatible with RFID devices though.</li> <li>▶Padding on side of Holster is slightly thicker than SG-MC9121112-01R.</li> <li>▶Compatible with MC9300 units using Rubber Boot (SG-MC93-RBTG-01), although the fit will be tight.</li> <li>▶Not compatible with MC90/MC91/MC92 devices using Rubber Boot (11-67218-04R).</li> </ul>	
<p>SG-MC9121112-01R</p>		<p>MC90/MC91/MC92 Gun Holster</p>	<ul style="list-style-type: none"> <li>▶Redesign of SG-MC90212110-01R to hold the terminal more snugly. The dimensions of the holster have been changed to give the mobile computer a more positive engagement when inserted in the holster</li> <li>▶Holster secures the MC9x-G on the user's waist and has the ability to also be used with a durable nylon adjustable belt or an adjustable nylon shoulder strap. (Belt and shoulder strap purchased separately).</li> <li>▶Ballistic nylon case</li> <li>▶Weep hole at bottom of case</li> <li>▶Can also be used with with MC9050-G or MC9060-G due to discontinuation of SG-MC90212110-01R.</li> <li>▶Not compatible with devices using Rubber Boot (11-67218-04R).</li> <li>▶Not compatible with MC9300 devices. Use SG-MC9X-SHLSTG-01 instead.</li> <li>▶Not compatible with with RFID devices.</li> </ul>	
<p>SG-MC90212110-01R</p>		<p>MC9x Gun Holster</p>	<ul style="list-style-type: none"> <li>▶Discontinued August 2010, now use SG-MC9121112-01R which now allows terminal to fit more securely in the holster while not sacrificing the ease of insertion or removal.</li> <li>▶Recommend using SG-MC9121112-01R for MC9090-G</li> <li>▶Holster secures the MC9x-G on the user's waist and has the ability to also be used with a durable nylon adjustable belt or an adjustable nylon shoulder strap. (Belt and shoulder strap purchased separately).</li> <li>▶Ballistic nylon case</li> <li>▶Weep hole at bottom of case</li> <li>▶Not compatible with MC9300 devices. Use SG-MC9X-SHLSTG-01 instead.</li> <li>▶Not compatible with with RFID devices.</li> </ul>	<p>Internal P/N 11-64896-02R</p>

<p>SG-MC9024242-01R</p>		<p>MC90/MC91/MC92 Gun Heated Boot</p>	<ul style="list-style-type: none"> <li>▶Allows Condensation Resistant terminal to be used in Freezer Applications.</li> <li>▶When paired with Condensation Resistant configurations of MC9x the Heated Boot will allow the terminal to function in freezer applications, extending its temperature range down to -30°C (-22°F).</li> <li>▶Insulated Case lined with heating element.</li> <li>▶Has space for Condensation Resistant MC9090 Gun Handle to extend out.</li> <li>▶Clear plastic top cover for display and keypad access.</li> <li>▶Scanner exit window for laser/imager configurations.</li> <li>▶Plastic battery case accommodating 4 commercially available AA standard or rechargeable batteries (AA batteries are used for heating the boot).</li> <li>▶Not compatible with MC9300</li> </ul>	<p>4 AA batteries</p>
<p>21-103560-01R</p>		<p>Spare Plastic Battery Well for MC90/MC91/MC92 Heated Boot</p>	<p>Allows AA batteries in Heated Boot (SG-MC9024242-01R) to be swapped faster.</p>	<p>SG-MC9024242-01R</p>
<p>SG-MC9027242-01R</p>		<p>MC909X Operations Case</p>	<ul style="list-style-type: none"> <li>▶Designed to work with Apriva's BT200 CAC reader.</li> <li>▶Holds BT200 and ADP9000-120R</li> </ul>	<ul style="list-style-type: none"> <li>▶ADP9000-120R Charge/Communication adapter</li> <li>▶Apriva BT200 Bluetooth SmartCard Reader</li> </ul>
<p>S5716DWSP (3rd party) *</p> <p><a href="http://www.ultimacase.com">http://www.ultimacase.com</a></p>		<p>Fabric Holster Assy with Waist Pad for MC90xx-G</p> 	<ul style="list-style-type: none"> <li>▶Ergonomically designed waist pad keeps the holster snug to body and prevents it from flopping while walking</li> <li>▶Holster is attached to the waist pad with a low profile D-swivel at top and hook &amp; loop at bottom</li> <li>▶Sleek vinyl lining inside the holster facilitates easy insertion and removal of the unit</li> <li>▶Retainer strap over handle prevents accidental drop of the unit</li> <li>▶A safety strap secures the unit to waist pad</li> <li>▶Exterior pocket is used for storing spare battery</li> <li>▶Designed for left or right handed users</li> </ul>	
<p>S5679DWSP (3rd party) *</p> <p><a href="http://www.ultimacase.com">http://www.ultimacase.com</a></p>		<p>Molded Polypro Holster with Pad and Belt for MC90xx RFID unit</p> 	<ul style="list-style-type: none"> <li>▶Custom molded polypropylene holster with wasit pad and belt for left or right handed user.</li> <li>▶Durable, wear resistant Ballistic Nylon waist pad.</li> <li>▶Safety strap for keeping the unit attached to waist pad.</li> <li>▶Waist pad with low profile D-swivel and hook &amp; loop keeps holster snug to body.</li> <li>▶2" wide heavy duty belt included</li> </ul>	











<p>A1232ST (3rd party) *</p> <p><a href="https://shilpitrading.com">https://shilpitrading.com</a></p>		<p>MC9xxx Gun Holster</p>	<ul style="list-style-type: none"> <li>•Foam Padded Soft Holster.</li> <li>•Belt Loops on sides for left or right handed users.</li> <li>•Belt Loop on back for attachment to rail.</li> <li>•D-rings for wearing with optional shoulder strap.</li> <li>•Retaining strap keeps device in holster to prevent accidental drops.</li> <li>•Can be used with optional Waist Belt for Holster (A1227ST) or Shoulder Strap (A1236ST)</li> </ul>	
<p>S5722DW (3rd party) *</p> <p><a href="http://www.ultimacase.com">http://www.ultimacase.com</a></p>		<p>Heated Case for MC90xx-G</p>	<ul style="list-style-type: none"> <li>•For use in environments that are colder than the MC90xx's operating specs.</li> <li>•Ballistic nylon OP Case is designed with Thinsulate padding for minimizing heat loss</li> <li>•Two pockets are sewn inside the case for storing Heat Packs that keep the unit warm</li> <li>•Heat Packs have temperature range of 104F to 156F (40C to 69C) and last up to 7 hours</li> <li>•See-thru polyurethane over front that will not crack or crease easily in cold weather environment</li> <li>•Concealed zipper and a flap over scanner window further minimize heat loss</li> <li>•3 D-rings, one on each side for attaching to an optional shoulder strap, and a third in the center for attaching to a retractor or a sling.</li> </ul>	<p>Requires heat packs which are also available on web site.</p>
<p>U6003DWSPROS2 (3rd party) *</p> <p><a href="http://www.ultimacase.com">http://www.ultimacase.com</a></p>		<p>Large Replacement Swivel Belt Clips for holsters</p> 		
<p>(3rd party) *</p> <p><a href="http://www.ultimacase.com">http://www.ultimacase.com</a></p>	<p>Agora Edge website</p>	<p>Additional Holsters for MC90xx series</p>		
<p>(3rd party) *</p> <p><a href="http://www.logisterra.com">http://www.logisterra.com</a></p>	<p>Logisterra website</p>	<p>Additional Holsters for MC90xx-Gun series</p>		
<p>11-08062-02R</p>		<p>Belt for holster</p>	<ul style="list-style-type: none"> <li>•Belt is 2 inches wide</li> <li>•Extends to 48 inches</li> <li>•Has improved buckle and softer belt material</li> </ul>	



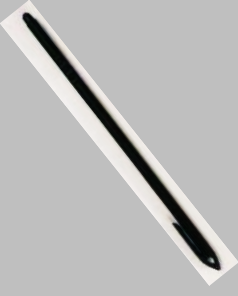

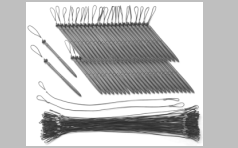
11-08062-01R		Belt for holster	<ul style="list-style-type: none"> <li>•Belt is 2 inches wide</li> <li>•Extends to 48 inches</li> <li>•Discontinued 9/2009, replaced by 11-08062-02R</li> </ul>	
A1227ST (3rd party) * <a href="https://www.shilpitrading.com">https://www.shilpitrading.com</a>		Belt for Holster	<ul style="list-style-type: none"> <li>•Belt is 2 inches wide</li> <li>•Extends to 48 inches</li> <li>•Quick on/off snap buckle</li> </ul>	
V6198DW (3rd party) * <a href="http://www.ultimacase.com">http://www.ultimacase.com</a>		Belt Extender	<ul style="list-style-type: none"> <li>•Used to extend the holster belt (11-08062-02R) an additional 10 inches</li> </ul>	
58-40000-007R		Shoulder Strap for MC90xx Gun Holster	<ul style="list-style-type: none"> <li>•1.5" wide, 22 to 50" max. length</li> </ul>	
A1236ST (3rd party) * <a href="https://www.shilpitrading.com">https://www.shilpitrading.com</a>		Universal Shoulder Strap	<ul style="list-style-type: none"> <li>•Belt is 1 inch wide</li> <li>•Extends to 54 inches</li> <li>•Moulded shoulder pad</li> <li>•Plastic swivel snap hooks</li> </ul>	
SG-MC93-RBTG-01		Rubber Boot for MC9300 Gun	<ul style="list-style-type: none"> <li>•Works with both Laser and Imager gun units</li> <li>•Devices with Boot will also fit into Gun Holster (SG-MC9X-SHLSTG-01). The fit will be tight though.</li> <li>•Only compatible with MC9300.</li> <li>•Does not increase drop spec of device. Designed to protect the device from the everyday nicks and dings.</li> <li>•Not compatible with Forklift Holder (MNT-MC93-FLCH-01).</li> <li>•Bottom portion of boot must be removed before inserting into Single Slot and Multi-Slot cradles.</li> </ul>	

11-67218-04R		Boot for MC90/MC91/MC92 Gun	•Not compatible with MC9300.	
KT-70147-01R		Belt Clip	Allows MC90xx Gun to be hooked onto the Belt Clip using the unit's handstrap	

**Misc**

Part Number	Picture	Description	Notes	Required Items
SG-MC93-HDSTPG-01		Handstrap for MC9300 Gun (single strap)	<ul style="list-style-type: none"> <li>•This is an optional handstrap, not included on MC9300 units.</li> <li>•Not compatible with MC90/MC91/MC92.</li> </ul>	
KT-66447-03R		Spare Handstrap for MC90/MC91/MC92 Gun (pack of 3)	•Not compatible with MC9300.	
SG-TC7X-STYLUS-03 (pack of 3)		MC9300 Stylus Kit with Tether	<ul style="list-style-type: none"> <li>•Only compatible with MC93</li> <li>•Includes fine-pitch, capacitive Stylus (SG-TC7X-STYLUS1-03) and coiled tether (KT-TC7X-TETHR1-03)</li> <li>•Conductive Carbon-filled plastic material w/ 5mm tip.</li> <li>•Length of stylus is 3.5".</li> <li>•Rigid plastic stylus is optimized for enterprise durability.</li> <li>•Clip &amp; tether point to reduce loss. Tether to Handstrap</li> <li>•When not being used stylus can be stored in loop on Handstrap or in the optional Holster</li> </ul>	

<p>SG-TC7X-STYEX1-3 (pack of 3)</p>		<p>MC9300 Extended Length Stylus</p>	<ul style="list-style-type: none"> <li>▶Discontinued 2/2019 - see PMB 10057</li> <li>▶Only compatible with MC93</li> <li>▶Conductive Carbon-filled plastic material w/ 5mm tip</li> <li>▶Rigid plastic stylus is optimized for enterprise durability.</li> <li>▶Clip &amp; tether point to reduce loss.</li> <li>▶When not being used stylus can be stored in optional Holster</li> <li>▶Use with optional Tether (SG-ET5X-SLTETR-01)</li> </ul>	
<p>KT-MC9X3X-STLSG-05 (pack of 5)</p> <p>KT-MC9X3X-STLSG-10 (pack of 10)</p> <p>KT-MC9X3X-STLSG-50 (pack of 50)</p>		<p>Spare Stylus for MC90/MC91/MC92 Gun</p>	<ul style="list-style-type: none"> <li>▶This is the standard stylus that ships with the unit.</li> <li>▶Not compatible with MC9300.</li> </ul>	
<p>KT-68144-10R (pack of 10)</p> <p>KT-68144-50R (pack of 50)</p>		<p>Spare Stylus for MC90/MC91/MC92 Gun</p>	<ul style="list-style-type: none"> <li>▶Discontinued 12/2017, now use KT-MC9X3X-STLSG-10 or MC9X3X-STLSG-50 - PMB 3057</li> <li>▶This is the standard stylus that ships with the unit.</li> <li>▶Not compatible with MC9300.</li> </ul>	
<p>KT-81680-03R (pack of 3)</p> <p>KT-81680-50R (pack of 50)</p>		<p>Tethered Stylus for MC90/MC91/MC92 Gun</p>	<ul style="list-style-type: none"> <li>▶Discontinued 12/2017, now use KT-MC9X3X-STLSG-05 or MC9X3X-STLSG-50 - PMB 3057</li> <li>▶Includes KT-68144-xx stylus and KT-73440-xx Tethers.</li> <li>▶Not compatible with MC9300.</li> </ul>	
<p>KT-TC7X-TETHR1-03 (pack of 3)</p>		<p>Replacement Coiled Tether for Stylus</p>	<ul style="list-style-type: none"> <li>▶This tether is included with Stylus Kit with Tether (SG-TC7X-STYLUS-03)</li> </ul>	
<p>SG-ET5X-SLTETR-01 (single)</p>		<p>Replacement Coiled Tether for Stylus</p>	<ul style="list-style-type: none"> <li>▶This tether is typically used with the ET5X series' stylus but can be used with MC9300 Stylus.</li> </ul>	
<p>KT-73440-01R</p>		<p>Non-Elastic Tethers for MC90/MC91/MC92 Gun Stylus or MC909x Brick/Short Stylus (pack of 3)</p>		



<p>11-42722-03R (pack of 3) 11-42722-50R (pack of 50)</p>		<p>Elastic Tethers</p>		
<p>MISC-MC93-SCRN-01 (pack of 5)</p>		<p>MC9300 Tempered Glass Screen Protector (pack of 5)</p>	<ul style="list-style-type: none"> <li>▶Tempered glass</li> <li>▶Includes alcohol wipes, cleaning cloth, and tools needed for screen protector installation.</li> </ul>	
<p>KT-151827-03R (pack of 3) KT-151827-500R (pack of 500)</p>		<p>MC90/MC91/MC92 Screen Protector/Guard</p>	<ul style="list-style-type: none"> <li>▶Adds self aligning feature to avoid unintentional activation of the touch panel display.</li> <li>▶For use with applications with high touch screen usage, Symbol recommends the use of a screen protector to minimize wear and tear.</li> <li>▶Screen protectors enhance the usability and durability of touch screen displays.</li> <li>▶Benefits include: <ul style="list-style-type: none"> <li>- Protection from scratches and gouges</li> <li>- Durable writing and touch surface with tactile feel</li> <li>- Abrasion and chemical resistance</li> <li>- Glare reduction</li> <li>- Keeping the device's screen looking like new</li> </ul> </li> </ul>	
<p>KT-93176-03R</p>		<p>MC90/MC91/MC92 Screen Protector/Guard (pack of 3)</p>	<ul style="list-style-type: none"> <li>▶Discontinued 1/2012 - now use KT-151827-03R</li> <li>▶Adds self aligning feature to avoid unintentional activation of the touch panel display.</li> <li>▶For use with applications with high touch screen usage, Symbol recommends the use of a screen protector to minimize wear and tear.</li> <li>▶Screen protectors enhance the usability and durability of touch screen displays.</li> <li>▶Benefits include: <ul style="list-style-type: none"> <li>- Protection from scratches and gouges</li> <li>- Durable writing and touch surface with tactile feel</li> <li>- Abrasion and chemical resistance</li> <li>- Glare reduction</li> <li>- Keeping the device's screen looking like new</li> </ul> </li> </ul>	
<p>KT-68638-01R</p>		<p>MC90/MC91/MC92 Screen Protector/Guard (pack of 3)</p>	<ul style="list-style-type: none"> <li>▶Discontinued 5/2008 - replaced by KT-93176-03R</li> <li>▶For use with applications with high touch screen usage, Symbol recommends the use of a screen protector to minimize wear and tear.</li> <li>▶Screen protectors enhance the usability and durability of touch screen displays.</li> <li>▶Benefits include: <ul style="list-style-type: none"> <li>- Protection from scratches and gouges</li> <li>- Durable writing and touch surface with tactile feel</li> <li>- Abrasion and chemical resistance</li> <li>- Glare reduction</li> <li>- Keeping the device's screen looking like new</li> </ul> </li> </ul>	



<p>Additional Screen Protectors (3rd party) *</p> <p><a href="http://www.nushield.com">http://www.nushield.com</a></p>		<p>Additional Screen Protectors</p>	<ul style="list-style-type: none"> <li>•NuShield AG™ - works well indoors under bright lights to minimize glare.</li> <li>•NuShield AM™ - antimicrobial film is an antiglare film designed for hospitals, public kiosks, restaurants and POS terminals where transmission of disease is a primary concern.</li> <li>•NuShield DayVue™ - antireflective film is the best choice for displays that are being used outdoors.</li> </ul>	
--	--	-------------------------------------	--	--

**Vehicle/Forklift Cradles and Holders**



**Powered Cradles and Holders (provides device charging and/or communication)**

Part Number	Picture	Description	Notes	Required Items
<p>FLC9000-1001R</p>		<p>MC90/MC91/MC92 Fork Lift Cradle</p>	<ul style="list-style-type: none"> <li>•Designed to withstand extreme vibration and shock</li> <li>•Cradle can be used with or without external power</li> <li>•One finger push button allows one-handed removal of terminal from the cradle.</li> <li>•Locking tab can be used to prevent removal of terminal from the cradle.</li> <li>•Cradle provides rugged amphenol powered RS232 and USB connections (i.e. for tethered scanner) which are the same as the ports on the VC5090.</li> <li>•Ports do not provide enough current for DS3508-ER or DS3608-ER in default power mode (DS3608 will need to use ER Low Power option to work properly).</li> <li>•Cradle requires external power source for USB port to be operational</li> <li>•Includes bracket that can be mounted on the left or right side of the cradle.</li> <li>•D-sized or larger RAM Mount can also be used for greater flexibility during installation</li> <li>•Includes tethered stylus with stylus storage location (uses same stylus as MC9090-G).</li> <li>•Not compatible with MC9300 or MC90xx-R (RFID) devices.</li> <li>•Serial port not compatible with Android versions of MC92.</li> </ul>	<p><b>To Power Cradle:</b></p> <ul style="list-style-type: none"> <li>•Fork Lift Power Converter (50-14000-251R/PWRS-14000-251R for high voltage vehicles OR 50-14000-252R/PWRS-14000-252R for lower voltage vehicles)</li> <li>•Fork Lift Cradle Power Cable (25-103872-02R)</li> </ul> <p><b>For tethered LS3408 scanner:</b></p> <ul style="list-style-type: none"> <li>•RS232 Scanner Cable (25-71917-03R) OR</li> <li>•USB Scanner Cable (CBL-71918-12R/25-71918-01R)</li> </ul>

<p>FLC9000-1000R</p>		<p>MC90xx Fork Lift Cradle</p>	<ul style="list-style-type: none"> <li>•Discontinued 2/8/2012, now use FLC9000-1001R.</li> <li>•Designed to withstand extreme vibration and shock</li> <li>•Cradle can be used with or without external power</li> <li>•One finger push button allows one-handed removal of terminal from the cradle.</li> <li>•Locking tab can be used to prevent removal of terminal from the cradle.</li> <li>•Cradle provides rugged amphenol powered RS232 and USB connections (i.e. for tethered scanner) which are the same as the ports on the VC5090.</li> <li>•Ports do not provide enough current for DS3508-ER or DS3608-ER in default power mode (DS3608 will need to use ER Low Power option to work properly).</li> <li>•Cradle requires external power source for USB port to be operational</li> <li>•Includes bracket that can be mounted on the left or right side of the cradle.</li> <li>•D-sized or larger RAM Mount can also be used for greater flexibility during installation</li> <li>•Includes tethered stylus with stylus storage location (uses same stylus as MC9090-G).</li> <li>•Not compatible with MC9300 or MC90xx-R (RFID) devices.</li> <li>•Serial port not compatible with Android versions of MC92.</li> </ul>	<p><b>To Power Cradle:</b></p> <ul style="list-style-type: none"> <li>•Fork Lift Power Converter (50-14000-251R/PWRS-14000-251R for high voltage vehicles OR 50-14000-252R/PWRS-14000-252R for lower voltage vehicles)</li> <li>•Fork Lift Cradle Power Cable (25-103872-01R)</li> </ul> <p><b>For tethered LS3408 scanner:</b></p> <ul style="list-style-type: none"> <li>•RS232 Scanner Cable (25-71917-03R)</li> <li>OR</li> <li>•USB Scanner Cable (CBL-71918-12R/25-71918-01R)</li> </ul>
<p>KT-FLC9000-HV</p>		<p>MC90/MC91/MC92 Fork Lift Cradle Kit (High Voltage)</p>	<ul style="list-style-type: none"> <li>•For 36, 48, 60 nominal VDC vehicles</li> <li>•Includes FLC9000-1001R, PWRS-14000-251R and 25-103872-02R</li> <li>•Designed to withstand extreme vibration and shock</li> <li>•Cradle can be used with or without external power</li> <li>•One finger push button allows one-handed removal of terminal from the cradle.</li> <li>•Locking tab can be used to prevent removal of terminal from the cradle.</li> <li>•Cradle provides rugged amphenol powered RS232 and USB connections (i.e. for tethered scanner) which are the same as the ports on the VC5090.</li> <li>•Ports do not provide enough current for DS3508-ER or DS3608-ER in default power mode (DS3608 will need to use ER Low Power option to work properly).</li> <li>•Cradle requires external power source for USB port to be operational</li> <li>•Includes bracket that can be mounted on the left or right side of the cradle.</li> <li>•D-sized or larger RAM Mount can also be used for greater flexibility during installation</li> <li>•Includes tethered stylus with stylus storage location (uses same stylus as MC9090-G).</li> <li>•Energy Star Compliant</li> <li>•Not compatible with MC9300 or MC90xx-R (RFID) devices.</li> <li>•Serial port not compatible with Android versions of MC92.</li> </ul>	<p><b>For tethered LS3408 scanner:</b></p> <ul style="list-style-type: none"> <li>•RS232 Scanner Cable (25-71917-03R)</li> <li>OR</li> <li>•USB Scanner Cable (CBL-71918-12R/25-71918-01R)</li> </ul>

<p>FLC9000-101ES</p>		<p>MC90/MC91/MC92 Fork Lift Cradle Kit (High Voltage)</p>	<ul style="list-style-type: none"> <li>•For 36, 48, 60 nominal VDC vehicles</li> <li>•Includes PWRS-14000-251R and 25-103872-01R</li> <li>•Designed to withstand extreme vibration and shock</li> <li>•Cradle can be used with or without external power</li> <li>•One finger push button allows one-handed removal of terminal from the cradle.</li> <li>•Locking tab can be used to prevent removal of terminal from the cradle.</li> <li>•Cradle provides rugged amphenol powered RS232 and USB connections (i.e. for tethered scanner) which are the same as the ports on the VC5090.</li> <li>•Ports do not provide enough current for DS3508-ER or DS3608-ER in default power mode (DS3608 will need to use ER Low Power option to work properly).</li> <li>•Cradle requires external power source for USB port to be operational</li> <li>•Includes bracket that can be mounted on the left or right side of the cradle.</li> <li>•D-sized or larger RAM Mount can also be used for greater flexibility during installation</li> <li>•Includes tethered stylus with stylus storage location (uses same stylus as MC9090-G).</li> <li>•Energy Star Compliant</li> <li>•Discontinued 2/8/2012, now use KT-FLC9000-HV.</li> <li>•Not compatible with MC9300 or MC90xx-R (RFID) devices.</li> <li>•Serial port not compatible with Android versions of MC92.</li> </ul>	<p><b>For tethered LS3408 scanner:</b></p> <ul style="list-style-type: none"> <li>•RS232 Scanner Cable (25-71917-03R)</li> <li>OR</li> <li>•USB Scanner Cable (CBL-71918-12R/25-71918-01R)</li> </ul>
<p>FLC9000-101R</p>		<p>MC90/MC91/MC92 Fork Lift Cradle Kit (High Voltage)</p>	<ul style="list-style-type: none"> <li>•For 36, 48, 60 nominal VDC vehicles</li> <li>•Includes 50-14000-251R and 25-103872-01R</li> <li>•Does not work with MC90xx-R (RFID).</li> <li>•Designed to withstand extreme vibration and shock</li> <li>•Cradle can be used with or without external power</li> <li>•One finger push button allows one-handed removal of terminal from the cradle.</li> <li>•Locking tab can be used to prevent removal of terminal from the cradle.</li> <li>•Cradle provides rugged amphenol powered RS232 and USB connections (i.e. for tethered scanner) which are the same as the ports on the VC5090.</li> <li>•Ports do not provide enough current for DS3508-ER or DS3608-ER in default power mode (DS3608 will need to use ER Low Power option to work properly).</li> <li>•Cradle requires external power source for USB port to be operational</li> <li>•Includes bracket that can be mounted on the left or right side of the cradle.</li> <li>•D-sized or larger RAM Mount can also be used for greater flexibility during installation</li> <li>•Includes tethered stylus with stylus storage location (uses same stylus as MC9090-G).</li> <li>•Discontinued 12/2010 - replaced by FLC9000-101ES.</li> <li>•Serial port not compatible with Android versions of MC92.</li> <li>•Not compatible with MC9300 devices.</li> </ul>	<p><b>For tethered LS3408 scanner:</b></p> <ul style="list-style-type: none"> <li>•RS232 Scanner Cable (25-71917-03R)</li> <li>OR</li> <li>•USB Scanner Cable (CBL-71918-12R/25-71918-01R)</li> </ul>



<p>KT-FLC9000-LV</p>		<p>MC90/MC91/MC92 Fork Lift Cradle Kit (Low Voltage)</p>	<ul style="list-style-type: none"> <li>▶For 12, 24 nominal VDC vehicles</li> <li>▶Includes FLC9000-1001R, PWRS-14000-252R and 25-103872-02R</li> <li>▶Designed to withstand extreme vibration and shock</li> <li>▶Cradle can be used with or without external power</li> <li>▶One finger push button allows one-handed removal of terminal from the cradle.</li> <li>▶Locking tab can be used to prevent removal of terminal from the cradle.</li> <li>▶Cradle provides rugged amphenol powered RS232 and USB connections (i.e. for tethered scanner) which are the same as the ports on the VC5090.</li> <li>▶Ports do not provide enough current for DS3508-ER or DS3608-ER in default power mode (DS3608 will need to use ER Low Power option to work properly).</li> <li>▶Cradle requires external power source for USB port to be operational</li> <li>▶Includes bracket that can be mounted on the left or right side of the cradle.</li> <li>▶D-sized or larger RAM Mount can also be used for greater flexibility during installation</li> <li>▶Includes tethered stylus with stylus storage location (uses same stylus as MC9090-G).</li> <li>▶Energy Star Compliant.</li> <li>▶Not compatible with MC9300 or MC90xx-R (RFID) devices.</li> <li>▶Serial port not compatible with Android versions of MC92.</li> </ul>	<p><b>For tethered LS3408 scanner:</b></p> <ul style="list-style-type: none"> <li>▶RS232 Scanner Cable (25-71917-03R)</li> <li>OR</li> <li>▶USB Scanner Cable (CBL-71918-12R/25-71918-01R)</li> </ul>
<p>FLC9000-102ES</p>		<p>MC90/MC91/MC92 Fork Lift Cradle Kit (Low Voltage)</p>	<ul style="list-style-type: none"> <li>▶For 12, 24 nominal VDC vehicles</li> <li>▶Includes PWRS-14000-252R and 25-103872-01R</li> <li>▶Designed to withstand extreme vibration and shock</li> <li>▶Cradle can be used with or without external power</li> <li>▶One finger push button allows one-handed removal of terminal from the cradle.</li> <li>▶Locking tab can be used to prevent removal of terminal from the cradle.</li> <li>▶Cradle provides rugged amphenol powered RS232 and USB connections (i.e. for tethered scanner) which are the same as the ports on the VC5090.</li> <li>▶Ports do not provide enough current for DS3508-ER or DS3608-ER in default power mode (DS3608 will need to use ER Low Power option to work properly).</li> <li>▶Cradle requires external power source for USB port to be operational</li> <li>▶Includes bracket that can be mounted on the left or right side of the cradle.</li> <li>▶D-sized or larger RAM Mount can also be used for greater flexibility during installation</li> <li>▶Includes tethered stylus with stylus storage location (uses same stylus as MC9090-G).</li> <li>▶Energy Star Compliant</li> <li>▶Discontinued 2/8/2012, now use KT-FLC9000-LV</li> <li>▶Serial port not compatible with Android versions of MC92.</li> <li>▶Not compatible with MC9300 or MC90xx-R (RFID) devices.</li> </ul>	<p><b>For tethered LS3408 scanner:</b></p> <ul style="list-style-type: none"> <li>▶RS232 Scanner Cable (25-71917-03R)</li> <li>OR</li> <li>▶USB Scanner Cable (CBL-71918-12R/25-71918-01R)</li> </ul>

<p>FLC9000-102R</p>		<p>MC90/MC91/MC92 Fork Lift Cradle Kit (Low Voltage)</p>	<ul style="list-style-type: none"> <li>•For 12, 24 nominal VDC vehicles</li> <li>•Includes 50-14000-252R and 25-103872-01R</li> <li>•Designed to withstand extreme vibration and shock</li> <li>•Cradle can be used with or without external power</li> <li>•One finger push button allows one-handed removal of terminal from the cradle.</li> <li>•Locking tab can be used to prevent removal of terminal from the cradle.</li> <li>•Cradle provides rugged amphenol powered RS232 and USB connections (i.e. for tethered scanner) which are the same as the ports on the VC5090.</li> <li>•Ports do not provide enough current for DS3508-ER or DS3608-ER in default power mode (DS3608 will need to use ER Low Power option to work properly).</li> <li>•Cradle requires external power source for USB port to be operational</li> <li>•Includes bracket that can be mounted on the left or right side of the cradle.</li> <li>•D-sized or larger RAM Mount can also be used for greater flexibility during installation</li> <li>•Includes tethered stylus with stylus storage location (uses same stylus as MC9090-G).</li> <li>•Discontinued 12/2010 - replaced by FLC9000-102ES.</li> <li>•Not compatible with MC9300 or MC90xx-R (RFID) devices.</li> <li>•Serial port not compatible with Android versions of MC92.</li> </ul>	<p><b>For tethered LS3408 scanner:</b></p> <ul style="list-style-type: none"> <li>•RS232 Scanner Cable (25-71917-03R)</li> <li>OR</li> <li>•USB Scanner Cable (CBL-71918-12R/25-71918-01R)</li> </ul>
<p>VM9000C (3rd party) *</p> <p><a href="http://www.general-data.com">http://www.general-data.com</a></p>		<p>MC90/MC91/MC92 Gun Vehicle Mount Cradle and Charging Station</p>	<ul style="list-style-type: none"> <li>•Provides constant on-board charging for the MC9x-G.</li> <li>•Mounts directly to a forklift or cab of any warehouse vehicle.</li> <li>•Draws power from the vehicle's battery or other power supply.</li> <li>•Secures the MC9x-G in a cradle to protect from damage.</li> <li>•Enables the MC9x-G to be used as a vehicular-mounted device.</li> <li>•Cradle uses the ADP9000-110, so it will power a tethered scanner attached to port on the cradle.</li> <li>•Available in 12V or 24V/48V configurations.</li> <li>•Not compatible with MC9300 devices.</li> <li>•Serial port not compatible with Android versions of MC92.</li> </ul>	<p>A9110525-01 if attaching a tethered scanner</p>
<p><b>Un-Powered Cradles and Holders (passive holders, no charging support)</b></p>				
Part Number	Picture	Description	Notes	Required Items
<p>MNT-MC93-FLCHKT-01</p>		<p>MC9X Forklift Holder KIT (passive - unpowered)</p>	<ul style="list-style-type: none"> <li>•Bracket holds MC9X for convenient mounting on fork lift.</li> <li>•Installs on a roll bar or square surface of the forklift and allows the device to be used in landscape or portrait mode.</li> <li>•Kit includes MC9X Forklift Holder (MNT-MC93-FLCH-01), RAM Mount Arm for Fork Lift Cradle (MNT-RAM-B201U) and RAM Mount Base for Fork Lift Cradle (MNT-RAM-B247U25)</li> <li>•Does NOT provide device charging.</li> <li>•Not compatible with devices with rubber boot attached.</li> <li>•Compatible with all MC9X configurations (including MC9300). Not compatible with RFID devices though.</li> </ul>	



<p>MNT-MC93-FLCH-01</p>		<p>MC9X Forklift Holder (passive - unpowered)</p>	<ul style="list-style-type: none"> <li>•Bracket holds MC9X for convenient mounting on fork lift.</li> <li>•Installs on a roll bar or square surface of the forklift and allows the device to be used in landscape or portrait mode.</li> <li>•Includes RAM B size ball (1" diameter) on back of holder.</li> <li>•Does NOT provide device charging.</li> <li>•Not compatible with devices with rubber boot attached.</li> <li>•Compatible with all MC9X configurations (including MC9300). Not compatible with RFID devices though.</li> </ul>	
<p>MNT-RAM-B201U</p>		<p>RAM Mount Arm for MC9X00 Fork Lift Cradle</p>	<ul style="list-style-type: none"> <li>•Used with Fork Lift Holder (MNT-MC93-FLCH-01)</li> <li>•RAM Double Sock Arm for 1" ball (B size)</li> <li>•Uses RAM Mount P/N RAM-B-201U</li> </ul>	
<p>MNT-RAM-B247U25</p>		<p>RAM Mount Base for MC9X00 Fork Lift Cradle</p>	<ul style="list-style-type: none"> <li>•Used with Fork Lift Holder (MNT-MC93-FLCH-01)</li> <li>•Attaches to square shaped rail/post of forklift.</li> <li>•2.5" Max Width Square Rail Base with 1" diameter ball (B size)</li> <li>•Uses RAM Mount P/N RAM-B-247U-25</li> </ul>	
<p>710134 (Standard holder)</p> <p>710135 (Holder with Swiveling Top Support)</p> <p>(3rd party) *</p> <p><a href="http://www.proclipusa.com/category/zebra">http://www.proclipusa.com/category/zebra</a></p>		<p>ProClip MC9300 Vehicle Mount Holder (unpowered)</p>	<ul style="list-style-type: none"> <li>•Holds MC9300 devices, not compatible with MC90/MC91/MC92.</li> <li>•Front Facing - allows user to access screen and keyboard while cradled.</li> <li>•Mount ready via AMPS hole pattern to ProClip pedestal or forklift mounts.</li> <li>•Fits devices with or without hand strap attached.</li> </ul>	<p>Mount on vehicle using ProClip Pedestal or Forklift Mount - see ProClip website</p>





<p>241483 (Mounting Plate only)</p> <p>241482 (Mounting Plate with vibration damper)</p> <p>(3rd party) *</p> <p><a href="http://www.proclipusa.com/category/zebra">http://www.proclipusa.com/category/zebra</a></p>		<p>ProClip MC90/MC91/MC92 Gun Vehicle Mount Holder (unpowered)</p>	<ul style="list-style-type: none"> <li>•Holds MC90/MC91/MC92 Gun devices, not compatible with MC9300.</li> <li>•Front Facing - allows user to access screen and keyboard while cradled.</li> <li>•Variable Mount - can be tilted and swiveled.</li> <li>•Mount ready via AMPS hole pattern to ProClip pedestal or forklift mounts.</li> <li>•CNC machined from rugged ACETAL/DELTRIN plastic</li> <li>•Version with vibration damper recommended for forklift mounting.</li> </ul>	<p>Mount on vehicle using ProClip Pedestal or Forklift Mount - see ProClip website</p>
<p>KT-67075-01</p>		<p>Fork Truck Holster</p>	<ul style="list-style-type: none"> <li>•Used to mount MC9x Gun on fork truck or other vehicle.</li> <li>•Includes MC90xx Gun Boot (11-67218-04).</li> <li>•Discontinued 12/31/05</li> </ul>	
<p>RAP-450U</p> <p>(3rd party) *</p> <p><a href="https://www.rammount.com">https://www.rammount.com</a></p>		<p>RAM Power-Grip™ XL Universal Scanner Gun Holder</p>	<ul style="list-style-type: none"> <li>•Universal scanner gun holder is designed for use with several large form factor scanner guns.</li> <li>•Compatible with a full range of ball and socket forklift mounting systems.</li> <li>•Uses high-strength composite materials.</li> <li>•Holder features two attachment points: (1) the hole pattern on the back of the holder allows for the connection of the RAM-202U or the RAM-D-254U (hardware is included for these attachments) or (2) the hole pattern on the bottom of the holder allows for the connection of a 2" x 3" plate – RAM-202U-23 or RAM-D-202U-23 – or a drill-down mount (hardware is not included for these attachments).</li> </ul>	
<p>Y6911DWSP (formerly S5691DWSP)</p> <p>(3rd party) *</p> <p><a href="http://www.ultimacase.com">http://www.ultimacase.com</a></p>		<p>Wall Mountable/Fork lift Mountable Holster for MC9xxx-G</p> 	<ul style="list-style-type: none"> <li>•Mounting holes reinforced with grommets for 3 mounting options: back, left side, or right side.</li> <li>•Stiffeners in all walls provide structure and rigidity for forklift or wall mount.</li> <li>•Sleek vinyl lining inside for easy insertion and removal of the unit.</li> <li>•Retainer strap over handle to prevent accidental drops.</li> <li>•Pocket on each side for marker/pen</li> </ul>	

<p>A1233ST (3rd party) *</p> <p><a href="https://shilpitrading.com">https://shilpitrading.com</a></p>		<p>Wall Mountable/Fork lift Mountable Holster for MC9xxx-G</p>	<ul style="list-style-type: none"> <li>▶ Grommetted holes on 3-sides for multiple mounting options. Includes two plastic cable tie-wraps.</li> <li>▶ Two pockets for keeping markers.</li> <li>▶ Stiffeners for structure and rigidity.</li> <li>▶ Retaining strap keeps device in holster to prevent accidental drops.</li> </ul>	
<p>V6177DWSP (3rd party) *</p> <p><a href="http://www.ultimacase.com">http://www.ultimacase.com</a></p>		<p>Molded Polypro Holster with Metal Bracket for Forklift or Vehicle Mounting for MC90xx-G or MC90xx RFID</p> 	<ul style="list-style-type: none"> <li>▶ Rugged Polypropylene holster is resistant to many chemicals.</li> <li>▶ Metal bracket facilitates mounting to a forkltruck or other flat surfaces.</li> </ul>	
<p>V6177DWSPWRAM (3rd party) *</p> <p><a href="http://www.ultimacase.com">http://www.ultimacase.com</a></p>		<p>Molded Polypro Holster with Metal Bracket and RAM mount for Forklift or Vehicle Mounting for MC90xx-G or MC90xx RFID</p> 	<ul style="list-style-type: none"> <li>▶ Rugged Polypropylene holster is resistant to many chemicals.</li> <li>▶ Metal bracket facilitates mounting to a forkltruck or other flat surfaces.</li> <li>▶ RAM mount facilitates multiple mounting options and viewing angles</li> </ul>	
<p>SY-VM90G-TOP (3rd party) *</p> <p><a href="http://www.logisterra.com">http://www.logisterra.com</a></p>		<p>MC9x Gun Vehicle Mount Cradle</p>		
<p>00-8053SP (3rd party) *</p> <p><a href="http://www.ultimacase.com">http://www.ultimacase.com</a></p>		<p>Kydex Holster w/Metal Bracket for MC90xx Gun, Brick, or Short</p>	<ul style="list-style-type: none"> <li>▶ Custom molded ruggedized Kydex plastic holster for industrial application.</li> <li>▶ A metal bracket is fastened to holster which allows mounting to a Fork truck or other rigid surfaces</li> <li>▶ Metal bracket facilitates the holster to swing for operating the unit in multiple positions.</li> </ul>	





<p>7160-0854 (3rd party) *</p> <p><a href="https://www.gamberjohnson.com">https://www.gamberjohnson.com</a></p>		<p>Gamber-Johnson Barcode Scanner/Mobile Computer Mount</p>	<ul style="list-style-type: none"> <li>▶Attaches to the overhead guard leg on forklift trucks. It is designed to fit rectangular pillars between 1.5" to 2.5" wide with easy installation</li> <li>▶Heavy gauge steel construction for long-term durability in a rugged environment.</li> <li>▶Black powdercoat finish for maximum corrosion resistance.</li> <li>▶Designed to securely fit most handheld barcode scanners and mobile computers.</li> <li>▶Works with wireless and wired devices.</li> </ul>	
<p>7160-1306 (3rd party) *</p> <p><a href="https://www.gamberjohnson.com">https://www.gamberjohnson.com</a></p>		<p>Gamber-Johnson Scanner Pocket Mount with Small Back Plate</p>	<ul style="list-style-type: none"> <li>▶Scanner mount is designed to support scanner or handheld computer in a rugged environment by holding it securely to the overhead guard leg of fork lift vehicle.</li> <li>▶Adjustable in width, and offers 3 mounting orientations from the overhead guard leg or one of Gamber-Johnson's extension bars.</li> <li>▶Designed to hold most handheld computers and scanners.</li> <li>▶Adjustable to fit 3.5" to 4.5" width and set at 2.5" tall</li> <li>▶Designed to be orientated inside, outside, or inline with the overhead guard leg.</li> <li>▶Attaches to rectangular overhead guard legs that are 1.5 in to 2.5 in (3.81 cm to 6.35 cm) wide.</li> </ul>	
<p>SG-MOT-90-BT or SG-MOT-90-BT (for Gun units with attached rubber boot - 11-67218-04R) (3rd party) *</p> <p><a href="http://www.smart-grip.com">http://www.smart-grip.com</a></p>		<p>MC9x Gun or Brick Vehicle Mount Cradle</p>	<ul style="list-style-type: none"> <li>▶Can be used on forklifts, carts, work benches, etc.</li> <li>▶Readable screen while in holder</li> <li>▶Useable Keyboard while in Holder</li> <li>▶Fully Adjustable Mounting</li> <li>▶Open End Supports Adapter and Cables</li> <li>▶Angled Fingers Support Terminal</li> <li>▶Angle and Tapered Sides for Secure Support</li> <li>▶All Steel Construction</li> <li>▶Supports RFID configurations also.</li> </ul>	
<p>127 - 12 12 Volt Heated holder 127 - 24 24 Volt Heated holder 127 - 3648 36 - 48 Volt Heated holder (3rd party) *</p> <p><a href="http://www.jlcsolutions.biz">http://www.jlcsolutions.biz</a></p>		<p>MC9x Gun Heated Vehicle Mount holster/holder</p>	<ul style="list-style-type: none"> <li>▶Eliminates the "Fogging" and "Freezing" on the laser scanner lens and on the terminal's display screen caused by temperature and humidity changes.</li> <li>▶This is accomplished by placing two thermostatically controlled heating pads designed to put the right amount of heat at both key points.</li> <li>▶Can be used on forklifts, carts, work benches, etc.</li> </ul>	
<p>(3rd party) *</p> <p><a href="http://www.ultimacase.com">http://www.ultimacase.com</a></p>	<p>Agora Edge website</p>	<p>Additional Vehicle Holders/Cradles for MC90xx series</p>		





**Headset/Audio Accessories**





Part Number	Picture	Description	Notes	Required Items
HS2100-OTH		HS2100 Rugged Wired Headset (Over the Head headband)	<ul style="list-style-type: none"> <li>•Built to handle the everyday inevitable drops</li> <li>•Dustproof, sprayproof and waterproof</li> <li>•Ready for the freezer and outdoor subzero temperatures</li> <li>•Feather-light for extraordinary comfort</li> <li>•Noise cancellation for a superior voice experience in the noisiest environments</li> <li>•Detachable swivel boom minimizes costs.</li> <li>•Swivelling boom mutes microphone allowing uses to prevent voice pick applications from recognizing non-voice pick conversations.</li> <li>•User-replaceable pads and windscreens maximize comfort and hygiene.</li> <li>•Not compatible with MC9300 which doesn't include a headset jack. Use a Bluetooth headset (HS3100) instead.</li> </ul>	<ul style="list-style-type: none"> <li>•Quick Disconnect Headset cable (CBL-HS2100-QDC1-02)</li> <li>•Headset Adapter Cable (25-124387-02R)</li> </ul>
HS2100-BTN-L		HS2100 Rugged Wired Headset (Behind the Neck Left headband)	<ul style="list-style-type: none"> <li>•Built to handle the everyday inevitable drops</li> <li>•Dustproof, sprayproof and waterproof</li> <li>•Ready for the freezer and outdoor subzero temperatures</li> <li>•Feather-light for extraordinary comfort</li> <li>•Noise cancellation for a superior voice experience in the noisiest environments</li> <li>•Detachable swivel boom minimizes costs.</li> <li>•Swivelling boom mutes microphone allowing uses to prevent voice pick applications from recognizing non-voice pick conversations.</li> <li>•User-replaceable pads and windscreens maximize comfort and hygiene.</li> <li>•Not compatible with MC9300 which doesn't include a headset jack. Use a Bluetooth headset (HS3100) instead.</li> </ul>	<ul style="list-style-type: none"> <li>For MC30XX series: Headset Adapter Cable (25-124387-02R)</li> <li>For MC31/MC32/MC33 series: Headset Adapter Cable (25-124411-02R)</li> </ul>
VR12 (3rd party) * <a href="http://www.blueparrott.com">http://www.blueparrott.com</a>		BlueParrott VR12 Wired Noise Cancelling Headset	<ul style="list-style-type: none"> <li>•Audio accuracy for voice picking and other speech recognition applications.</li> <li>•High quality durability stands up to all-day, every-day use.</li> <li>•Lightweight design is easy and comfortable to wear all day.</li> <li>•Compatible with most major wearable computers and devices used in voice-picking environments.</li> <li>•G type (GN Netcom) Quick Disconnect.</li> <li>•Convertible design gives choice of over-the-head and behind-the-neck wearing styles.</li> <li>•Not compatible with MC9300 which doesn't include a headset jack. Use a Bluetooth headset instead.</li> </ul>	<ul style="list-style-type: none"> <li>Headset Adapter Cable (25-124387-02R)</li> </ul>





RCH51		Rugged Cabled Headset	<ul style="list-style-type: none"> <li>Discontinued 12/2018, now use HS2100 series - PMB 2981</li> <li>Improved to withstand chemicals in certain hair gels</li> <li>Noise cancelling microphone filters ambient noise inches away</li> <li>Extremely rugged strain relief features ensure cable bend tolerance, even at -30C</li> <li>IP67 sealing throughout the headset protects sensitive components from moisture and dust</li> <li>High-strength plastics survive 6' drop at -30C &amp; 500 tumbles</li> <li>Weight: 4 oz.</li> <li>See RCH50/RCH51 Accessories Document for additional accessories.</li> <li>Not compatible with MC9300 which does not include a headset jack. Use a Bluetooth headset (HS3100) instead.</li> </ul>	Headset Adapter Cable (25-124387-02R)
RCH50		Rugged Cabled Headset	<ul style="list-style-type: none"> <li>Discontinued 10/2011, now use RCH51</li> <li>Noise cancelling microphone filters ambient noise inches away</li> <li>Extremely rugged strain relief features ensure cable bend tolerance, even at -30C</li> <li>IP67 sealing throughout the headset protects sensitive components from moisture and dust</li> <li>High-strength plastics survive 6' drop at -30C &amp; 500 tumbles</li> <li>Weight: 4 oz.</li> <li>See RCH50 Accessories Document for additional accessories.</li> <li>Not compatible with MC9300 which does not include a headset jack. Use a Bluetooth headset (HS3100) instead.</li> </ul>	Headset Adapter Cable (25-124387-01R)
50-11300-050R		Noise Cancelling Headset	<ul style="list-style-type: none"> <li>Discontinued 8/2011, now use RCH50</li> <li>Used to make phone calls or use voice directed applications.</li> <li>Not compatible with MC9300 which does not include a headset jack. Use a Bluetooth headset (HS3100) instead.</li> </ul>	
3PTY-VXI-VR12 (Zebra orderable SKU)  <a href="http://www.vxicorp.com">http://www.vxicorp.com</a>		BlueParrot VR12 Wired Noise Cancelling Headset  	<ul style="list-style-type: none"> <li>Discontinued 10/2018, now use HS2100 series - PMB 10005</li> <li>Audio accuracy for voice picking and other speech recognition applications.</li> <li>High quality durability stands up to all-day, every-day use.</li> <li>Lightweight design is easy and comfortable to wear all day.</li> <li>Compatible with most major wearable computers and devices used in voice-picking environments.</li> <li>G type (GN Netcom) Quick Disconnect.</li> <li>Convertible design gives choice of over-the-head and behind-the-neck wearing styles.</li> <li>Not compatible with MC9300 which does not include a headset jack. Use a Bluetooth headset (HS3100) instead.</li> </ul>	Headset Adapter Cable (25-124387-02R)



<p>See HS2100-HS3100 Accessories Document</p>		<p>HS3100 Rugged Bluetooth Headset</p>	<ul style="list-style-type: none"> <li>▶HD Voice, also known as Wide Band Audio, brings incredible audio clarity</li> <li>▶Built to handle the everyday inevitable drops</li> <li>▶Dustproof, sprayproof and waterproof</li> <li>▶Ready for the freezer and outdoor subzero temperatures</li> <li>▶Feather-light for extraordinary comfort</li> <li>▶Noise cancellation for a superior voice experience in the noisiest environments</li> <li>▶Swap batteries on the fly — without losing the Bluetooth connection</li> <li>▶Split-second tap-to-pair simplicity using NFC.</li> <li>▶Detachable swivel boom minimizes costs.</li> <li>▶Swivelling boom mutes microphone allowing uses to prevent voice pick applications from recognizing non-voice pick conversations.</li> <li>▶User-replaceable pads and windscreens maximize comfort and hygiene</li> <li>▶15 hours of battery power</li> <li>▶Compatible with MC9300 or MC92N0 (WEC7 or WEHH 6.5 units only). Not compatible with MC92N0 Android Jellybean units.</li> </ul>	<ul style="list-style-type: none"> <li>▶See HS2100/HS3100 Accessories Document for headset accessories</li> <li>▶May require Bluetooth Wideband Speech CAB file from support site to enable StoneStreet BT stack wideband (16 Khz) audio support.</li> </ul>
<p>various Bluetooth models B550-XT B350-XT C400-XT C300-XT  (3rd party) *  <a href="http://www.blueparrott.com">http://www.blueparrott.com</a></p>		<p>BlueParrott Bluetooth Headsets</p>	<ul style="list-style-type: none"> <li>▶Various Bluetooth models available with options that include: <ul style="list-style-type: none"> <li>- Blocking out 96% of background noise</li> <li>- Over 24 hours of talk time</li> <li>- NFC Tap to Pair capable</li> <li>- Bluetooth wireless range capable up to 300 ft.</li> <li>- Convertible wearing options: over the head, behind the neck.</li> </ul> </li> </ul> <p>See BlueParrot site for model specific options.</p>	
<p>3PTY-VXI-B350XT  (Zebra orderable SKU)  <a href="http://www.vxicorp.com">http://www.vxicorp.com</a></p>		<p>BlueParrott Bluetooth Headset for voice directed applications</p> 	<ul style="list-style-type: none"> <li>▶Discontinued 10/2018, now use HS3100 series - PMB 10005</li> <li>▶Used to enable Voice Directed Picking (VDP) or Speech Applications in warehouse environments when the use of a wireless headset is desired</li> <li>▶<u>Not</u> intended to support peer-to-peer communications (PTT) or VoIP calls.</li> <li>▶Provides 24 hours talk time.</li> <li>▶Works with StoneStreet Bluetooth stack. Will not function with Microsoft BT stack or voice applications that depend on the Microsoft BT stack.</li> <li>▶Allows the use of other BT devices (i.e. RS507 scanner or mobile printer)</li> <li>▶Compatible with MC9300 or MC92N0 (WEC7 or WEHH 6.5 units only). Not compatible with MC92N0 Android Jellybean units.</li> <li>▶Zebra Compatible certification for VDP application use with MC32.</li> </ul>	<ul style="list-style-type: none"> <li>▶May require Bluetooth Wideband Speech CAB file from support site to enable StoneStreet BT stack wideband (16 Khz) audio support.</li> </ul>

<p>3PTY-VXI-B250XTP (Zebra orderable SKU)</p> <p><a href="http://www.vxicorp.com">http://www.vxicorp.com</a></p>		<p>BlueParrott Bluetooth Headset for voice directed applications</p> 	<ul style="list-style-type: none"> <li>Discontinued 10/2018, now use HS3100 series - PMB 10005</li> <li>Used to enable Voice Directed Picking (VDP) or Speech Applications in warehouse environments when the use of a wireless headset is desired</li> <li>Not intended to support peer-to-peer communications (PTT) or VoIP calls.</li> <li>Provides 20 hours talk time.</li> <li>Works with StoneStreet Bluetooth stack. Will not function with Microsoft BT stack or voice applications that depend on the Microsoft BT stack.</li> <li>Allows the use of other BT devices (i.e. RS507 scanner or mobile printer)</li> <li>Compatible with MC9300 or MC92N0 (WEC7 or WEHH 6.5 units only). Not compatible with MC92N0 Android Jellybean units.</li> </ul>	<ul style="list-style-type: none"> <li>May require Bluetooth Wideband Speech CAB file from support site to enable StoneStreet BT stack wideband (16 Khz) audio support.</li> </ul>
<p>3PTY-VXI-EXPWAYII (Zebra orderable SKU)</p> <p><a href="http://www.vxicorp.com">http://www.vxicorp.com</a></p>		<p>BlueParrott Bluetooth Headset for voice directed applications</p> 	<ul style="list-style-type: none"> <li>Discontinued 10/2018, now use HS3100 series - PMB 10005</li> <li>Used to enable Voice Directed Picking (VDP) or Speech Applications in warehouse environments when the use of a wireless headset is desired</li> <li>Not intended to support peer-to-peer communications (PTT) or VoIP calls.</li> <li>Provides 8 hours talk time.</li> <li>Works with StoneStreet Bluetooth stack. Will not function with Microsoft BT stack or voice applications that depend on the Microsoft BT stack.</li> <li>Allows the use of other BT devices (i.e. RS507 scanner or mobile printer)</li> <li>Compatible with MC9300 or MC92N0 (WEC7 or WEHH 6.5 units only). Not compatible with MC92N0 Android Jellybean units.</li> <li>Zebra Compatible certification for VDP application use with MC92, VC70, WT41 and MC32.</li> </ul>	<ul style="list-style-type: none"> <li>May require Bluetooth Wideband Speech CAB file from support site to enable StoneStreet BT stack wideband (16 Khz) audio support.</li> </ul>
<p>APTT1 (3rd party) *</p> <p><a href="https://www.aina-wireless.com/">https://www.aina-wireless.com/</a></p>		<p>Aina Push-To-Talk (PTT) Bluetooth Voice Responder Remote Speaker/Mic (RSM)</p>	<ul style="list-style-type: none"> <li>Bluetooth speaker-microphone designed to work with different walkie talkie style Push-to-Talk applications, including Zebra PTT Pro (check with Zebra PTT Pro engineering team for current device/OS support).</li> <li>Includes clip for attaching device to clothing for lapel speaker/mic usage.</li> <li>Features several buttons which the application developers can assign to different functions.</li> <li>Users can remotely control functions such as push-to-talk, phone calls, channel switching and emergency alerts.</li> <li>Device is ruggedized, MIL-STD 810G and IP67.</li> <li>Long lasting battery designed for 24 hour approx battery life. Can be recharged via micro-USB port.</li> <li>Includes 3.5mm headset jack allowing headphones to be connected for keeping conversations more private.</li> <li>Can be easily paired to mobile computer using NFC tap-to-pair.</li> </ul>	

<p>H3-B-1 (3rd party) *</p> <p><a href="https://www.dellking.com">https://www.dellking.com</a></p>		<p>Wandfu H3 Push-To-Talk (PTT) Bluetooth Remote Speaker/Mic (RSM)</p>	<ul style="list-style-type: none"> <li>▶Bluetooth speaker-microphone designed to work with different walkie talkie style Push-to-Talk applications, including Zebra PTT Pro (check with Zebra PTT Pro engineering team for current device/OS support).</li> <li>▶Includes clip for attaching device to clothing for lapel speaker/mic usage.</li> <li>▶Includes 3.5mm headset jack allowing headphones to be connected for keeping conversations more private.</li> </ul>	
<p>BTR-155 (3rd party) *</p> <p>K551011 (Zebra orderable SKU) ▶Discontinued 3/2019, now order from Savox</p> <p><a href="https://www.savoxaccessories.com">https://www.savoxaccessories.com</a></p>		<p>Savox BTR-155 Bluetooth Remote Speaker/Mic (RSM)</p>	<ul style="list-style-type: none"> <li>▶Bluetooth speaker-microphone designed to work with different walkie talkie style Push-to-Talk applications, including Zebra PTT Pro (check with Zebra PTT Pro engineering team for current device/OS support).</li> <li>▶Includes clip for attaching device to clothing for lapel speaker/mic usage.</li> <li>▶Rugged wireless speaker microphone, IP55.</li> <li>▶Allows cable-free movement</li> <li>▶Familiar speaker microphone functions; PTT and volume buttons</li> <li>▶Includes 2.5mm headset jack allowing headphones to be connected for keeping conversations more private.</li> <li>▶LED status indication</li> <li>▶High speaker volume</li> <li>▶Includes: <ul style="list-style-type: none"> <li>- Savox RSM</li> <li>- Modular Wired earpiece</li> <li>- Wall Charger</li> <li>- USB Cable</li> <li>- Quick Start Guide</li> <li>- Carrying Strap</li> </ul> </li> </ul>	
<p>BTH-101 (3rd party) *</p> <p><a href="https://www.savoxaccessories.com">https://www.savoxaccessories.com</a></p>		<p>Savox Push-To-Talk (PTT) Bluetooth Headset</p>	<ul style="list-style-type: none"> <li>▶Bluetooth headset designed to work with different walkie talkie style Push-to-Talk applications, including Zebra PTT Pro (check with Zebra PTT Pro engineering team for current device/OS support).</li> <li>▶Also operates as standard Bluetooth headset for taking phone calls.</li> <li>▶Device is lightweight and ruggedized, IP55.</li> </ul>	
<p>21-69024-01R</p>		<p>Headset</p>	<ul style="list-style-type: none"> <li>▶Discontinued 5/2012</li> <li>▶Used to make phone calls.</li> <li>▶Not compatible with MC9300 which doesn't include a headset jack. Use a Bluetooth headset (HS3100) instead.</li> </ul>	

CBL-HS2100-QDC1-02		HS2100 Quick Disconnect Cable	<ul style="list-style-type: none"> <li>For use when connecting HS2100 to devices using standard Quick Disconnect jack.</li> <li>Cable length is approximately 33" (84 cm).</li> <li>Has improved quick disconnect connector and strain relief vs. CBL-HS2100-QDC1-01.</li> </ul>	
CBL-HS2100-QDC1-01		HS2100 Quick Disconnect Cable	<ul style="list-style-type: none"> <li>Discontinued 5/2019, now use CBL-HS2100-QDC1-02</li> <li>For use when connecting HS2100 to devices using standard Quick Disconnect jack.</li> </ul>	
25-124387-02R		RCH50/RCH51 Headset Adapter Cable	<ul style="list-style-type: none"> <li>Connects RCH50/RCH51 headset to devices with standard 3-pole 2.5mm barrel jack connector.</li> <li>Updated cable minimizes cross talk and intermittency issues.</li> <li>Not compatible with MC9300 which doesn't include a headset jack. Use a Bluetooth headset (HS3100) instead.</li> </ul>	
25-124387-01R		RCH50/RCH51 Headset Adapter Cable	<ul style="list-style-type: none"> <li>Discontinued 9/2013, now use 25-124387-02R</li> <li>Connects RCH50/RCH51 headset to devices with standard 3-pole 2.5mm barrel jack connector.</li> <li>Not compatible with MC9300 which doesn't include a headset jack. Use a Bluetooth headset (HS3100) instead.</li> </ul>	

**Power Cords/Power Supplies**

Part Number	Picture	Description	Notes	Required Items
CBL-DC-388A1-01		DC Power Cord	<ul style="list-style-type: none"> <li>Used along with Power Supply PWR-BGA12V50W0WW to power CRD9000-1001S, ADP9000, and MSR9000.</li> <li>Cable length is 1.8 meters</li> </ul>	
CBL-DC-395A1-01		DC Power Cord	Used along with Power Supply PWR-BGA12V50W0WW to power SAC9000 4-Slot Battery Charger	
PWR-BGA12V50W0WW		Power Supply	<ul style="list-style-type: none"> <li>Used to power CRD9000-1001S, ADP9000, and MSR9000.</li> <li>100-240 VAC, 12V, 4.16A, 50W</li> <li>Provides US DOE Level VI compliance for power efficiency.</li> <li>Replaces PWRS-14000-148R</li> </ul>	DC Line Cord (CBL-DC-388A1-01) and AC Line Cord (23844-00-00R)
KIT-PWR-12V50W		Power Supply Kit for Single Slot Cradle and Snap-Ons	<ul style="list-style-type: none"> <li>Used to power CRD9000-1001S, ADP9000, and MSR9000</li> <li>Includes Power Supply (PWR-BGA12V50W0WW) and DC Line Cord (CBL-DC-388A1-01)</li> </ul>	AC Line Cord (23844-00-00R)
KT-PWR-50W395A1-01		Power Supply Kit for 4-Slot Battery Charger	<ul style="list-style-type: none"> <li>Used to power SAC9000 Battery Charger</li> <li>Includes Power Supply (PWR-BGA12V50W0WW) and DC Line Cord (CBL-DC-395A1-01)</li> </ul>	AC Line Cord (23844-00-00R)



PWRS-14000-148R		Power Supply with integrated DC Cord	<ul style="list-style-type: none"> <li>Discontinued 1/2017, now use PWR-BGA12V50W0WW and CBL-DC-388A1-01 - see PMB 2923 and PMB 2851.</li> <li>Replaces KT-14000-148R</li> <li>Used to power CRD9000-1001S, ADP9000, and MSR9000</li> <li>100-240 VAC, 12VDC, 3.33A</li> <li>Energy Star Compliant</li> </ul>	23844-00-00R
50-14000-148R		Power Supply with integrated DC Cord	<ul style="list-style-type: none"> <li>Discontinued 12/2007 - replaced by KT-14000-148R</li> <li>Used to power CRD9000-1001S, ADP9000, and MSR9000</li> </ul>	23844-00-00R
KT-14000-148R		Power Supply with integrated DC Cord	<ul style="list-style-type: none"> <li>Replaces 50-14000-148R</li> <li>Used to power CRD9000-1001S, ADP9000, and MSR9000</li> <li>Discontinued 12/2010 - now use PWRS-14000-148R</li> </ul>	23844-00-00R
50-16002-011R		DC Power Cord	Used with Power Supply PWRS-14000-242R to power CRD9000-1001S, ADP9000, and MSR9000 when 50-14001-008R/50-14000-242R/PWRS-14000-242R power supply is used (this is not standard - use 50-14000-148R/KT-14000-148R/PWRS-14000-148R instead)	
25-72614-01R		DC Power Cord	Used with Power Supply PWRS-14000-242R to power SAC9000 Battery Charger	
PWRS-14000-242R		Power Supply	<ul style="list-style-type: none"> <li>Replaces 50-14000-242R</li> <li>Used to power SAC9000.</li> <li>Can also be used to power CRD9000-1001S, ADP9000, MSR9000 instead of 50-14000-148R/KT-14000-148R/PWRS-14000-148R (this is not standard)</li> <li>100-240VAC, 15VDC, 5A</li> <li>Energy Star Compliant</li> </ul>	25-72614-01R to power SAC9000
50-14001-008R		Power Supply	<ul style="list-style-type: none"> <li>Discontinued 12/2007 - replaced by 50-14000-242R</li> <li>Used to power SAC9000.</li> <li>Can also be used to power CRD9000-1001S, ADP9000, MSR9000 instead of 50-14000-148R/KT-14000-148R/PWRS-14000-148R (this is not standard)</li> </ul>	
50-14000-242R		Power Supply	<ul style="list-style-type: none"> <li>Replaces 50-14001-008R</li> <li>Used to power SAC9000.</li> <li>Can also be used to power CRD9000-1001S, ADP9000, MSR9000 instead of 50-14000-148R/KT-14000-148R/PWRS-14000-148R (this is not standard)</li> <li>Discontinued 12/2010 - now use PWRS-14000-242R</li> </ul>	25-72614-01R to power SAC9000
CBL-DC-382A1-01		DC Power Cord	Used with Power Supply PWR-BGA12V108W0WW to power Four Slot Cradles.	

50-16002-029R		DC Power Cord	<ul style="list-style-type: none"> <li>Used with Power Supply PWRS-14000-241R to power Four Slot Cradles and SAC9000 Battery Charger.</li> <li>Discontinued 2/2017, now use CBL-DC-382A1-01 - PMB 2851 and 2933</li> </ul>	
CBL-DC-523A1-01		2-Way DC Y Power Cord	<ul style="list-style-type: none"> <li>Used to power two 4-Slot Battery Chargers with one Power Supply (PWR-BGA12V108W0WW)</li> </ul>	
25-85993-01R		2-Way DC Y Power Cord	<ul style="list-style-type: none"> <li>Used to power two 4-Slot Battery Chargers with one Power Supply (PWRS-14000-241R)</li> <li>Discontinued 2/2017, now use CBL-DC-523A1-01 - PMB 2851 and 2933</li> </ul>	
PWR-BGA12V108W0WW		Power Supply	<ul style="list-style-type: none"> <li>Used to power Four Slot Cradles and SAC9000 Battery Charger</li> <li>100-240 VAC, 12V, 9A, 108W</li> <li>Provides US DOE Level VI compliance for power efficiency.</li> <li>Replaces PWRS-14000-241R</li> </ul>	CBL-DC-382A1-01 and 23844-00-00R
PWRS-14000-241R		Power Supply	<ul style="list-style-type: none"> <li>Replaces 50-14000-241R</li> <li>Used to power Four Slot Cradles and SAC9000 Battery Charger</li> <li>100-240VAC, 12VDC, 9A</li> <li>Energy Star Compliant</li> <li>Discontinued 2/2017, now use PWR-BGA12V108W0WW - PMB 2851 and 2933</li> </ul>	50-16002-029R and 23844-00-00R
50-14001-004R		Power Supply	<ul style="list-style-type: none"> <li>Discontinued 12/2007 - replaced by 50-14000-241R</li> <li>Used to power Four Slot Cradles and SAC9000 Battery Charger (can use 50-14001-008/50-14000-242R/PWRS-14000-242R for SAC9000 now)</li> </ul>	50-16002-029R and 23844-00-00R
50-14000-241R		Power Supply	<ul style="list-style-type: none"> <li>Replaces 50-14001-004R</li> <li>Used to power Four Slot Cradles and SAC9000 Battery Charger (can use 50-14001-008/50-14000-242R/PWRS-14000-242R for SAC9000 now)</li> <li>Discontinued 12/2010 - now use PWRS-14000-241R</li> </ul>	50-16002-029R and 23844-00-00R
23844-00-00R		AC Cable	Used with Power Supplies (50-14001-00x)	
PWR-WUA5V12W0US (US plug style) PWR-WUA5V12W0GB (UK plug style) PWR-WUA5V12W0EU (EU plug style) PWR-WUA5V12W0AU (Australia plug style) PWR-WUA5V12W0CN (China plug style) PWR-WUA5V12W0IN (India plug style) PWR-WUA5V12W0KR (Korea plug style) PWR-WUA5V12W0BR (Brazil plug style)		USB Power Supply for MC93	<ul style="list-style-type: none"> <li>Used with MC9300 USB Communication/Charging Cable Adapter (CBL-MC93-USBCHG-01) to provide a lower cost charging solution than using a Cradle.</li> <li>Provides higher current (2.5A) for faster charging</li> <li>100-240 VAC, 5 V, 2.5 A</li> </ul>	<ul style="list-style-type: none"> <li>MC9300 USB Communication/Charging Cable Adapter (CBL-MC93-USBCHG-01)</li> <li>USB-C Cable (CBL-TC2X-USBC-01) or (CBL-TC5X-USBC2A-01)</li> </ul>

<p>CHG-AUTO-USB1-01 CHG-AUTO-USB1-BR (for Brazil)</p>		<p>USB Cigarette Lighter Adapter for MC93</p>	<ul style="list-style-type: none"> <li>Used with MC9300 USB Communication/Charging Cable Adapter (CBL-MC93-USBCHG-01) to provide in-vehicle charging.</li> <li>Includes two USB A ports providing higher current (2.5A) for faster charging</li> </ul>	<ul style="list-style-type: none"> <li>MC9300 USB Communication/Charging Cable Adapter (CBL-MC93-USBCHG-01)</li> <li>USB-C Cable (CBL-TC2X-USBC-01) or (CBL-TC5X-USBC2A-01)</li> </ul>
<p>25-103872-02R</p>		<p>MC90xx Fork Lift Cradle Power Cable</p>	<ul style="list-style-type: none"> <li>Connects Fork Lift Cradle Power Converter to Fork Lift Cradle</li> <li>Has improved strain relief vs. 25-103872-01R</li> </ul>	
<p>25-103872-01R</p>		<p>MC90xx Fork Lift Cradle Power Cable</p>	<ul style="list-style-type: none"> <li>Discontinued 8/2015, now use 25-103872-02R</li> <li>Connects Fork Lift Cradle Power Converter to Fork Lift Cradle</li> </ul>	
<p>PWRS-14000-251R</p>		<p>MC90xx Fork Lift Cradle High Voltage Power Converter</p>	<ul style="list-style-type: none"> <li>Replaces 50-14000-251R, meets regulatory requirements for use in EU countries.</li> <li>Supports 36, 48, 60 nominal VDC fork lift vehicles.</li> <li>18-75VDC input, 12VDC output</li> <li>Energy Star Compliant</li> </ul>	
<p>50-14000-251R</p>		<p>MC90xx Fork Lift Cradle High Voltage Power Converter</p>	<ul style="list-style-type: none"> <li>Supports 36, 48, 60 nominal VDC fork lift vehicles.</li> <li>Discontinued 12/2010, now use PWRS-14000-251R</li> </ul>	
<p>PWRS-14000-252R</p>		<p>MC90xx Fork Lift Cradle Low Voltage Power Converter</p>	<ul style="list-style-type: none"> <li>Replaces 50-14000-252R, meets regulatory requirements for use in EU countries.</li> <li>Supports 12, 24 nominal VDC fork lift vehicles.</li> <li>9-30VDC input, 12VDC output</li> <li>Energy Star Compliant</li> </ul>	
<p>50-14000-252R</p>		<p>MC90xx Fork Lift Cradle Low Voltage Power Converter</p>	<ul style="list-style-type: none"> <li>Supports 12, 24 nominal VDC fork lift vehicles.</li> <li>Discontinued 12/2010, now use PWRS-14000-252R</li> </ul>	

KT-32665-02R		UBC Adapter Power Supply	<ul style="list-style-type: none"> <li>Used to power a single UBC Adapter (21-32665-xxR) when not using the UBC Charging Station.</li> <li>Includes Power Supply (50-14001-013R), DC Cable (50-16002-004R), and 4 rubber bumper feet to attach to bottom of UBC adapter.</li> <li>Discontinued May 2013</li> </ul>	23844-00-00R
KT-32665-03R		UBC Adapter Power Supply (International)	<ul style="list-style-type: none"> <li>Discontinued 11/2011</li> <li>Used to power a single UBC Adapter (21-32665-xxR) when not using the UBC Charging Station.</li> <li>Includes Power Supply (50-14001-006R), DC Cable (50-16002-004R), and 4 rubber bumper feet to attach to bottom of UBC adapter.</li> </ul>	23844-00-00R
VCA9002-12R		12V Car Charger	<ul style="list-style-type: none"> <li>Used to charge unit's battery in a vehicle. Plugs into cigarette lighter.</li> <li>Improvements made to the fuse holder retention to eliminate possibility of it opening with continuous insertion and removals.</li> <li>Complies with the UL60950 standard and has a CB test certificate</li> </ul>	ADP9000-100R
VCA9001-12R		12V Car Charger	<ul style="list-style-type: none"> <li>Used to charge unit's battery in a vehicle. Plugs into cigarette lighter.</li> <li>Improvements made to the fuse holder retention to eliminate possibility of it opening with continuous insertion and removals.</li> <li>Discontinued 8/31/2012 or while supplies last, now use VCA9002-12R</li> </ul>	ADP9000-100R
VCA9000-12R		12V Car Charger	<ul style="list-style-type: none"> <li>Used to charge unit's battery in a vehicle. Plugs into cigarette lighter.</li> <li>Discontinued 10/2010, now use VCA9001-12R</li> </ul>	ADP9000-100R
VCA9000-24R		24V Car Charger		ADP9000-100R

## Batteries

Part Number	Picture	Description	Notes	Required Items
BTRY-MC93-STN-01 (single) BTRY-MC93-STN-10 (10 pack) BTRY-MC93-STN-IN (for use in India)		MC9300 Spare Standard Battery with PowerPrecision Plus (7000 mAh - 25Wh) 	<ul style="list-style-type: none"> <li>Designed, manufactured &amp; tested to meet rigorous controls &amp; standards</li> <li>Premium-grade cells with higher capacity &amp; longer life cycle</li> <li>Designed to help prevent overcharging &amp; electrical shock</li> <li>Strong &amp; robust housing for optimal performance &amp; durability</li> <li>Information available:               <ul style="list-style-type: none"> <li>Advanced state of Charge (shows the remaining battery power based on two factors: present charge and present real-time usage patterns of the device).</li> <li>Advanced State of Health (highly accurate end-of-life prediction)</li> <li>Dynamic usage patterns are constantly calculated, factoring in criteria such as the applications that are in use and scanning frequency).</li> </ul> </li> <li>Only compatible with MC9300.</li> </ul>	







<p>BTRY-MC93-FRZ-01 (single)</p> <p>BTRY-MC93-FRZ-10 (10 pack)</p>		<p>MC9300 Spare Freezer Battery with PowerPrecision Plus (5000 mAh - 18Wh)</p> 	<ul style="list-style-type: none"> <li>•Designed, manufactured &amp; tested to meet rigorous controls &amp; standards</li> <li>•Premium-grade cells with higher capacity &amp; longer life cycle</li> <li>•Designed to help prevent overcharging &amp; electrical shock</li> <li>•Strong &amp; robust housing for optimal performance &amp; durability</li> <li>•Information available: <ul style="list-style-type: none"> <li>- Advanced state of Charge (shows the remaining battery power based on two factors: present charge and present real-time usage patterns of the device.</li> <li>- Advanced State of Health (highly accurate end-of-life prediction)</li> <li>- Dynamic usage patterns are constantly calculated, factoring in criteria such as the applications that are in use and scanning frequency).</li> </ul> </li> <li>•Lower battery capacity (5000 mAh) compared to standard battery (7000 mAh) is capable of providing more power at typical freezer temperature than the standard battery.</li> <li>•Only compatible with MC9300.</li> </ul>	
<p>BTRY-MC93-NI-01 (single)</p> <p>BTRY-MC93-NI-10 (10 pack)</p>		<p>MC9300 Spare Non-Incendive Battery with PowerPrecision Plus (7000 mAh - 25Wh)</p> 	<ul style="list-style-type: none"> <li>•Battery is designed to be used with MC9300 NI (Non-Incendive) devices.</li> <li>•Designed, manufactured &amp; tested to meet rigorous controls &amp; standards</li> <li>•Premium-grade cells with higher capacity &amp; longer life cycle</li> <li>•Designed to help prevent overcharging &amp; electrical shock</li> <li>•Strong &amp; robust housing for optimal performance &amp; durability</li> <li>•Information available: <ul style="list-style-type: none"> <li>- Advanced state of Charge (shows the remaining battery power based on two factors: present charge and present real-time usage patterns of the device.</li> <li>- Advanced State of Health (highly accurate end-of-life prediction)</li> <li>- Dynamic usage patterns are constantly calculated, factoring in criteria such as the applications that are in use and scanning frequency).</li> </ul> </li> <li>•Only compatible with MC9300.</li> </ul>	
<p>BTRY-MC9X-26MA-01 BTRY-MC9X-26ISK-01 (for India and South Korea)</p> <p>BTRY-MC9X-26MA-10 (10 pack)</p>		<p>MC90/MC91/MC92 Gun &amp; Brick Spare Battery with PowerPrecision (2600 mAh - 19Wh)</p> 	<ul style="list-style-type: none"> <li>•Works with any MC90/MC91/MC92 configuration.</li> <li>•Supports PowerPrecision battery management application</li> </ul>	
<p>KT-21-61261-01</p> <p>BTRY-MC90GKAB0E-10 (10 pack)</p> <p>BTRY-MC90GKAB0E-50 (50 pack)</p>		<p>MC90/MC91/MC92 Gun &amp; Brick Spare Battery (2200 mAh - 16 Wh)</p>	<ul style="list-style-type: none"> <li>•Discontinued 7/2016, now use BTRY-MC9X-26MA-01 - PMB 2828</li> <li>•Works with any MC90/MC91/MC92 configuration</li> </ul>	
<b>Replacement Keyboards for MC9300</b>				
Part Number	Picture	Description	Notes	Required Items

<p>KYPD-MC9329NMR-01 (single)</p> <p>KYPD-MC9329NMR-10 (pack of 10)</p>		<p>29-Key Numeric Primary keyboard for MC93</p>	<ul style="list-style-type: none"> <li>▶Freezer compatible</li> <li>▶Backlight compatible</li> <li>▶Indoor / Outdoor use</li> <li>▶Expected to be available 9/2019</li> </ul>	
<p>KYPD-MC9334FNR-01 (single)</p> <p>KYPD-MC9334FNR-10 (pack of 10)</p>		<p>34-Key keyboard for MC93</p>	<ul style="list-style-type: none"> <li>▶Freezer compatible</li> <li>▶Backlight compatible</li> <li>▶Indoor / Outdoor use</li> </ul>	
<p>KYPD-MC9343FN-01 (single)</p> <p>KYPD-MC9343FN-10 (pack of 10)</p>		<p>43-Key keyboard for MC93</p>	<ul style="list-style-type: none"> <li>▶Freezer compatible</li> <li>▶Backlight compatible</li> <li>▶Indoor / Outdoor use</li> </ul>	
<p>KYPD-MC9353ANR-01 (single)</p> <p>KYPD-MC9353ANR-10 (pack of 10)</p>		<p>53-Key Standard keyboard for MC93</p>	<ul style="list-style-type: none"> <li>▶Freezer compatible</li> <li>▶Backlight compatible</li> <li>▶Indoor / Outdoor use</li> </ul>	
<p>KYPD-MC9353VT-01 (single)</p> <p>KYPD-MC9353VT-10 (pack of 10)</p>		<p>53-Key VT keyboard for MC93</p>	<ul style="list-style-type: none"> <li>▶Freezer compatible</li> <li>▶Backlight compatible</li> <li>▶Indoor / Outdoor use</li> </ul>	

<p>KYPD-MC93535250-01 (single)</p> <p>KYPD-MC93535250-10 (pack of 10)</p>		<p>53-Key 5250 keyboard for MC93</p>	<ul style="list-style-type: none"> <li>▶Freezer compatible</li> <li>▶Backlight compatible</li> <li>▶Indoor / Outdoor use</li> </ul>	
<p>KYPD-MC9358ANR-01 (single)</p> <p>KYPD-MC9358ANR-10 (pack of 10)</p>		<p>58-Key Alpha-Numeric keyboard for MC93</p>	<ul style="list-style-type: none"> <li>▶Freezer compatible</li> <li>▶Backlight compatible</li> <li>▶Indoor / Outdoor use</li> <li>▶Expected to be available 9/2019</li> </ul>	

**Replacement Keyboards for MC90/MC91/MC92 (NOTE: MC906x and MC909x/MC919x/MC92N0 keyboards are not interchangeable)**

MC909X/MC919X/MC92N0 Part Number	MC906X Part Number	Picture	Description	Notes
<p>KYPD-MC9XMR000-01R (internal P/N 21-79678-01)</p>	<p>KYPD-MC90MR000-01 ▶Discontinued July 2010</p>		<p>28-Key keyboard for MC90/MC91/MC92 Gun &amp; Brick</p>	
<p>KYPD-MC9XMX000-01R (internal P/N 21-87916-01) ▶Discontinued May 2013</p>	<p>N/A</p>		<p>33-Key keyboard for MC9x Gun &amp; Brick</p>	<p>Developed for DSD market</p>
<p>KYPD-MC9XMT000-01R (internal P/N 21-79677-01)</p>	<p>KYPD-MC90MT000-01 ▶Discontinued 12/2015 - PMB 2723</p>		<p>43-Key keyboard for MC90/MC91/MC92 Gun &amp; Brick</p>	

<p>KYPD-MC9XMS000-01R (internal P/N 21-79512-01)</p>	<p>KYPD-MC90MS000-01 ▶Discontinued 2/2019 - see PMB 10057</p>		<p>53-Key Standard keyboard for MC90/MC91/MC92 Gun &amp; Brick</p>	
<p>KYPD-MC9XMS000-11R (internal P/N 21-79512-09)</p>	<p>KYPD-MC90MS000-11</p>		<p>53-Key Standard keyboard for MC90/MC91/MC92 Gun &amp; Brick (with high visibility white alpha keys)</p>	<p>The lettering on the white keys don't wash out in low lighting conditions like the standard gray keys do.</p>
<p>KYPD-MC9XMU000-01R (internal P/N 21-79512-02)</p>	<p>KYPD-MC90MU000-01 ▶Discontinued 2/2019 - see PMB 10057</p>		<p>53-Key VT keyboard for MC90/MC91/MC92 Gun &amp; Brick</p>	
<p>KYPD-MC9XMV000-01R (internal P/N 21-79512-04)</p>	<p>KYPD-MC90MV000-01 ▶Discontinued 12/2013</p>		<p>53-Key 3270 keyboard for MC90/MC91/MC92 Gun &amp; Brick</p>	
<p>KYPD-MC9XMW000-01R (internal P/N 21-79512-03)</p>	<p>KYPD-MC90MW000-01 ▶Discontinued 2/2019 - see PMB 10057</p>		<p>53-Key 5250 keyboard for MC90/MC91/MC92 Gun &amp; Brick</p>	

N/A	KYPD-MC90KD000-01		20 Key Mechanical Keyboard for MC9x Gun & Brick	
-----	-------------------	---	--	--