



Digital Projector

# User Manual

Portable Entertainment Series | GS2

V 2.01

# Copyright and disclaimer

## Copyright

Copyright © 2020 by BenQ Corporation. All rights reserved. No part of this publication may be reproduced, transmitted, transcribed, stored in a retrieval system or translated into any language or computer language, in any form or by any means, electronic, mechanical, magnetic, optical, chemical, manual or otherwise, without the prior written permission of BenQ Corporation.

All other logos, products, or company names mentioned in this manual may be the registered trademarks or copyrights of their respective companies, and are used for informational purposes only.

Android™ is a trademark of Google LLC.

The Bluetooth® word mark and logos are registered trademarks owned by Bluetooth SIG, Inc. and any use of such marks by BenQ Corporation is under license.

iOS is a trademark or registered trademark of Cisco in the U.S. and other countries and is used under license.

macOS® is a trademark of Apple Inc., registered in the U.S. and other countries.

USB-C™ is a trademark of the USB Implementers Forum.

## Disclaimer

BenQ Corporation makes no representations or warranties, either expressed or implied, with respect to the contents hereof and specifically disclaims any warranties, merchantability or fitness for any particular purpose. Further, BenQ Corporation reserves the right to revise this publication and to make changes from time to time in the contents hereof without obligation of BenQ Corporation to notify any person of such revision or changes. This user manual aims to provide the most updated and accurate information to customers, and thus all contents may be modified from time to time without prior notice. Please visit <http://www.benq.com> for the latest version of this manual.

## Warranty

BenQ warrants this product against any defects in material and workmanship, under normal usage and storage.

Proof of purchase date will be required with any warranty claim. In the event this product is found to be defective within the warranty period, BenQ's only obligation and your exclusive remedy shall be replacement of any defective parts (labor included). To obtain warranty service, immediately notify the dealer from which you purchased the product of any defects.

Important: The above warranty shall be void if the customer fails to operate the product in accordance with BenQ's written instructions, especially the ambient humidity must be in-between 10% and 90%, temperature in-between 0°C and 40°C, altitude lower than 2000 meters, and avoiding to operate the projector in a dusty environment. This warranty gives you specific legal rights, and you may have other rights which vary from country to country.

For other information, please visit [www.BenQ.com](http://www.BenQ.com).

## Statement regarding hyperlinks and third-party websites

BenQ is not responsible for the content of the websites or of similar resources, which are maintained and controlled by third parties, that may be linked from this product. Providing links to those websites or to similar resources does not mean that BenQ makes any warranty or representation to their content by expression or by implication.

Any third party content or service preinstalled in this product is provided "as is". BenQ does not, by expression or by implication, make any warrant to the content or to the services provided by third parties. BenQ does not warrant or guarantee that the content or services provided by third parties are accurate, effective, most up-to-date, legal, or complete. Under no circumstances shall BenQ be liable for the content or services provided by third parties including their negligence.

Services provided by third parties may be terminated temporarily or permanently. BenQ does not warrant or guarantee that any content or services provided by third parties are in good condition at any time, and is not liable for the termination of the said content and services.

In addition, BenQ is not involved in any transactions you conduct in the websites or similar resources maintained by third parties.

You should contact the content or service providers for any questions, concerns, or disputes.

## Table of contents

Copyright and disclaimer .....	2
Copyright .....	2
Disclaimer .....	2
Warranty .....	2
Statement regarding hyperlinks and third-party websites .....	3
Package contents .....	11
Standard accessories .....	11
Introduction .....	13
Projector features .....	13
Projector exterior view .....	15
Front, top, and left side view .....	15
Rear and bottom side view .....	16
Controls and functions .....	17
Control panel .....	17
Ports .....	18
LED Indicators .....	19
Remote control .....	21
Activating the remote control battery .....	22
Replacing the remote control battery .....	23
Remote control effective range .....	24
<b>BenQ Smart Control</b> (remote control app) .....	24
Installing the <b>BenQ Smart Control</b> app on your smartphone .....	24

Using the <b>BenQ Smart Control</b> app.....	26
Installation .....	29
Choosing a location .....	29
Obtaining a preferred projected image size .....	31
Projection dimensions .....	31
Installing the projector on a tripod (purchased separately) .....	33
Operations .....	34
Installing the wireless dongle .....	34
Charging the battery.....	36
Starting up the projector .....	37
Shutting down the projector .....	42
Adjusting the projected image .....	43
Adjusting the projection angle.....	43
Fine-tuning the image clarity .....	44
Correcting keystone.....	45
<b>BenQ Launcher</b> .....	46
The <b>BenQ Launcher</b> home screen.....	46
Navigating the <b>BenQ Launcher</b> home screen.....	47
Using the source menu.....	48
Using the app shortcuts .....	49
Using the <b>BenQ Launcher Settings</b> menus.....	50
Inputting text.....	50
Connections .....	52
Wireless Connections .....	54
Connecting the projector to a wireless network.....	54

Wireless Projection for iOS & macOS®.....	57
Wireless Projection for Android™ .....	59
Wireless Projection for PC .....	61
wireless Hotspot .....	63
Wired Connections.....	67
Connecting a device with HDMI or USB-C™ with DisplayPort.....	67
Connecting a flash drive .....	70
Media Player .....	71
Bluetooth Connections .....	79
Pairing/Connecting to a Bluetooth speaker or headphones .....	79
Using the Projector as a Bluetooth speaker .....	82
Navigating the <b>Settings</b> menu .....	84
About the <b>Settings</b> menu.....	84
Using the <b>Settings</b> menu .....	85
<b>Network</b> .....	86
<b>Sounds</b> .....	87
<b>Bluetooth</b> .....	88
<b>Bluetooth Speaker Mode</b> .....	89
<b>All Apps</b> .....	90
<b>Hotspot</b> .....	91
<b>About</b> .....	92
<b>Picture</b> .....	93
<b>Wall Color</b> .....	96
<b>Auto Focus</b> .....	97
<b>Keystone</b> .....	98
<b>Screen Settings</b> .....	99
<b>Date &amp; Time</b> .....	101
<b>Language</b> .....	102
<b>Keyboard</b> .....	103
<b>Parental Control</b> .....	104

<b>Installation</b> .....	106
<b>Battery</b> .....	108
Other settings menu .....	109
<b>System Boots</b> .....	109
<b>Recent Apps</b> .....	110
<b>BenQ Smart Control</b> .....	111
<b>System Update</b> .....	112
Maintenance .....	114
Care of the projector .....	114
Cleaning the lens.....	114
Storing the projector .....	114
Transporting the projector .....	115
Extending LED life .....	115
Troubleshooting .....	117
Specifications .....	121
Projector specifications .....	121
Dimensions.....	125
Timing chart.....	126
Supported file formats.....	128

# Important safety instructions

Your projector is designed and tested to meet the latest standards for safety of information technology equipment. However, to ensure safe use of this product, it is important that you follow the instructions mentioned in this manual and marked on the product.

1. Please read this user manual before you operate your projector.  
Keep this manual in a safe place for future reference.

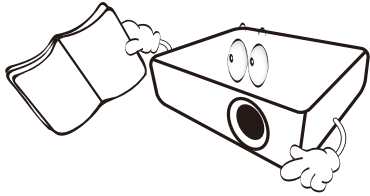

2. Always place the projector on a level, horizontal surface during operation.
  - Do not place the projector on an unstable cart, stand, or table as it may fall and be damaged.
  - Do not place inflammables near the projector.
  - Do not use if tilted at an angle of more than 10 degrees left to right, nor at angle of more than 15 degrees front to back.

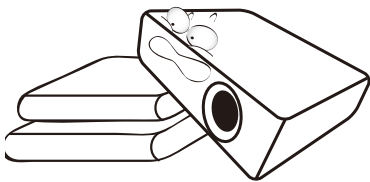

3. Do not store the projector on end vertically. Doing so may cause the projector to fall over, causing injury or resulting in damage.

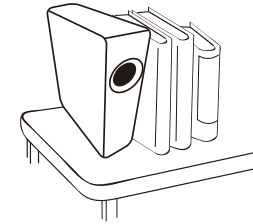

4. Do not place the projector in any of the following environments:
  - Space that is poorly ventilated or confined. Allow at least 50 cm clearance from walls and free flow of air around the projector.
  - Locations where temperatures may become excessively high, such as the inside of a car with all windows closed.
  - Locations where excessive humidity, dust, or cigarette smoke may contaminate optical components, shorten the projector's lifespan and darken the screen.

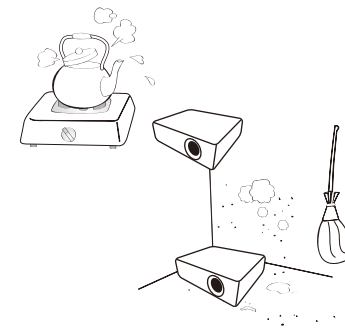

- Locations near fire alarms.
- Locations with an ambient temperature above 40°C/104°F.



- Locations where the altitudes are higher than 2000 m (6562 feet).

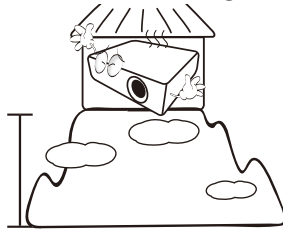

- Do not block the vents holes while the projector is on (even in power-saving mode).
  - Do not cover the projector with any item.
  - Do not place the projector on a blanket, bedding or any other soft surface.

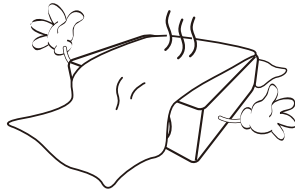

- In areas where the mains power supply voltage may fluctuate by  $\pm 10$  volts, it is recommended that you connect the projector through a power stabilizer, surge protector or uninterruptible power supply (UPS) as appropriate to your situation.

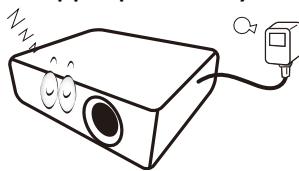

- Do not step on the projector or place any objects upon it.

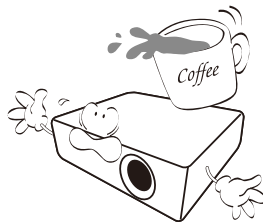

- Do not place liquids near or on the projector. Liquids spilled into the projector will void your warranty. If the projector does become wet, disconnect it from the power point and call BenQ to have the projector repaired.

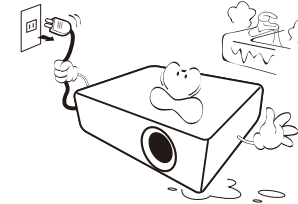

- Do not look straight into the projector lens during operation. It may harm your sight.

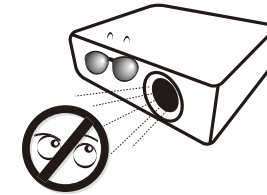

- Do not operate the projector lamp beyond the rated lamp life. Excessive operation of lamps beyond the rated life could cause a lamp to break on rare occasions.

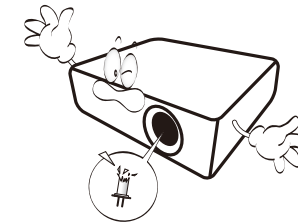

- The lamp becomes extremely hot during operation. Allow the projector to cool for approximately 45 minutes prior to removing the lamp assembly for replacement.

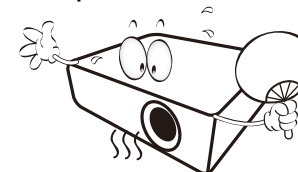

12. This projector is capable of displaying inverted images for ceiling installation.

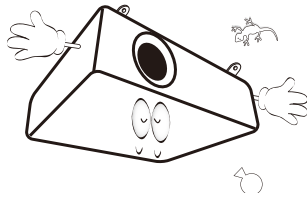

13. Do not attempt to disassemble this projector. There are dangerous high voltages inside which may cause death if you should come into contact with live parts.

Under no circumstances should you ever undo or remove any other covers. Refer servicing only to suitably qualified professional service personnel.

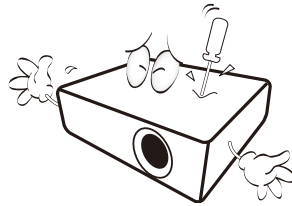

Please keep the original packing for possible future shipment. If you need to pack your projector after use, adjust the projection lens to an appropriate position, put the lens cushion around the lens, and fit the lens cushion and projector cushion together to prevent damage during transportation.

14. When you think service or repair is required, take the projector only to a suitably qualified technician.

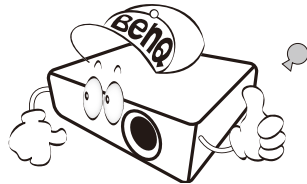

## Moisture condensation

Never operate the projector immediately after moving it from a cold location to a hot location. When the projector is exposed to such a change in temperature, moisture may condense on the crucial internal parts. To prevent the projector from possible damage, do not use the projector for at least 2 hours when there is a sudden change in temperature.

## Avoid volatile liquids

Do not use volatile liquids, such as insecticide or certain types of cleaner, near the projector. Do not have rubber or plastic products touching the projector for a long time. They will leave marks on the finish. If cleaning with a chemically treated cloth, be sure to follow the cleaning product's safety instructions.

## Disposal

This product contains the following materials which are harmful to human bodies and environment.

- Lead, which is contained in solder.
- Mercury, which is used in the lamp.

To dispose of the product or used lamps, consult your local environment authorities for regulations.



The illustrations and the images shown in this document are for your reference. The actual content may vary by the product supplied for your region.

# Package contents

Carefully unpack and verify that you have the items below. Some of the items may not be available depending on your region of purchase. Please check with your place of purchase.

## Standard accessories

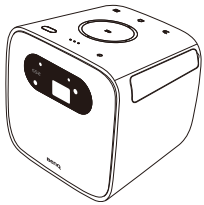

**GS2 Projector**



**Wireless Dongle (WDR02U)**



**Remote Control  
(with One CR2032 Battery)**

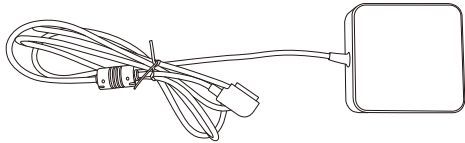

**Adapter**

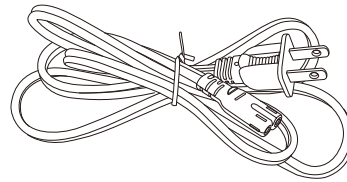

**Power Cord**

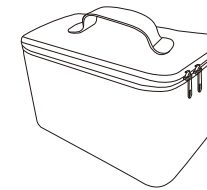

**Carry Bag**

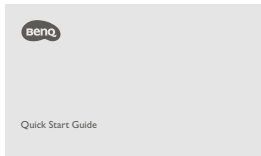

**Quick Start Guide**



**Regulatory Statement**

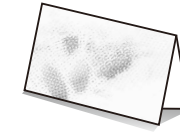

**Warranty Card**

- 
-  Lamp life results will vary depending on environmental conditions and usage. Actual product's features and specifications are subject to change without notice.
  - Some of the accessories may vary from region to region.
  - The warranty card is only supplied in some specific regions. Please consult your dealer for detailed information.
  - For AC/DC adapter, the socket-outlet shall be installed near the equipment and shall be easily accessible.
  - Use original accessories to ensure compatibility.
  - Power cord plug type may change based on regional requirements.
-

# Introduction

## Projector features

- **Instant Wireless Projection**

Release your hands and eyes to enjoy binge-watching on a big screen. If you have access to an internet connection, you can cast the screen from a mobile device through GS2 instantly. With GS2, you can just sit back, relax and enjoy some well-earned downtime.

- **Bluetooth® Speaker Mode**

Entertaining friends and family in style is easy with GS2. With Bluetooth 4.0 intelligent connection, you can set GS2 as a speaker, and play music from a mobile device through it. Bluetooth 4.0 lets you waste less battery power because, unless critical data is being shared, the connection is solid and secure. You can connect to your devices without draining the GS2 battery.

- **Designed with Protection from the Outdoors**

GS2 is certified with IPX2 standard protection against drizzle, water spillage, and dust from the air. Also, it has soft rubber surface designed to withstand 1-meter drop to the ground.

- **Care for Children's Eyes**

While GS2's LED reflection light brings children colorful and low-blue-light big screen gratification, its LumiExpert™ technology spontaneously adjusts the projection light output levels to create the most comfortable viewing experience in different environments. Moreover, its auto light shut off sensor automatically turns off the LED light when detecting objects within 30 centimeters in front of the projector so as to prevent the LED light from projecting into eyes upon accidental approaches and staring.

- **Magnetic DC-in Cable Connection**

GS2 secures the DC-in cable to the projector by magnets. Indoors or outdoors, the magnetic DC-in cable connection design prevents the users and projectors from tripping or stumbling over the cable and falling.

- **Parental Control**

GS2 features settings that help parents protect their children including a Parental Timer that prevents children from excessive use, and Wireless Projection security features which stops them from accessing inappropriate online contents.

- **Media Playback from USB Type C™ DisplayPort**

GS2 has a USB-C™ DisplayPort that supports both power and data transmission. It also allows you to project the screens of smart phones, tablets, and laptops that support the USB Type-C™ DisplayPort interface. Once a USB Type-C™ device is connected to GS2 via a USB-C™ Gen 3.1 cable, you can enjoy video on a big screen while charging your devices at the same time.

- **Portable Media Player**

GS2 supports a maximum of 3-hour projection in battery mode, and two powerful 2-W chamber speakers. You can take it everywhere to share enjoyment without the hassle of power adapters and various cables. It can also play as a Bluetooth speaker for you to enjoy your favorite music anytime.

# Projector exterior view

## Front, top, and left side view

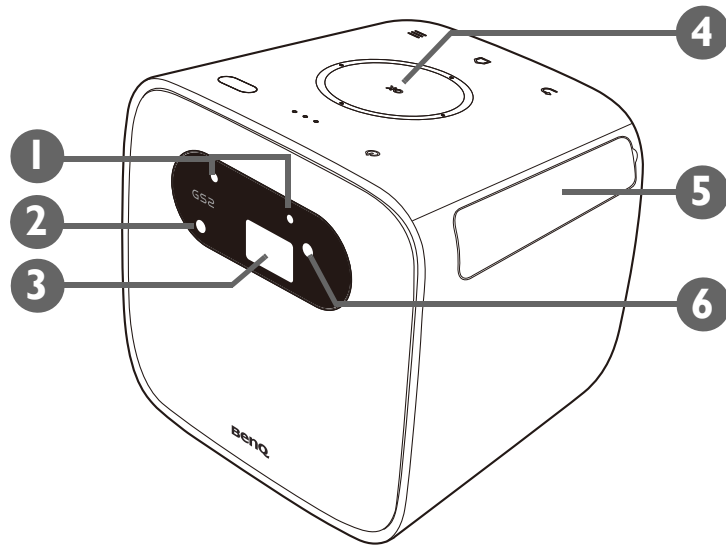

### 1. Auto light shut off sensors

Automatically turns off the LED light source when an object is detected within a distance of 30 centimeters (11.8 inches) in front of the projector for more than one second.

### 2. Auto focus camera

### 3. Projection lens

### 4. Control panel (See [Control panel on page 17](#) for details.)

### 5. IO cover (See [Ports on page 18](#) for details.)

Flip open from the recess on the right side to access the input/output ports.

### 6. Front IR sensor

## Rear and bottom side view

See [Connections on page 52](#) for connection details.

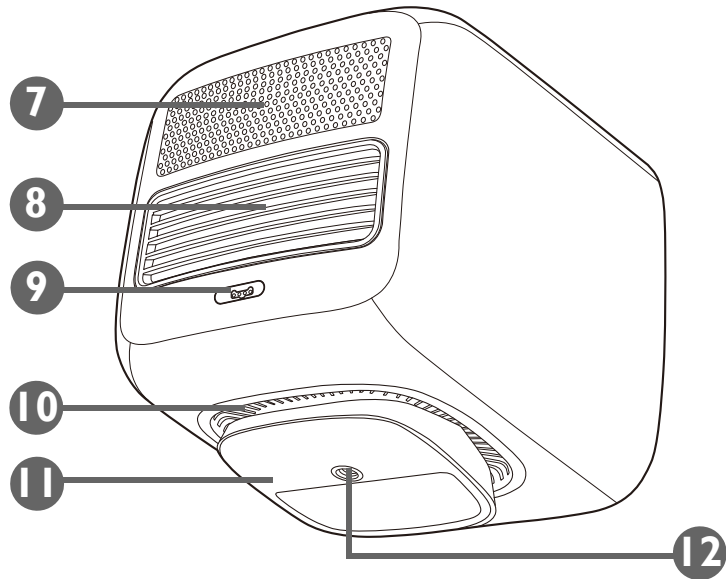

**7. Speaker**

**8. Rear vent**

**9. Power adapter port**



Please only use the supplied power adapter to avoid possible dangers such as electric shock and fire.

**10. Bottom vent**

**11. Adjustable stand**

**12. Tripod screw hole**

Used to attach a tripod plate to mount the projector onto a tripod. See [Installing the projector on a tripod \(purchased separately\) on page 33](#) for details.



# Controls and functions

## Control panel

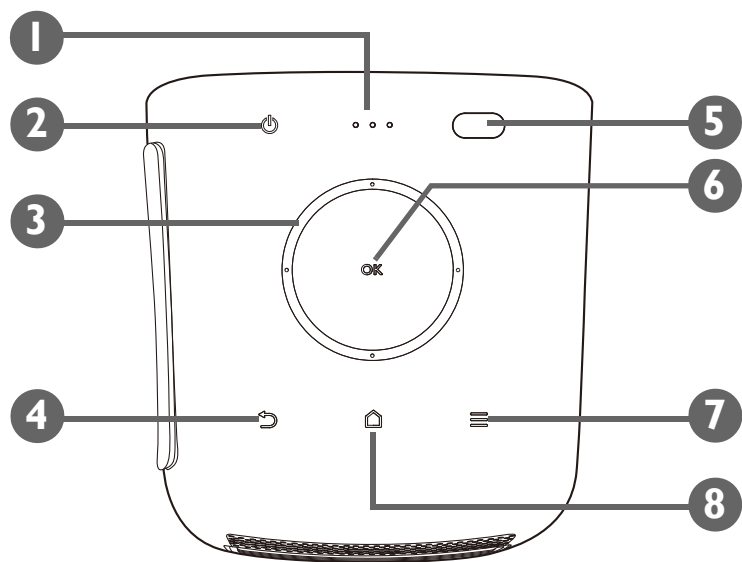

1. **LED indicators** (See [LED Indicators on page 19](#) for more details.)

2. **Power button**

Turns the projector on and off. See [Starting up the projector on page 37](#) for more details.

3. **Direction buttons (left, right, up, down)**

Used to select the desired menu items and to make adjustments.

4. **Back button**

Used to return to the previous layers.

5. **Ambient light sensor and rear IR sensor**

6. **OK button**

Used to confirm the selection on the **BenQ Launcher** menu.

7. **Menu button**

Launches the **BenQ Launcher** settings menu.

8. **Home button**

Press this key to enter the **BenQ Launcher** home menu.

# Ports

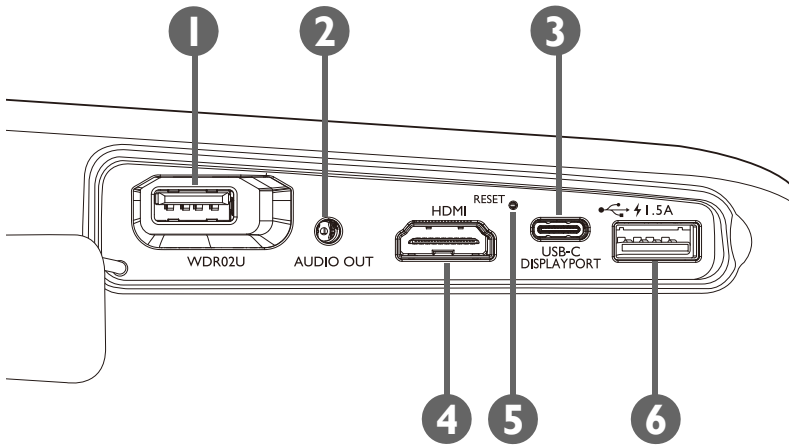

## 1. Wireless dongle port

Insert the BenQ WDR02U USB wireless dongle to enable wireless and Bluetooth connections. See [Installing the wireless dongle on page 34](#) for details.



The projector only supports wireless and/or Bluetooth connections when the wireless dongle is installed into this slot.

## 2. 3.5" audio output jack

Used to connect headphones, speakers, and other equipment to broadcast audio.

## 3. USB-C™ port

Used to connect devices with DisplayPort functionality to project video from the device or flash drives to project/broadcast media stored on the device.

## 4. HDMI 1.4a port

Used to connect video sources that support the HDMI interface.

## 5. Factory reset button

Insert a fine-tipped instrument to force shut down the projector.

## 6. USB 2.0 port

Used to connect a USB-A storage device to project/broadcast media stored on the device. You may also connect a wireless keyboard/mouse via this USB port.

# LED Indicators

There are one red/green LED (LED 1) and two green LEDs (LED 2 and LED 3) on the top of the projector.

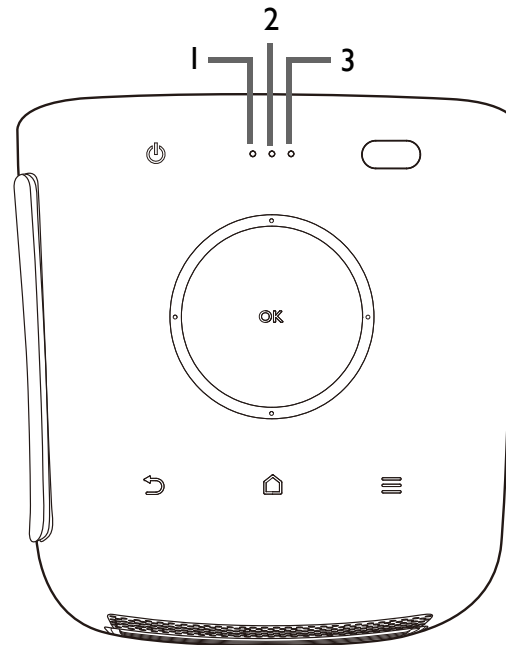

Refer to the table below for definitions of various LED behaviors.

Scenario	Status	LED 1		LED 2		LED 3	
		LED Behavior	Schema	LED Behavior	Schema	LED Behavior	Schema
Charging with Adapter	Battery charging in progress	Green - breathing		Green - breathing		Green - breathing	
	Battery charging complete	Green - solid		Green - solid		Green - solid	

Scenario	Status	LED 1		LED 2		LED 3	
		LED Behavior	Schema	LED Behavior	Schema	LED Behavior	Schema
Battery Mode	Battery capacity < 5%	N/A		N/A		N/A	
	Battery capacity < 16%	Red - solid		N/A		N/A	
	Battery capacity = 16 - 33%	Green - solid		N/A		N/A	
	Battery capacity = 33 - 66%	Green - solid		Green - solid		N/A	
	Battery capacity = 66 - 100%	Green - solid		Green - solid		Green - solid	
Bluetooth Speaker Mode	Ready to pair / Pairing	Green - flashing		N/A		Green - flashing	
	Pairing successful	Depends on power status					
System Update	System update in progress	Green - flashing		Green- flashing		Green- flashing	
	System update has failed	Red - flashing		N/A		N/A	
Error*	LED error	Red - flashing		Green- flashing		N/A	
	Fan error	Red - flashing		Green - flashing		Green- flashing	
	Optical engine temperature error	Red - solid		Green- flashing		N/A	
	Battery temperature error	Red - solid		Green- flashing		Green- flashing	
	Driver board error	Red - solid		N/A		Green- flashing	

\*Restart the projector if there are any errors.

# Remote control

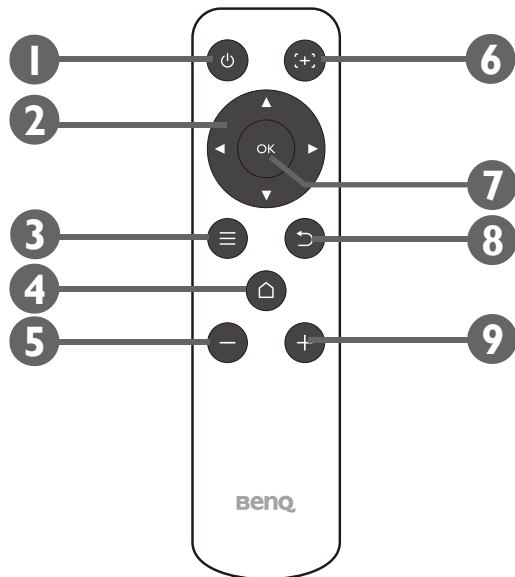

## 1. Power

Turns the projector off and on after initial startup.



After initially starting up the projector using the keypad button, the remote control power button can be used to turn the projector off or on for subsequent power ups.

See [Starting up the projector on page 37](#) for more details.

## 2. **Arrow keys (◀Left, ▶Right, ▲Up, ▼Down)**

Used as directional arrows to select the desired menu items and to make adjustments.

## 3. Menu

Launches the **BenQ Launcher** settings menu.

## 4. Home

Press this key to enter the **BenQ Launcher** home menu.



This key is only active when the projector is under **BenQ Launcher** mode.

## 5. **- Volume Down**

Decreases the projector volume.

## 6. Focus/Mouse Cursor

Short press this key to start auto focus; long press to enable the mouse cursor.

## 7. **OK**

Used to confirm the selection on the **BenQ Launcher** menu.

## 8. Back

Used to return to the previous menu.

## 9. **+ Volume Up**

Increases the projector volume.

## Activating the remote control battery

Before you can begin to use the remote control, you must first remove the clear plastic battery sticker between the battery and the contact on the remote control.

1. Use a flat-tipped instrument to rotate the battery cover counter-clockwise to the unlocked position.

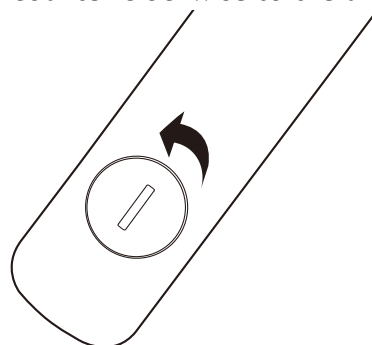

2. Remove the battery cover from the remote control.
3. Pull and remove the plastic battery sticker.

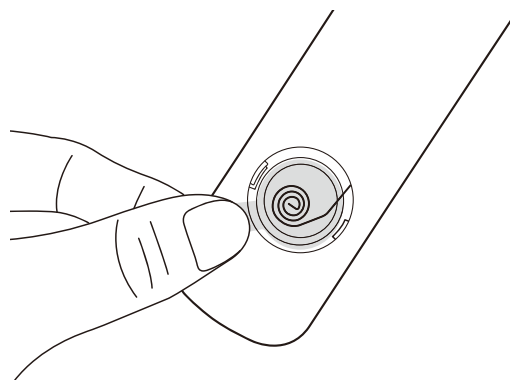

4. Place the battery cover back onto the remote control and rotate it clockwise to the locked position.

---

 Avoid leaving the remote control and battery in an excessive heat or humid environment like the kitchen, bathroom, sauna, sunroom or in a closed car.

---

## Replacing the remote control battery

1. Use a flat-tipped instrument to rotate the battery cover counter-clockwise to the unlocked position.

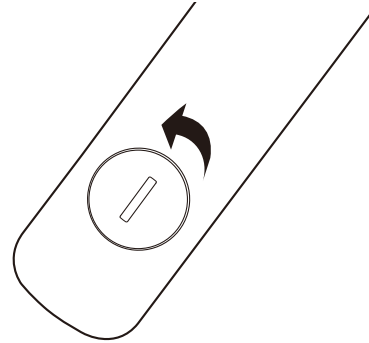

2. Remove the battery cover from the remote control.
3. Carefully dislodge the used battery from underneath the retention coil and slide it out from the remote control.

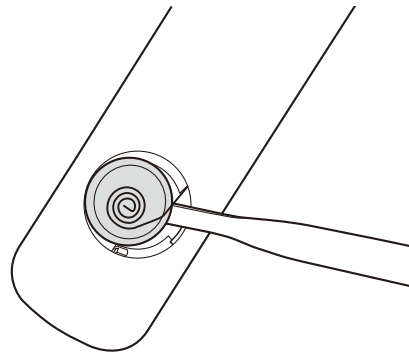

4. Slide the new battery into its position underneath the retention coil.
5. Place the battery cover back onto the remote control and rotate it clockwise to the locked position.



- Avoid leaving the remote control and battery in an excessive heat or humid environment like the kitchen, bathroom, sauna, sunroom or in a closed car.
- Replace only with the same or equivalent type recommended by the battery manufacturer.
- Dispose of the used batteries according to the manufacturer's instructions and local environment regulations for your region.
- Never throw the battery into a fire. There may be danger of an explosion.

## Remote control effective range

The projector has two IR remote control sensors. One is located at the front and the other at the top of the projector, both with a range of 8 meters (~26 feet) at an angle of 30-degrees (left and right) and 20-degrees (up and down). The remote control can be used either by pointing it directly at the IR sensors at the front or top of the projector or by reflecting the IR signal off of a wall.

Make sure that there are no obstacles between the remote control and the IR sensor on the projector.

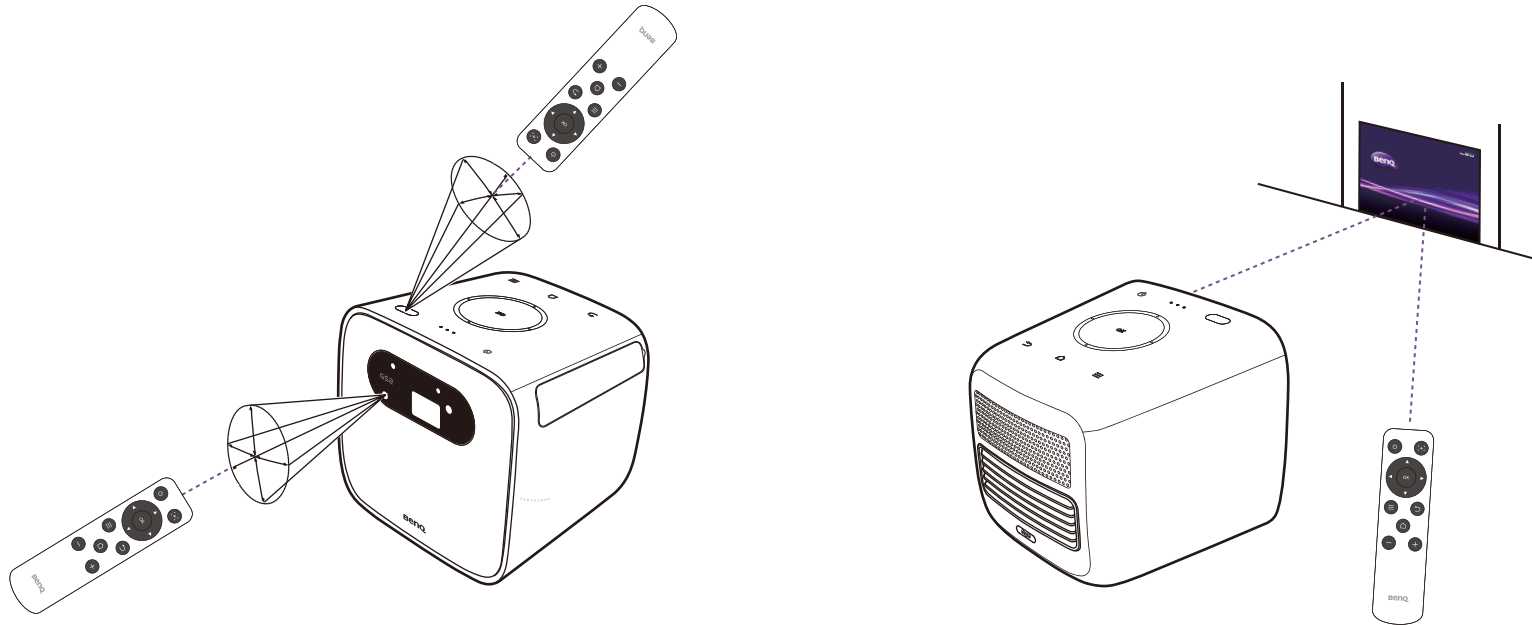

## BenQ Smart Control (remote control app)

The settings menu also features a link to install the **BenQ Smart Control** app, which lets you transform your smartphone into a remote control to control the projector via buttons and/or touch gestures.

## Installing the BenQ Smart Control app on your smartphone

To install the **BenQ Smart Control** app on your smartphone:

1. Make sure your smartphone is connected to the Internet.



2. Select **BenQ Smart Control** in the **Settings** menu of the **BenQ Launcher** home screen and then press **OK**.

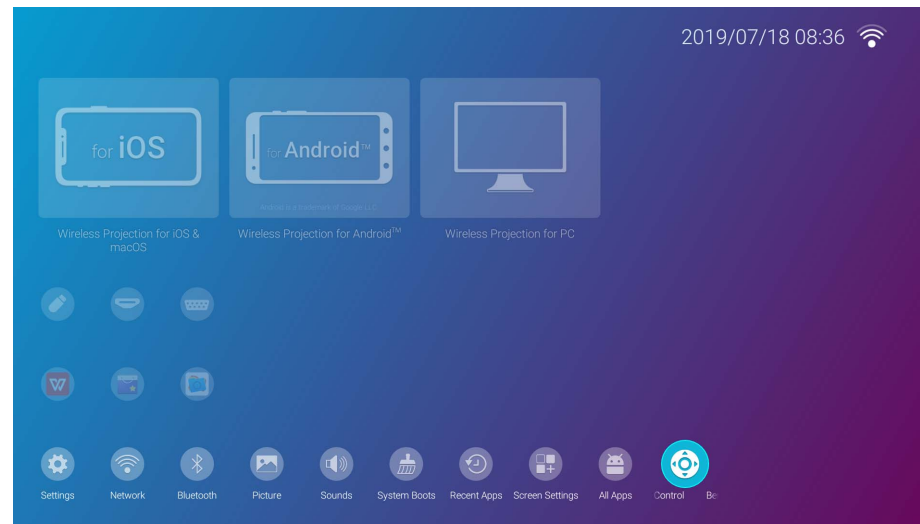

3. Scan the QR code shown on the projector with your smartphone, this will open a download link on your smartphone.

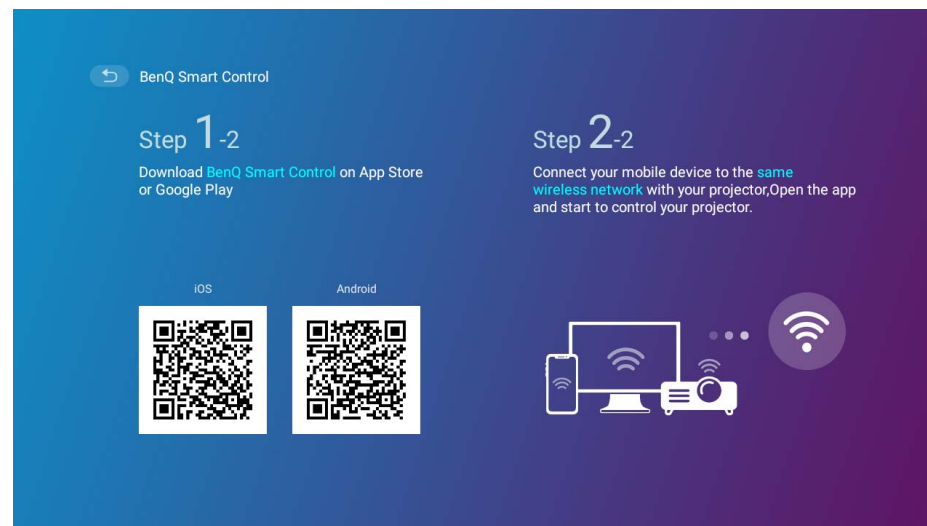

4. Download and install the **BenQ Smart Control** on to your smartphone.

---

 For some smartphones you may first need to allow your smartphones to install apps using downloaded installation files from your smartphones settings menu.

---

## Using the **BenQ Smart Control** app

To begin using the **BenQ Smart Control** app:

1. Choose one of the following options:
    - Connect your smartphone to the same wireless network as your projector.
    - Enable wireless hotspot for your projector and then connect your smartphone to the projector's wireless hotspot. For instructions on how to enable wireless hotspot for your projector see [Hotspot on page 91](#).
- 

 You must be connected to either the same wireless network as the projector or the projector's wireless hotspot for **BenQ Smart Control** to work correctly.

---

2. Open the **BenQ Smart Control** app  on your smartphone.

3. Select the projector from the **BenQ Smart Control** device list.

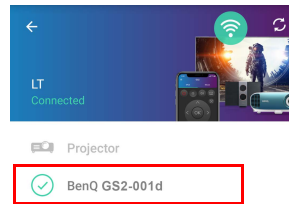

The default name for the projector is "BenQ GS2-xxxx" where the final four digits are the last four digits of its MAC Address.

---

4. Choose one of the following methods to use **BenQ Smart Control**:

- Tap **DPad** to use the pre-configured buttons in the app to control your projector.

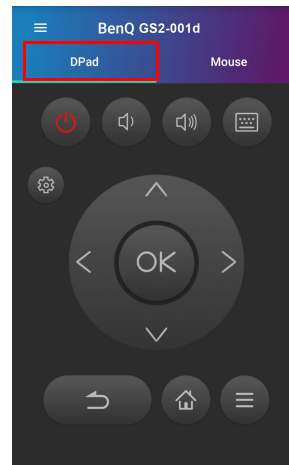

- Tap **Mouse** to use touch gestures on your smartphone to control the cursor on the projector similar to a mouse.

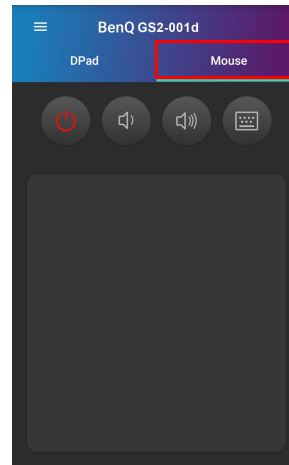



# Installation

## Choosing a location

Before choosing an installation location for your projector, take the following factors into consideration:

- Size and position of your screen
- Electrical outlet location
- Location and distance between the projector and the rest of your equipment
- Location and distance between the projector and the wireless access point, or if using a LAN cable, the internet hub

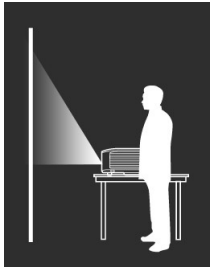
You can install your projector in the following ways.

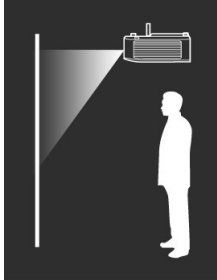
<p><b>1. Front Table:</b></p> <p>Select this location with the projector placed near the floor in front of the screen.</p> <p>This is the most common way to position the projector for quick setup and portability.</p> <p>Turn on the projector and select the following settings:</p> <p><b>Installation &gt; Projector Installation &gt; Front Table</b></p>	 A silhouette diagram showing a person sitting at a table. A projector is positioned on the table, projecting a beam of light onto a vertical screen to the left.
<p><b>2. Front Ceiling:</b></p> <p>Select this location with the projector elevated near the ceiling in front of the screen.</p> <p>Turn on the projector and select the following settings:</p> <p><b>Installation &gt; Projector Installation &gt; Front Ceiling</b></p> <p> The projector does not feature ceiling mount components/equipment so when choosing to use a front ceiling location you must place it on an elevated location of your choice.</p>	 A silhouette diagram showing a person standing. A projector is mounted on the ceiling, projecting a beam of light onto a vertical screen to the left.

### 3. Rear Table:

Select this location with the projector placed near the floor behind the screen.

Turn on the projector and select the following settings:

**Installation > Projector Installation > Rear Table**



A special rear projection screen is required.

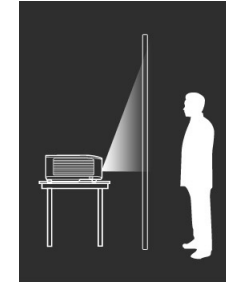

### 4. Rear Ceiling:

Select this location with the projector elevated from the ceiling behind the screen.

Turn on the projector and select the following settings:

**Installation > Projector Installation > Rear Ceiling**



A special rear projection screen is required.



The projector does not feature ceiling mount components/equipment so when choosing to use a rear ceiling location you must place it on an elevated location of your choice.

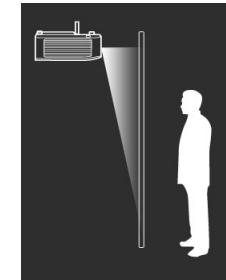

## Obtaining a preferred projected image size

The projected image size is determined by the distance from the projector lens to the screen, and the video format. The data in the table below is based on a normal projection method and not the result of adjusting the projection angle (1-15 degrees).

### Projection dimensions

Use the illustration and tables below to help you determine the projection distance.

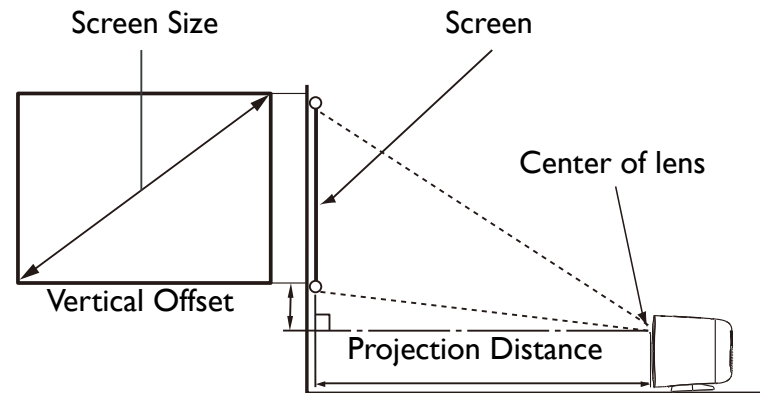

Screen size			Projector distance (mm)	
Diagonal		H (mm)	W (mm)	Average
Inch	mm			
30	762	373	664	864
35	889	436	775	1007
40	1016	498	886	1151
45	1143	560	996	1295
50	1270	622	1107	1439
55	1397	684	1218	1583

Screen size			Projector distance (mm)	
Diagonal		H (mm)	W (mm)	Average
Inch	mm			
60	1524	747	1329	1727
65	1651	809	1439	1871
70	1778	871	1550	2015
75	1905	933	1661	2159
80	2032	996	1771	2303
85	2159	1058	1882	2447
90	2286	1120	1993	2591
95	2413	1182	2104	2735
100	2540	1245	2214	2879

 All measurements are approximate and may vary from the actual sizes. If you want a permanent installation of the projector, we recommend that you use the actual projector to physically test the projection size, distance, and the projector's optical characteristics prior to the installation. This helps you determine the exact mounting position which best suits your installation.



## Installing the projector on a tripod (purchased separately)

Use a tripod plate to mount the projector onto a tripod:

1. Install the tripod's quick release plate to the projector's tripod screwhole and tighten the plate's screw.

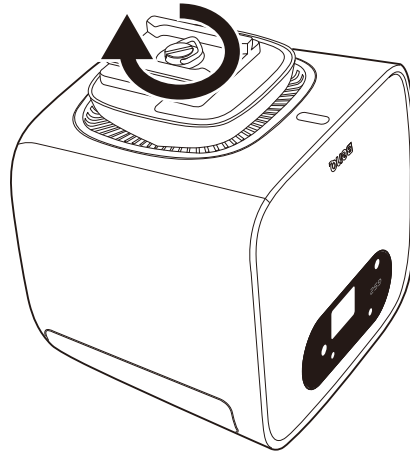

2. Install the projector onto the tripod.

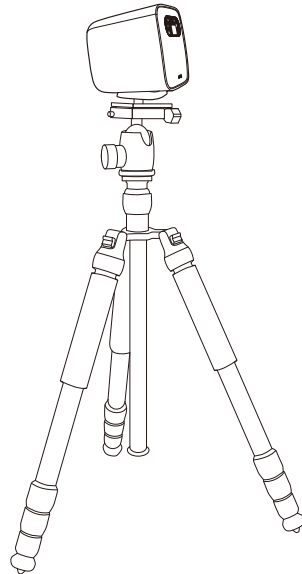

# Operations

## Installing the wireless dongle

1. Open the IO port cover.

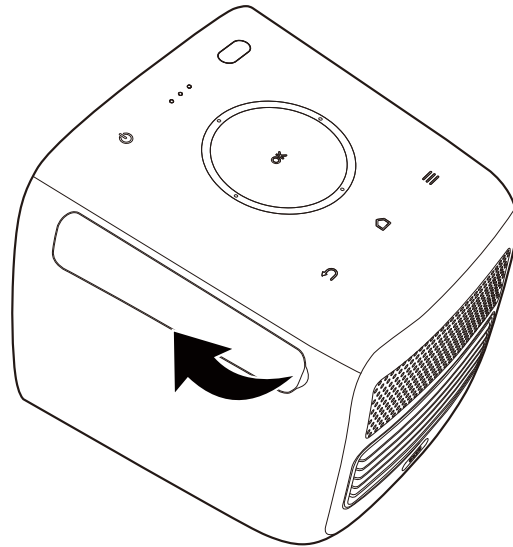

2. Remove the cap from the provided wireless dongle (WDR02U).

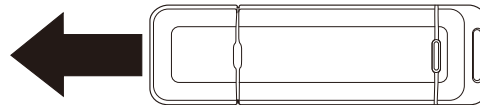

3. Orient the dongle so that the dongle's LED is facing up and then insert the dongle into the wireless dongle port.

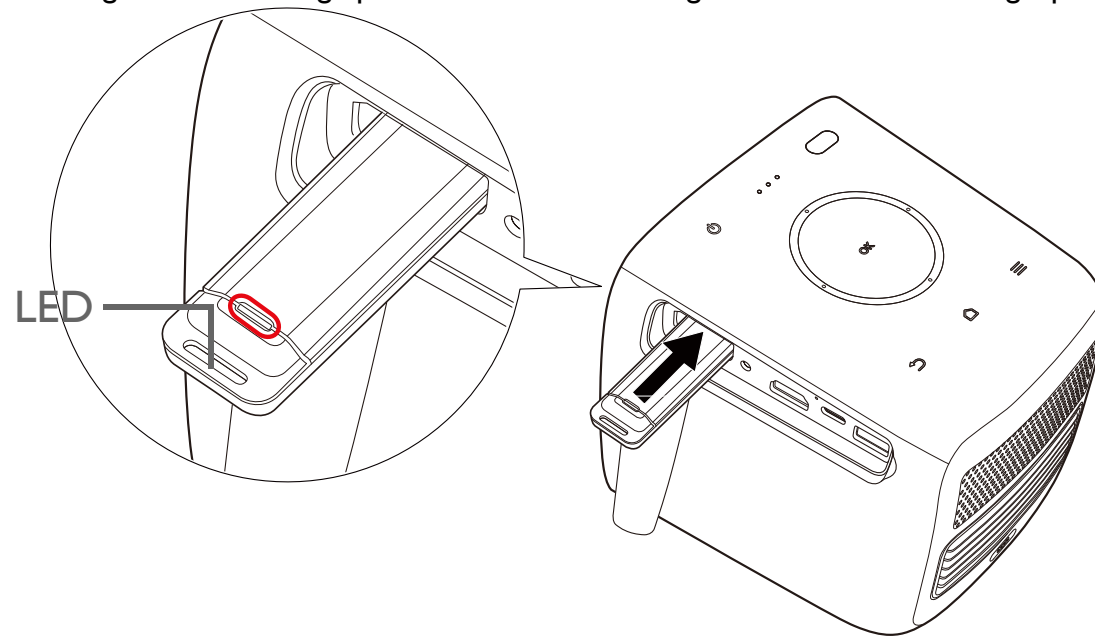

4. Re-install the IO port cover.

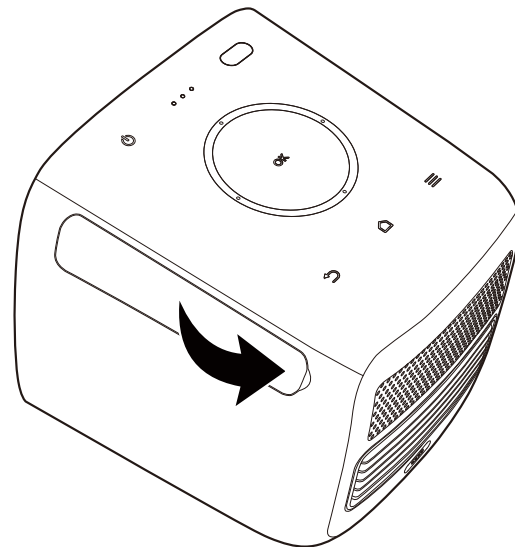

## Charging the battery

1. Connect the power cord to the power adapter.
2. Orient the adapter connector to the projector's power adapter port.
3. Charge the projector's battery by connecting the power cord to a power outlet.

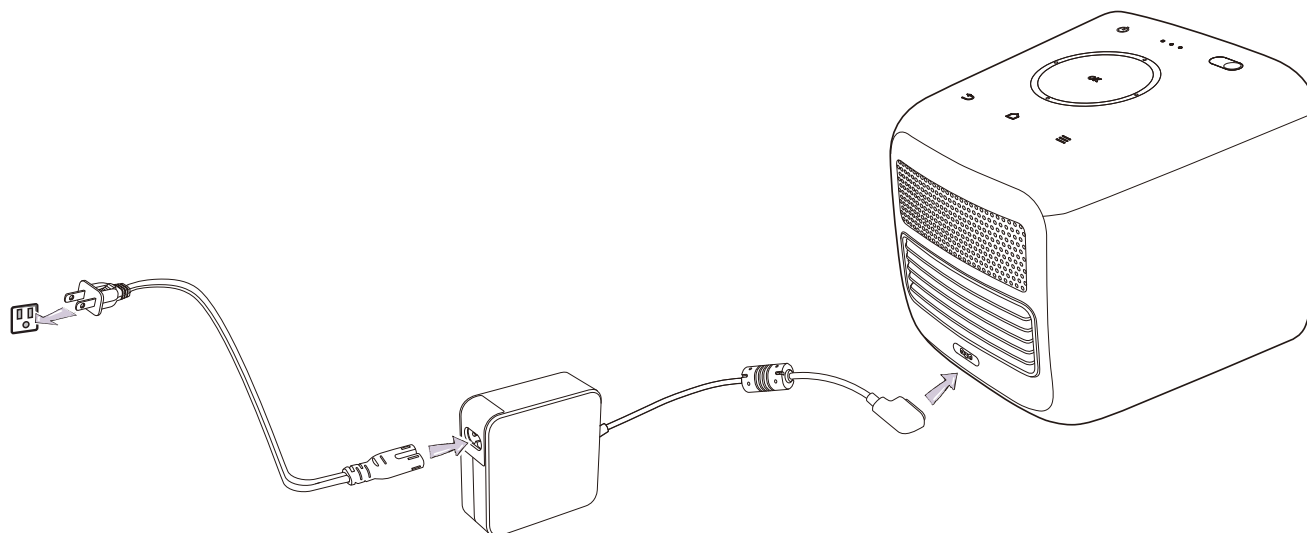

The power LED indicator will illuminate according to its charge status, for a full charge wait until the indicator lights up solid green (see [LED Indicators on page 19](#) for more information on LED behavior).

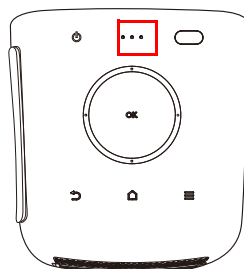

---

 Keep the battery charged to at least 60% (3 bars on the battery status icon) to ensure a successful OTA update.

---

## Starting up the projector

1. Install the provided wireless dongle into the wireless dongle port on the right side of the projector. See [Installing the wireless dongle on page 34](#) for details.
2. Charge the battery or supply power to the projector as indicated in [Charging the battery on page 36](#).
3. Press and hold the power key  for 3 seconds. The LED indicator on the projector lights up and “breathes” green after power has been applied. It will then illuminate according to its charge setting (see [LED Indicators on page 19](#)).

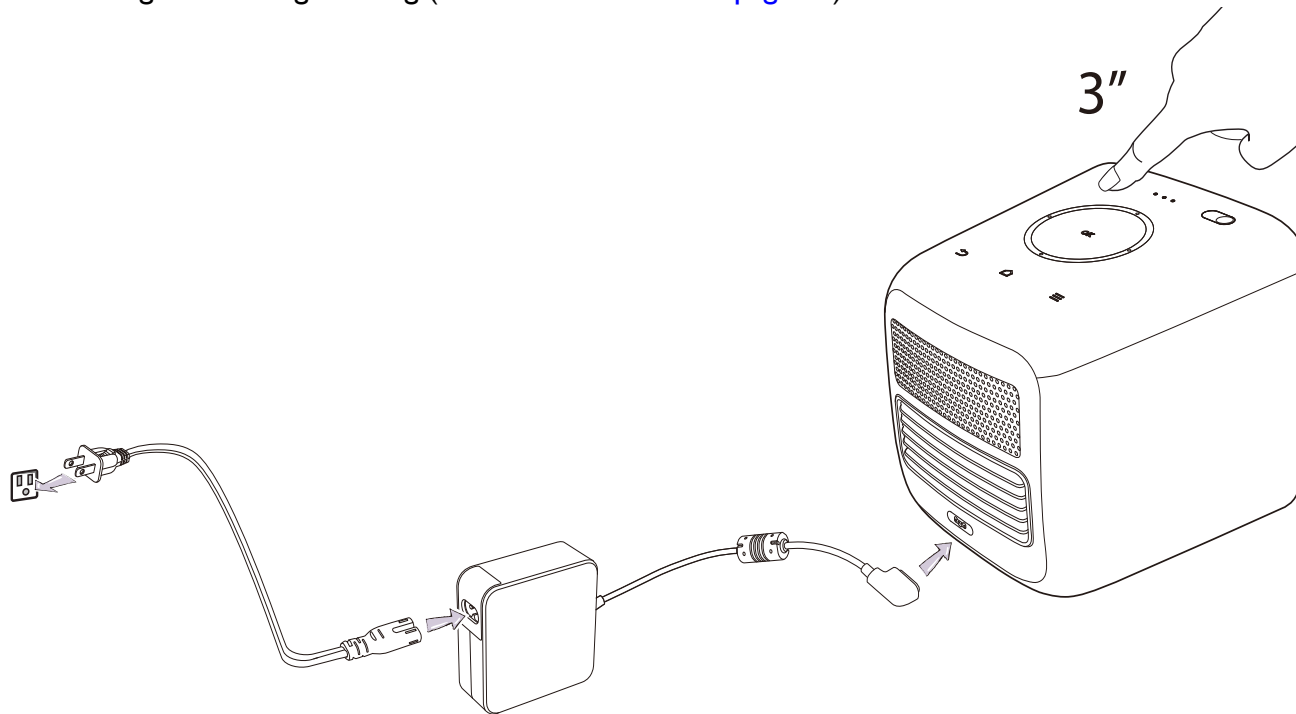

- 
-  The power button on the remote control is not able to power on the projector. Powering on the projector can only be done using the power key on the top side of the projector.
  - When supplying power directly to the projector please use the supplied power cable to avoid possible dangers such as electric shock and fire.
- 

-  Press the power button to enter power-saving mode when the projector is on.
-

4. Connect any video equipment supporting HDMI or DisplayPort (version 1.1 or above) or a storage device to the USB-C™ or USB-A port on the right side of the projector. If you want to project video via a wireless connection or if you want to access the **BenQ Launcher**, you do not need to connect any video equipment.

---

 For more details on connection options, see [Connections on page 52](#).

---

5. The fans start operating, and a start-up image will be shown while the projector warms up. This process may take a few minutes. The projector does not respond to further commands while it is warming up.
6. If this is the first time you turn on the projector, the setup wizard appears to guide you through setting up the projector. If you have already done this, skip this step.
  - Use the arrow keys (◀/▶/▲/▼) on your remote control to move through the menu items.
  - Use **OK** to confirm the selected menu item.
  - Use **Back** to return to the previous menu.
  - Use **MENU** to skip a menu.

---

 The Setup Wizard screenshots below are for reference only and may differ from the actual design.

---

Step 1:

Choosing a **Installation settings**.

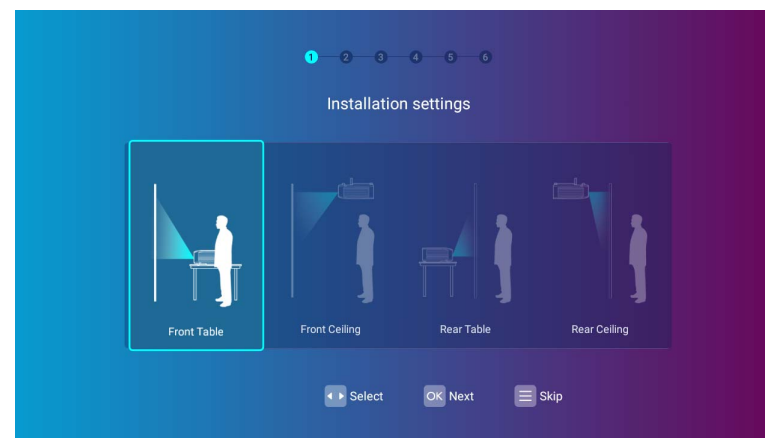

Step 2:  
Choosing a **Language settings**.

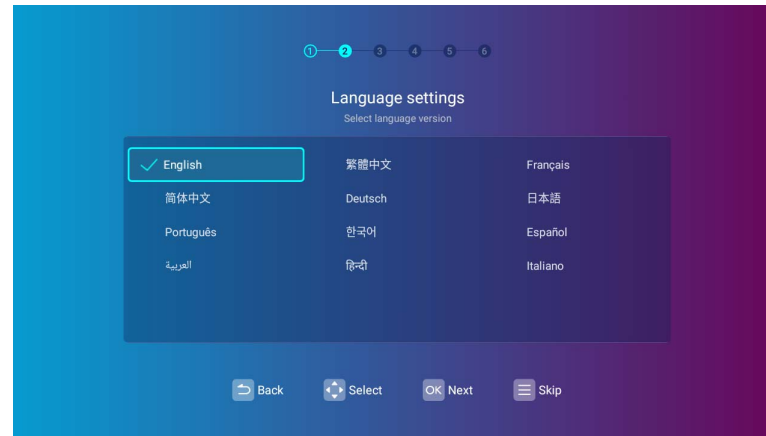

 Available languages may vary by the product supplied for your region and may be updated without prior notice.

Step 3:  
Adjusting **Keystone**.

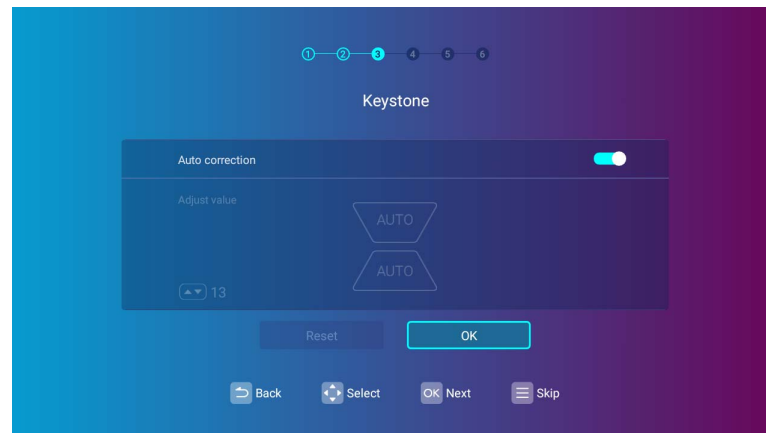

#### Step 4:

Configure the wireless settings by selecting the wireless network and entering the password.

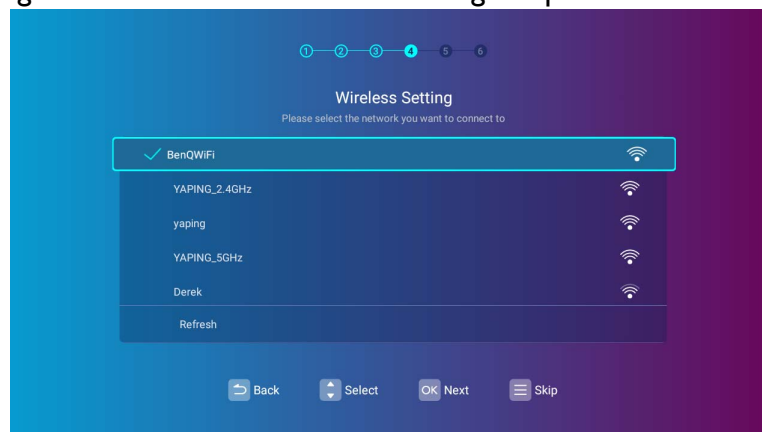

To connect to a hidden wireless network select **Add a new network** and enter the SSID, security setting, and password for the network.

#### Step 5:

Specify **Time zone settings**.

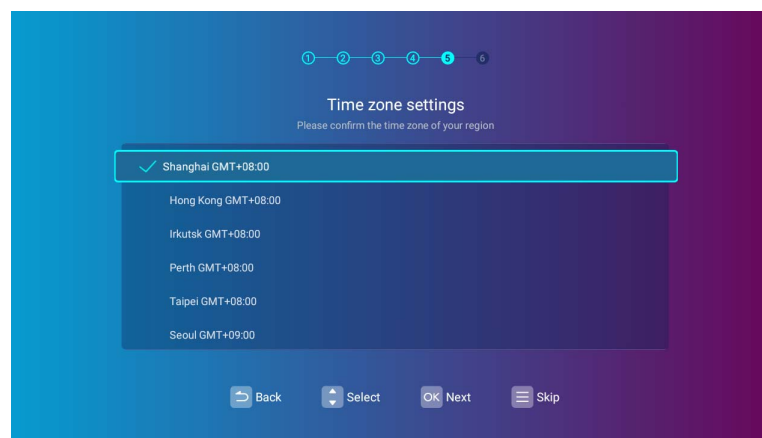



Step 6:

Read the **Personal information declaration** and press **Agree**.

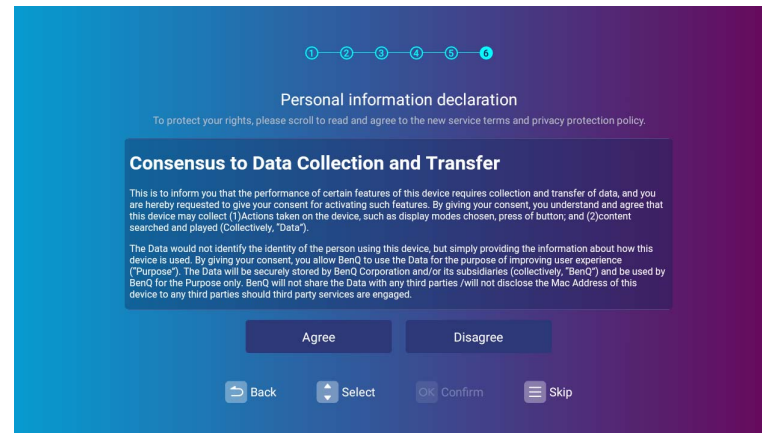

You've completed the setup wizard; you may now connect a device to the projector to project video. See [Connections on page 52](#) for more information.

## Shutting down the projector

1. Press and hold the power key  on the projector or your remote control for 3 seconds. The projector displays a shutdown confirmation message.
2. The power LED indicator turns off and will illuminate again according to its charge status if the adapter is connected to the projector (see [LED Indicators on page 19](#)). The fans may continue to run in order to cool the lamp.

If the projector will not be used for an extended period, unplug the power cable from the power outlet.

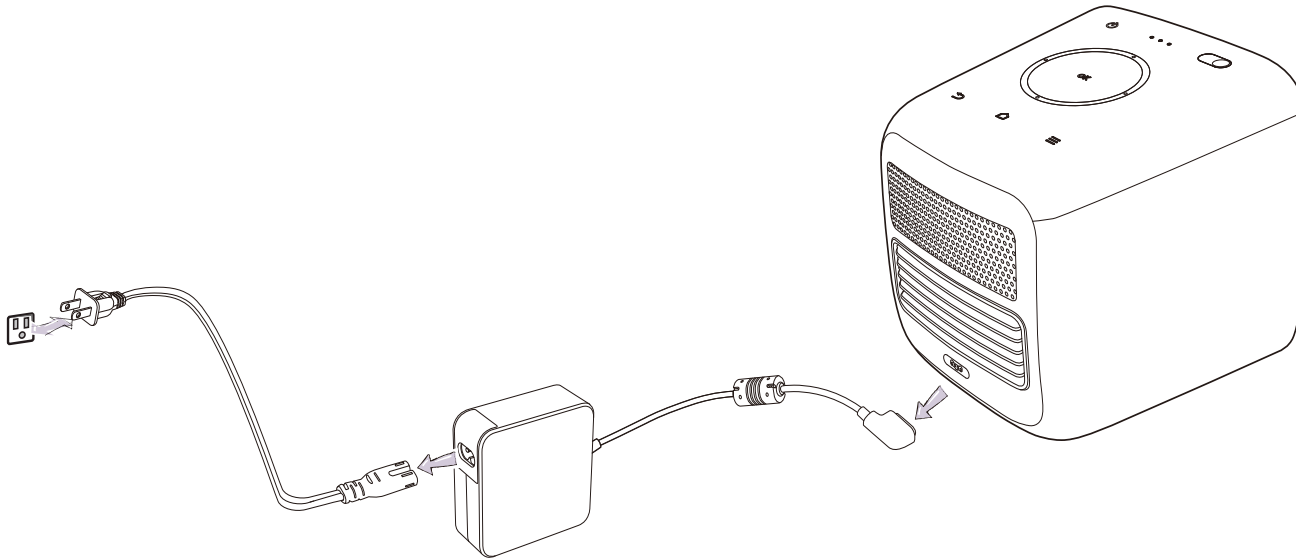

Avoid turning on the projector immediately after turning it off as excessive heat may shorten lamp life.

# Adjusting the projected image

## Adjusting the projection angle

The projector is equipped with a pivoting head which changes the image height and projection angle.

To adjust the projection angle:

- Pivot the head upwards or downwards until the image is positioned as desired.

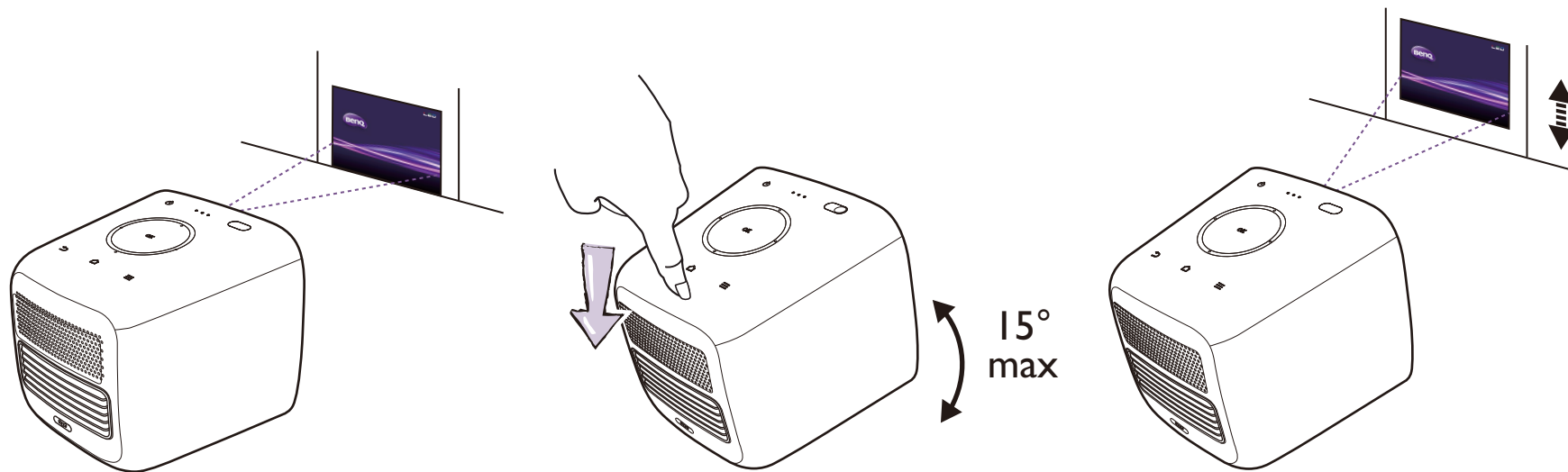

- 
-  The maximum angle of adjustment is 15 degrees.
  - If the screen and the projector are not perpendicular to each other, the projected image becomes vertical trapezoidal. To correct this, see [Correcting keystone on page 45](#) for details.
-

## Fine-tuning the image clarity

To sharpen the picture, short press the focus key (⊕) on the remote control.

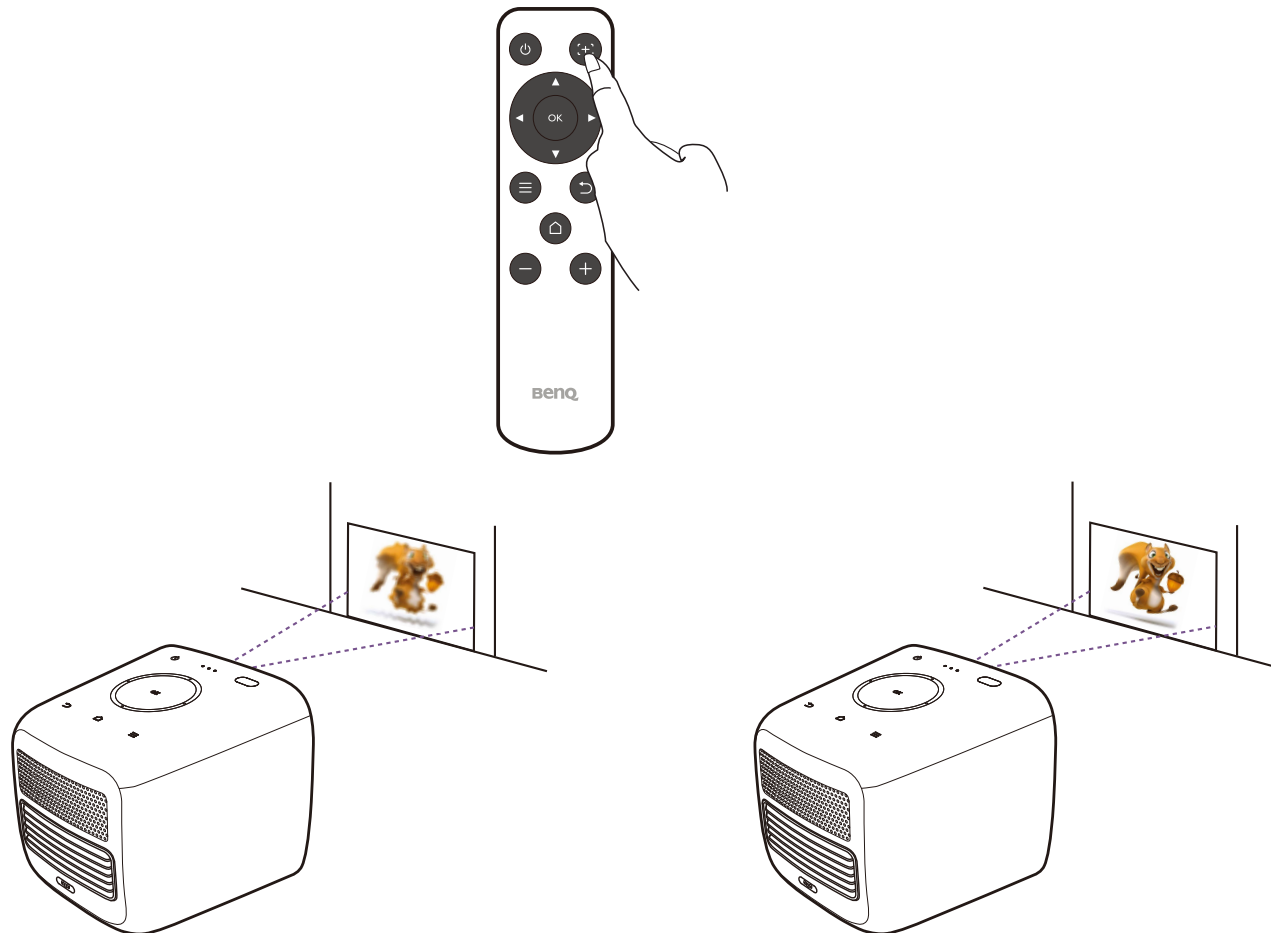

- Do not look into the lens while the lamp is on. The strong light from the lamp may cause damage to your eyes.
- You may also fine tune the image in **BenQ Launcher**. See [Auto Focus on page 97](#) for more information.

## Correcting keystone

Keystoning refers to the situation where the projected image is noticeably wider at either the top or bottom. It occurs when the projector is not perpendicular to the screen.

To adjust the **Keystone**:

1. Press the down arrow key ▼ on the remote control three times to navigate to the settings menus.
2. Select **Settings** and press **OK**.
3. Select **Keystone** and press **OK**.
4. Disable the **Auto Keystone** setting.
5. Select **Keystone adjustment** and press **OK**.

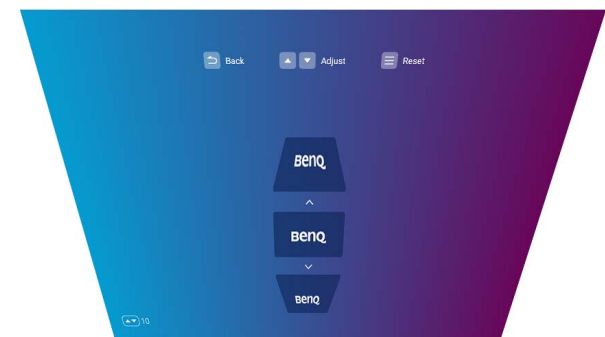
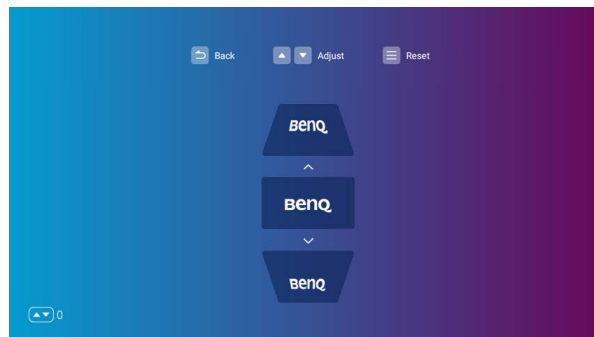
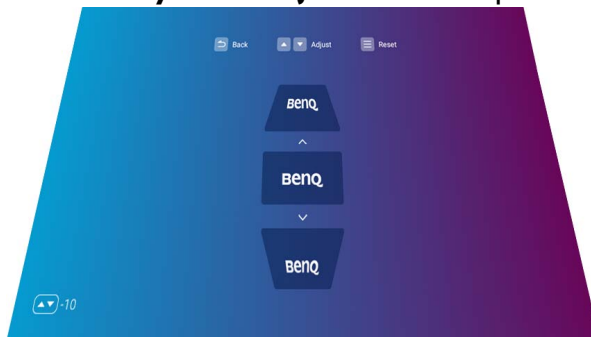

- To correct keystone at the top of the image, use ▲ on your remote control.
- To correct keystone at the bottom of the image, use ▼ on your remote control.
- To return to default keystone settings press ≡ on your remote control



You may only make these adjustments if **Auto Keystone** is disabled in the Installation menu. See [Keystone on page 98](#) for details.

6. When you are done adjusting the keystone, press ⇨ to save your changes and return to the previous menu, or press ⇩ to save your changes and go back to the home screen directly.

# BenQ Launcher

**BenQ Launcher** is the projector's operating system that allows you to project videos wirelessly, play media files or streaming apps, as well as adjust projector settings.

 Use your remote control to operate **BenQ Launcher** functions. The projector's control panel keys are limited to control projector functions.

## The BenQ Launcher home screen

When the projector is not projecting an image from a connected source it will display **BenQ Launcher** by default. If the projector is projecting from a source, you can return to **BenQ Launcher** mode by pressing  on your remote control.

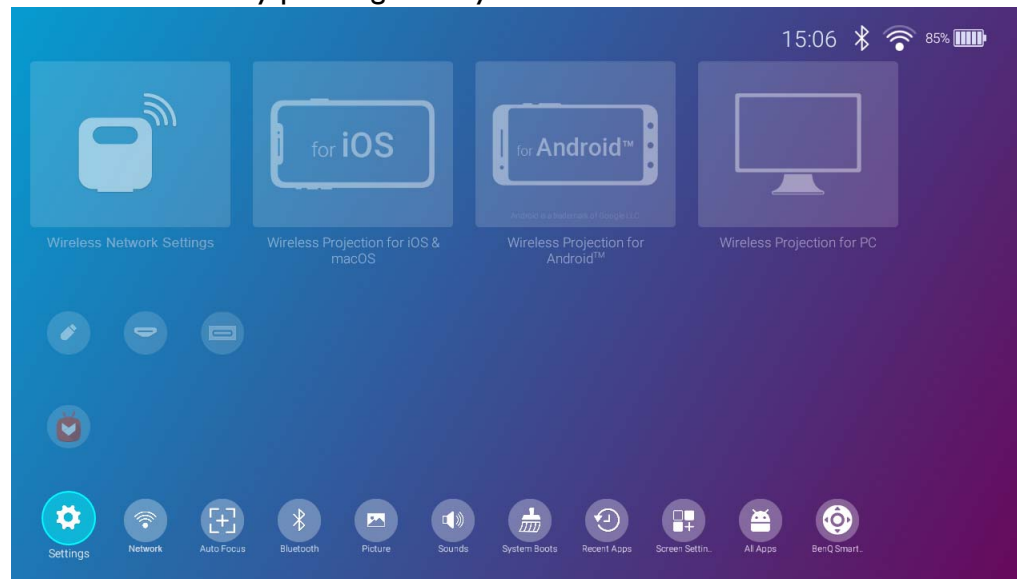

- 
- Actual screen may vary based on your BenQ Launcher firmware version.
  - Keep the battery charged to at least 60% (3 bars on the battery status icon) to ensure a successful OTA update.

The **BenQ Launcher** home screen features five main sections:

- **Status Bar icons** - Icons that display the time, wireless and battery status.
- 

 You may hide the battery status icon from the home screen. See [Battery on page 108](#) for details.

---

- **Wireless Projection buttons** - Provides instructions on how to project wirelessly via iOS/Android devices or a laptop/PC.
  - **Source menu** - Allows you to select the video input source connected to the HDMI, USB-A, or USB-C™ ports for projection.
- 

 Only video devices with DisplayPort (version 1.1 or above) functionality or USB-C™ flash drives can project via the USB-C™ connection.

---

- **App Shortcuts** - Quick access to the **Aptoide** app market and other apps.
  - **Settings menus** - Shortcuts to the settings menus to adjust wireless, Bluetooth and other settings.
- 

 Press the down button ▼ on the remote control to access the **Settings** menus.

---

## Navigating the **BenQ Launcher** home screen

1. From the **BenQ Launcher** home screen, press ◀/▶/▲/▼ on your remote control to select the desired function and press **OK**.
2. Follow on-screen instructions for further operations.

## Using the source menu

Press the down button ▼ on the remote control from the **BenQ Launcher** home screen to access the **Source** menu, which displays the input source options: **File Manager**, **HDMI**, and **USB Type C**. Press **OK** to select the desired input source. See [Wired Connections on page 67](#) for more information.

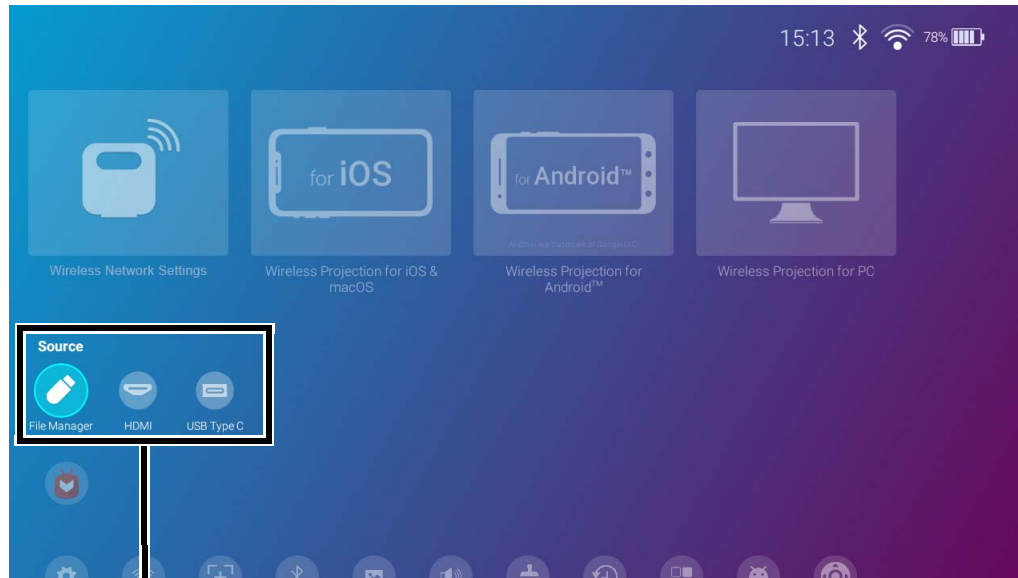

Source Menu



## Using the app shortcuts

Press the down button ▼ on the remote control twice from the **BenQ Launcher** home screen to access the app shortcuts section, which displays the pre-installed **Aptoide** app market for streaming apps, as well as other apps that have been installed on the projector. Other default apps may appear based on language settings.

Up to ten shortcuts are allowed in this block. To access all the apps installed on the projector, see [All Apps on page 90](#). For details on how to re-order the shortcuts see [Screen Settings on page 99](#).

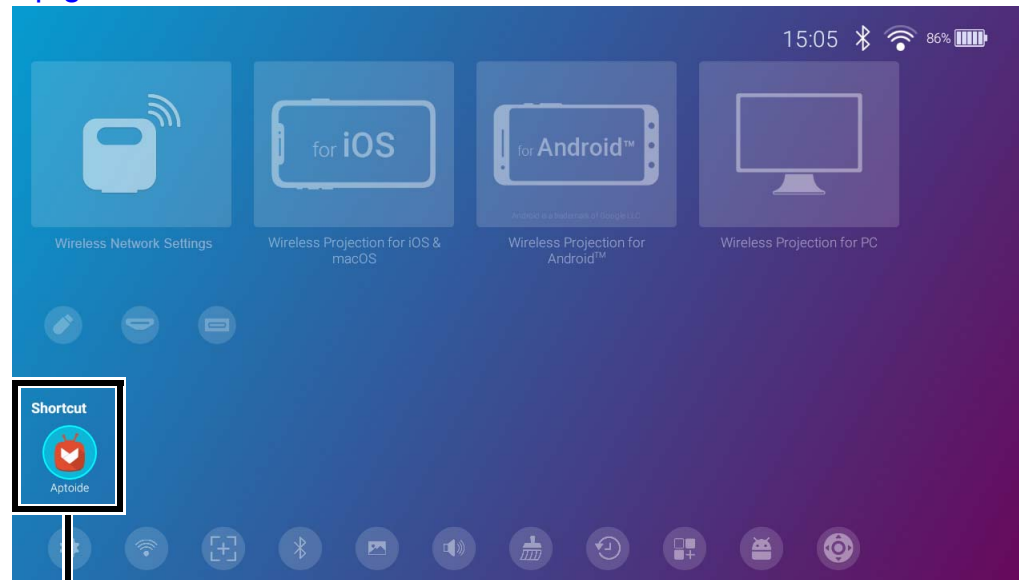

App Shortcuts

## Using the **BenQ Launcher Settings** menus

Press the down button ▼ three times on the remote control from the **BenQ Launcher** home screen to access the settings menu section, which features a button for the projector's full settings menu as well as shortcut buttons for various sub-menus within the settings menus.

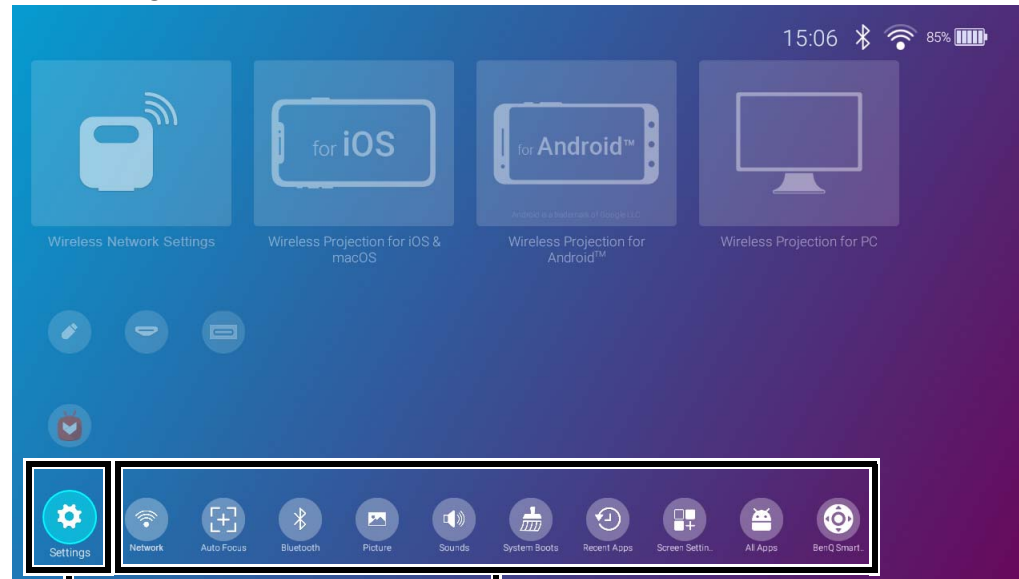

Full **Settings** Menu

Sub-Menu Shortcuts

---

 Actual screen may vary based on your BenQ Launcher firmware version.

---

For more information on the settings menus see [About the Settings menu on page 84](#).

## Inputting text

Various menus within the **BenQ Launcher** may require that you input text. To input text in a text field:

- I. Select the text field where you want to input text.

2. Press **OK** on your remote control, and a full alphanumeric keyboard will appear on screen.
  3. Press ◀/▶/▲/▼ on your remote control to navigate the keyboard, and press **OK** to select the letter/key/symbol you want to enter into the text field.
  4. Press ⇨ at anytime to exit out of the keyboard.
- 



Actual keyboard types may vary based on your language preference setting. See [Keyboard on page 103](#) for more information.

---

# Connections

You can connect your device to the projector in various ways to project video content.

## Wireless Connection

- Smartphone, tablet, laptop/PC

## Wired Connection (HDMI port)

- A/V device.
- Smartphone, tablet, laptop/PC

## Wired Connection (USB-A port)

- USB-A flash drive

## Wired Connection (USB-C™ port)

- USB-C™ flash drive
- Smartphone, tablet, laptop/PC

- 
-  • Devices connected via the USB-C™ port require a USB-C™ cable and must support DisplayPort (version 1.1 or above) functionality in order to project video.
  - When the projector is running on battery power (not connected to a power source), it will not charge or provide power to any devices connected to the USB-C™ port. Only when the projector is connected to a power source will it be able to charge or provide power to devices connected to the USB-C™ port.
- 

Furthermore, you can also connect the projector to Bluetooth speakers/headphones to broadcast audio through the speakers/headphones or connect a mobile device to the projector via Bluetooth to broadcast audio through the projector's speakers.

Before connecting a signal source to the projector, be sure to:

- Open the IO cover.
- Install the provided wireless dongle (WDR02U) for wireless connection.
- Place the projector within range of the wireless AP you plan to connect it to.
- Use the correct signal cables for each source.
- Make sure the cables are firmly inserted.

Wireless Connection:

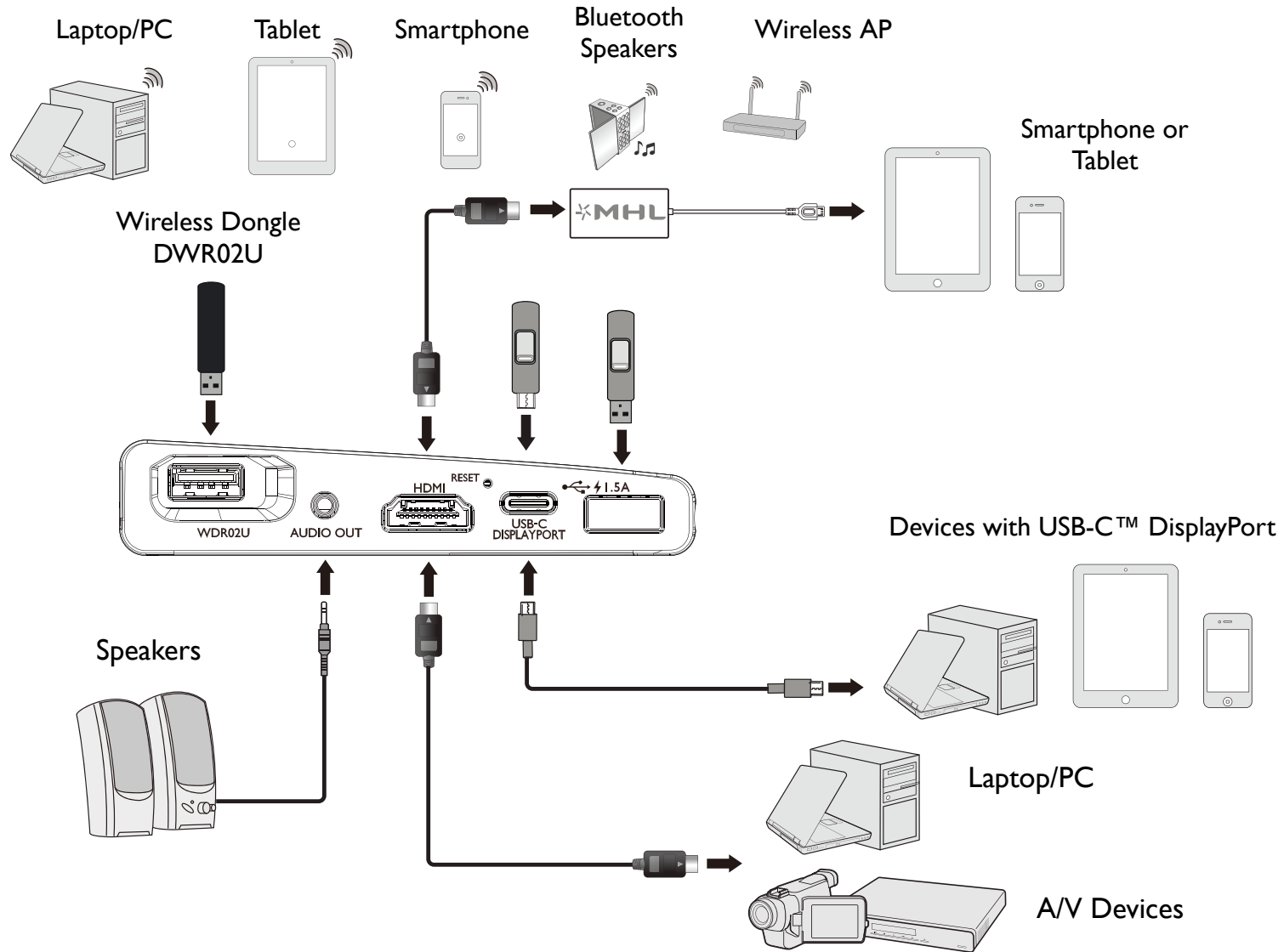

 The illustration above is for reference only.

# Wireless Connections

## Connecting the projector to a wireless network

Before you can project wirelessly via the projector you must first connect the projector to a wireless network. To connect your projector to a wireless network, or to switch wireless networks:

---

 If you have already connected the projector to a wireless network during the setup wizard you may skip the steps in this section.

---

1. Install the provided wireless dongle into the wireless dongle port (see [Installing the wireless dongle on page 34](#)).
2. Power on the projector (see [Starting up the projector on page 37](#)).
3. On the home screen of the **BenQ Launcher** interface, select **Wireless Network Settings** and press **OK** to access the wireless settings.

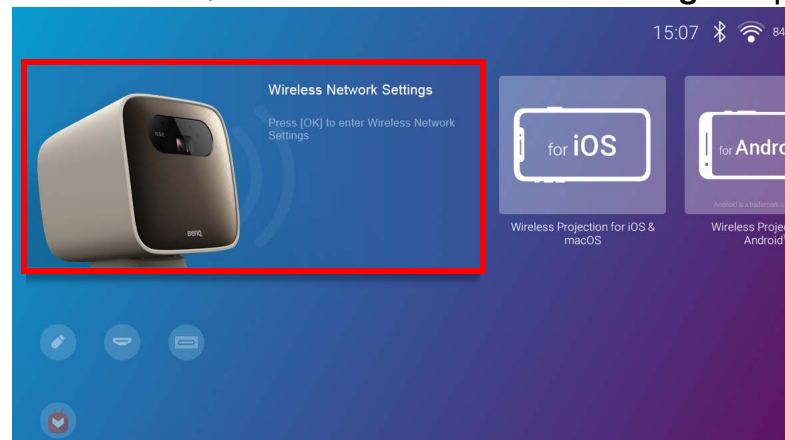

4. Select **Wireless Network** and press **OK** to enable wireless connectivity.

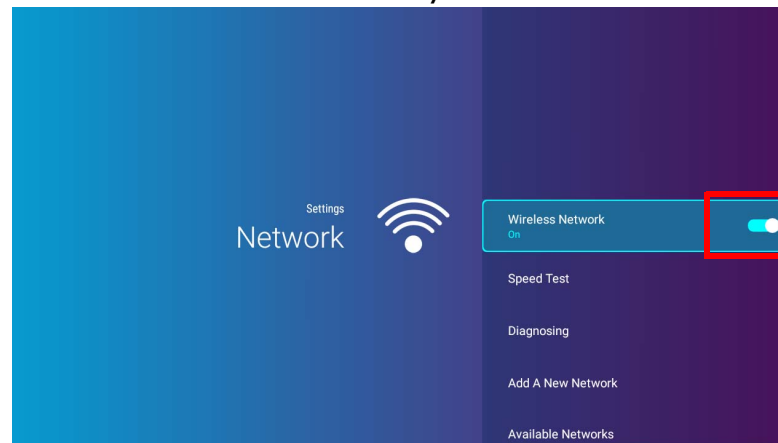

5. Select the SSID for the wireless AP you want to connect to and press **OK**.

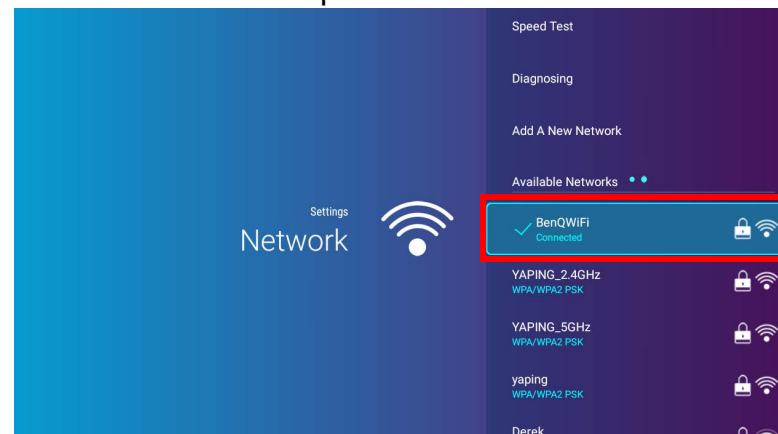

- To connect to a hidden wireless network select **Add A New Network** and enter the SSID, security setting, and password for the network.
- The list of available wireless networks will be refreshed every 10 seconds. If the desired SSID is not listed please wait for refreshing to complete.

6. If you chose a secured SSID for the first time, a window appears prompting you to enter the appropriate password. Use the virtual keypad to enter the password. After you have entered the password, select **Next** and the projector will automatically connect.

- The password will be stored in the projector's memory. In the future, if you select the same SSID again, you will not be prompted to enter a password unless you delete the SSID from the projector's memory.
- If the password is typed incorrectly, you can select either ↩ to return to the virtual keypad or **Available Networks** to return to the list of SSIDs.

7. Once you have successfully connected to the wireless AP a wireless connection icon will appear at the top right corner of the **BenQ Launcher** interface. You can now connect your devices wirelessly to the projector to project videos..

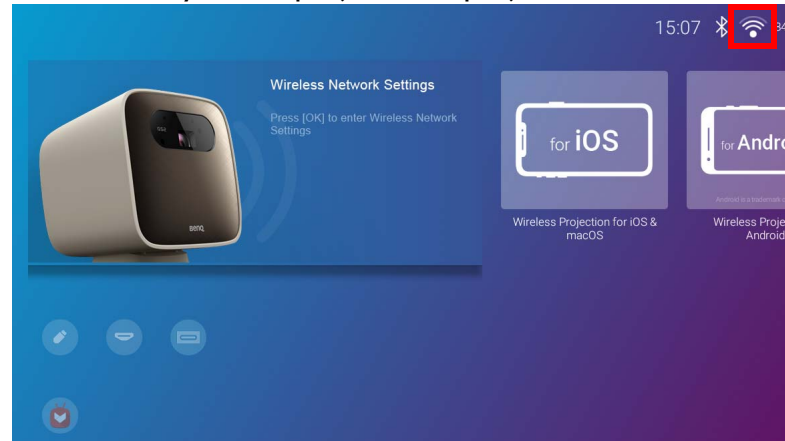



## Wireless Projection for iOS & macOS®

To connect an iOS device to the projector and project video via AirPlay:

1. On the home screen of the **BenQ Launcher** interface, select **Wireless Projection for iOS & macOS** and press **OK**.

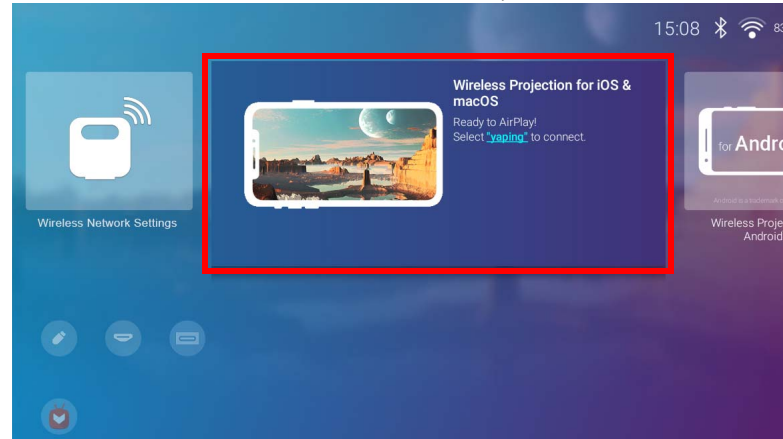

2. On your iOS mobile device's network menu connect to the wireless network shown on the **Wireless Projection for iOS & macOS** screen and then select **Next**.

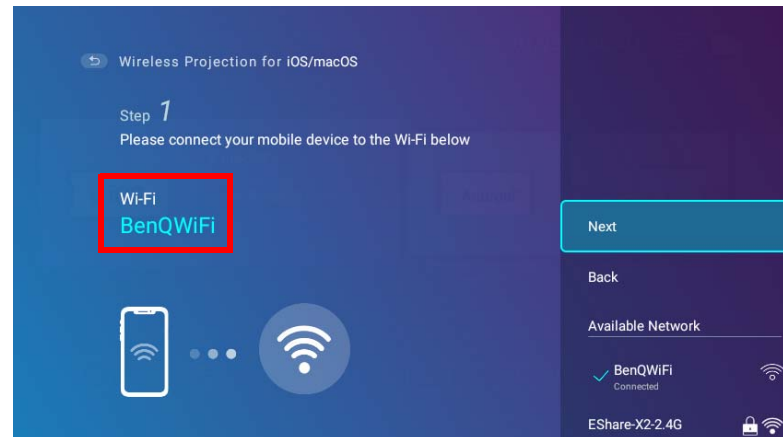

3. Follow the instructions shown on the **Wireless Projection for iOS & macOS** screen to project your iOS device's screen via AirPlay.

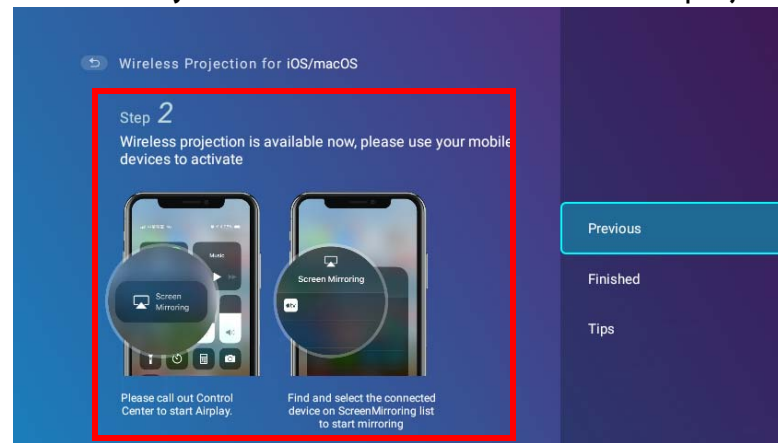

4. Select **Finished** on the **Wireless Projection for iOS & macOS** menu to finish the tutorial and return to the home screen.

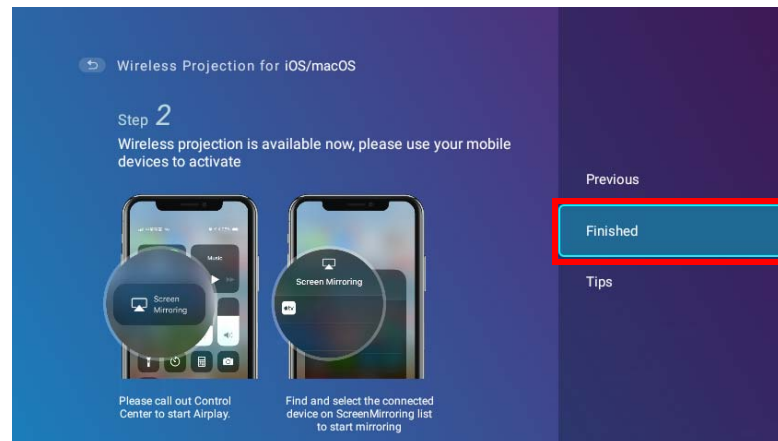

Once you have finished projecting, disable AirPlay on your iOS device to end the connection.

## Wireless Projection for Android™

To connect an Android™ device to the projector and project video:

1. On the home screen of the **BenQ Launcher** interface, select **Wireless Projection for Android™** and press **OK**.

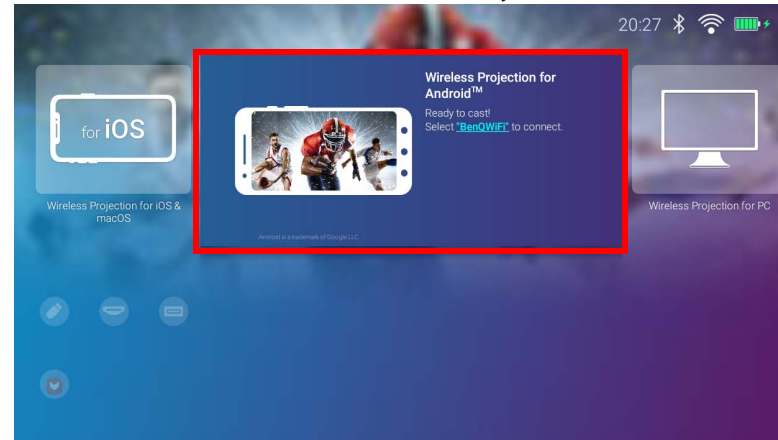

2. On your Android mobile device's network menu connect to the wireless network shown on the **Wireless Projection for Android™** screen and then select **Next**.

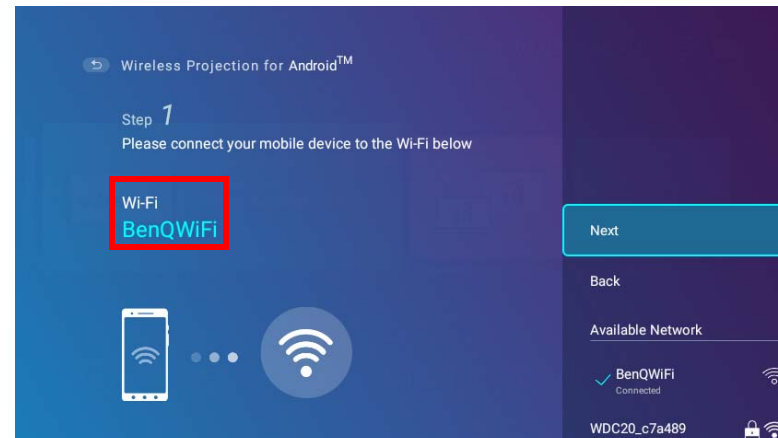

3. Follow the instructions shown on the **Wireless Projection for Android™** screen to project your Android device's screen.

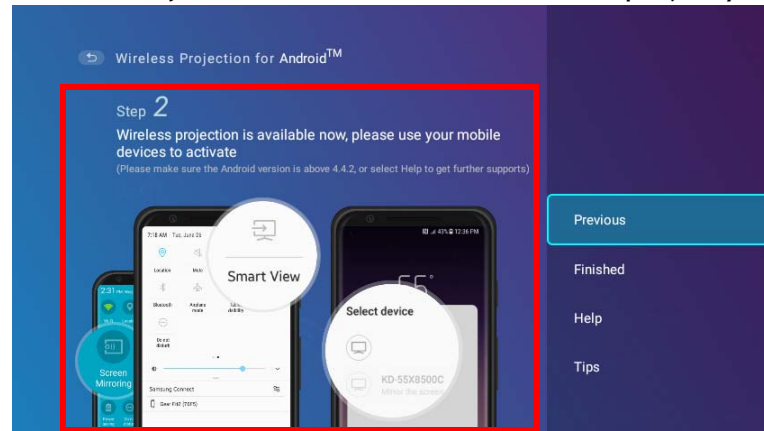

4. Select **Finished** on the **Wireless Projection for Android™** screen to finish the tutorial and return to the home screen.

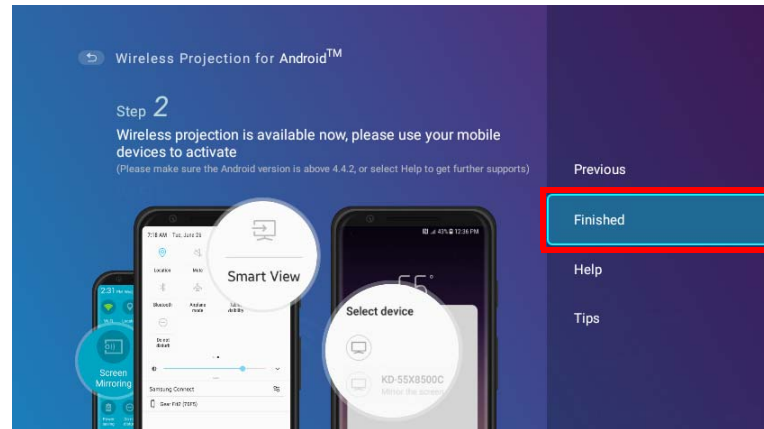

Once you have finished projecting, disable screencasting on your Android device to end the connection.

# Wireless Projection for PC

To connect a PC to the projector and project video:

1. On the home screen of the **BenQ Launcher** interface, select **Wireless Projection for PC** and press **OK**.

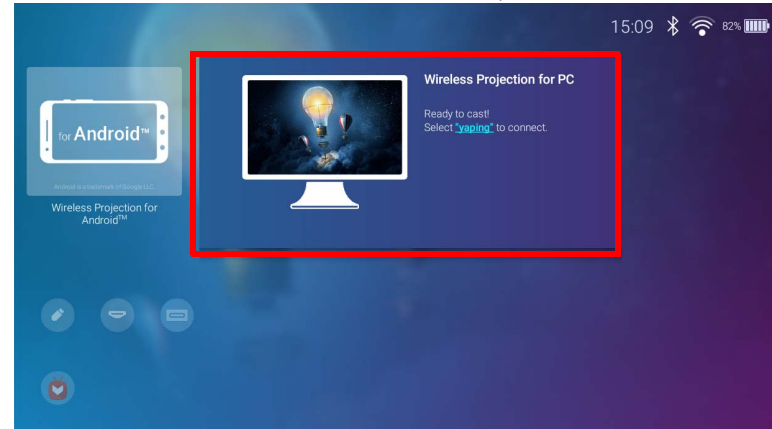

2. On your PC's network menu connect to the wireless network shown on the **Wireless Projection for PC** screen and then select **Next**.

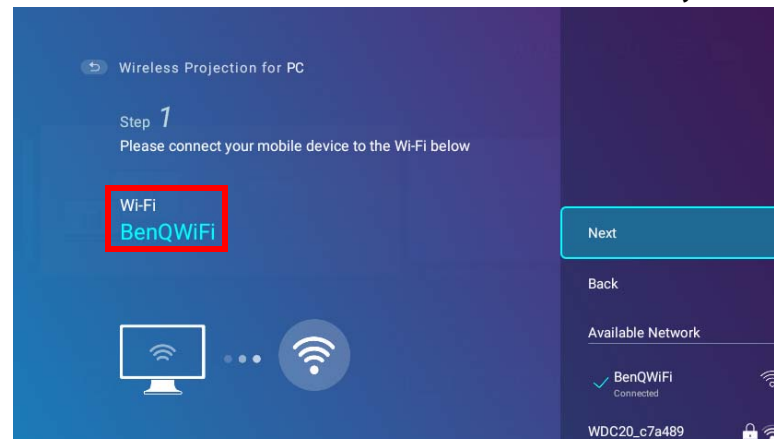

3. Follow the instructions shown on the **Wireless Projection for PC** screen to project your PC's screen.

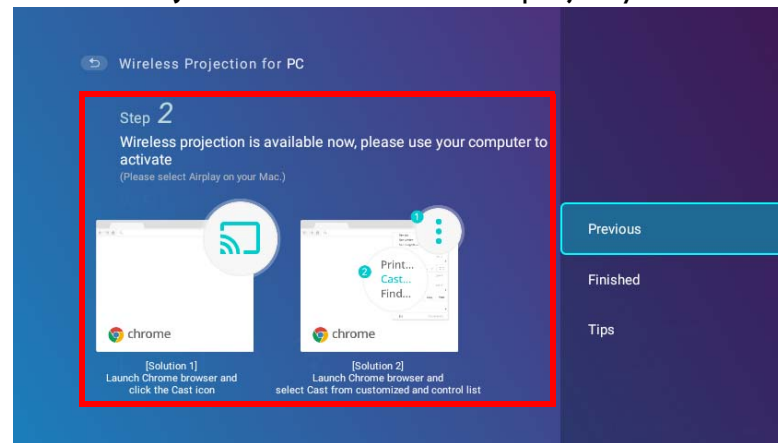

4. Select **Finished** on the **Wireless Projection for PC** screen to finish the tutorial and return to the home screen.

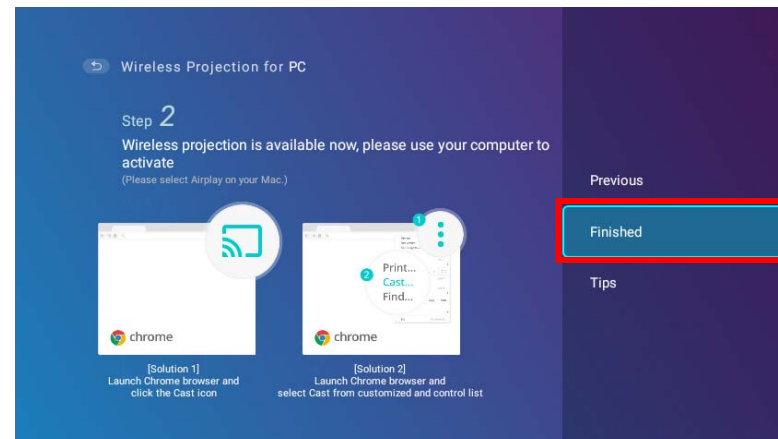

Once you have finished projecting, disable screencasting on your PC to end the connection.

# wireless Hotspot

In situations where the projector is out-of-range of a wireless network (for example while on a camping trip), you can configure the projector to act as a wireless hotspot to create a closed network for devices to connect directly to the projector via a wireless connection and to project files from their local storage.

---

 The projector will have no access to the Internet while in wireless hotspot mode.

---

To create a wireless hotspot:

1. Install the wireless dongle provide into the wireless dongle port (see [Installing the wireless dongle on page 34](#)).
2. Power on the projector (see [Starting up the projector on page 37](#)).
3. On the home screen of the **BenQ Launcher** interface, press the down arrow key ▼ on the remote control three times to navigate to the settings menus.
4. Select **Settings** and press **OK**.

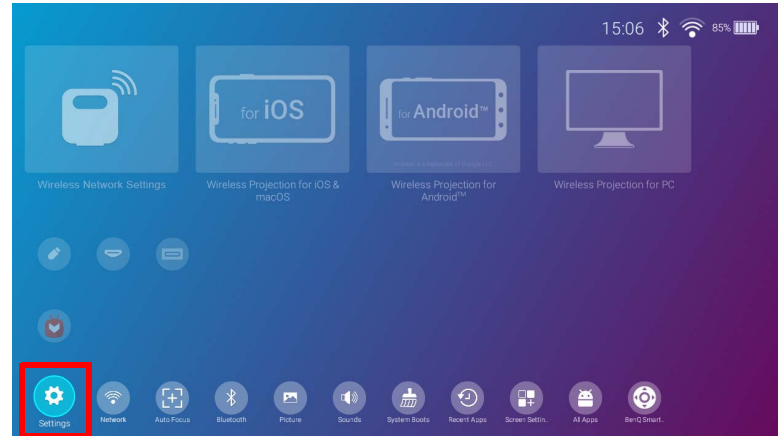

5. Select **Hotspot** and press **OK**.

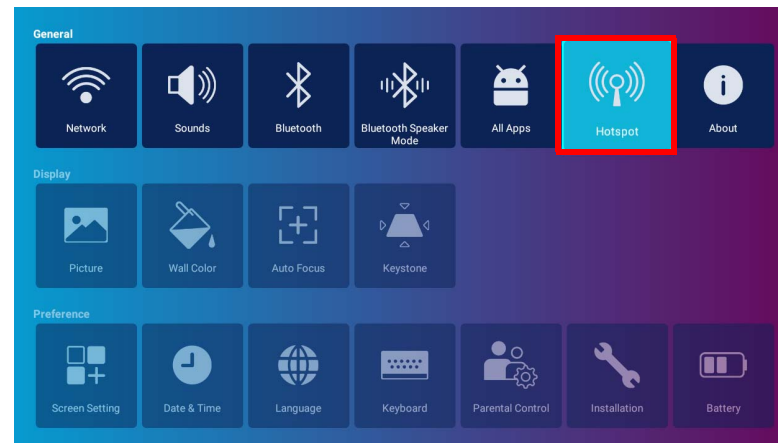

6. (Optional) Select **Hotspot Password** and press **OK** to change the password of the wireless hotspot.

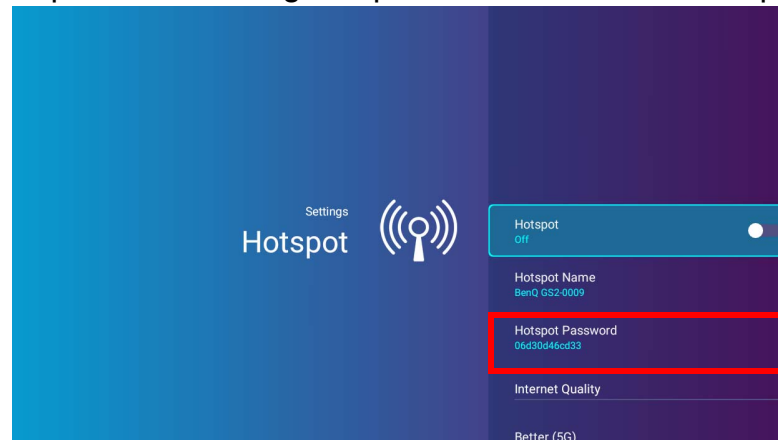

The **Hotspot Name** and the **Hotspot Password** can only be changed when **Hotspot** is disabled.



7. Select **Hotspot** and press **OK** to enable wireless hotspot.

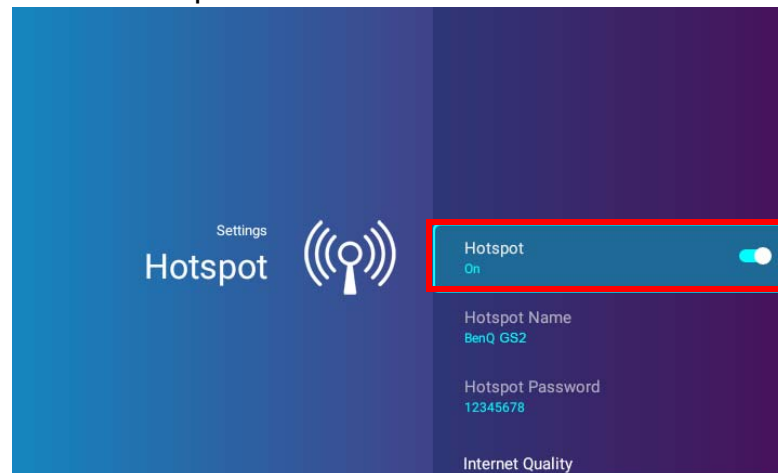

8. Once wireless hotspot is enabled, use the name shown in the **Hotspot Name** field as the SSID to connect to from your mobile device's network menu and use the password shown in the **Hotspot Password** field as the connection password.

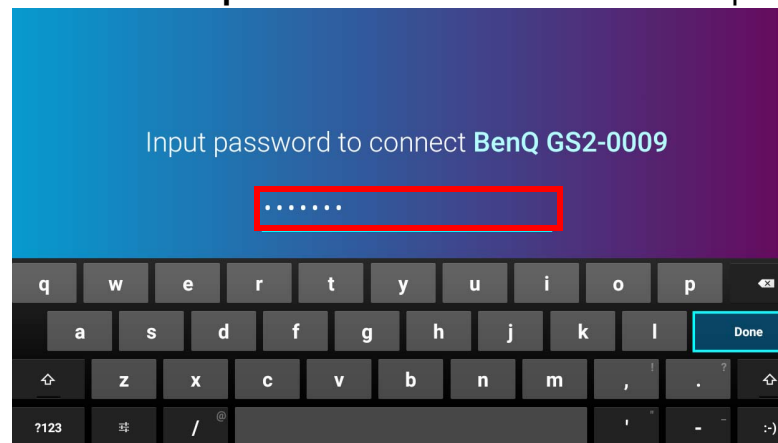

9. If the wireless hotspot can not be found by your device, select **Normal(2.4G)** under the **Internet Quality** heading.

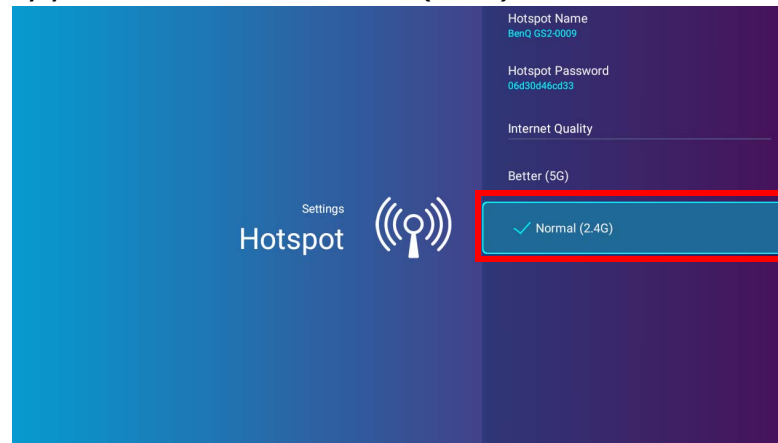

After the wireless hotspot is setup, follow the corresponding connection instructions described in the previous section(s) to connect to the projector directly and project video.

# Wired Connections

## Connecting a device with HDMI or USB-C™ with DisplayPort

Using an HDMI or USB-C™ Gen3.1 cable you can connect a device that is equipped with HDMI or DisplayPort capabilities to broadcast videos and images on the projector.

---

 Not all devices with a USB-C™ cable have DisplayPort functionality. Check your device's documentation for clarification.

---

To connect a device with HDMI or USB-C™ with DisplayPort:

1. Connect the device to the HDMI or USB-C™ port on the right side of the projector.
2. A pop-up notification will appear indicating that a device is connected to the projector. Select **OK** to connect to the device.

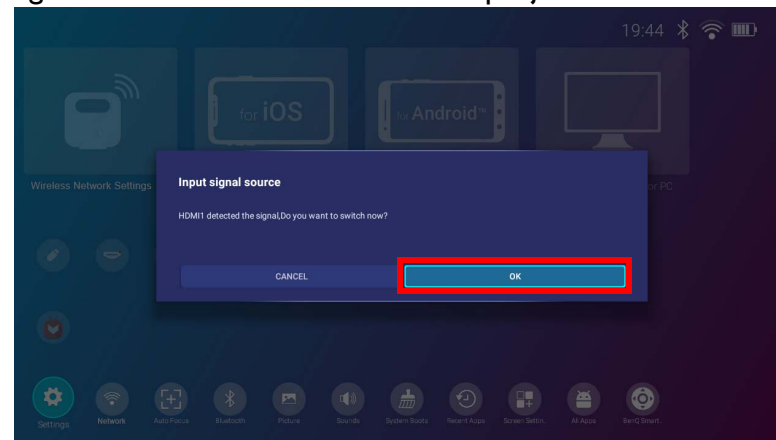

3. The projector will attempt to connect to the device's signal.

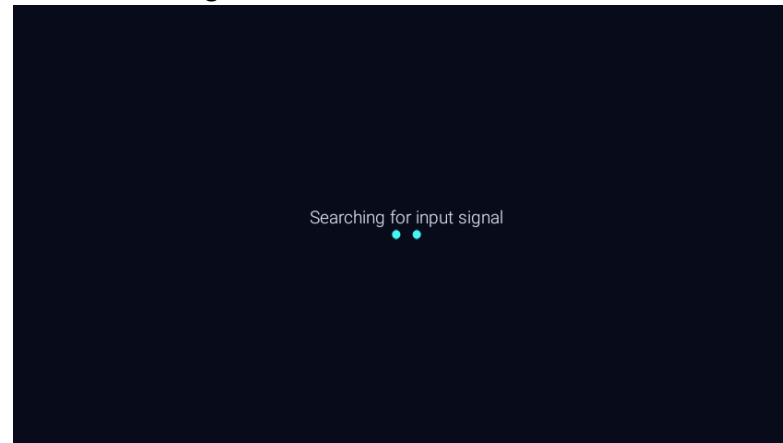

4. The video from the device will automatically be displayed full screen once the signal from the device is detected.

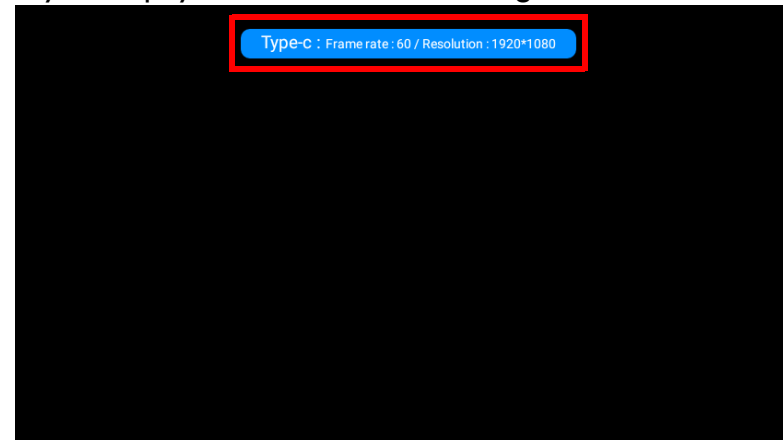

5. If no signal is detected or the signal is interrupted a message will appear:

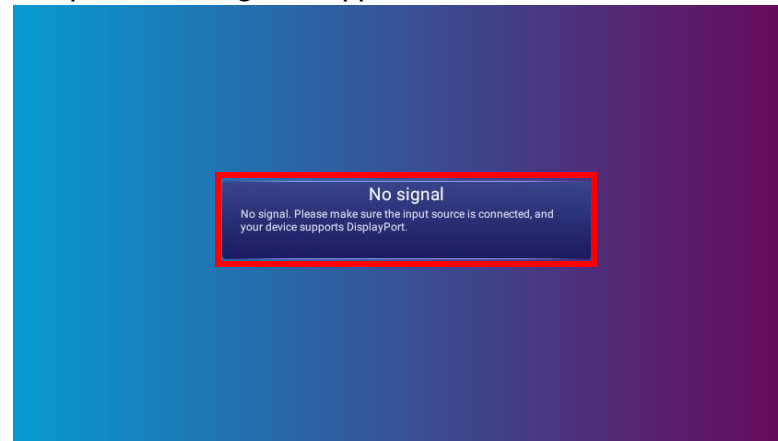

6. Press  $\rightarrow$  to stop the broadcast and return to the previously displayed menu, or press  $\square$  to exit and go back to the **BenQ Launcher** home screen directly.
7. If the device remains connected and you wish to display its signal again, navigate to the **Input Source** button on the **BenQ Launcher** home screen and press **OK**. Select the device and press **OK**.

- 
- Some computers feature HDMI ports that do not transmit audio, in such cases a separate audio cable must be connected to the projector.
  - If you want to use your USB-C™ device as a storage device to view videos, images, and audio, see [Media Player on page 71](#).
  - Many laptops do not turn on their external video ports when connected to a projector. Usually a key combination like **Fn + F3** or CRT/LCD key turns the external display on/off. Locate a function key labeled CRT/LCD or a function key with a monitor symbol on the laptop. Press **Fn** and the labeled function key simultaneously. Refer to your laptop's documentation to discover your laptop's key combination.
-

## Connecting a flash drive

Connect a USB-A or USB-C™ flash drive to the USB 2.0 or USB-C™ port on the right side of the projector to view media files stored on the flash drive.

To connect a flash drive:

1. Connect the flash drive to the USB 2.0 or USB-C™ port on the right side of the projector.
2. A pop-up notification will appear indicating that a storage device is connected to the projector. Select **OPEN** to open the device.

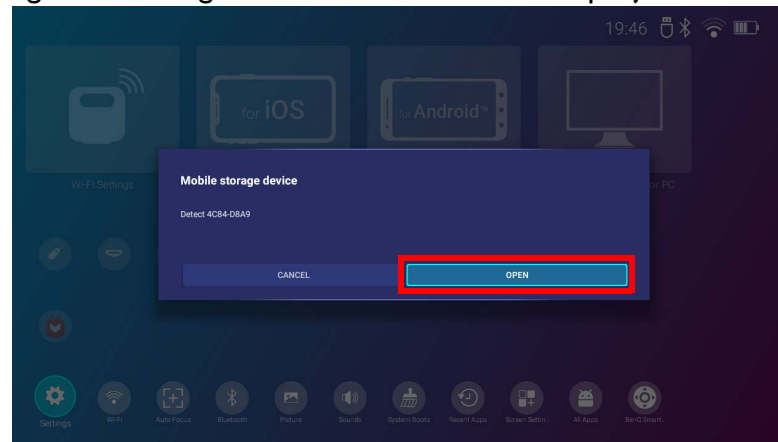

3. The **Media Player** will launch automatically. For more information on viewing files on **Media Player** see [Media Player on page 71](#).

## Media Player

The **Source** menu on the **BenQ Launcher** interface allows you to access images, videos, and audio files for projection once a USB-C™ or USB-A flash drive or mobile device without DisplayPort capabilities is connected. See [Connecting a flash drive on page 70](#) for more information on connecting such devices to the projector.

- 
- Once a storage device is connected to the projector, a notification will be displayed asking if you want to open the device. Select **OPEN** to be automatically directed to **Media Player** or select **CANCEL** to remain on the current screen.
  - See [Supported file formats on page 128](#) for a list of what file formats can be played on the projector.
- 

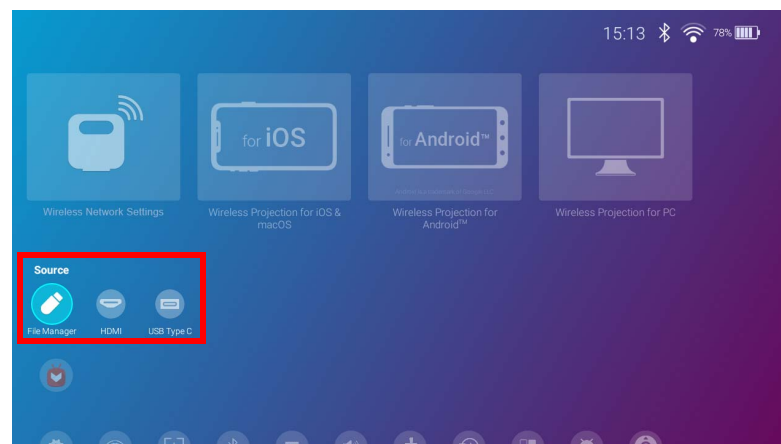

## Navigation

- Use the arrow keys (▲/▼/◀/▶) on your remote control to navigate to the file or icon you wish to select.
- Press **OK** to select a menu or file.
- Press **↶** to return to the previously displayed menu or to exit out of playing a media file.

The **Media Player** will show selections for your connected devices.

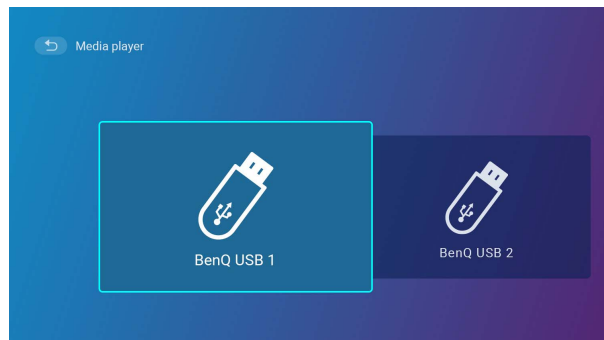

Each selection has a sub-directory that lists files for each of the following categories: **All**, **Video**, **Picture** and **Audio**.

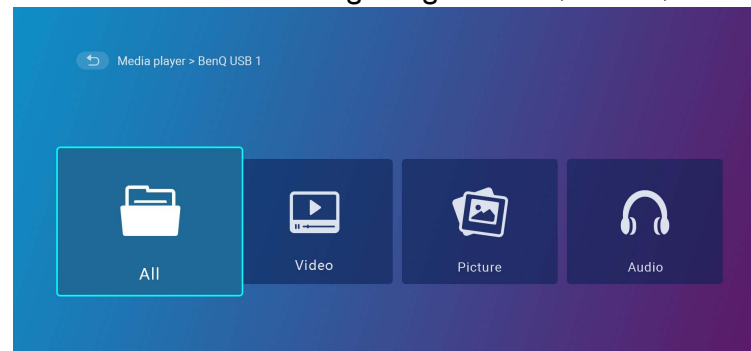

If no supported media files are on the connected device then a message "**Not Available**" will appear.



## Using the **Media Player** to play video files:

1. Select **Video** in the sub-directory list for the connected device and press **OK**.

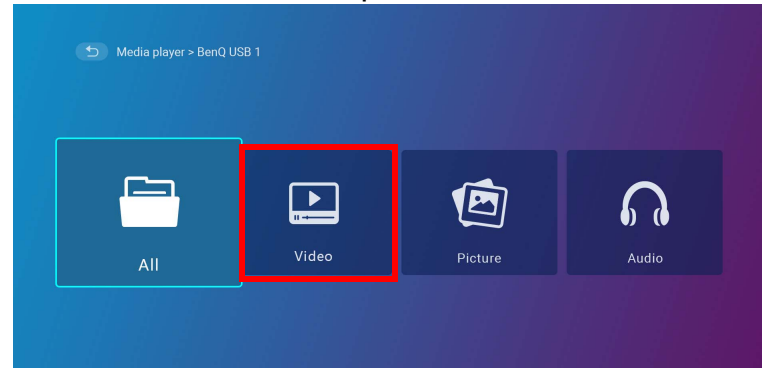

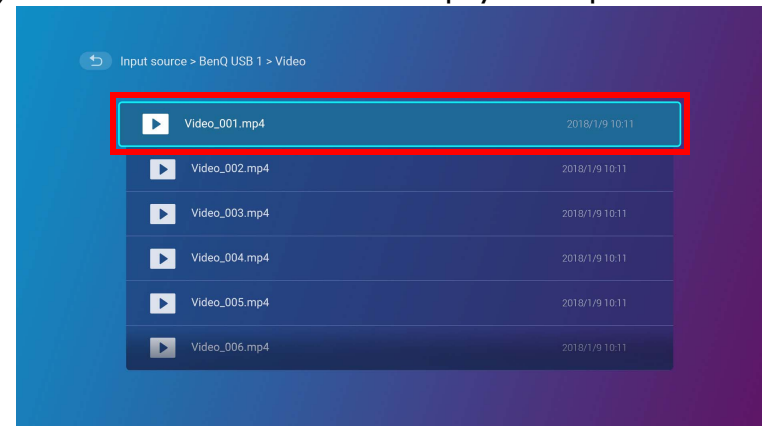

2. Use the up and down arrow keys (**▲/▼**) to choose the video file to be displayed and press **OK**.



3. The video file will begin playing.

4. In the viewing window you can choose one of the following options:

- Press the **OK** key on the  button to pause the video. Press it again to resume playing.
- Press the **OK** key on the  button to rewind the video.
- Press the **OK** key on the  button to fast forward the video.

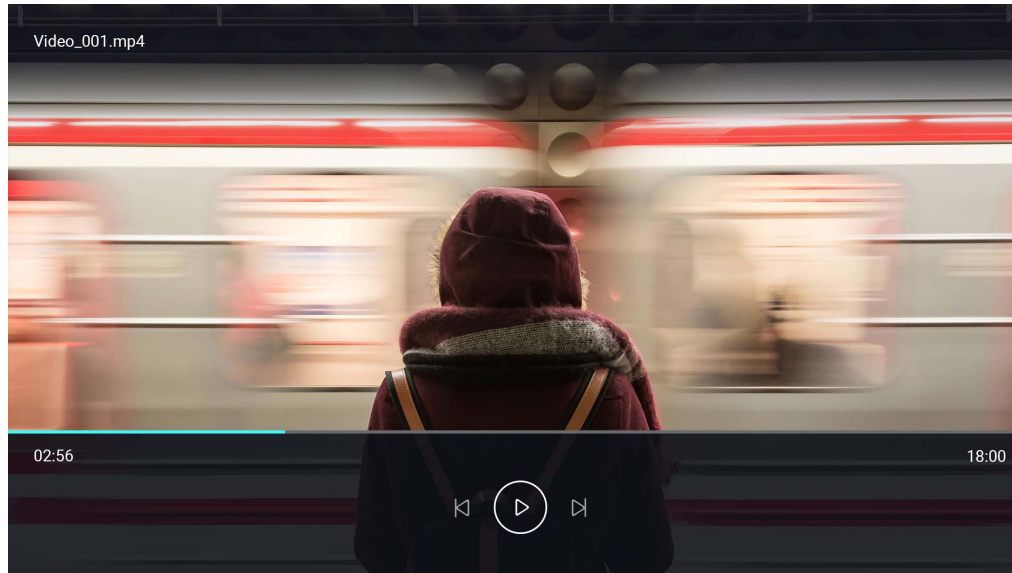

5. If the video file was played previously, a pop-up notification will appear asking to resume play or start over.

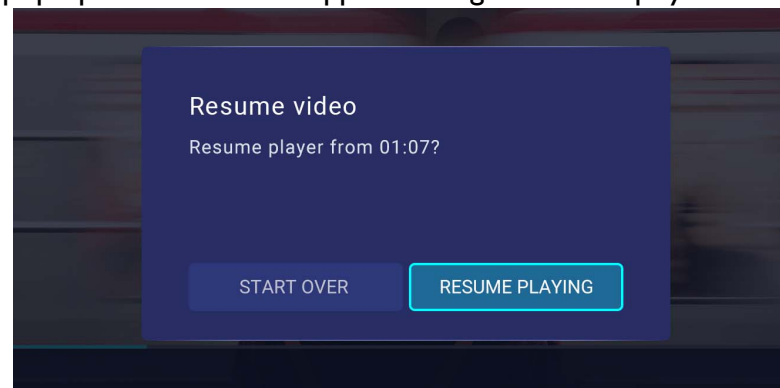

## Using the **Media Player** to play image files:

1. Select **Picture** in the sub-directory list for the connected device and press **OK**.

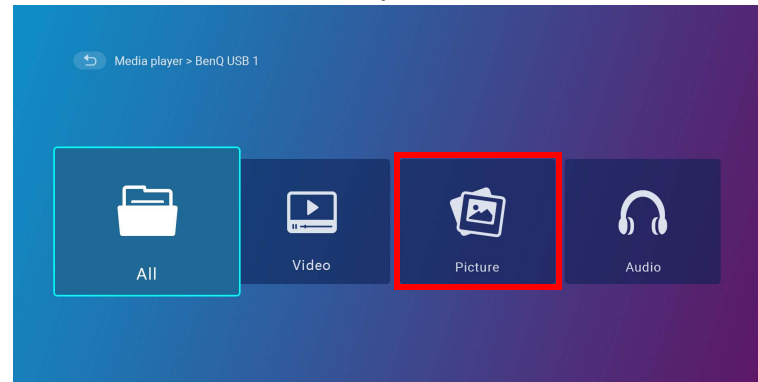

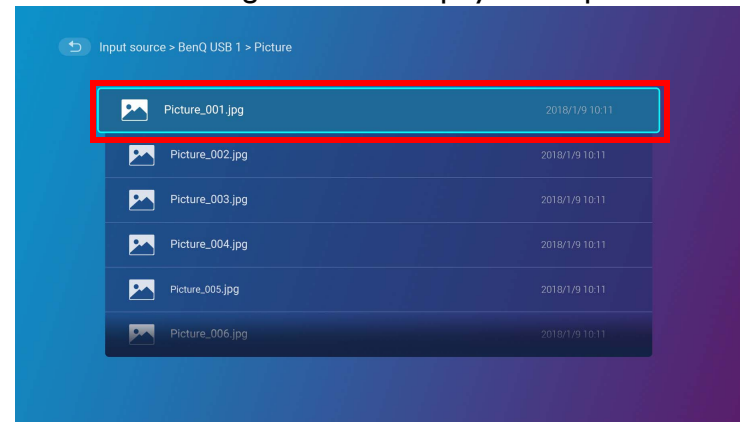

2. Use the up and down arrow keys (**▲/▼**) to choose the image file to be displayed and press **OK**.



3. The image file will be displayed.

4. In the viewing window you can choose one of the following options:

- Press the **OK** key on the  button to stop playing the playlist.
- Press the **OK** key on the  button to play the previous image in the playlist.
- Press the **OK** key on the  button to play the next image on the playlist.

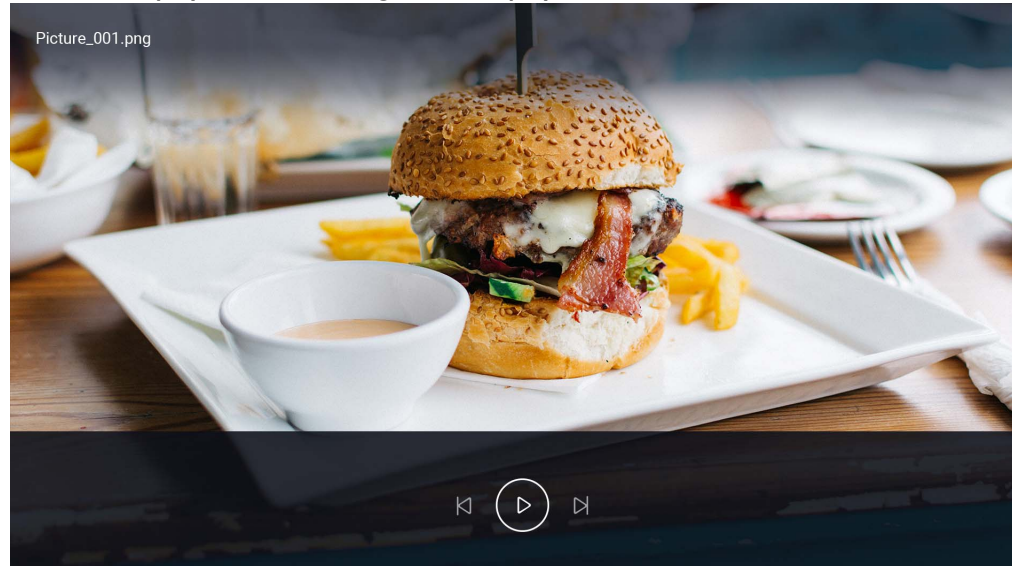

## Using the **Media Player** to play audio files:

1. Select **Audio** in the sub-directory list for the connected device and press **OK**.

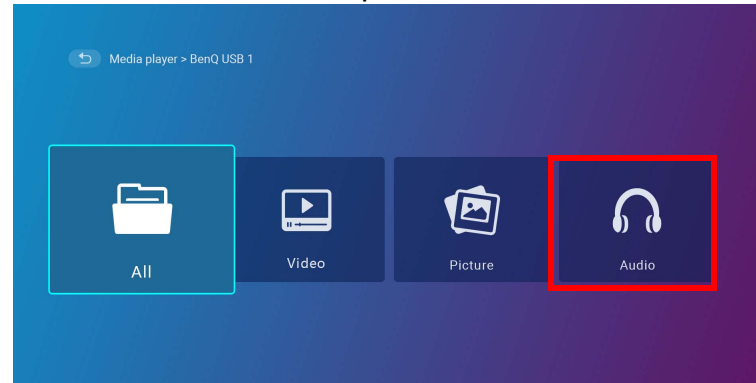



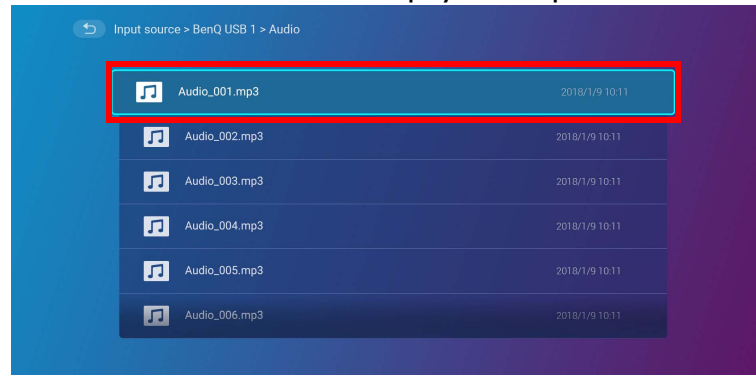





2. Use the up and down arrow keys (**▲/▼**) to choose the audio file to be played and press **OK**.





3. The audio file will begin playing.

4. In the viewing window you can choose one of the following options:

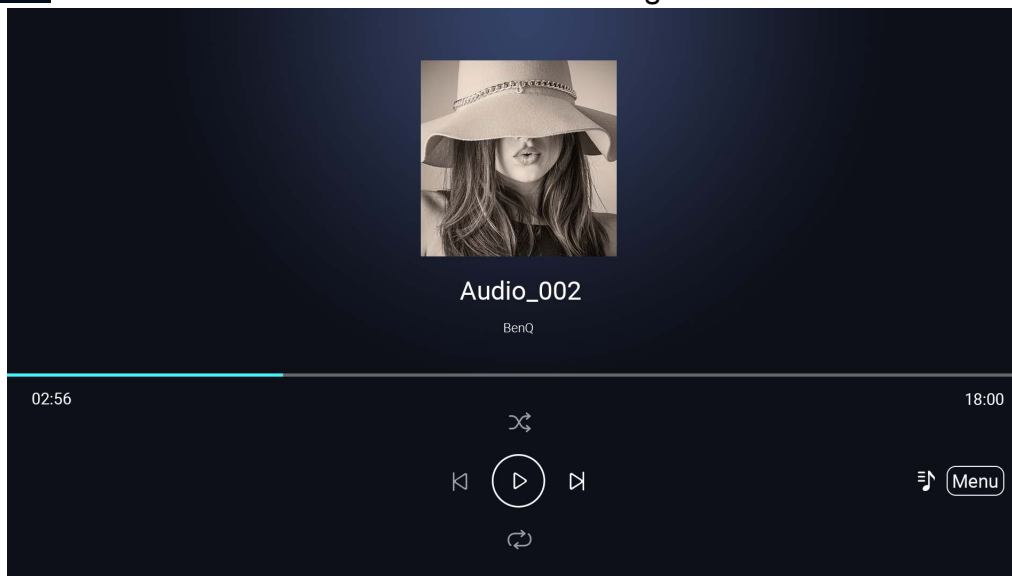
- Press the **OK** key on the  button to start or stop playing the audio file.
- Press the **OK** key on the  button to play the previous audio file in the playlist.
- Press the **OK** key on the  button to play the next audio file on the playlist.
- Press and hold the left arrow key (◀) on the  button to rewind through an audio track.
- Press and hold the right arrow key (▶) on the  button to fast forward through an audio track.
- Press the **OK** key on the  button to randomly play all audio files on the playlist. Press **OK** again to turn shuffle mode off.
- Press the **OK** key on the  button to repeat the playlist on a loop. Press the **OK** key again to repeat playing the current audio file . Press **OK** again to turn repeat mode off.
- Press the **OK** key on the  button to return to the album where the song is listed.



- You can play audio files in the background while playing an image slideshow. Select  while an audio file is playing in the audio player in order to return to the **Media Player** main menu to select an image file to play.
- The  button will only work if songs are organized in albums. If all songs are in one directory then it will have no function.

# Bluetooth Connections

The projector allows the following types of Bluetooth connections:

- Connect to a Bluetooth-enabled speaker or headphones to output audio directly for greater sound particularly in outdoor settings.
- Connect a mobile device to the projector to broadcast audio through the projector's speakers.

## Pairing/Connecting to a Bluetooth speaker or headphones

Pairing is the process by which your projector creates a connection to a Bluetooth speaker or headphones for the first time. Once both devices have been successfully paired each device will have the corresponding device's pairing information stored internally and both will be able to connect automatically when they are within an ~8 meter range of each other and Bluetooth is enabled on the projector.

To pair your projector to a Bluetooth speaker or headphones:

1. Install the provided wireless dongle into the wireless dongle port (see [Installing the wireless dongle on page 34](#)).
2. Power on the projector (see [Starting up the projector on page 37](#)).
3. Press the down arrow key ▼ and right arrow key ► on the remote control to navigate to the settings sub-menu shortcuts.
4. Select **Bluetooth** and press **OK**.

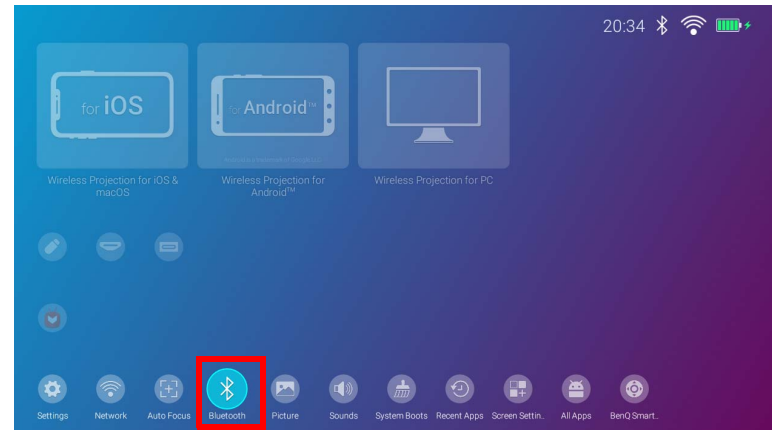

5. Select **Bluetooth** and press **OK** to enable Bluetooth.

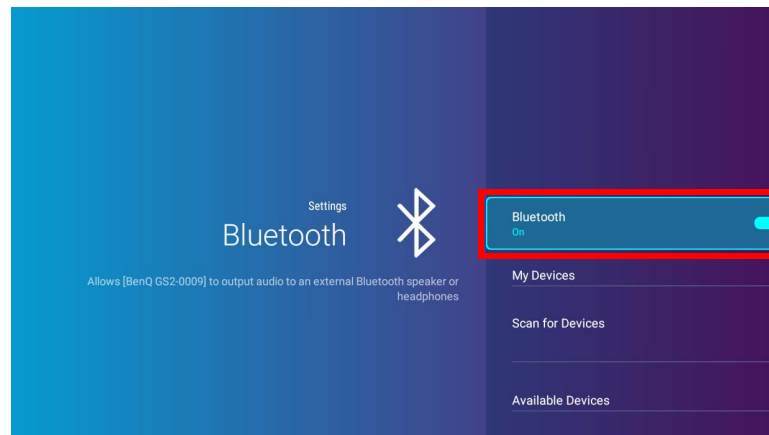

6. Activate Bluetooth-pairing mode on the speaker or headphones.

7. Select the speaker or headphones from the **Available Devices** in the **Bluetooth** setting menu and press **OK**.

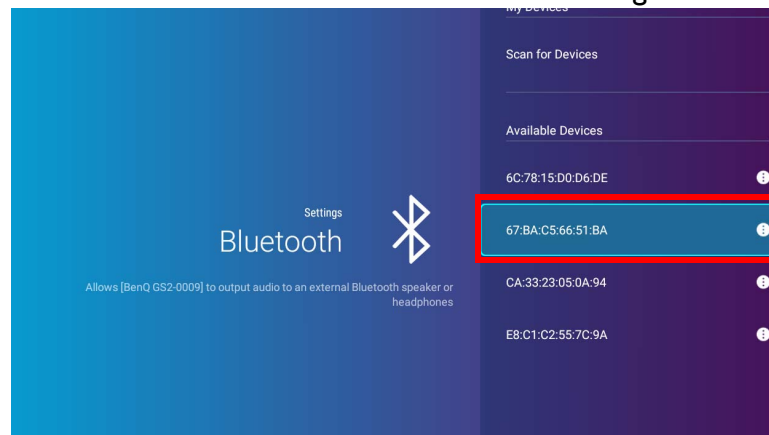

8. When the projector and speaker or headphones have successfully connected the device listing in the Bluetooth setting menu will be labeled **Connected**, you can now output the audio from the projector to the speaker or headphone.

Once you have successfully paired your projector with the Bluetooth speaker, pairing information will be stored on both devices and a connection will automatically be made when Bluetooth is enabled on both devices and both devices are within range of each other.



## Ending the Bluetooth connection

In cases where you want to disconnect a speaker or headphones from the projector and connect to another speaker or headphones follow the steps below:

1. Press the down arrow key ▼ and right arrow key ► on the remote control to navigate to the settings sub-menu shortcuts.
2. Select **Bluetooth** and press **OK**.
3. Select the already connected speaker or headphones from the **Available Devices** list in the **Bluetooth** setting menu and press **OK**.
4. Confirm that you want to disconnect the speaker or headphones from the projector.
5. Activate Bluetooth-pairing mode on the new speaker or headphones.
6. Select the new speaker or headphones from the **Available Devices** list in the **Bluetooth** setting menu and press **OK**.

## Deactivating the Bluetooth speaker or headphones

To deactivate Bluetooth on the projector so that it no longer outputs its audio to a separate speaker or headphones:

1. Press the down arrow key ▼ and right arrow key ► on the remote control to navigate to the settings sub-menu shortcuts.
2. Select **Bluetooth** and press **OK**. Select **Bluetooth** and press **OK** to disable Bluetooth.

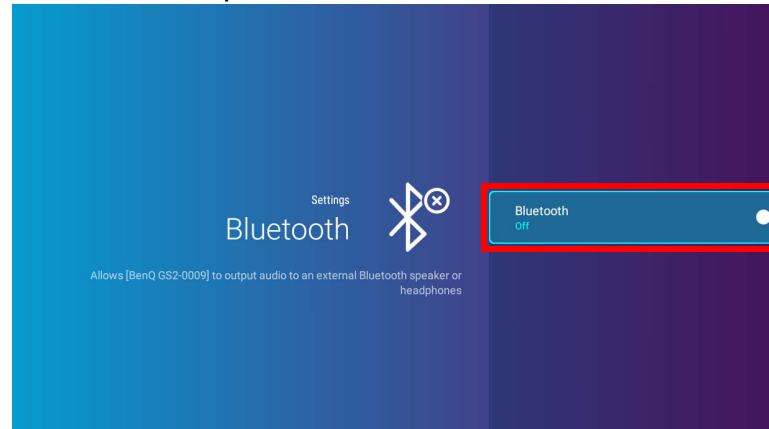

## Using the Projector as a Bluetooth speaker

1. Install the provided wireless dongle into the wireless dongle port (see [Installing the wireless dongle on page 34](#)).
2. Activate Bluetooth-pairing mode on the external device.
3. Power on the projector (see [Starting up the projector on page 37](#)).
4. Press the down arrow key ▼ on the remote control to navigate to the settings menus.
5. Select **Settings** and press **OK**.
6. Select **Bluetooth Speaker Mode** and press **OK**.

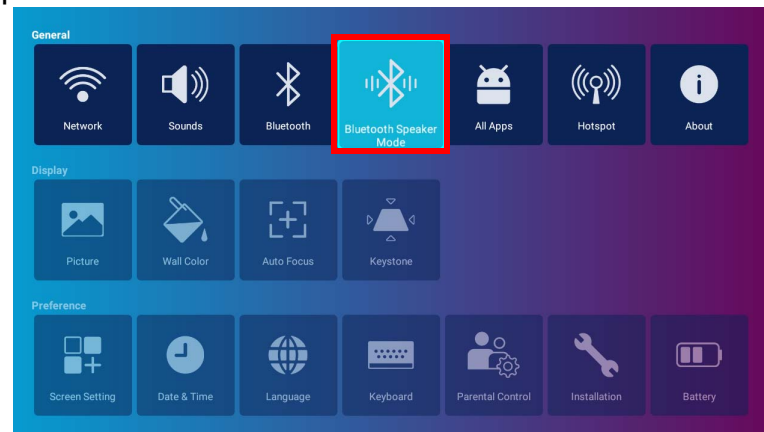

7. Select **OK** to change to speaker mode.

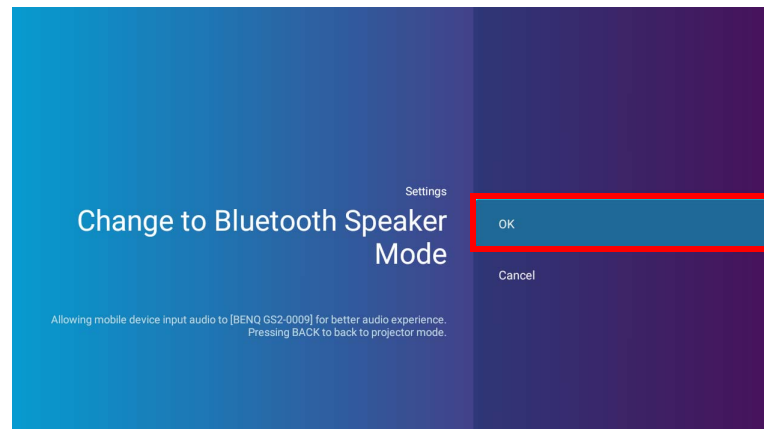

8. Select **OK** to confirm the setting.

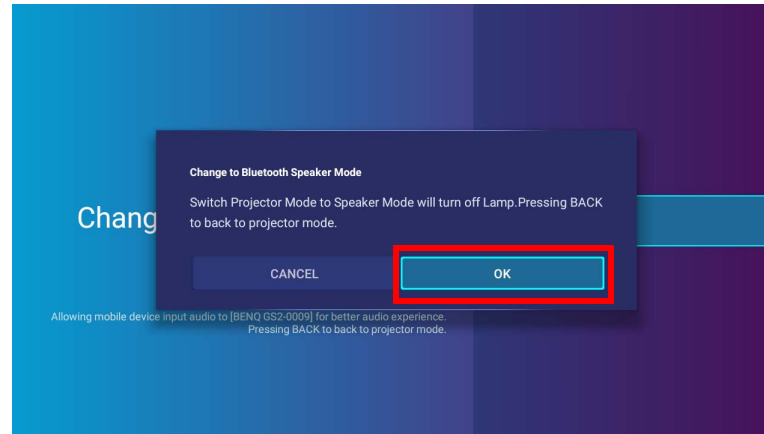

Once you have successfully paired your mobile device with the projector, pairing information will be stored on both devices and a connection will automatically be made when Bluetooth is enabled on both devices and both devices are within range of each other.

## Ending the Bluetooth connection

In cases where you want to disconnect the mobile device from the projector either:

- Disconnect from the projector in the Bluetooth menu of your mobile device.
- Press the back key  $\Rightarrow$  on the remote control to return the projector to projector mode.

# Navigating the **Settings** menu

## About the **Settings** menu

To let you make various adjustments or settings on the projector, its wireless connections, and the projected image, **BenQ Launcher** provides a **Settings** menu. Under the **Settings** menu are menus for various settings.

To access the **Settings** menu, in the **BenQ Launcher** home screen press the down button ▼ on your remote control, and then select **Settings**.

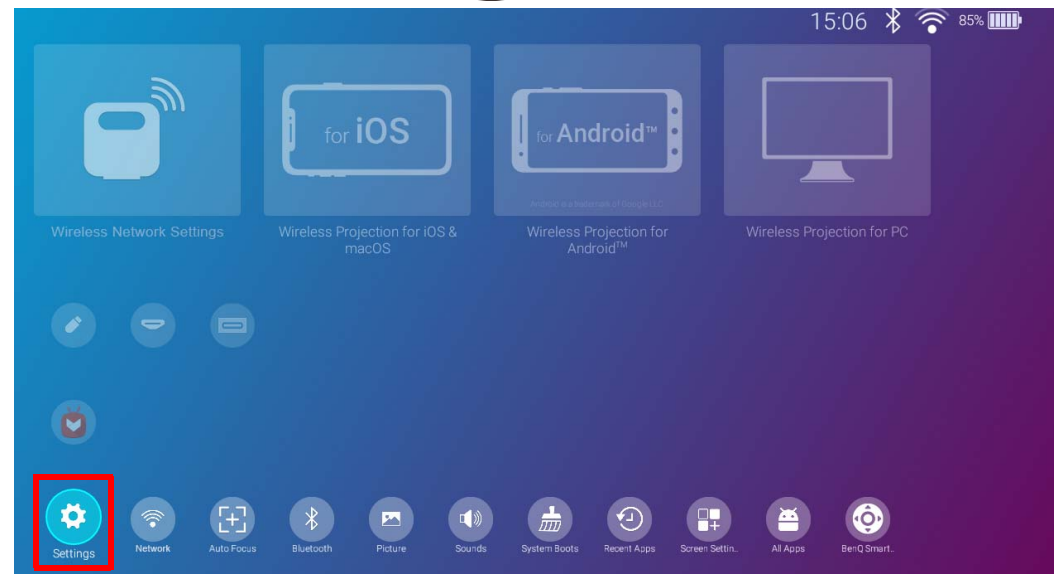
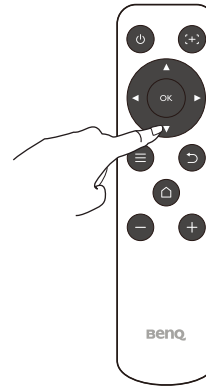

Under the settings menu there are three subcategories: **Display**, **General**, and **Preference**.

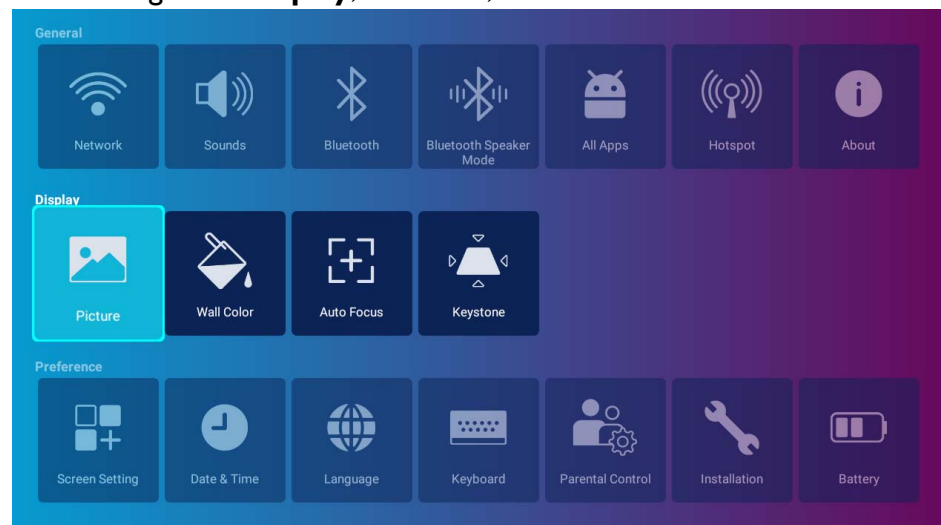

## Using the **Settings** menu

To access the various settings menus:

- Use the left and right arrow keys (◀/▶) to move through the main settings menus.
- Use **OK** to select the desired menu.

When configuring items within a menu:

- Use the up and down arrow keys (▲/▼) to move to the item you want to configure.
- Use left and right arrow keys (◀/▶) to toggle through the available options.
- Use **OK** to enable/disable options or select sub-menu options.
- Use the back button ↶ to return to the main settings menu.
- Use the home button ◻ to return to the **BenQ Launcher** home screen.

---



 If the projector is not of the latest version of firmware, a red dot will appear on the **About** icon. In such a circumstance, users can go to the **About** menu and then select **System Update > Update** to start firmware update. The red dot will disappear when the projector is updated with the latest version of firmware. See [System Update on page 112](#) for more information.

---

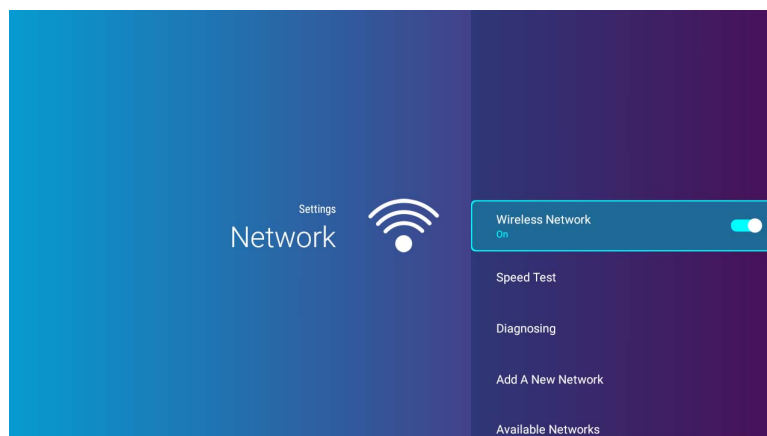
# Network



The following table describes the items available in the **Network** menu:

Item	Options and descriptions
<b>Wireless Network</b>	Enables wireless connection for the projector. See <a href="#">Connecting the projector to a wireless network on page 54</a> for details.  This function is only available when <b>Hotspot</b> is disabled.
<b>Speed Test</b>	Tests the speed of the projector's Internet connection.
<b>Diagnosing</b>	Diagnoses the status of the projector's Internet connection.
<b>Add A New Network</b>	Allows you to add a specific network that may be hidden or undetected in the <b>Available Networks</b> . Once selected you will be prompted to enter the SSID and security settings for the network.
<b>Available Networks</b>	Lists the available wireless access points which the projector can connect to. See <a href="#">Connecting the projector to a wireless network on page 54</a> for details.  The <b>Available Networks</b> is only available when <b>Wireless Network</b> is enabled.

# Sounds

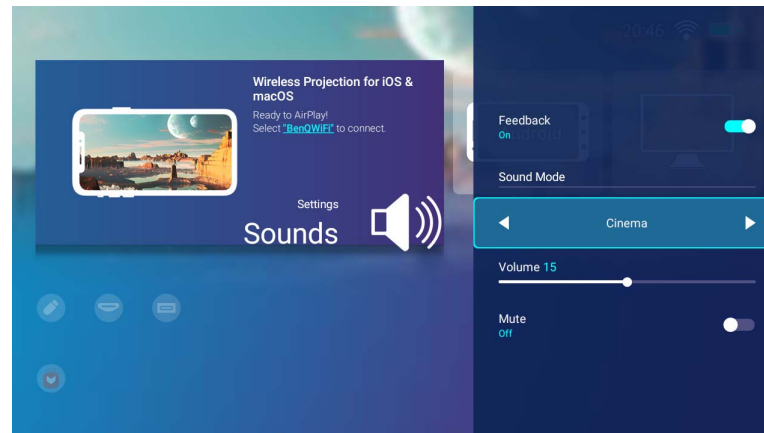



The following table describes the items available in the **Sounds** menu:

Item	Options and descriptions
<b>Feedback</b>	Enables/Disables feedback on the audio provided by the projector.
<b>Sound Mode</b>	Utilizes sound enhancement technology, which incorporates Waves' algorithms to deliver great effects of the bass and treble and provide you with immersive cinematic audio experience. The following preset sound modes are provided: <b>Standard, Cinema, and Music.</b>
<b>Volume</b>	Adjusts the sound level for the projector.
<b>Mute</b>	Sets projector audio between on and off.

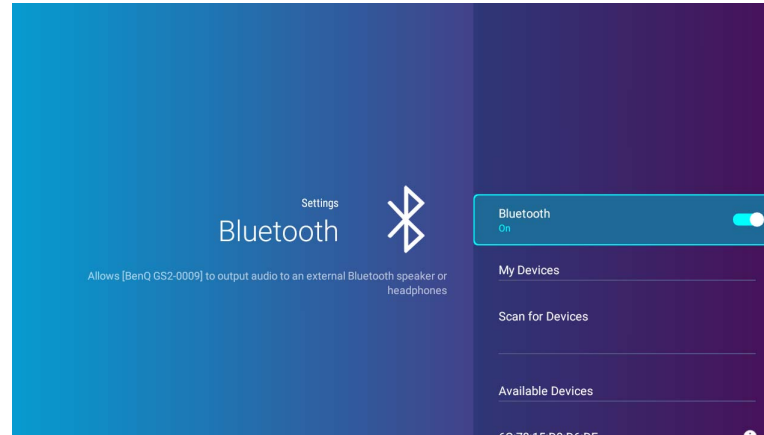
# Bluetooth



The following table describes the items available in the **Bluetooth** menu:

Item	Options and descriptions
<b>Bluetooth</b>	Enables Bluetooth for the projector, allowing the projector to output its audio to a Bluetooth speaker or headphones.
<b>My Devices</b>	<p data-bbox="398 866 1456 906">Lists the available Bluetooth devices which the projector can pair and connect to.</p> <p data-bbox="407 922 1093 986">  This function is only available when <b>Bluetooth</b> is enabled.         </p>
<b>Scan for Devices</b>	<p data-bbox="398 1008 772 1048">Refreshes the list of devices.</p> <p data-bbox="407 1064 1093 1128">  This function is only available when <b>Bluetooth</b> is enabled.         </p>
<b>Available Devices</b>	<p data-bbox="398 1150 1993 1225">Lists the available Bluetooth devices which the projector can connect to. See <a href="#">Pairing/Connecting to a Bluetooth speaker or headphones on page 79</a> for details.</p> <p data-bbox="407 1241 1220 1305">  The <b>Available Devices</b> is only available when <b>Bluetooth</b> is enabled.         </p>



## Bluetooth Speaker Mode

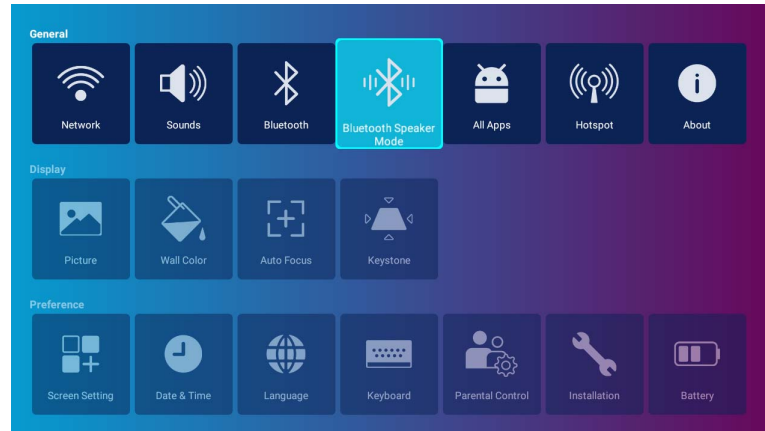

Select **OK** to enable the Bluetooth speaker mode. See [Using the Projector as a Bluetooth speaker on page 82](#) for more details.

## All Apps

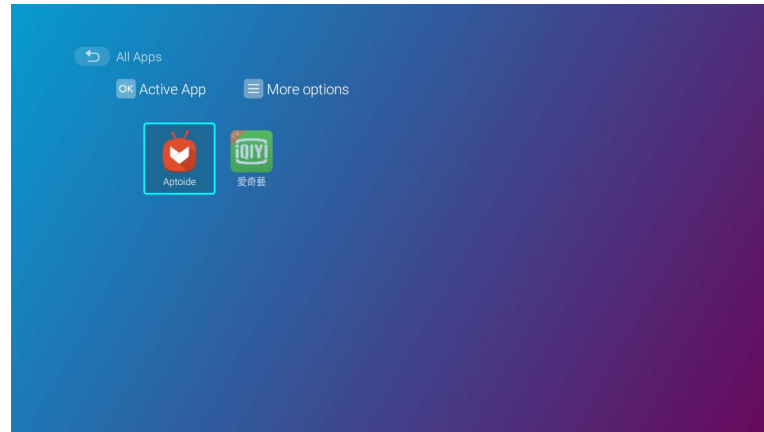



Select the **All Apps** menu to access all the apps that have been installed on the projector.

- Select an app and press **OK** on the remote control to launch the app.
- Select an app and press the menu button ( $\equiv$ ) on the remote control to uninstall the app.

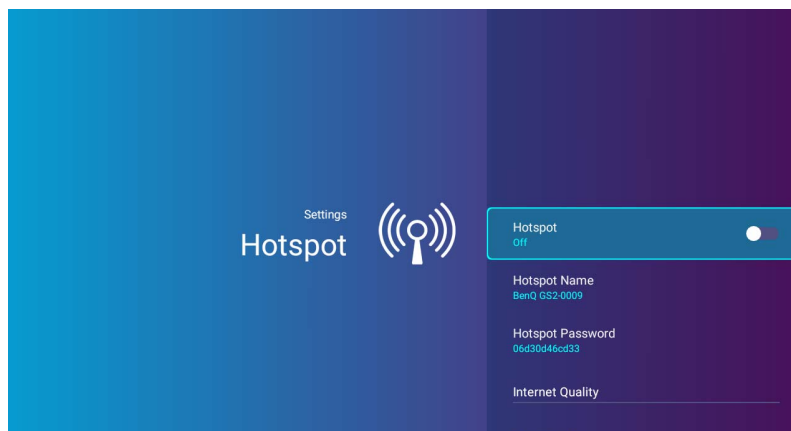
# Hotspot



The following table describes the items available in the **Hotspot** menu:

Item	Options and descriptions
<b>Hotspot</b>	Enables wireless hotspot for the projector, allowing other devices to connect to the projector directly. See <a href="#">wireless Hotspot on page 63</a> for details.
<b>Hotspot Name</b>	Sets the name for the projector's wireless hotspot, which appears in the wireless network list for devices looking to connect directly to the projector.  The default name for the projector's wireless hotspot is " <b>BenQ GS2-xxxx</b> ". The final four digits are the last four digits of its Mac Address.
<b>Hotspot Password</b>	Sets the password for the projector's wireless hotspot.  The password needs to be 8~16 characters.
<b>Internet Quality</b>	Sets the frequency for the projector's wireless hotspot signal. Available options include <b>Better (5G)</b> and <b>Normal (2.4G)</b> .  Certain mobile devices may not be able to connect to network via a <b>Better (5G)</b> . In such instances set the <b>Internet Quality</b> to <b>Normal (2.4G)</b> .

# About

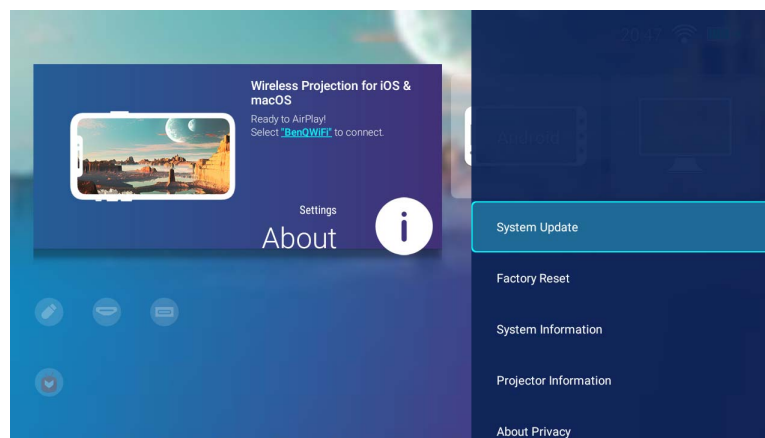

The following table describes the items available in the **About** menu:

Item	Options and descriptions
<b>System Update</b>	Displays the firmware version and ways to update the software. Select <b>Update</b> to update the software over wireless network.  Do not select <b>USB Update</b> as it is for service use only.
<b>Factory Reset</b>	Returns all settings to the factory preset values.
<b>System Information</b>	Displays hardware/software information for the projector including its device name, operating system version, memory, storage capacity, serial number, and MAC address.
<b>Projector Information</b>	Displays information on the current status of the projector including the current <b>Source, Picture Mode, Wall Color, Resolution, Color System, Light Usage Time, and Firmware Version.</b>
<b>About Privacy</b>	Displays the BenQ privacy announcement.

 A red dot at the top right of the **About** icon indicates that a newer version of the projector's firmware is available. In such circumstances, users can select **System Update > Update** to start the firmware update. The red dot will disappear once the projector is updated with the latest version of firmware. See [System Update on page 112](#) for more information.

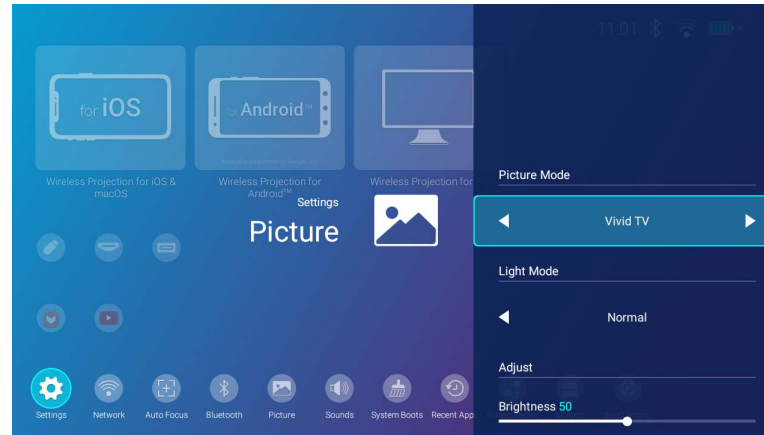

# Picture



The following table describes the items available in the **Picture** menu:

Item	Options and descriptions	
<b>Picture Mode</b>	Selects a preset picture mode to suit your operating environment and input signal picture type. The preset picture modes are described as below:	
	<b>Bright</b>	Maximizes the brightness of the projected image. This mode is suitable for environments where extra-high brightness is required, such as using the projector in well lit rooms.
	<b>Vivid TV</b>	Being slightly brighter than <b>Cinema</b> mode, it is suitable for playing movies in rooms where there is a small amount of ambient light, e.g. your living room.
	<b>Cinema</b>	Well-balanced color saturation and contrast with a low brightness level, this mode is most suitable for enjoying movies in a totally dark environment (as you would find in a commercial cinema).
	<b>Sport</b>	This mode is best for watching sporting events in rooms where is a small amount of ambient light, eg. your living room.
	<b>Camp Fire</b>	Being slightly brighter than <b>Cinema</b> mode, it is suitable for playing movies in the outdoors where there is a small amount of ambient light at night.

Item	Options and descriptions	
	<b>Bed Time</b>	Well-balanced color saturation and contrast, slightly darker than <b>Cinema</b> mode, this mode is designed for creating a comfortable mood similar to a warm-toned night lamp.
	<b>User</b>	Recalls the customized settings.
<b>Light Mode</b>	Selects the projector lamp power from the following modes:	
	<b>Normal</b>	Provides full lamp brightness.
	<b>Eco Mode</b>	Reduces system noise and power consumption by 30%. If <b>Eco Mode</b> is selected, the light output will be reduced and result in darker projected pictures.
	<b>Battery Mode</b>	Reduces system noise and power consumption to fulfill 3 hours projection*. If <b>Battery Mode</b> is selected, the light output will be reduced and result in darker projected pictures. *The 3 hours of projection is under the following testing conditions: <ul style="list-style-type: none"> <li>• <b>Light Mode: Battery Mode</b></li> <li>• <b>Picture Mode: Vivid TV mode</b></li> <li>• Audio volume: 50% and playing from GS2</li> <li>• <b>Bluetooth: On</b>, but not connected to other device</li> <li>• <b>Wireless Network: On</b> and connected</li> </ul>
<b>Brightness</b>	The higher the value, the greater the brightness. Use this to set the peak white level to suit your selected input and viewing environment.	
<b>Color</b>	Adjusts the color saturation level — the amount of each color in a video picture. Lower settings produce less saturated colors; setting to the minimum value makes the image black and white. If the image setting is too high, colors on the image will be overpowering, which makes the image unrealistic.   <b>Color</b> settings can only be adjusted when HDMI, USB flash drive, or DisplayPort is selected as the source.	
<b>Sharpness</b>	Adjusts the sharpness of the image — the distinctness of the boundaries between different tones or colors. The higher the value the sharper the image, while the lower the value the less sharp the image is.	

Item	Options and descriptions	
<b>Color Temperature</b>	The options available for <b>Color Temperature</b> settings vary according to the connected input signal.	
	 There are many different shades that are considered to be “white” for various purposes. One of the common methods of representing white color is known as the “color temperature”. A white color with a low color temperature appears to be reddish white. A white color with a high color temperature appears to have more blue in it.	
	<b>Normal</b>	Maintains the normal colorings for white.
	<b>Warm</b>	Makes images appear bluish white.
<b>Cool</b>	Makes images appear reddish white.	
<b>LumiExpert</b>	Adjusts the Gamma level automatically based on the ambient light detected through the ambient light sensor (ALS).	
	<b>LumiExpert</b>	Selects to turn <b>On</b> or <b>Off</b> the <b>LumiExpert</b> .
	<b>Level</b>	Adjusts the <b>Level</b> from -1 (dark) to 1 (bright).  This function is only available when <b>LumiExpert</b> is enabled.
<b>Reset Picture Setting</b>	Resets all <b>Picture</b> settings to factory preset values.	

# Wall Color

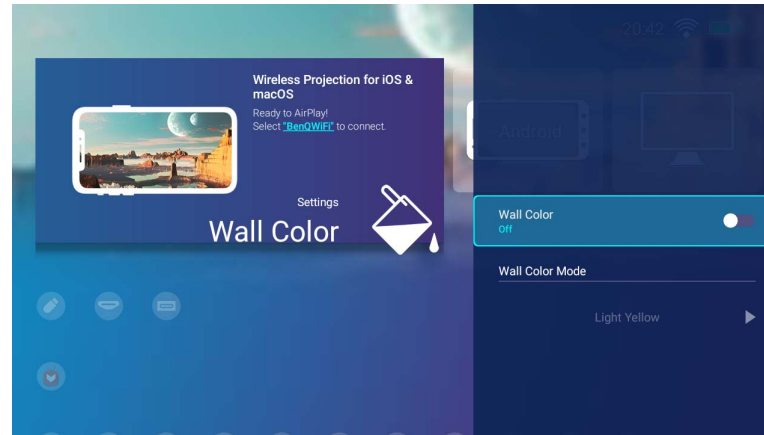

The following table describes the items available in the **Wall color** menu:

Item	Options and descriptions
<b>Wall Color</b>	Adjust the color settings of the image to suit the color of the wall on which the image is projected.
<b>Wall Color Mode</b>	Selects a wall color among <b>Light Yellow</b> , <b>Pink</b> , and <b>Blue</b> .  This function is only available when <b>Wall Color</b> is enabled.



# Auto Focus

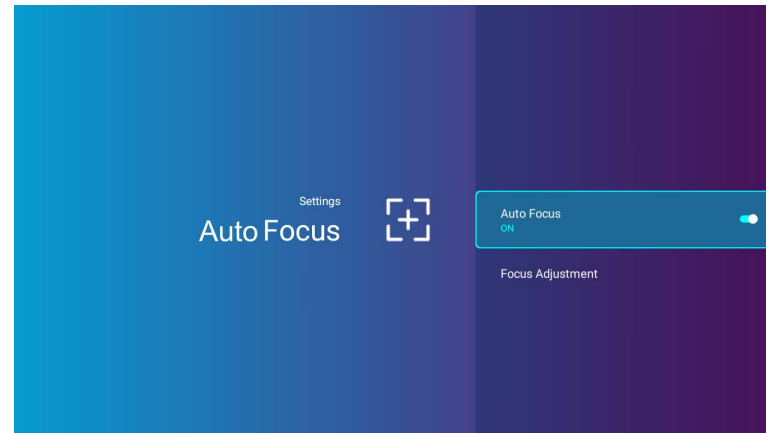

The following table describes the items available in the **Auto Focus** menu:

Item	Options and descriptions
<b>Auto Focus</b>	Enable this function to allow the projector to automatically adjust the sharpness settings when powered on.
<b>Focus Adjustment</b>	Manually adjusts the focus settings for the projected image by the use of left ◀ and right ▶ keys on your remote control.

# Keystone

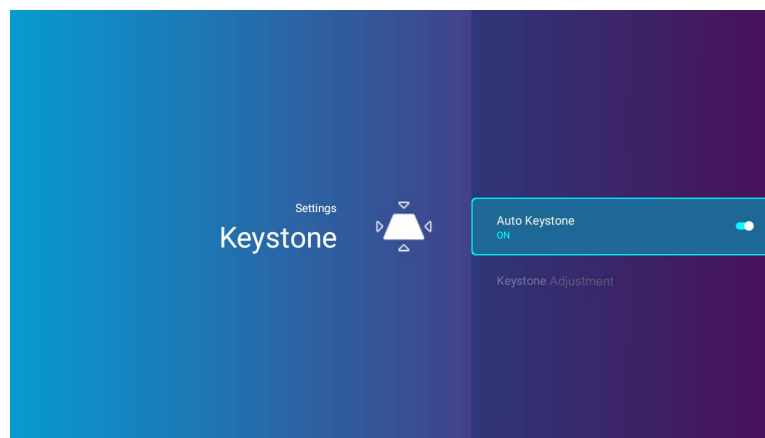

The following table describes the items available in the **Keystone** menu:

Item	Options and descriptions
<b>Auto Keystone</b>	Enable this function to allow the projector to automatically adjust the keystone settings when powered on. See <a href="#">Correcting keystone on page 45</a> for more details.
<b>Keystone Adjustment</b>	Manually adjusts the keystone settings for the projected image. See <a href="#">Correcting keystone on page 45</a> for more details.  This function is only available when <b>Auto Keystone</b> is disabled.

# Screen Settings

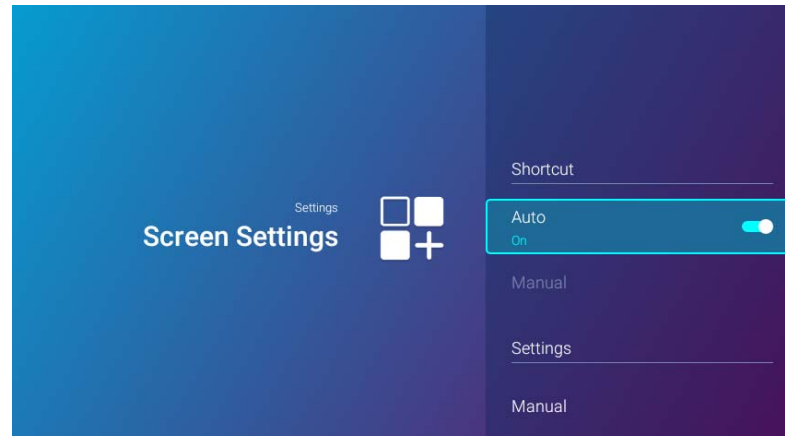

The following table describes the items available in the **Screen Settings** menu:

Item	Options and descriptions	
<b>Shortcut</b>	Sets which app shortcuts to be displayed on the <b>BenQ Launcher</b> home screen and their sequence. The home screen requires at least one shortcut and allows up to ten shortcuts.	
	<b>Auto</b>	Enables the projector to automatically arrange the sequence of app shortcuts on the home screen so that the most recently used app will appear first in the row.  <b>Aptoide</b> is by default the first shortcut in <b>Auto</b> mode. Other shortcuts line up after <b>Aptoide</b> based on the sequence that they have been used.
	<b>Manual</b>	Enables the user to manually arrange which app shortcuts to be displayed on the home screen and their sequence. Press <b>OK</b> to check (show) or uncheck (hide) the shortcuts. The app that is selected first will appear as the first in the row.

Item	Options and descriptions	
<b>Settings</b>	Sets which settings menu shortcuts to be displayed on the <b>BenQ Launcher</b> home screen and their sequence. The home screen requires at least one shortcut and allows up to eight shortcuts.	
	<b>Manual</b>	Enables the user to manually arrange which settings menu shortcuts to be displayed on the home screen and their sequence. Press <b>OK</b> to check (show) or uncheck (hide) the shortcuts. The settings menu that is selected first will appear as the first in the line.

# Date & Time

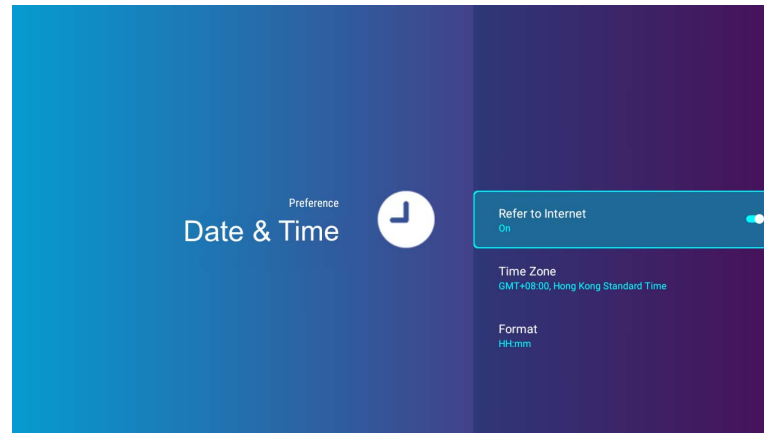

The following table describes the items available in the **Date & Time** menu:

Item	Options and descriptions
<b>Refer to Internet</b>	Sets the projector's date and time using the Internet.
<b>Time Zone</b>	Sets the time zone for the projector.
<b>Format</b>	Sets the date and time format as either <b>HH:MM</b> or <b>YYYY/MM/DD HH:MM</b> .

# Language

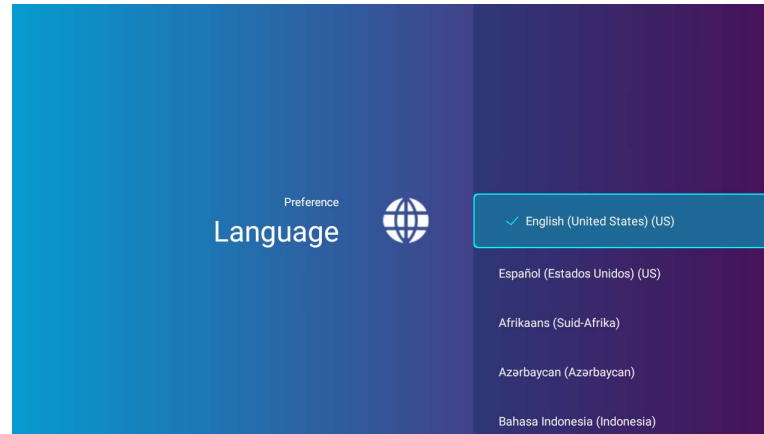

Sets the language for **BenQ Launcher**.

# Keyboard

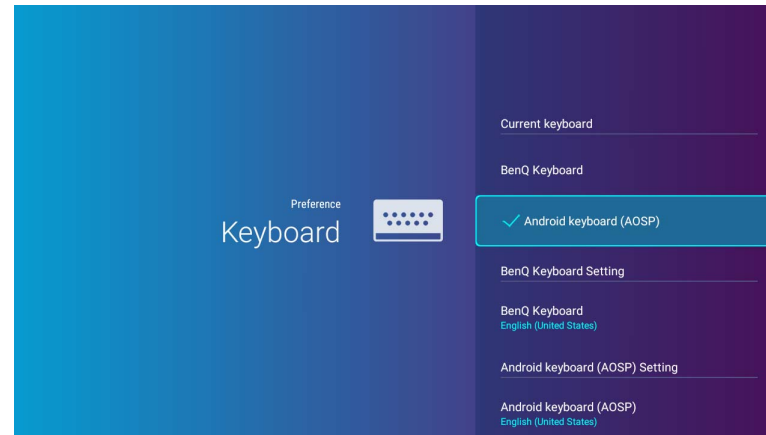



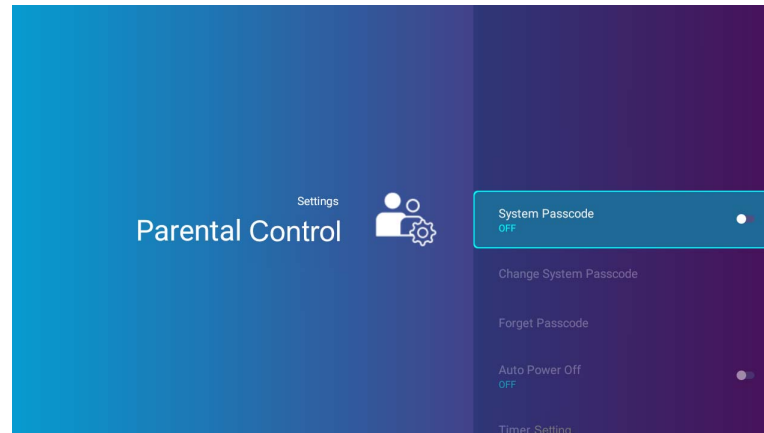

The following table describes the items available in the **Keyboard** menu:

Item	Options and descriptions
<b>Current Keyboard</b>	Displays current keyboard information as either <b>AOSP</b> or <b>BenQ Keyboard</b>
<b>Keyboard Settings</b>	Sets the projector's virtual keyboard for inputting text.  To input Chinese characters, set the language preference to traditional Chinese or simplified Chinese, and set the keyboard to <b>BenQ Keyboard</b> .



# Parental Control



The following table describes the items available in the **Parental Control** menu:

Item	Options and descriptions
<b>System Passcode</b>	Enable/Disable a <b>System Passcode</b> to configure the <b>Auto Power Off</b> and <b>Key Lock</b> settings.  The passcode needs to be 8 characters.
<b>Change System Passcode</b>	Changes the <b>System Passcode</b> .  This function is only available when <b>System Passcode</b> is enabled.
<b>Forget Passcode</b>	Scan the QR code to recover the <b>System Passcode</b> .  This function is only available when <b>System Passcode</b> is enabled.
<b>Auto Power Off</b>	Enable/Disable the auto power off timer to configure the <b>Timer Setting</b> .  This function in only available when <b>System Passcode</b> is enabled.



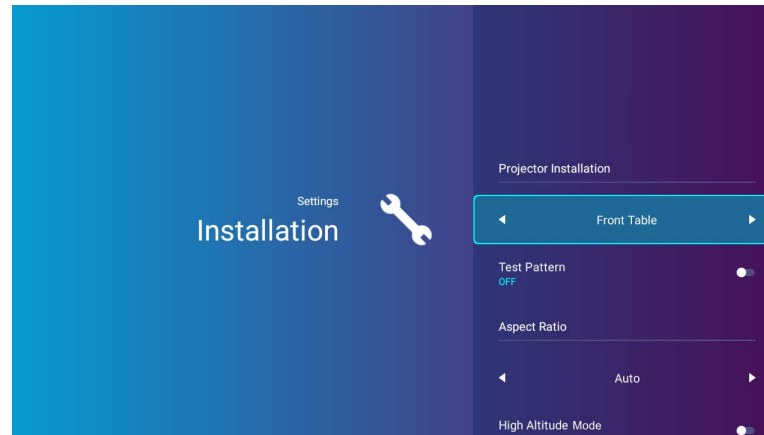

Item	Options and descriptions
<b>Timer Setting</b>	<p>Sets the time interval in which the projector will automatically power off when inactive. The timer is set up in the format of <b>HH:MM</b> and should be at least 5 minutes long.</p> <p> This function is only available when <b>Auto Power Off</b> is enabled.</p>
<b>Key Lock</b>	<p>Enables <b>Key Lock</b> which locks the control keys on the projector and prevents your projector settings from being changed accidentally (for example, by children).</p> <p>When you select <b>On</b> to enable this function, no control keys on the projector will function, except the power button. To unlock the keys, press and hold the menu button (≡) on the projector for 3 seconds.</p> <p> This function is only available when <b>System Passcode</b> is enabled.</p>
<b>Eye Protection</b>	<p>Enables/Disables the auto light shut off sensors that automatically turns off the LED light source when an object is detected within a distance of 30 centimeters (11.8 inches) in front of the projector for more than 1 second.</p>

# Installation



The following table describes the items available in the **Installation** menu:

Item	Options and descriptions	
<b>Projector Installation</b>	The projector can be installed in a high location or behind a screen. See <a href="#">Choosing a location on page 29</a> for details.	
	<b>Front Table</b>	Select this location with the projector placed near the floor in front of the screen.
	<b>Front Ceiling</b>	Select this location with the projector elevated near the ceiling in front of the screen.
	<b>Rear Table</b>	Select this location with the projector placed near the floor behind the screen.
	<b>Rear Ceiling</b>	Select this location with the projector elevated from the ceiling behind the screen.
<b>Test Pattern</b>	Enable this function to display the grid test pattern, which helps you adjust the image size and focus so as to check if the projected image is free of distortion.	

Item	Options and descriptions	
<b>Aspect Ratio</b>	<p>The native display resolution of this projector is in a 16:9 aspect ratio. However you may use this function to display projected pictures in a different aspect ratio.</p> <p> <b>Aspect Ratio</b> settings can only be adjusted when HDMI is selected as the source.</p>	
	<b>Auto</b>	Scales a picture proportionally to fit the projector's native resolution in its horizontal and vertical width. This makes the most use of the screen and maintains the aspect ratio of a picture.
	<b>Real</b>	<p>Projects the input image without scaling. The projected image will be centered. If the input image is smaller than the native resolution of the projector, the area outside of the projection area will be black. If the input image is larger than the native resolution of the projector, the outer edges of the image will be cropped.</p> <p> A PC input source with 720x400 resolution does not support real aspect ratio.</p>
	<b>4:3</b>	Scales a picture so that it is displayed in the center of the screen with a 4:3 aspect ratio.
	<b>16:9</b>	Scales a picture so that it is displayed in the center of the screen with a 16:9 aspect ratio.
<b>High Altitude Mode</b>	<p>We recommend you use the <b>High Altitude Mode</b> when your environment is between 1500 m - 2000 m above sea level, and ambient temperature is between 0°C to 30°C.</p> <p>Operation under <b>High Altitude Mode</b> may cause a higher decibel operating noise level because of increased fan speed necessary to improve overall system cooling and performance.</p> <p>If you use this projector under other extreme conditions excluding the above, it may display auto shut-down symptoms, which is designed to protect your projector from over-heating. In cases like this, you should switch to <b>High Altitude Mode</b> to solve these symptoms. However, this is not to state that this projector can operate under any and all harsh or extreme conditions.</p> <p> Do not use the <b>High Altitude Mode</b> if your altitude is between 0 m and 1500 m and ambient temperature is between 0°C to 35°C. The projector will be over cooled, if you turn the mode on under such a condition.</p>	

# Battery

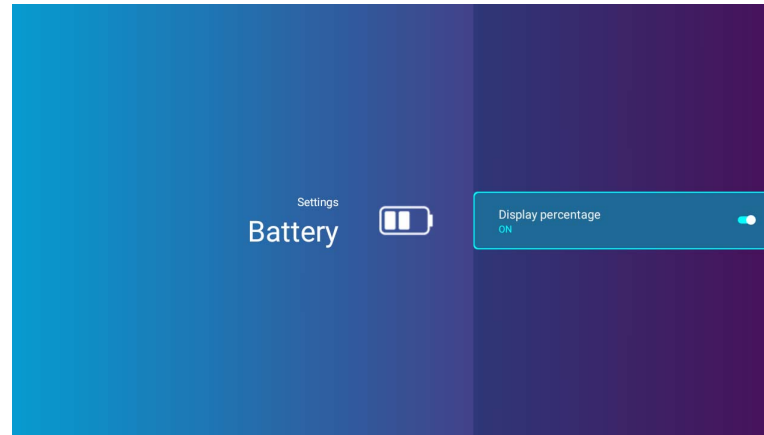

Shows or hides the battery charge icon on the **BenQ Launcher** home screen.

---

 Different **Picture Mode** and **Light Mode** settings will change battery power consumption speed.

---

## Other settings menu

The other settings menu are available in the settings menu on the front page.

### System Boots

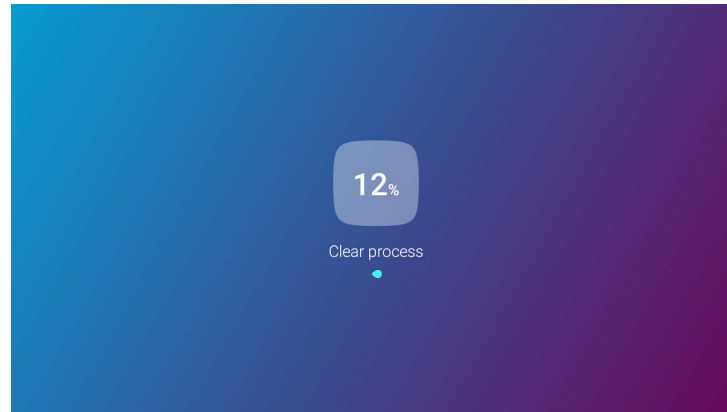

Clears out the memory of unnecessary files and boosts available RAM.

## Recent Apps

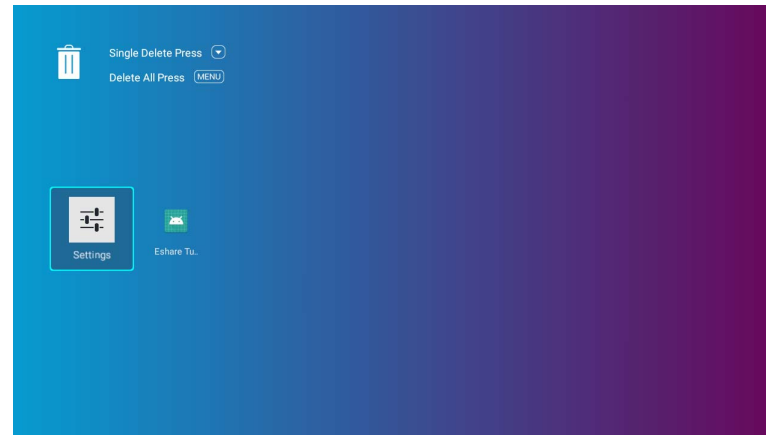

Select the **Recent Apps** menu to access a list of apps that have been recently used.

- Select any icon and press the down button (▼) on the remote control to remove the icon from the list of recently used apps.
- Select any icon and press the menu button (≡) on the remote control to clear all icons from the list of recently used apps.

# BenQ Smart Control

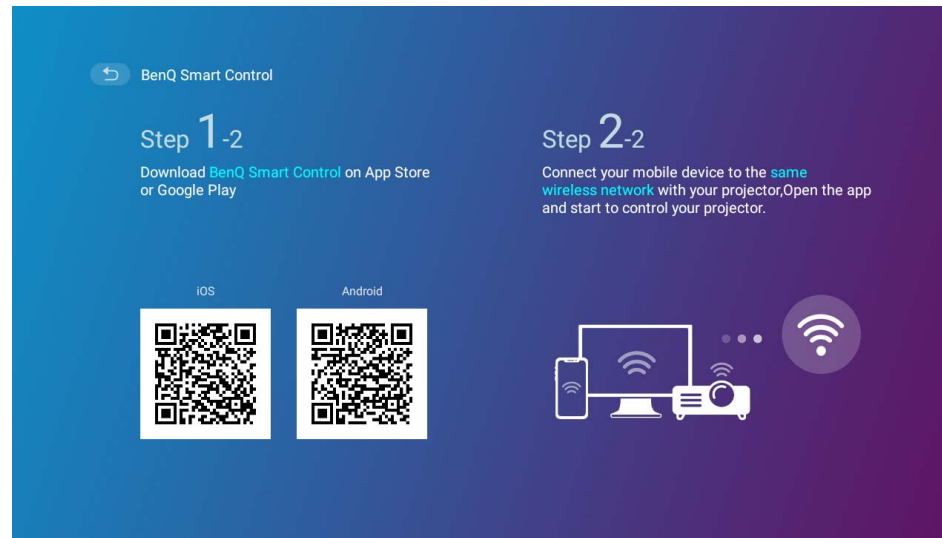

Displays the QR codes for downloading **BenQ Smart Control** app which allows you to control the projector remotely with a smart phone. See [BenQ Smart Control \(remote control app\) on page 24](#) for more information.

# System Update

It is suggested that users regularly update their projector with the latest version of the firmware to optimize the user experience. The projector uses Over-the-Air (OTA) updates to install the update file wirelessly.

When a new version is available on the BenQ OTA server, a message will pop up once the projector is connected to a wireless network. Follow the steps below to begin updating the firmware:

- I. Select **DOWNLOAD** to download the update file.

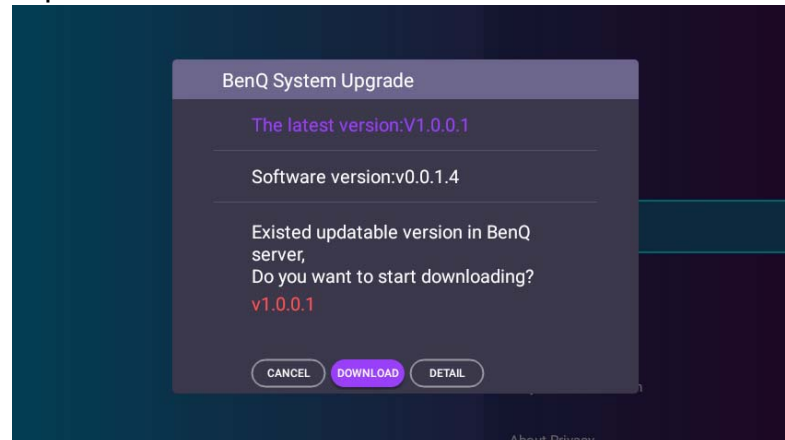



2. Once the download is completed, the projector will restart automatically. Do not turn off or unplug the projector before the projector is finished updating and **BenQ Launcher** reappears on the screen.

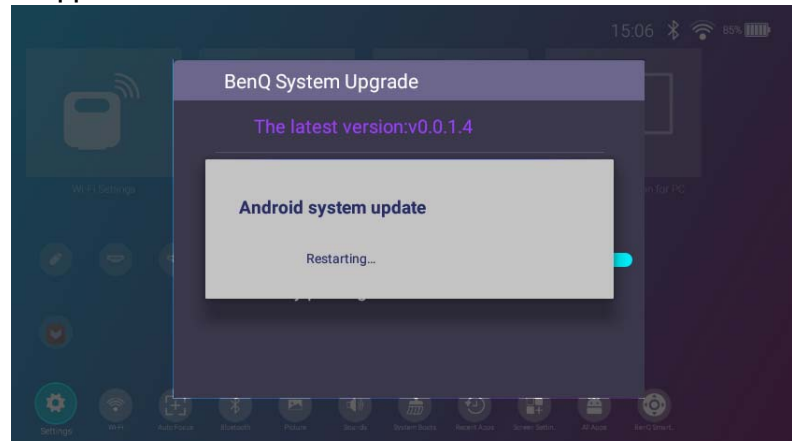

 Keep the battery charged to at least 60% (3 bars on the battery status icon) to ensure a successful OTA update.

If you select **CANCEL** when the system upgrade message appears, a red dot will appear at the top right of the **Settings > About** menu, as a reminder that a newer version of firmware is available on the BenQ OTA server. Users can use the **System Update > Update** function in the **Settings > About** menu to upgrade the system at any time.

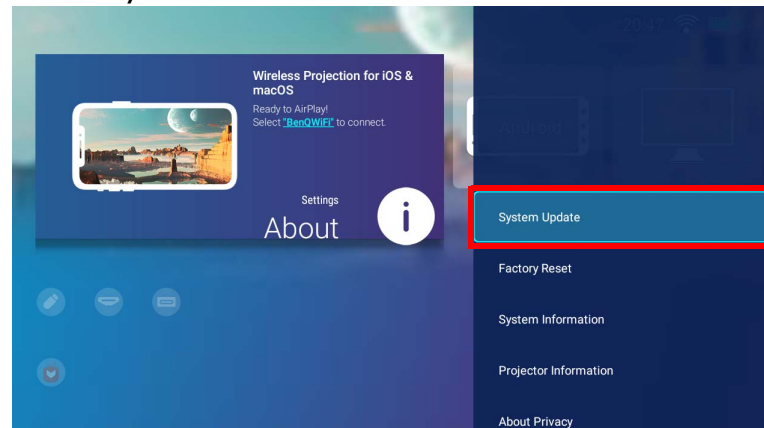

# Maintenance

## Care of the projector

Your projector needs little maintenance. The only thing you have to do on a regular basis is keep the lens clean.

Never remove any parts of the projector. Contact your dealer or local customer service center if the projector fails to operate as expected.

## Cleaning the lens

Clean the lens whenever you notice dirt or dust on the surface.

Before cleaning any part of the projector, turn it off using the proper shutdown procedure (see [Shutting down the projector on page 42](#)), unplug the power cable, and let it cool down completely.

- Use a canister of compressed air to remove dust.
- If there is dirt or smears, use lens-cleaning paper or moisten a soft cloth with lens cleaner and gently wipe the lens surface.
- Never use any type of abrasive pad, alkaline/acid cleaner, scouring powder, or volatile solvent, such as alcohol, benzene, thinner or insecticide. Using such materials or maintaining prolonged contact with rubber or vinyl materials may result in damage to the projector surface and cabinet material.

---

 Never touch the lens with your finger or rub the lens with abrasive materials. Even paper towels can damage the lens coating. Only ever use a proper photographic lens brush, cloth, and cleaning solution. Do not attempt to clean the lens while the projector is switched on or is still hot from previous use.

---

## Storing the projector

To store the projector for an extended time:

- Make sure the temperature and humidity of the storage area are within the recommended range for the projector. Refer to Specifications or consult your dealer about the range.
- Retract the adjuster feet.
- Remove the batteries from the remote control.
- Pack the projector in its original packing or equivalent.

## Transporting the projector

It is recommended that you ship the projector with its original packing or equivalent.

## Extending LED life

The projection LED is an 200AL LED bulb which features a light-source life far beyond traditional bulbs, yet it is still a consumable item. To keep the lamp life as long as possible, you can change the following settings via the settings menu.

To access the settings menu, see [Using the Settings menu on page 85](#) for details.

## Setting LED Mode

Set the projector **Light Mode** to **Eco** to extend the lamp life.

LED mode	Description
<b>Normal</b>	100% lamp brightness
<b>Eco Mode</b>	This setting reduces system noise and power consumption by 30%. If <b>Eco Mode</b> is selected, the light output will be reduced and result in darker projected pictures.
<b>Battery Mode</b>	<b>Battery Mode</b> reduces system noise and power consumption to fulfill 3 hours projection*. If Battery mode is selected, the light output will be reduced and result in darker projected pictures.  *The 3 hours of projection is under the following testing conditions: <ul style="list-style-type: none"><li>• <b>Light Mode: Battery Mode</b></li><li>• <b>Picture Mode: Vivid TV</b> mode</li><li>• Audio volume: 50% and playing from GS2</li><li>• <b>Bluetooth: On</b>, but not connected to other device</li><li>• <b>Wireless Network: On</b> and connected.</li></ul>

1. Select **Settings > Picture > Picture Mode > Light Mode**.
2. Press (◀/▶) to move to your desired mode.
3. When done, press to ↵ your changes and exit.

## Setting Auto Power Off

This function allows the projector to turn off automatically if no action is detected after a set period of time.

1. Select **Settings > Parental Control > Auto Power Off** and press **OK**.
2. Press (**▲/▼**) to select a time period.
3. When done, press **↵** to save your changes and exit.

# Troubleshooting

Problem	Cause	Remedy
The projector does not turn on.	There is no power from the power cable.	Plug the power cable into the AC inlet on the rear of the projector, and plug the power cable into to the power outlet. If the power outlet has a switch, make sure that it is switched on.
	The battery is running out and in low voltage.	Plug in power adapter to charge the projector until the LED indicator turns to breathing green; then press and hold the power key on the projector for 3 seconds to turn it on.
No Google Play.	<b>Aptoide</b> , instead of Google Play, is provided for streaming apps download.	On the <b>BenQ Launcher</b> home screen, select the <b>Aptoide</b> icon to access the app market and download apps for streaming contents.
The projector cannot project the screen on mobile phones or laptops via USB-C™ cables.	The mobile phones or laptops do not have DisplayPort functionality.	Make sure the USB-C™ port on the device has DisplayPort functionality (with a DisplayPort IC inside), supports DisplayPort version 1.1 (or above) and timings as listed in <a href="#">Timing chart on page 126</a> .
	The USB-C™ cable is not compatible.	Use a USB-C™ Gen 3.1 cable to ensure sufficient bandwidth for media data transmission.
The projector cannot connect with Bluetooth speakers or headphones.	The Bluetooth function is not enabled.	Make sure the Bluetooth function on both the Bluetooth device and the projector are enabled. See <a href="#">Pairing/Connecting to a Bluetooth speaker or headphones on page 79</a> for more details.
	The Bluetooth device and the projector are not within an 8 meter range of each other.	

Problem	Cause	Remedy
The projector cannot play files in storage devices via USB-A ports.	The storage device is not connected to the projector properly.	The projector has one USB-C™ port, and no USB-A port. Use a certified USB-A to USB-C™ adapter to connect the projector to devices with USB-A ports. See <a href="#">Media Player on page 71</a> for more details.
	The projector does not support the file formats.	See <a href="#">Supported file formats on page 128</a> for more information about file formats supported by the projector.
Screen brightness is changed.	The adapter is removed.	The lamp brightness is decreased in <b>Battery Mode</b> to support 3 hours of projection. If a brighter screen is preferred, connect the power adapter to the projector or change the <b>Light Mode</b> to any mode other than <b>Battery Mode</b> .
	The adapter is not removed but the <b>Light Mode</b> is switched to <b>Battery Mode</b> .	
No input source.	The video source is not turned on or connected correctly.	Turn the video source on and check that the signal cable is connected correctly.
	The projector is not correctly connected to the input source device.	Check the connection. If input source is the USB-C™ port, make sure the source device supports DisplayPort and is connected to the projector with a USB-C™ Gen 3.1 cable.
	The video or audio file format is not supported by the projector.	Make sure the supported file format as described in <a href="#">Supported file formats on page 128</a> is being played, or contact the customer service for assistance.

Problem	Cause	Remedy
Image or audio is unstable.	The connection cables are not securely connected to the projector or the signal source.	Correctly connect the cables to the appropriate terminals.
	The Internet bandwidth is limited or over-occupied.	Connect to another wireless AP or to an Internet channel of better speed.
	The projector is out of effective range of Bluetooth connection.	Make sure the projector is within the effective range of Bluetooth connection. Make sure there is as less radio frequency interference as possible when using a 2.4G network.
Picture is blurred.	The projection lens is not correctly focused.	Adjust the focus of the lens using focus key on the remote control.
	The projector and the screen are not aligned properly.	Adjust the projection angle and direction as well as the height of this projector if necessary.
Remote control does not work correctly.	The batteries are out of power.	Replace both of the batteries with new ones.
	There is an obstacle between the remote control and the projector.	Remove the obstacle.
	You are too far away from the projector.	Stand within 8 meters (26.2 feet) of the projector.
The projector cannot find the desired SSID.	The radio frequency of the router is out of range.	<ul style="list-style-type: none"> <li>• For 2.4G frequency, make sure the router's SSID is at channel 1 to 11.</li> <li>• For 5G frequency (A and C SKU), make sure the router's SSID is at channel 36, 40, 44, 48, 149, 153, 157 or 161.</li> <li>• For 5G frequency (E SKU), make sure the router's SSID is at channel 36, 40, 44 or 48.</li> </ul>

Problem	Cause	Remedy
The projector cannot connect to the desired SSID.	The handshaking between the projector and the router does not follow IEEE 802.11 protocols.	<ul style="list-style-type: none"> <li>• For 2.4G frequency, make sure the wireless mode of the router is configured as 802.11g/n or 802.11n.</li> <li>• For 5G frequency, make sure the wireless mode of the router is configured as 802.11n.</li> </ul>



# Specifications

## Projector specifications



All specifications are subject to change without notice.

GS2 Projector Specifications	
<b>Projection System</b>	DLP 3438
<b>DMD Type</b>	0.3"
<b>Native Resolution</b>	1280 x 720 pixels
<b>Brightness</b>	500 lm
<b>Contrast Ratio (FOFO)</b>	100,000:1
<b>Display Color</b>	1.07 Billion Colors
<b>Aspect Ratio</b>	Native 16:9
<b>Light Source</b>	Osram Q8A LED
<b>Light Source Life<sup>(1)</sup></b>	20,000 hours (Normal) / 30,000 hours (Eco)
<b>Throw Ratio</b>	1.3 (35"@1M)
<b>Zoom Ratio</b>	Fixed
<b>Keystone Correction</b>	1D, Vertical $\pm$ 40 degrees
<b>Projection Offset</b>	100% $\pm$ 5%
<b>Projection Size (Clear Focus / Maximum)</b>	30 to 100 inches
<b>SoC</b>	MStar 648

GS2 Projector Specifications

<b>OS</b>	Android 6.0	
<b>RAM</b>	2G LPDDR3	
<b>Flash</b>	8G EMMC	
<b>WLAN<sup>(2)</sup></b>	IEEE 802.11 a/b/g/n/ac, 2.4G/5G	
<b>2.4G</b>	A and C SKU	Ch1-Ch11
	E SKU	
<b>5G</b>	A and C SKU	Band1: Ch36, Ch40, Ch44, Ch48
		Band4: Ch149, Ch153, Ch157, Ch161, Ch165
	E SKU	Band1: Ch36, Ch40, Ch44, Ch48
<b>Bluetooth</b>	4.0	
<b>Interface</b>	<ul style="list-style-type: none"> <li>• USB-A (2.0/1.5A/Reader) x1</li> <li>• USB-C™ (DisplayPort 1.2, 5V 1A)<sup>(3)</sup> x1</li> <li>• HDMI 1.4a x1</li> <li>• 3.5mm Audio Out x1</li> <li>• Wireless dongle port (WDR02U)</li> <li>• Factory Reset Button x1</li> </ul>	
<b>Antenna</b>	Yes	

GS2 Projector Specifications		
<b>Feature</b>	<ul style="list-style-type: none"> <li>• IPX2,</li> <li>• Parental Control,</li> <li>• LumiExpert™,</li> <li>• Wireless Projection<sup>(4)</sup> (for iOS/macOS®, for Android™, for PC),</li> <li>• USB-C™ DisplayPort and USB-A Reader,</li> <li>• 15 Degrees Tiling Stand,</li> <li>• Auto Focus,</li> <li>• Auto Vertical Keystone,</li> <li>• 3 Hours Battery</li> </ul>	
<b>Power</b>	<b>DC Supply</b>	
	Frequency	AC 100 to 240V 50/60HZ 1.5A
	Power Rating	19.0V 3420.0mAh, approximately 65.0W
	<b>Battery Life</b>	
	Type	Lithium-ion battery
	Electrical Rating	11.1V 6000.0mAh, 66.6W
	Battery Cycle Life	500 cycles
	Charging Time	3 hours from 0% to 100%
	Battery Life	3 hours in battery mode
<b>Built-in Speaker</b>	2W Chamber x 2	
<b>Resolution Support</b>	VGA (640 x 480) to 1080p (1920 x 1080)	
<b>Horizontal Frequency</b>	15 to 102 KHz	
<b>Vertical Scan Rate</b>	23 to 85 Hz	
<b>HDTV Compatibility</b>	480i, 480p, 576i, 576p, 720p, 1080i, 1080p	

## GS2 Projector Specifications

<b>Video Compatibility</b>	NTSC / NTSC4.43 / PAL / M-PAL / N-PAL / PAL60 / SECAM / HDTV
<b>Dimensions</b>	139 (W) x 144 (H) x 139 (D) mm
<b>Weight</b>	1.5 Kg
<b>Noise Level</b>	31 dBA (Normal) / 28 dBA (Eco)
<b>Working Temperature</b>	0°C to 40°C
<b>Accessories (Standard)</b>	<ul style="list-style-type: none"> <li>• Power Adaptor x 1</li> <li>• Power Cord x 1 (by region)</li> <li>• Wireless Dongle (WDR02U) x1 (detachable)</li> <li>• Remote Control (with one RC2032 battery)</li> <li>• Quick Start Guide</li> <li>• Warranty Card (by region)</li> <li>• Carry Bag</li> </ul>
<b>On Screen Display Language</b>	English / French / German / Japanese / Korean / Portuguese / Simplified Chinese / Spanish / Traditional Chinese / Arabic / Hindi / Italian



- <sup>(1)</sup>: Lamp life results will vary depending on environmental conditions and usage.
- <sup>(2)</sup>: The wireless projection and Bluetooth features are supported by detachable BenQ Wireless Dongle, WDR02U.
- <sup>(3)</sup>: Maximum resolution: 1080P (1920 \* 1080) 60Hz. Maximum data transfer speeds: 2.7Gbps.
- <sup>(4)</sup>: The performance of WLAN and Bluetooth might be disturbed by distance and obstacles.

## Dimensions

139 (W) x 144 (H) x 139 (D) mm

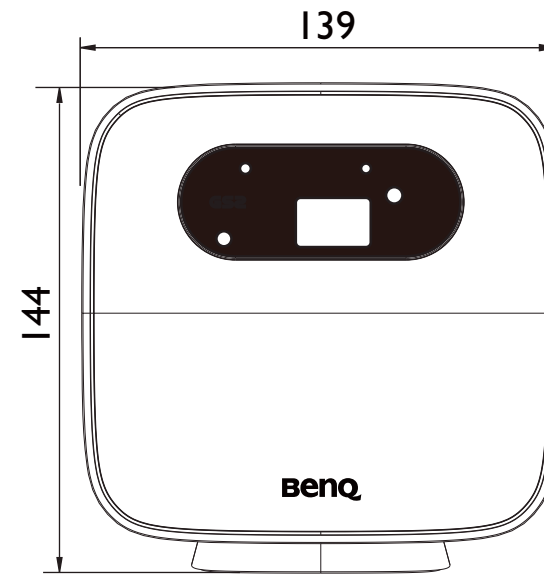
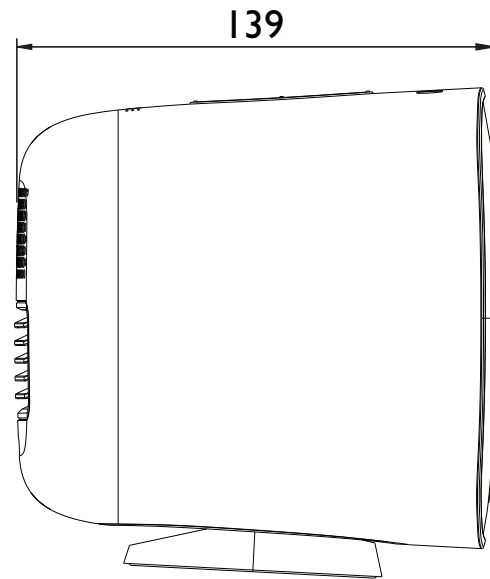

## Timing chart

### Supported timing for video input

Timing	Resolution	H. Frequency (KHz)	V. Frequency (KHz)	Dot Clock Frequency (MHz)
DMT0659	640 x 480p	31.469	59.94	25.175
480p	720 x 480p	31.469	59.94	27
720p	1280 x 720p	45	60	74.25
1080i	1920 x 1080i	33.75	60	74.25
480i	720 (1440) x 480i	27	59.94	15.734
1080p	1920 x 1080p	67.5	60	148.5
576p	720 x 576p	31.25	50	27
720p50	1280 x 720p	37.5	50	74.25
1080i25	1920 x 1080i	28.125	50	74.25
576i	720 (1440) x 576i	15.625	50	27
1080p50	1920 x 1080p	56.25	50	148.5
1080p24	1920 x 1080p	27	23.97	74.25
1080p30	1920 x 1080p	33.75	23.97	74.25

### Supported timing for PC input

Resolution	Mode	Refresh Rate (Hz)	H. Frequency (KHz)	Dot Clock Frequency (MHz)
640 x 480	VGA_60	59.94	31.469	25.175

Resolution	Mode	Refresh Rate (Hz)	H. Frequency (KHz)	Dot Clock Frequency (MHz)
800 x 600	SVGA_60	60.317	30.879	40
1024 x 768	XGA_60	60.004	48.363	65
1280 x 720	WXGA_60	60	45	74.25
1280 x 1024	SXGA_60	60.02	63.981	108
1360 x 768	1360 x 768_60	60.015	47.712	85.5
1440 x 900	WXGA+_60	59.901	55.469	88.75
1920 x 1080	FHD_60	60	67.5	148.5

 The timings showing above may not be supported for due to EDID file and VGA graphic card limitations. It is possible that some timings cannot be chosen.

## Supported file formats

File type	File extension
Documents	.txt
Photos	JPG(.jpg, .jpeg), PNG(.png), BMP(.bmp)
Music	MP3(.mp3), AAC(.aac)
Video	XVID(.avi) MPEG-4(3gp, mp4) H.263(3g2, .avi, .mkv, .webm, 3gp, mp4)
Subtitles	N/A



Bit rate range: If the peak bit rate of a video file is larger than 10MB, it might cause video playback lag.