



LaCie 1big Dock SSD Pro User Manual



Click here to access an up-to-date online version of this document. You will also find the most recent content as well as expandable illustrations, easier navigation, and search capability.

Contents

1	Introduction	5
	Box content	5
	Minimum computer system requirements	5
2	System Overview	6
	Views	6
	• Front view	6
	• Rear panel view	6
	Specifications	7
	• Dimensions	7
	• Weight	8
	• Electrical	8
	• Temperature ranges	8
3	System LEDs	9
	LED locations	9
	LED behavior	9
4	Cables	10
5	Getting Started	11
	Connect power cable	11
	Connect to computer	11
	Set up LaCie 1big Dock SSD Pro	12
	• Start here	12
	• Register your device	13
	• Download Toolkit	13
	• Install Toolkit	14
	Storage format	14
	Disconnecting the drive	15
6	Operation	16
	Power on	16
	Power off	16
	Long push	16
	Removing the Thunderbolt cable during operation	17
	Quiet operation and heat management	17
	Position and stacking	17

7	Docking Features	18
	USB 3.0 Hub	18
	• Connecting a device to the USB 3.0 hub	18
	• Safely ejecting and disconnecting a device from the USB 3.0 hub	18
	• macOS	18
	• Windows	19
	Secure Digital Extended Capacity (SDXC) memory card reader	19
	• Reading an SD memory card	19
	• Safely ejecting and removing an SD memory card	19
	• Toolkit	19
	• macOS	20
	• Windows	20
	CFast 2.0 memory card reader	20
	• Reading a CFast 2.0 memory card	20
	• Safely ejecting and removing a CFast 2.0 memory card	21
	• Toolkit	21
	• macOS	21
	• Windows	21
	CFexpress memory card reader	21
	• Reading a CFexpress memory card	22
	• Safely ejecting and removing a CFexpress memory card	22
	• Toolkit (macOS only)	22
	• macOS	22
	• Windows	23
8	Expansion Port	24
	DisplayPort 1.4	24
	• Connecting the DisplayPort	24
	• Disconnecting the DisplayPort	24
9	Daisy Chain, Power Delivery & Power Pass-Through	25
	How to daisy chain	25
	Power delivery and power pass-through	25
	• Power pass-through	26
10	Safely Remove LaCie 1big Dock SSD Pro From Your Computer	27
	Mac	27
	• Eject via Finder window	27
	• Eject via Desktop	27
	Windows	27
11	Optional Formatting and Partitioning	29
	About file system formats	29

- How to choose the file system format..... 29
- Manual formatting..... 30**
- Mac..... 30
 - macOS version 10.11 and later..... 30
- Windows..... 30

12 .Frequently Asked Questions 32

- All users 32**
- Problem: My file transfers are too slow..... 32
- Problem: I have a USB-C hard drive that I want to add to the Thunderbolt 3 daisy chain..... 32
- Problem: I must password protect and/or encrypt my hard drive..... 33
- Problem: I'm receiving file transfer error messages..... 33
- Mac..... 33**
- Problem: The drive icon does not appear on my desktop..... 33
- Windows 34**
- Problem: The drive icon doesn't appear in Computer..... 34

13 .Regulatory Compliance 35

- FCC Declaration of Conformance 35
- FCC Class A Information 35
- FCC Caution 35
- Important Note: FCC Radiation Exposure Statement 36
- Industry Canada 36
- Important Note for mobile device use 36
- Note Importante pour l'utilisation de dispositifs mobiles 36
- Europe – EU Declaration of Conformity 36
- China RoHS 38
- Taiwan RoHS 39

Introduction

LaCie® 1big Dock SSD Pro is a Thunderbolt™ 3 storage hub featuring accelerated NVMe™ SSD speeds of up to 2800MB/s, cinema-grade card slots, and a DisplayPort 1.4 output for pro 4K monitors. Equipped with a professional NVMe SSD and self-cooling design, 1big Dock SSD Pro is where long-term reliability meets optimized performance.

This manual provides details on configuring and using your LaCie 1big Dock SSD Pro. For common questions and answers, see [Frequently Asked Questions](#). You can get support and updated technical information at [LaCie customer support](#).

Box content

- LaCie® 1big Dock SSD Pro
- Thunderbolt 3 (40Gb/s) cable
- External power supply
- Quick Install Guide



Important info: Save your packaging. In the event that the hard drive enclosure should need to be repaired or serviced, it must be returned in its original packaging.

Minimum computer system requirements

- Computer with a Thunderbolt 3 port
- macOS® 10.14 or later / Windows® 10 or later
- Minimum free disk space: 600MB recommended

System Overview

Views

Front view

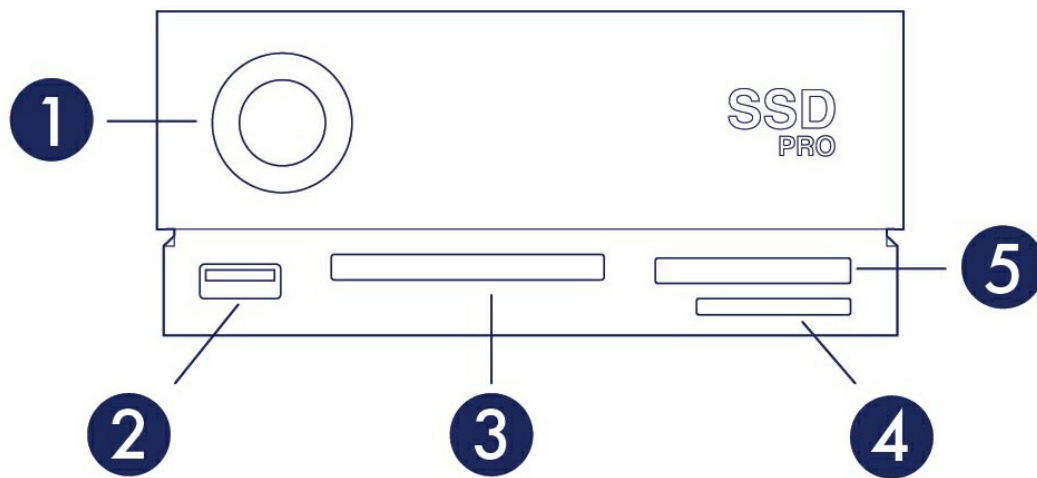

1. **Status LED**—Indicates that the device is powered on. See [Operation](#).
2. **USB 3.0 hub**—Connect shuttle drives, digital cameras, and other devices to transfer files. Charge devices like mobile phones (7.5W power output). See [Docking Features](#).
3. **CFast 2.0 slot**—Read CFast 2.0 memory cards. See [Docking Features](#).
4. **Secure Digital (SDXC) slot**—Read SD memory cards. See [Docking Features](#).
5. **CFexpress slot**—Read CFexpress memory cards. See [Docking Features](#).

Rear panel view

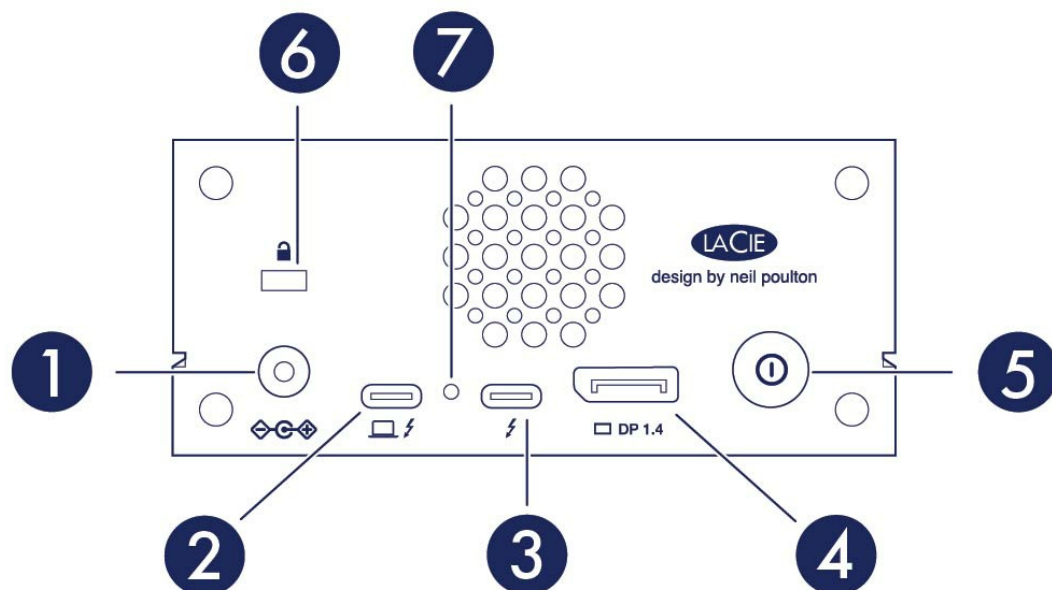

1. **Power input**—Connect the power cable. Only use the power cable included with your LaCie 1big Dock SSD Pro. Attaching third-party or other LaCie power cables with incorrect voltage can damage the device. See [Operation](#).
2. **Host port**—Thunderbolt 3 port that connects to a Thunderbolt 3 port on the host computer. Use the provided Thunderbolt 3 cable. See [Getting Started](#).
3. **Peripheral port**—Thunderbolt 3 port that connects compatible peripheral devices and displays. Use this port to connect a single Thunderbolt 3/USB-C device or to daisy-chain multiple Thunderbolt devices. You can also use this port to connect your laptop's USB-C power supply to the peripheral port and deliver up to 80W to the laptop connected to the host port. See [Daisy Chain, Power Delivery & Power Pass-Through](#).
4. **DisplayPort**—Send the video signal from your computer to a monitor. See [Expansion Port](#).
5. **Manual shutdown button**—Press and hold this button for more than 4 seconds to cut power and shut down 1big Dock SSD Pro. This button allows you to conserve power without having to unplug 1big Dock SSD Pro. See [Operation](#).
6. **Kensington™ lock port**—Use this port to physically lock 1big Dock SSD Pro to a desk or rack.
7. **Firmware update button**—Updates to the USB firmware are posted on the support page to enhance your product. Only press this button when following instructions to update the USB firmware. Use a thin rigid wire (such as the end of a paperclip) to push the button within the enclosed space.

Specifications

Dimensions

Side	Dimensions (in/mm)
Length	4.646in/118mm
Width	2.217in/56.3mm
Depth	8.543in/217mm

Weight

Model	Weight (lb/kg)
1big Dock SSD Pro	2.866lb/1.3kg

Electrical

Power adapter 20V@5.5A

! Use only the power supply provided with your device. Power supplies from other LaCie, Seagate, and third-party devices can damage your 1big Dock.

Temperature ranges

Ambient environment	Temperature range
Standard (operating)	5 to 35 °C

System LEDs

LaCie 1big Dock SSD Pro LEDs provide information on the system status.

LED locations

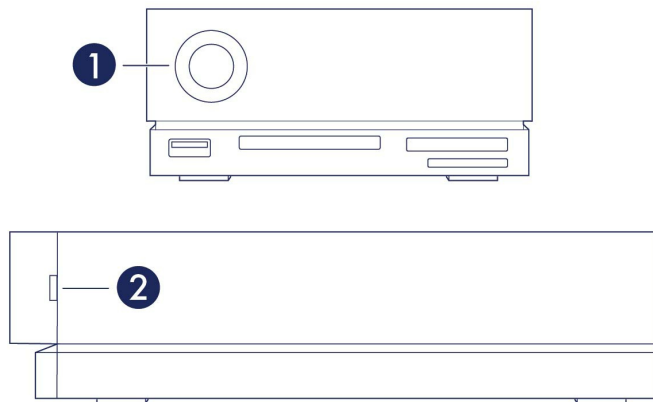

1. **Front**—System status
2. **Side**—Drive status

LED behavior

The list of colors below helps you identify the general status of LaCie 1big Dock SSD Pro.

Color	State
Solid blue	Ready
Fast blinking blue	Startup and shutdown
Blinking red (1 second interval)	Warning temperature or fan failure
Solid red	Critical temperature or absent fan

Cables

Use the Thunderbolt 3 cable to connect 1big Dock's host port to a Thunderbolt 3 port on your computer.

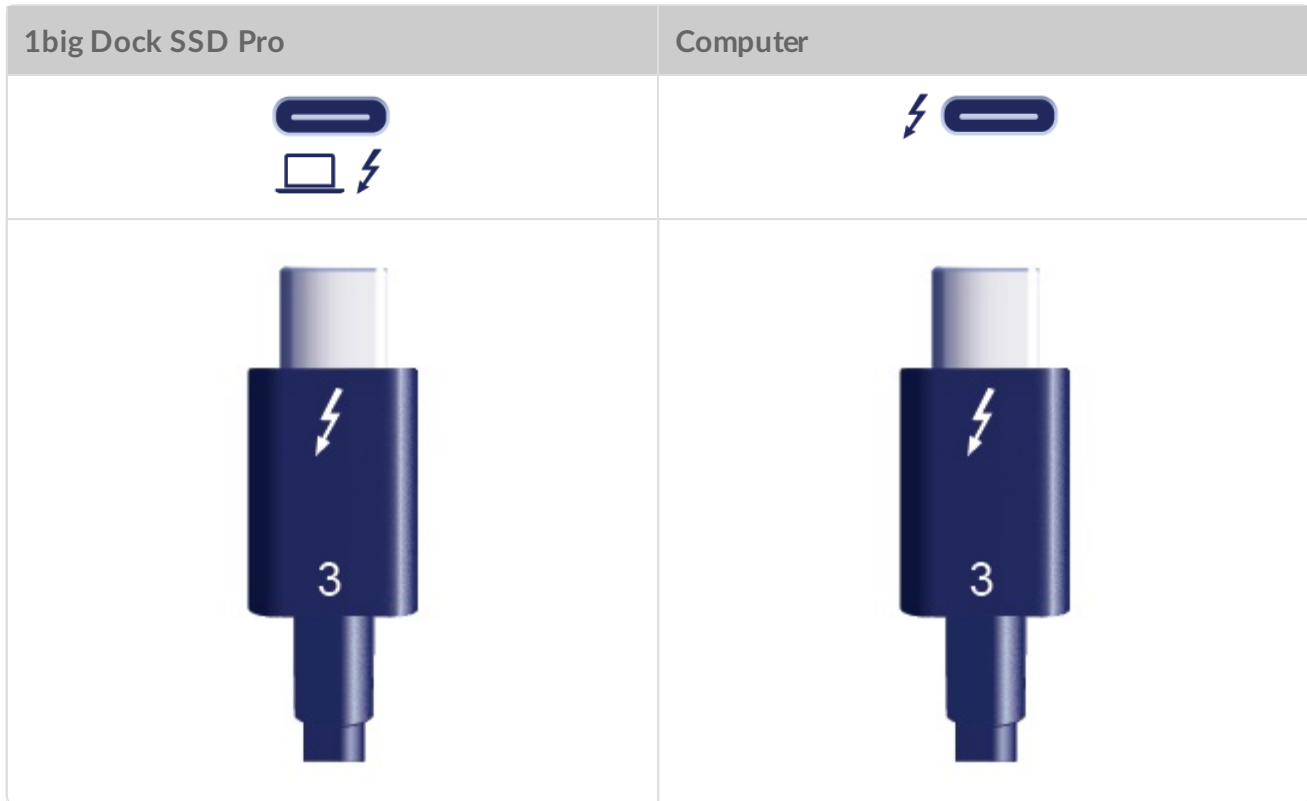

- ! 1big Dock SSD Pro only supports connections to a computer's Thunderbolt 3 port. The drive is not available when connected to a USB port.

Getting Started

1 Connect power cable

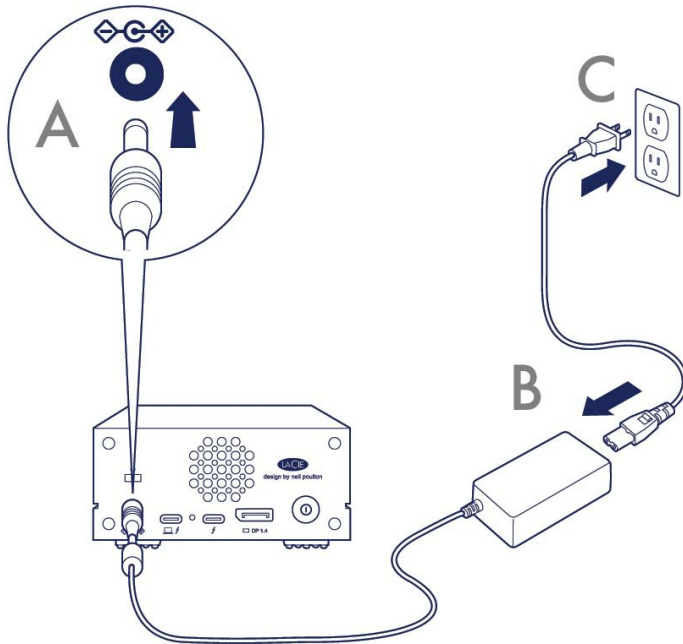

2 Connect to computer

Use the Thunderbolt 3 cable to connect 1big Dock SSD Pro's host port to your computer's Thunderbolt 3 port.

- ! **Important**—Your computer must be connected to 1big Dock SSD Pro's host port to power on and access the drive.



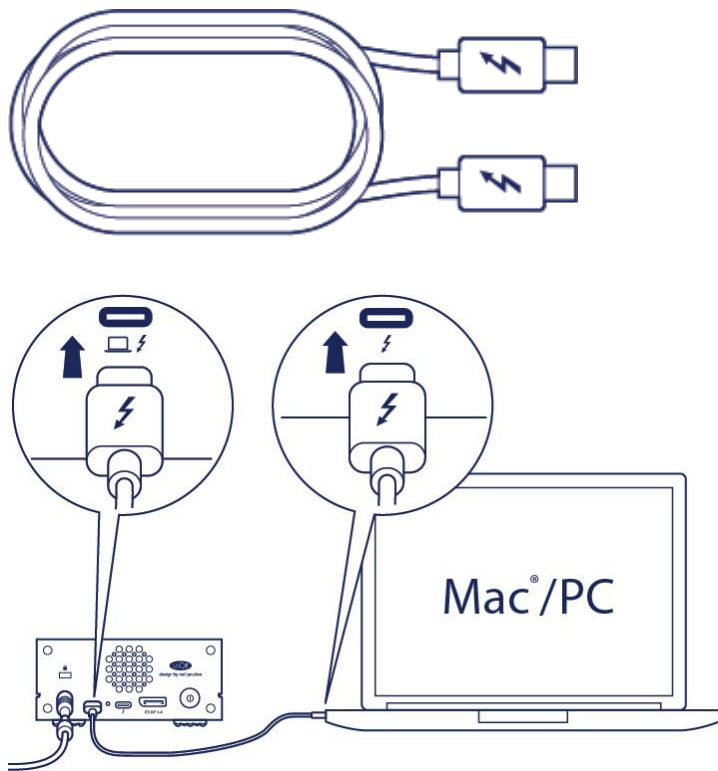

3 Set up LaCie 1big Dock SSD Pro

The setup process lets you:

Register LaCie 1big Dock SSD Pro

Get the most from your drive with easy access to information and support.

Install Toolkit

Manage Sync Plus plans, automate imports from memory cards, control LED settings, and more.



Your computer must be connected to the internet to register your device and install Toolkit.

A Start here

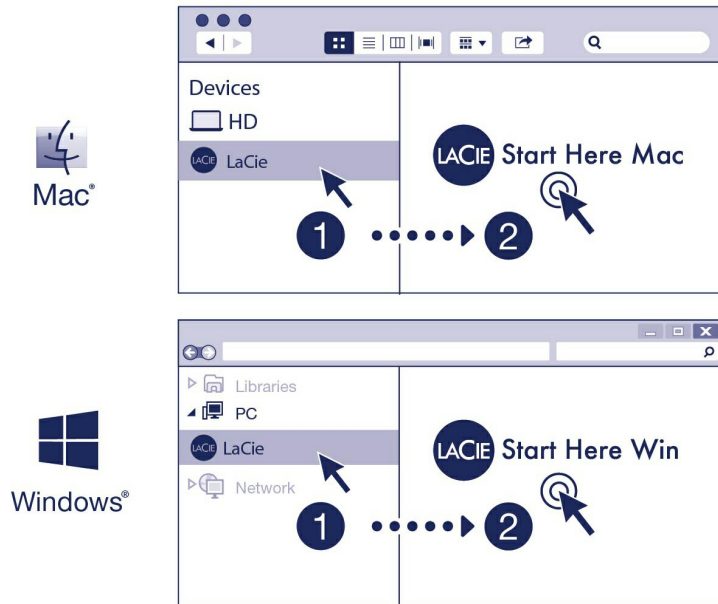

Using a file manager such as Finder or File Explorer, open LaCie 1big Dock SSD Pro and launch [Start Here Mac](#) or [Start Here Win](#).

B Register your device

The registration form is titled 'Register'. It contains three input fields: the first contains 'Jane', the second contains 'Doe', and the third contains 'jdoe@example.com'. Below these fields is a section titled 'I have read and agree to...' with three checked checkboxes: 'Terms and Conditions', 'Privacy Statement', and 'Optional Offers'. At the bottom left of the form is a blue 'Register' button.

Enter your information and click [Register](#).

C Download Toolkit



Click the [Download](#) button.

D Install Toolkit

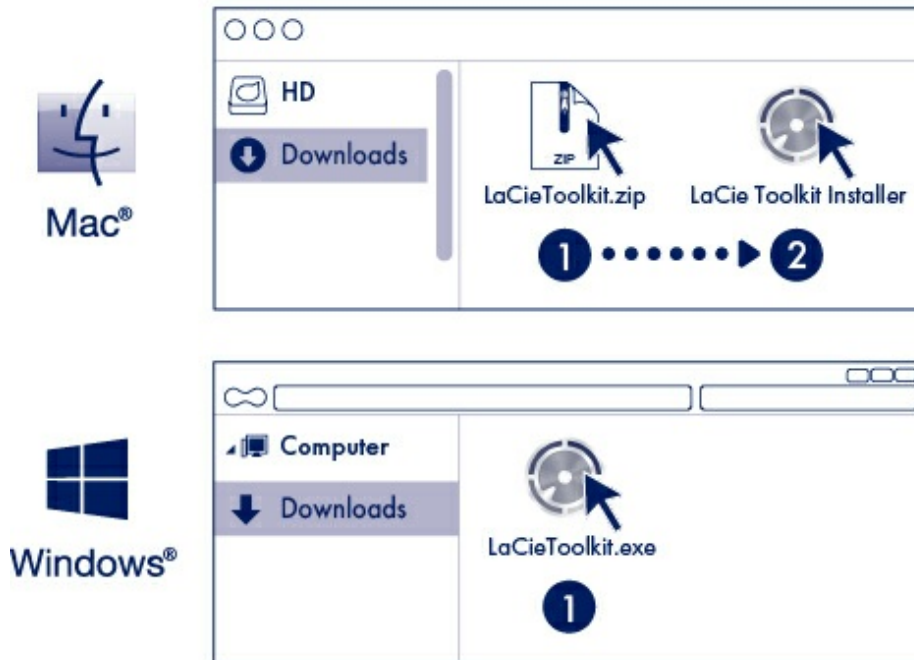

Using a file manager such as Finder or File Explorer, go to the folder where you receive downloads.



Open the [LaCieToolkit.zip](#) file. Click on the [LaCie Toolkit Installer](#) to launch the application.



Click on the [LaCieToolkit.exe](#) file to launch the application.



Your computer must be connected to the internet to install and run Toolkit.

For details on Toolkit features, see the [LaCie Toolkit user manual](#).

Storage format

1big Dock SSD Pro is preformatted exFAT for compatibility with both Windows and Mac computers. If you use the drive with only one type of computer, you can optimize file copy performance by formatting it in the native file system for your operating system. See [Optional Formatting and Partitioning](#) for details.

Disconnecting the drive

In order to avoid file system corruption, it's important to unmount 1big Dock SSD Pro's volumes before disconnecting the interface cable. See [Safely Remove LaCie 1big Dock SSD Pro From Your Computer](#) for details.

Operation

Power on

LaCie 1big Dock SSD Pro powers on when:

- Connected to a computer that supports Thunderbolt 3.
- Plugged into a live power outlet.



Caution: Do not operate 1big Dock SSD Pro until the ambient temperature is within the specified temperature range. See [System Overview](#).

Power off

Follow the steps below to turn the device off:

1. Make certain that the device's volumes are not being accessed.
2. Eject 1big Dock SSD Pro from your computer's operating system.



Important info: Always safely eject 1big Dock SSD Pro from your computer before powering off. See [Safely Remove 1big Dock SSD Pro From Your Computer](#).

3. Disconnect the device from your computer.

Long push

You can cut power and shut down 1big Dock SSD Pro, allowing you to conserve power without having to unplug the device. Press and hold the **Manual shutdown** button for more than four seconds to manually shut off 1big Dock SSD Pro.



To reduce risk of data loss, always safely eject 1big Dock SSD Pro from your computer before power off the device.

Removing the Thunderbolt cable during operation

Removing the cable connecting 1big Dock SSD Pro to your computer during operation can result in lost data. Safely eject 1big Dock's volumes before disconnecting the device. See [Safely Remove LaCie 1big Dock SSD Pro From Your Computer](#).

Quiet operation and heat management

To reduce noise during operation, 1big Dock SSD Pro uses a Noctua® cooling fan to pull heat away from the internal components. The cooling fan is temperature controlled, which guarantees optimal heat management by adjusting the rotational speed for the environment. Additionally, the enclosure's metal casing dissipates heat from the drive, keeping it safe and prolonging its life. Since LaCie's unique design draws heat away from the internal drive, the external casing may be warm to the touch after extended use.

i **Important info:** The wide exhaust chamber on the rear of 1big Dock allows for enhanced airflow. Make sure that it is not obstructed and that there is a natural airflow across the casing.

Position and stacking

Always make certain to place 1big Dock SSD Pro on a flat, even surface designed to support the heat output and airflow of the enclosure. For proper heat dissipation, 1big Dock is designed to stand on its rubber feet, situated on the bottom of the enclosure. **DO NOT** place the enclosure on its side when it is powered on.

Docking Features

LaCie 1big Dock SSD Pro provides you with convenient means of managing your digital content. Insert SD, CFast 2.0, and CFexpress cards to transfer files for safe storage. Connect smartphones, cameras, and other devices to the USB 3.0 hub to access content.

USB 3.0 Hub

Use the hub to transfer files from digital cameras and other drives. The USB 3.0 hub port delivers 7.5W of power to connected phones and other devices.

Connecting a device to the USB 3.0 hub

1. Hold the USB 3.0 end of the cable upright.
2. Insert the cable end into the USB 3.0 port on the front of the device.

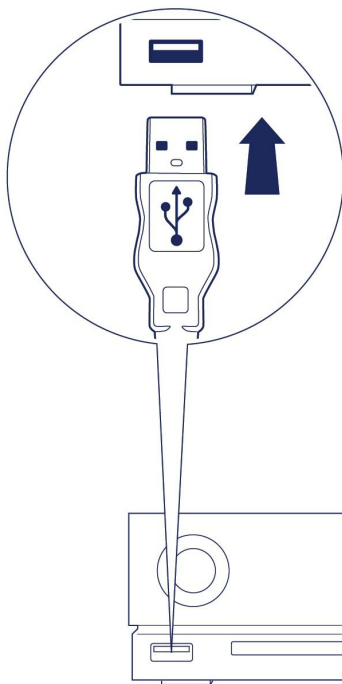

3. Open a Finder or File Explorer window to browse and manage the contents of the device.

Safely ejecting and disconnecting a device from the USB 3.0 hub

macOS

1. Make sure that the device is not being accessed.
2. Using a Finder window, eject the device volume.
3. Remove the USB 3.0 end of the cable from the port.

Windows

1. Click the Safely Remove icon in your Windows System Tray to view the devices you can eject. If you don't see the Safely Remove Hardware icon, click the Show Hidden Icons arrow in the system tray to display all icons in the notification area.
2. In the list of devices, choose the storage device you want to eject. Windows displays a notification when it is safe to remove the device.
3. Remove the USB 3.0 end of the cable from the port.

Secure Digital Extended Capacity (SDXC) memory card reader

Reading an SD memory card

1. Hold your SD, SDHC, or SDXC memory card upright with the label on top (pins on bottom).
2. Insert the card into the SD slot on the front of the device as far as it will go (you may hear an audible 'click'), and then release. The card is now locked in the slot.

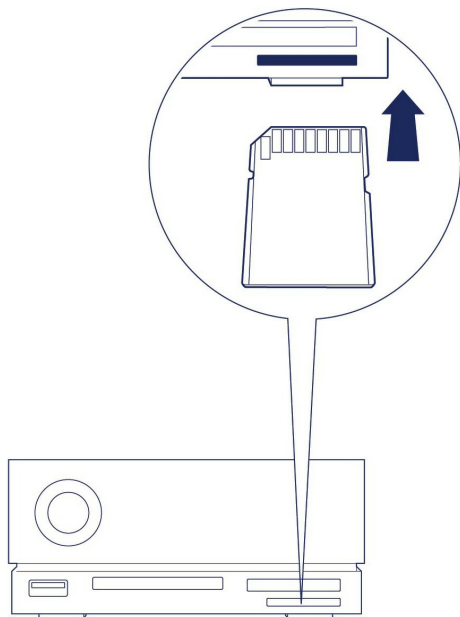

3. Open a Finder or File Explorer window to browse and manage the contents of the SD card.

Safely ejecting and removing an SD memory card

Toolkit

1. Make sure that the SD memory card is not being accessed.
2. Open Toolkit.
3. On the Home screen, click on the Eject icon for the SD card slot.
4. Push the card into the SD slot on the front of the device as far as it will go (you may hear an audible 'click'), and then release. The card is ejected.
5. Remove the card from the slot.

macOS

1. Make sure that the SD memory card is not being accessed.
2. Using a Finder window, eject the SD card volume.
3. Push the card into the SD slot on the front of the device as far as it will go (you may hear an audible 'click'), and then release. The card is ejected.
4. Remove the card from the slot.

Windows

1. Click the Safely Remove icon in your Windows System Tray to view the devices you can eject. If you don't see the Safely Remove Hardware icon, click the Show hidden icons arrow in the system tray to display all icons in the notification area.
2. In the list of devices, choose the SD card volume you want to eject. Windows displays a notification when it is safe to remove the device.
3. Push the card into the SD slot on the front of the device as far as it will go (you may hear an audible 'click'), and then release. The card is ejected.
4. Remove the card from the slot.

CFast 2.0 memory card reader

Reading a CFast 2.0 memory card

1. Hold your CFast 2.0 memory card upright with the label on top.
2. Insert the card into the CFast 2.0 slot on the front of the device and gently push it in until it's seated in the slot.

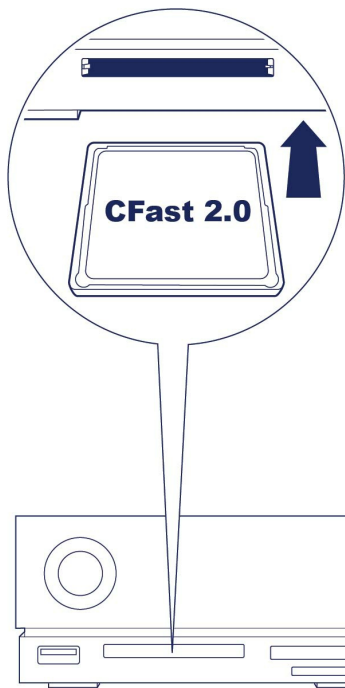

3. Open a Finder or File Explorer window to browse and manage the contents of the CFast 2.0 card.

Safely ejecting and removing a CFast 2.0 memory card

Toolkit

1. Make sure that the CFast 2.0 memory card is not being accessed.
2. Open Toolkit.
3. On the Home screen, click on the Eject icon for the CFast 2.0 card slot.
4. Remove the card from the slot.

macOS

1. Make sure that the CFast 2.0 memory card is not being accessed.
2. Using a Finder window, eject the CFast 2.0 card volume.
3. Remove the card from the slot.

Windows

1. Click the Safely Remove icon in your Windows System Tray to view the devices you can eject. If you don't see the Safely Remove Hardware icon, click the Show hidden icons arrow in the system tray to display all icons in the notification area.
2. In the list of devices, choose the CFast 2.0 card volume you want to eject. Windows displays a notification when it is safe to remove the device.
3. Remove the card from the slot.

CFexpress memory card reader

Reading a CFexpress memory card

1. Hold your CFexpress memory card upright with the label on top.
2. Insert the card into the CFexpress slot on the front of the device and gently push it in until it's seated in the slot.

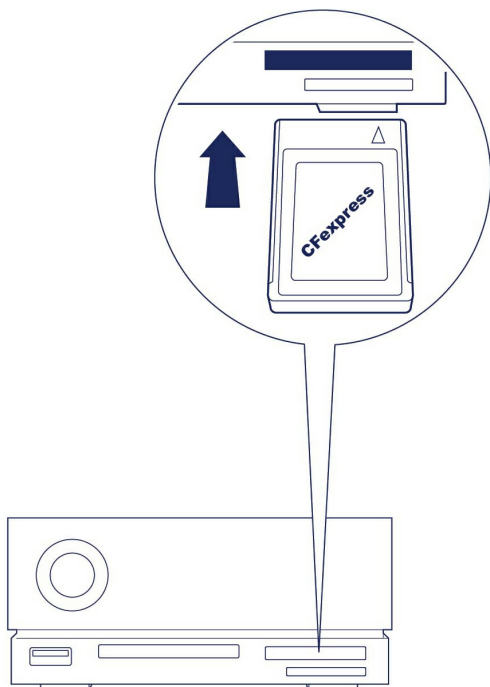

3. Open a Finder or File Explorer window to browse and manage the contents of the CFexpress card.



Important—LaCie 1big Dock SSD Pro supports CFexpress but not XQD media card format.

Safely ejecting and removing a CFexpress memory card

Toolkit (macOS only)

1. Make sure that the CFexpress memory card is not being accessed.
2. Open Toolkit.
3. On the Home screen, click on the Eject icon for the CFexpress card slot.
4. Remove the card from the slot.

macOS

1. Make sure that the CFexpress memory card is not being accessed.
2. Using a Finder window, eject the CFexpress card volume.
3. Remove the card from the slot.

Windows

In order to maximize copy performance, Windows treats a card inserted in the CFexpress slot as a non-removable drive. To safely remove a CFexpress card with reduced risk of data loss, eject LaCie 1big Dock SSD Pro from your computer before physically withdrawing the card from the slot.

1. Make sure that inserted memory cards are not being accessed.
2. Make sure that LaCie 1big Dock SSD Pro is not being accessed.
3. Click the Safely Remove icon in your Windows System Tray to view the devices you can eject. If you don't see the Safely Remove Hardware icon, click the Show hidden icons arrow in the system tray to display all icons in the notification area.
4. In the list of devices, choose LaCie 1big Dock SSD Pro to eject. Windows displays a notification when it is safe to disconnect the device.
5. Disconnect the Thunderbolt 3 cable from the PC and wait for 1big Dock to power down.
6. Remove the CFexpress card from the slot.
7. Reconnect the Thunderbolt 3 cable to power on 1big Dock.

Expansion Port

DisplayPort 1.4

DisplayPort is a digital display interface used to connect a video source to a display device (for example, a computer monitor) as well as other forms of digital data. DP 1.4 supports up to two 4K displays or one 5K display.

i LaCie 1big Dock SSD Pro provides the full performance available to DisplayPort 1.4. However, many computers with Thunderbolt ports do not support DisplayPort 1.4, which limits the outputs to displays. In addition, some displays do not accept the full bandwidth available to DisplayPort 1.4. Check the documentation for your computers and displays for DisplayPort 1.4 compatibility.

i DisplayPort may be compatible with some HDMI, DVI, and VGA adapters (not included). Note that these have not been tested.

Connecting the DisplayPort

1. Insert the DP 1.4 end of the cable or adapter into the port on the back of the 1big Dock until it clicks into place. The cable/adapter is now locked into the DP 1.4 port.
2. Connect the other end of the cable to your configured audio/video display.

Disconnecting the DisplayPort

1. Grasp the DP 1.4 end of the cable or adapter that's connected to 1big Dock.
2. Hold down the release tab with your thumb, and then pull back to remove the cable from the port.

Daisy Chain, Power Delivery & Power Pass-Through

Use the peripheral Thunderbolt 3 port on LaCie 1big Dock SSD Pro for:

- Direct connection to a device or display that is compatible with Thunderbolt 3 technology.
- Daisy chaining devices and displays that are compatible with Thunderbolt 3 technology.
- Connecting a laptop's USB-C power adapter in order to pass-through power to a laptop connected to 1big Dock's host Thunderbolt 3 port.

How to daisy chain

The peripheral Thunderbolt 3 port on 1big Dock SSD Pro can be used to daisy chain compatible Thunderbolt 3 peripherals, such as hard drives and monitors. If you have another Thunderbolt 3 storage device, make certain to connect it to the daisy chain before adding compatible displays or USB 3.1 (USB-C) devices. See below for an example of the order of devices in a Thunderbolt 3 daisy chain.

1. Computer with a Thunderbolt 3 port.
2. LaCie 1big Dock SSD Pro (connected to computer via host Thunderbolt 3 port).
3. LaCie d2 Thunderbolt 3 (connected to 1big Dock's peripheral Thunderbolt 3 port).
4. Second LaCie d2 Thunderbolt 3 (connected to first d2 via Thunderbolt 3 port).
5. LaCie Rugged SSD (connected to second d2 via Thunderbolt 3 port).

USB 3.1 (USB-C) devices can terminate a Thunderbolt 3 daisy chain and should always be the last device. It must be connected to the secondary Thunderbolt 3 port on the preceding device. (The USB 3.1 device will not be recognized if connected to the preceding device's USB-C port.)



Important cable info: When connecting 1big Dock's peripheral Thunderbolt 3 port to a compatible device, use cables specifically constructed to support Thunderbolt 3.

Power delivery and power pass-through

1big Dock SSD Pro delivers power to your connected laptop and compatible peripheral devices.

No device connected to peripheral port

Host port

Peripheral port

45W

-

Device connected to peripheral port

Host port

Peripheral port

30W

15W



1big Dock must receive power via its power cable in order to deliver power to compatible devices.



LaCie is not responsible for devices that experience harm, damage, or malfunction when connected to LaCie 1big Dock.

Power pass-through

With power pass-through, you can attach a laptop's USB-C power supply to 1big Dock's peripheral Thunderbolt 3 port and let 1big Dock 'pass' power to the laptop connected to 1big Dock's host Thunderbolt 3 port.

USB-C power supply connected to 1big Dock peripheral port	Power passed through to 1big Dock host port
> 60W and < 85W	56W
≥ 85W	80W

Safely Remove LaCie 1big Dock SSD Pro From Your Computer

Always eject a storage device from your computer before physically disconnecting it. Your computer must perform filing and housekeeping operations on the drive before it is removed. If you unplug the drive without using the operating system's software, your files can become corrupt or damaged.

Mac

There are several ways you can eject your storage device from a Mac. See below for two options.

Eject via Finder window

1. Open a Finder window.
2. On the sidebar, go to Devices and locate the storage device you want to eject. Click the Eject icon to the right of the storage device name.
3. Once the storage device disappears from the sidebar or, the Finder window closes, you can disconnect the interface cable from your Mac.

Eject via Desktop

1. Select the desktop icon for your storage device and drag it to the Trash.
2. When the storage device icon is no longer visible on your desktop, you can physically disconnect it from your Mac.

Windows

Use the Safely Remove tool to eject a storage device.

1. Click the Safely Remove icon in your Windows System Tray to view the devices you can eject.

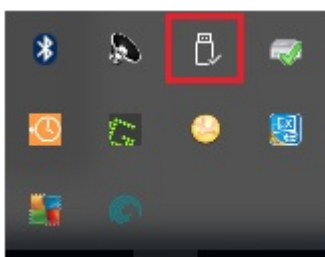

2. If you don't see the Safely Remove Hardware icon, click the Show hidden icons arrow in the system tray to display all icons in the notification area.
3. In the list of devices, choose the storage device you want to eject. Windows displays a notification when it is safe to remove the device.
4. Disconnect the storage device from the computer.

Optional Formatting and Partitioning

LaCie 1big Dock SSD Pro is preformatted exFAT for compatibility with both Mac and Windows computers. If you use the drive with only one type of computer, you can optimize file copy performance by formatting the drive in the native file system for your operating system.

About file system formats

NTFS—The native file system for Windows. macOS can read NTFS volumes but cannot natively write to them.

Mac OS Extended (HFS+)—An Apple file system optimized for macOS 10.12 and earlier. This file system remains the best option for external storage devices and is the only format compatible with Time Machine. Windows cannot natively read or write to HFS+ (journaled) volumes.

APFS (Apple File System)—An Apple file system optimized for solid state drives (SSDs) and flash-based storage systems. While APFS may benefit SSD performance, note the following restrictions:

- You cannot use an APFS-formatted disk as your Time Machine backup drive. Format LaCie 1big Dock SSD Pro to HFS+ if you intend to use it with Time Machine.
- APFS is only supported on macOS 10.13 or later.

exFAT—Compatible with macOS and Windows. exFAT is not a journaled file system which means it can be more susceptible to data corruption when errors occur or the drive is not disconnected properly from the computer.

How to choose the file system format

Use NTFS if:

...you connect the storage device to Windows computers, and you don't need to allow a Mac to write to the storage device.

Use HFS+ if:

...you connect the storage device to Mac computers, and you don't need to allow a Windows computer to read or write to the disk. HFS+ is the only format compatible with Time Machine.

Use APFS if:

...you connect the storage device to Mac computers, and you don't need to allow a Windows computer to read or write to the drive. Do not use APFS if you intend to back up using Time Machine to LaCie 1big Dock SSD Pro, or if your computer is not running macOS 10.13 or later.

Use exFAT if:

...you need to allow both Mac and Windows computers to read and write to the storage device.

Manual formatting

Use the steps below to manually format and partition a storage device.

! **Formatting erases everything on the storage device.** LaCie highly recommends that you **back up all data** on your storage device before performing the steps below. LaCie is not responsible for any data lost due to formatting, partitioning, or using a LaCie storage device.

Mac

macOS version 10.11 and later

1. Open the Finder and go to [Applications > Utilities > Disk Utility](#).
2. In the sidebar to the left, select your LaCie 1big Dock SSD Pro.



macOS starting version 10.13—Make sure to select the storage device and not just the volume. If you don't see two entries listed in the sidebar, change the view in disk utility to show both the drive and the volume. The view button is in the upper left side of the Disk Utility window. Change the view to Show All Devices. This feature was introduced in macOS 10.13 and is not available in 10.11 or 10.12.

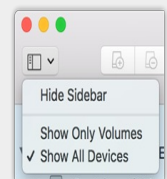

3. Select [Erase](#).
4. A dialog box opens. Enter a name for the drive. This will be the name displayed when the drive mounts.
5. For Format, select [OS X Extended \(Journaled\)](#).
6. For Scheme, select [GUID Partition Map](#).
7. Click [Erase](#).
8. Disk Utility formats the drive. When it's finished, click [Done](#).

Windows

1. Make sure the storage device is connected to and mounted on the computer.
2. Go to Search and then type Disk Management. In the search results, double-click [Disk Management](#).

3. From the list of storage devices in the middle of the Disk Management window, locate your LaCie device.
4. The partition must be available to format. If it is currently formatted, right click on the partition and then choose [Delete](#).
5. To create a new partition, right click on the volume and select [New Simple Volume](#). Follow the on-screen instructions when the New Simple Volume Wizard appears.

Frequently Asked Questions

For help setting up and using your LaCie hard drive, review the frequently asked questions below. For additional support resources, go to [LaCie customer support](#).

All users

Problem: My file transfers are too slow.

Thunderbolt 3

Q: Are both ends of the cable firmly attached?

A: Review troubleshooting tips for cable connections below:

- Check both ends of the cable and make sure they are fully seated in their respective ports.
- Try safely ejecting LaCie 1big Dock SSD Pro from your computer and then disconnect the cable. Wait 10 seconds and then reconnect 1big Dock to the computer.

Q: Are there other Thunderbolt 3 or USB devices connected to the same port or hub?

A: Disconnect other devices and see if the drive's performance improves.

Q: Is the device connected to a Thunderbolt 3 USB-C port on your computer or hub?

A: Connect 1big Dock to a USB-C port on your computer that supports Thunderbolt 3 devices. The lightning bolt icon that represents Thunderbolt 3 support should appear next to the USB-C port.

Q: Does your computer or operating system support Thunderbolt 3?

A: Consult your computer and operating system documentation for Thunderbolt 3 compatibility information.

Problem: I have a USB-C hard drive that I want to add to the Thunderbolt 3 daisy chain.

Q: Can I attach my USB-C hard drive to a Thunderbolt 3 daisy chain?

A: Yes. Make certain to add the USB-C hard drive to the end of a Thunderbolt 3 daisy chain since USB devices do not include a second port to continue the chain. Please note that USB-C devices do not become Thunderbolt 3 devices when added to a Thunderbolt 3 daisy chain. The USB-C device can only provide performance within its potential. For example, a USB 3.1 Gen 1 hard drive added to the end of a Thunderbolt 3 daisy chain can reach up to 5Gb/s while a USB 3.1 Gen 2 hard drive can reach up to 10Gb/s.

Problem: I must password protect and/or encrypt my hard drive.

Q: Can I password protect my hard drive?

A: Yes, it is possible to protect the hard drive or individual folders and files with a password. There are many third-party solutions for password protection. However, LaCie cannot guarantee them since we do not test third-party applications.

Some versions of Windows have a built-in utility called Bitlocker that can protect hard drives with a password. For more information about Bitlocker, consult [Microsoft's support documentation](#).

Q: Can I encrypt my hard drive?

A: Yes, the hard drive can be encrypted. There are many third-party solutions for encryption. However, LaCie cannot guarantee them since we do not test third-party applications.

Some versions of Windows have a built-in utility called Bitlocker that can encrypt hard drives. For more information about Bitlocker, consult [Microsoft's support documentation](#)

Problem: I'm receiving file transfer error messages.

Q: Did you get an "Error -50" message while copying to a FAT32 volume?

A: When copying files or folders from a computer to a FAT32 volume, certain characters in the names cannot be copied. These characters include, but are not limited to: ? < > / \ :

Check your files and folders to ensure that these characters are not in the names.

If this is a recurring problem or you cannot find files with incompatible characters, consider reformatting the drive to NTFS (Windows users) or HFS+ (Mac users). See [Optional Formatting and Partitioning](#).

Mac

Problem: The drive icon does not appear on my desktop.

Q: Is your Finder configured to hide hard drives on the desktop?

A: Go to Finder and then check **Preferences > General tab > Show these items on the desktop**. Confirm that **Hard Disks** is selected.

Q: Is your drive mounting in the operating system?

A: Open Disk Utility at **Go > Utilities > Disk Utility**. If the drive is listed in the left-hand column, check your Finder preferences to see why it is not displayed on the desktop (review the question above).

Q: Does your computer's configuration meet the minimum system requirements for use with this drive?

A: Refer to the product packaging for the list of supported operating systems.

Q: Did you follow the correct installation steps for your operating system?

A: Review the installation steps in [Getting Started](#).

Windows

Problem: The drive icon doesn't appear in Computer.

Q: Is the drive listed in Device Manager?

A: All drives appear in at least one place in Device Manager.

Go to Search and enter Device Manager to launch it. Look in the Disk Drives section and, if necessary, click the plus sign to view the full list of devices. If you're uncertain that your drive is listed, safely unplug it and then reconnect it. The entry that changes is your LaCie hard drive.

Q: Is your drive listed next to an unusual icon?

A: Windows Device Manager usually provides information about failures with peripherals. While the Device Manager can assist with troubleshooting most problems, it may not display the exact cause or provide a precise solution.

An unusual icon next to the hard drive can reveal a problem. For example, an exclamation point, question mark, or X instead of the normal icon based on the type of device could indicate a problem. Right click on the icon and then choose **Properties**. The General tab provides a potential reason why the device is not working as expected.

Regulatory Compliance

Product Name	LaCie 1big Dock SSD Pro
--------------	-------------------------

Regulatory Model Number	LRDMU05
-------------------------	---------

FCC Declaration of Conformance

This device complies with Part 15 of the FCC Rules. Operation is subject to the following two conditions: (1) this device may not cause harmful interference, and (2) this device must accept any interference received, including interference that may cause undesired operation.

FCC Class A Information

This equipment has been tested and found to comply with the limits for a Class A digital device, pursuant to Part 15 of the FCC Rules. These limits are designed to provide reasonable protection against harmful interference in a residential installation. This equipment generates, uses and can radiate radio frequency energy and, if not installed and used in accordance with the instructions, may cause harmful interference to radio communications. However, there is no guarantee that interference will not occur in a particular installation.

If this equipment does cause harmful interference to radio or television reception, which can be determined by turning the equipment off and on, the user is encouraged to try to correct the interference by one of the following measures:

- Reorient or relocate the receiving antenna.
- Increase the separation between the equipment and receiver.
- Connect the equipment into an outlet on a circuit different from that to which the receiver is connected.
- Consult the dealer or an experienced radio/TV technician for help.

This device complies with Part 15 of the FCC Rules. Operation is subject to the following two conditions: (1) This device may not cause harmful interference, and (2) this device must accept any interference received, including interference that may cause undesired operation.

FCC Caution

Any changes or modifications not expressly approved by the party responsible for compliance could void the user's authority to operate this equipment.

Important Note: FCC Radiation Exposure Statement

This equipment complies with FCC radiation exposure limits set forth for an uncontrolled environment. This equipment should be installed and operated with minimum distance 20cm between the radiator and your body. This transmitter must not be co-located or operating in conjunction with any other antenna or transmitter. The availability of some specific channels and/or operational frequency bands are country dependent and are firmware programmed at the factory to match the intended destination. The firmware setting is not accessible by the end user.

Industry Canada

This device complies with RSS-210 of the Industry Canada Rules. Operation is subject to the following two conditions: (1) This device may not cause harmful interference, and (2) this device must accept any interference received, including interference that may cause undesired operation.

Ce dispositif est conforme à la norme CNR-210 d'Industrie Canada applicable aux appareils radio exempts de licence. Son fonctionnement est sujet aux deux conditions suivantes: (1) le dispositif ne doit pas produire de brouillage préjudiciable, et (2) ce dispositif doit accepter tout brouillage reçu, y compris un brouillage susceptible de provoquer un fonctionnement indésirable.

Important Note for mobile device use

Radiation Exposure Statement: This equipment complies with IC radiation exposure limits set forth for an uncontrolled environment. This equipment should be installed and operated with minimum distance 20cm between the radiator & your body.

Note Importante pour l'utilisation de dispositifs mobiles

Déclaration d'exposition aux radiations:

Cet équipement est conforme aux limites d'exposition aux rayonnements IC établies pour un environnement non contrôlé. Cet équipement doit être installé et utilisé avec un minimum de 20 cm de distance entre la source de rayonnement et votre corps.

Europe – EU Declaration of Conformity

This device complies with the essential requirements of the EMC Directive 2004/108/EC. The following test methods have been applied in order to prove presumption of conformity with the essential requirements

of the EMC Directive 2004/108/EC:

- EN 60950-1:2006/AC:2011: Information technology equipment - Safety - Part 1: General requirements
- EN 55022: 2010/AC:2011: Information technology equipment - Radio disturbance characteristics
 - Limits and methods of measurement
- EN 55024: 2010: Information technology equipment - Immunity characteristics - Limits and methods of measurement

Česky [Czech]	LaCie tímto prohlašuje, že tento direct attached storage device je ve shodě se základními požadavky a dalšími příslušnými ustanoveními směrnice 2004/5/ES.
Dansk [Danish]	Undertegnede LaCie erklærer herved, at følgende udstyr direct attached storage device overholder de væsentlige krav og øvrige relevante krav i direktiv 2004/5/EF.
Deutsch [German]	Hiermit erkläre LaCie, dass sich das Gerät direct attached storage device in Übereinstimmung mit den grundlegenden Anforderungen und den übrigen einschlägigen Bestimmungen der Richtlinie 2004/5/EG befindet.
Eesti [Estonian]	Käesolevaga kinnitab LaCie seadme direct attached storage device vastavust direktiivi 2004/5/EÜ põhinõuetele ja nimetatud direktiivist tulenevatele teistele asjakohastele sätetele.
English	Hereby, LaCie, declares that this direct attached storage device is in compliance with the essential requirements and other relevant provisions of Directive 2004/5/EC.
Español [Spanish]	Por medio de la presente LaCie declara que el direct attached storage device cumple con los requisitos esenciales y cualesquiera otras disposiciones aplicables o exigibles de la Directiva 2004/5/CE.
Ελληνική [Greek]	ΜΕ ΤΗΝ ΠΑΡΟΥΣΑ LaCie ΔΗΛΩΝΕΙ direct attached storage device ΣΥΜΜΟΡΦΩΝΕΤΑΙ ΠΡΟΣ ΤΙΣ ΟΥΣΙΩΔΕΙΣ ΑΠΑΙΤΗΣΕΙΣ ΚΑΙ ΤΙΣ ΛΟΙΠΕΣ ΣΧΕΤΙΚΕΣ ΔΙΑΤΑΞΕΙΣ ΤΗΣ ΟΔΗΓΙΑΣ 2004/5/ΕΚ.
Français [French]	Par la présente LaCie déclare que l'appareil direct attached storage device est conforme aux exigences essentielles et aux autres dispositions pertinentes de la directive 2004/5/CE.
Italiano [Italian]	Con la presente LaCie dichiara che questo direct attached storage device è conforme ai requisiti essenziali ed alle altre disposizioni pertinenti stabilite dalla direttiva 2004/5/CE.
Latviski [Latvian]	Ar šo LaCie deklarē, ka direct attached storage device atbilst Direktīvas 2004/104/EK būtiskajām prasībām un citiem ar to saistītajiem noteikumiem.
Lietuvių [Lithuanian]	Šiuo LaCie deklaruoja, kad šis direct attached storage device atitinka esminius reikalavimus ir kitas 2004/104/EB Direktyvos nuostatas.
Nederlands [Dutch]	Hierbij verklaart LaCie dat het toestel direct attached storage device in overeenstemming is met de essentiële eisen en de andere relevante bepalingen van richtlijn 2004/104/EG.
Malti [Maltese]	Hawnhekk, LaCie, jiddikjara li dan direct attached storage device jikkonforma mal-htigijiet essenzjali u ma provvedimenti oħrajn rilevanti li hemm fid-Direttiva 2004/104/EC.

Magyar [Hungarian]	Alulírott, LaCie nyilatkozom, hogy a direct attached storage device megfelel a vonatkozó alapvető követelményeknek és az 2004/104/EC irányelv egyéb előírásainak.
Polski [Polish]	Niniejszym LaCie oświadcza, że direct attached storage device jest zgodny z zasadniczymi wymogami oraz pozostałymi stosownymi postanowieniami Dyrektywy 2004/104/EC.
Português [Portuguese]	LaCie declara que este direct attached storage device está conforme com os requisitos essenciais e outras disposições da Directiva 2004/104/CE.
Slovensko [Slovenian]	LaCie izjavlja, da je at direct attached storage device v skladu z bistvenimi zahtevami in ostalimi relevantnimi določili direktive 2004/104/ES.
Slovensky [Slovak]	LaCie týmto vyhlasuje, že direct attached storage device spĺňa základné požiadavky a všetky príslušné ustanovenia Smernice 2004/104/ES.
Suomi [Finnish]	LaCie vakuuttaa täten että direct attached storage device tyyppinen laite on direktiivin 2004/104/EY oleellisten vaatimusten ja sitä koskevien direktiivin muiden ehtojen mukainen.
Svenska [Swedish]	Härmed intygar LaCie att denna direct attached storage device står i överensstämmelse med de väsentliga egenskapskrav och övriga relevanta bestämmelser som framgår av direktiv 2004/104/EG.

China RoHS



China RoHS 2 refers to the Ministry of Industry and Information Technology Order No. 32, effective July 1, 2016, titled Management Methods for the Restriction of the Use of Hazardous Substances in Electrical and Electronic Products. To comply with China RoHS 2, we determined this product's Environmental Protection Use Period (EPUP) to be 20 years in accordance with the Marking for the Restricted Use of Hazardous Substances in Electronic and Electrical Products, SJT 11364-2014.

中国 RoHS 2 是指 2016 年 7 月 1 日起施行的工业和信息化部令第 32 号“电力电子产品限制使用有害物质管理办法”。为了符合中国 RoHS 2 的要求，我们根据“电子电气产品有害物质限制使用标识”(SJT 11364-2014) 确定本产品的环保使用期 (EPUP) 为 20 年。

產品名稱：外接式固態硬碟，型號: LRDMU05		Product Name: LaCie 1big Dock SSD Pro, Model: LRDMU05				
單元 Unit	限用物質及其化學符號			Restricted Substance and its chemical symbol		
	鉛 (Pb)	汞 (Hg)	鎘 (Cd)	六價鉻 (Cr ⁺⁶)	多溴聯苯 (PBB)	多溴二苯醚 (PBDE)
固態驅動器 SSD	—	○	○	○	○	○
外接硬盤印刷電路板 Bridge PCBA	—	○	○	○	○	○
電源 (如果提供) Power Supply (if provided)	—	○	○	○	○	○
傳輸線材 (如果提供) Interface cable (if provided)	—	○	○	○	○	○
其他外殼組件 Other enclosure components	○	○	○	○	○	○

備考 1. “○” 係指該項限用物質之百分比含量未超出百分比含量基準值。
Note 1. “○” indicates that the percentage content of the restricted substance does not exceed the percentage of reference value of presence.

備考 2. “—” 係指該項限用物質為排除項目。
Note 2. “—” indicates that the restricted substance corresponds to the exemption.

Taiwan RoHS

Taiwan RoHS refers to the Taiwan Bureau of Standards, Metrology and Inspection's (BSMI's) requirements in standard CNS 15663, Guidance to reduction of the restricted chemical substances in electrical and electronic equipment. Beginning on January 1, 2018, Seagate products must comply with the “Marking of presence” requirements in Section 5 of CNS 15663. This product is Taiwan RoHS compliant. The following table meets the Section 5 “Marking of presence” requirements.

台灣RoHS是指台灣標準局計量檢驗局(BSMI)對標準CNS15663要求的減排電子電氣設備限用化學物質指引。從2018年1月1日起，Seagate產品必須符合CNS15663第5節「含有標示」要求。本產品符合台灣RoHS。下表符合第5節「含有標示」要求。

產品名稱：外接式固態硬碟，型號: LRDMU05

Product Name: LaCie 1big Dock SSD Pro, Model: LRDMU05

單元 Unit	限用物質及其化學符號 Restricted Substance and its chemical symbol					
	鉛 (Pb)	汞 (Hg)	鎘 (Cd)	六價鉻 (Cr ⁺⁶)	多溴聯苯 (PBB)	多溴二苯醚 (PBDE)
固態驅動器 SSD	—	○	○	○	○	○
外接硬盤印刷電路板 Bridge PCBA	—	○	○	○	○	○
電源 (如果提供) Power Supply (if provided)	—	○	○	○	○	○
傳輸線材 (如果提供) Interface cable (if provided)	—	○	○	○	○	○
其他外殼組件 Other enclosure components	○	○	○	○	○	○

備考 1. “○” 係指該項限用物質之百分比含量未超出百分比含量基準值。

Note 1. “○” indicates that the percentage content of the restricted substance does not exceed the percentage of reference value of presence.

備考 2. “—” 係指該項限用物質為排除項目。

Note 2. “—” indicates that the restricted substance corresponds to the exemption.