

avocor



AVE-5530
User Manual

TABLE OF CONTENTS

Compliance Information	3
Declaration of Conformity	3
FCC Part 15.....	Error! Bookmark not defined.
Caution.....	3
Industry Canada (ICES-003).....	3
Product Disposal	3
Disposal of Old Electrical and Electronic Equipment.....	4
Introduction.....	5
About This Manual.....	5
Textual Conventions	5
Graphic Conventions.....	6
What's in the Box?	7
Specifications.....	8
The display, at a glance	9
Front Panel.....	9
Back Panel.....	10
Front Panel Interface	11
Front Panel Guest Inputs	12
Rear Source Inputs.....	13
Bottom-Rear Panel Inputs.....	14
Installation.....	15
Ambient Considerations	16
Ambient Light.....	16
Ambient Temperature	16
Ventilation	16
Mounting the Display.....	17
Stationary Stands	17
Rolling Cart.....	18
Wall Mount	19

Peripheral Connections..... 20

 Front Ports 20

 Rear-Side Ports..... 21

 Lower Ports 22

OPS Module 23

 OPS Installation Step-by-Step 23

Remote Control..... 25

 Remote Control Batteries 26

Operation 27

 The Home Screen 27

 The UiQ 28

 Display Settings Tips 30

 Network Settings Tips 32

 Update System – Firmware..... 38

External Control 39

 RS232 Connection and Port Configuration 39

 TCP/IP Control Configuration..... 39

 Command and Response Format..... 39

 Serial Command List 40

Warranty Information..... 45

COMPLIANCE INFORMATION

Declaration of Conformity

Avocor hereby declares that the following Product Model Number:

AVE-5530

conforms to the provisions of the following regulations:

- FCC:
 - FCC CFR Title 47 Part 15 Subpart B Class A, CISPR22
 - ANSI C63.4
 - ICES-003
- CE:
 - EN55032
 - EN55035
 - EN61000-3-2
 - EN61000-3-3
- cULus:
 - UL 62368-1
 - CAN/CSA-C22.2 No. 62368-1
- CB:
 - IEC 62368-1
- EEL
- Energy Star V8

CAUTION

Any changes or modifications not expressly approved by the grantee of this device could void the user's authority to operate the equipment.

Industry Canada (ICES-003)

CAN ICES-3 (B)/NMB-3(B)

Product Disposal

The Product contains small amounts of tin, lead, and/or mercury. Disposal of these materials may be regulated due to environmental considerations.

Disposal of Old Electrical and Electronic Equipment

Applicable throughout the European Union and other European countries with separate collection programs



This symbol, found on your product or on its packaging, indicates that this product should not be treated as household waste when you wish to dispose of it. Instead, it should be handed over to an applicable collection point for the recycling of electrical and electronic equipment. By ensuring that this product is disposed of correctly, you will help prevent potential negative consequences to the environment and human health, which could otherwise be caused by inappropriate disposal of this product.

The recycling of materials will help to conserve natural resources. This symbol is only valid in the European Union. If you wish to discard this product, please contact your local authorities or dealer and ask for the correct method of disposal.

INTRODUCTION

Your new Avocor AVE-5530 display is an ultra-high definition interactive touch display supporting full range 4K@60hz resolution, up to 20 simultaneous touch points, multiple source inputs for your computers and peripheral devices, and our new intuitive **UiQ**.

Our AVE-5530 display follows our agnostic approach to interactive displays: they are compatible with a wide range of hardware and software, making it a great addition to any interactive meeting-room solution.

Whether you need a virtual meeting space for your conference room, or a powerfully adaptive whiteboard or presentation hub for your classroom, the Avocor AVE-5530 will exceed your expectations.

About This Manual

This user manual was written to help you get the most out of your display.

In addition to detailed descriptions of the display and its features, this manual will guide you through the installation and setup processes and provide tips, tricks, and best practices on how best to utilize the display.

We make every effort to ensure that this manual is accurate as of the date it was printed. However, it may require periodic updating due to ongoing product improvements and customer feedback. Find the latest version of our manuals at Avocor.com.

Textual Conventions

The following textual conventions are used in this manual to denote certain actions or information for clarification purposes. Here are the details:

- Remote control and display keypad controls are set in CAPS. For example, "Press OK on the remote control to accept your changes."
- Menus in the OSD and computer interface are in **bold**. The ">" symbol is used to help denote submenu navigation. For example, "Open **Display > Picture > Advanced Settings** to adjust various picture settings."
- Keyboard keys with functional names are capitalized and set in <Angle Brackets>. For example, "press <Enter> to make your selection."
- In addition to the above, underlining, *italics*, or a combination of the two are used periodically to help emphasize key points in the text of this manual.

Graphic Conventions

The following symbols appear throughout this manual to emphasize key points. Keep these in mind not only to benefit from their advice, but also to avoid problems with the display or personal injury.



TIP

Highlights helpful guidelines and best practices for using certain features.



NOTE

Provides supplemental information and emphasize text of special significance.



CAUTION

Alerts that given actions may degrade the performance of the display or cause a malfunction.



WARNING

Alert that a given action may result in damage to equipment or personal injury.



DANGER

Alert that a given action may cause serious personal injury or death.

WHAT'S IN THE BOX?

- Avocor AVE-5530, 55" Interactive Display
- Quick Start Guide with QR code
- Remote Control & Batteries
- (2) Touch Stylus 3mm
- Power Cables
 - US Cable 2m
 - UK Cable 2m
 - European Cable 2m
- (1) HDMI cable 3m
- (1) USB-C cable 1.5m
- (1) USB-A 3.0 cable 3m
- Cleaning Cloth

SPECIFICATIONS

AVE-5530	
Diagonal Size (Inches)	55
Backlight	Backlit LED
Aspect Ratio	16:9
Resolution	3840 x 2160 @ 60Hz
Response Time	8 ms
Brightness	370 (cd/m ²)
Contrast Ratio	4000:1
Viewing Angle	178°/178
Supported Colors	30 Bit Deep Color
Display Orientation	Landscape
Touch System	
Touch	Up to 20 Point Avocor Intelligent Touch – Supports 1 fine tip stylus
Glass	2mm Bonded, Anti-Glare, Anti-Fingerprint Glass
Supported OS	Windows 8 & 10; Mac OSX; Linux
Connectivity	
Guest Inputs	1x HDMI 2.0, 1x USB-B Touch 3.0, 1x USB-A 3.0 Hub, 1x Type C
Side Inputs	2x HDMI 2.0, 1x DisplayPort 1.2, 1x USB- Touch 3.0
Other Inputs	1x USB-A 3.0, 1x USB Service Port, HDMI Out (4K@60Hz)
Audio	1x 3.5mm Audio Out, 1x Optical (SPDIF)
Control	1x LAN Ethernet (RJ-45) in, 1x LAN Ethernet (RJ-45) out, 1x RS232 (DB9 Female)
OPS Slot	Yes, 3840 x 2160 @ 60Hz
Audio	
Built-in Speakers	2x 15W – Forward Facing
Display Functions	
Auto-source detection, Source Preview, Wireless Presentation, Blank, Freeze	
Physical Specifications	
Product Dimensions	1286 x 78.4 x 802 mm / 50.6 x 3.1 x 31.6 in
Shipping Dimensions	1415 x 270 x 932 mm / 55.7 x 10.6 x 36.7 in
Weight	Net: 32.5 kg / 71.65 lbs Gross: 44.5 kg / 98.11 lbs
Wall Mount (VESA)	400 x 600 mm
Handles	2
Power	
Power Supply	AC100 – 240V (Worldwide), 50/60Hz
Max Power Consumption	<220W
Standby	≤0.5W
Environmental	
Operating Temperature	0°C ~ 40°C / 32° F ~ 104° F
Storage Temperature	-20° C ~ 60° C / -4° F ~ 140° F
Humidity	20% ~ 80%
Warranty	
Global	3 Year RTB with optional upgrades available (contact your reseller for more info)

THE DISPLAY, AT A GLANCE

The following diagrams depict the front, side, and bottom panels of the display. The physical interface and connections are labeled, and then described in the tables that follow.

Front Panel

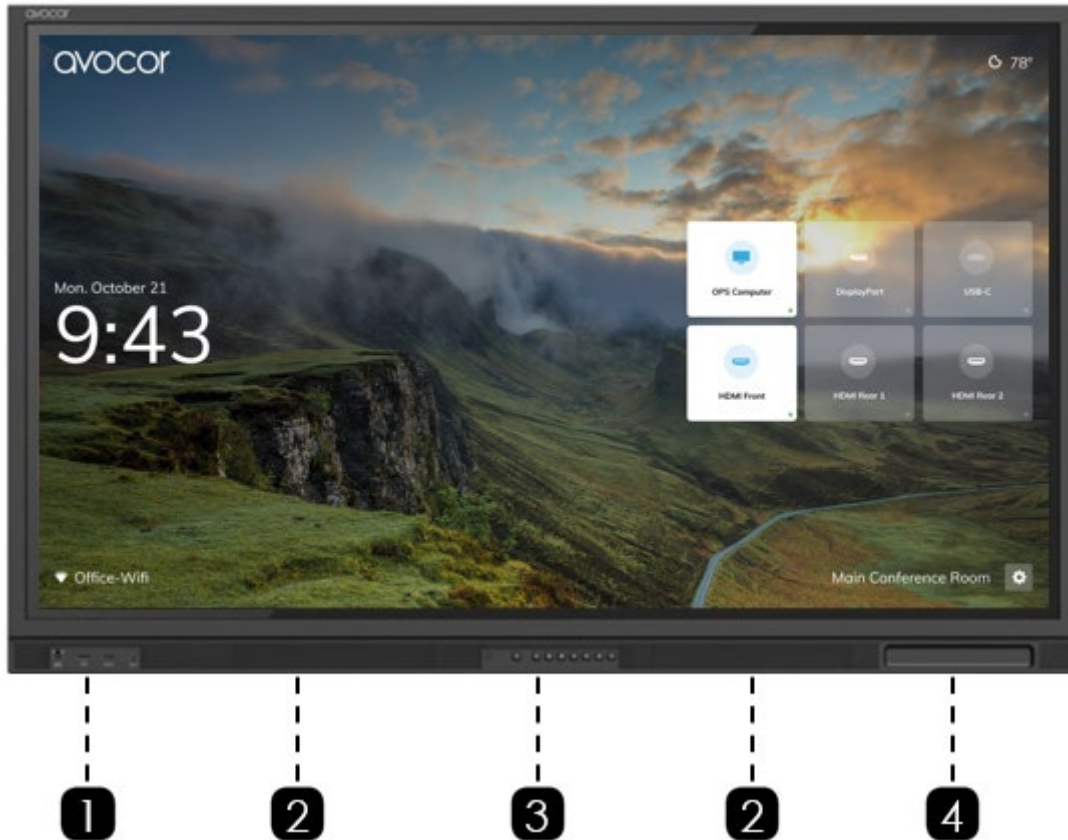

1	Front Panel Interface/Guest Inputs	HDMI 2.0, USB Type C, Touch USB 3.0, USB 3.0 (Accessory Port)
2	Front Panel Speakers	2 X 15W; 12V
3	Front Panel Interface	See Page 9 for more details.
4	Pen Tray	Magnetized pen storage!

Back Panel

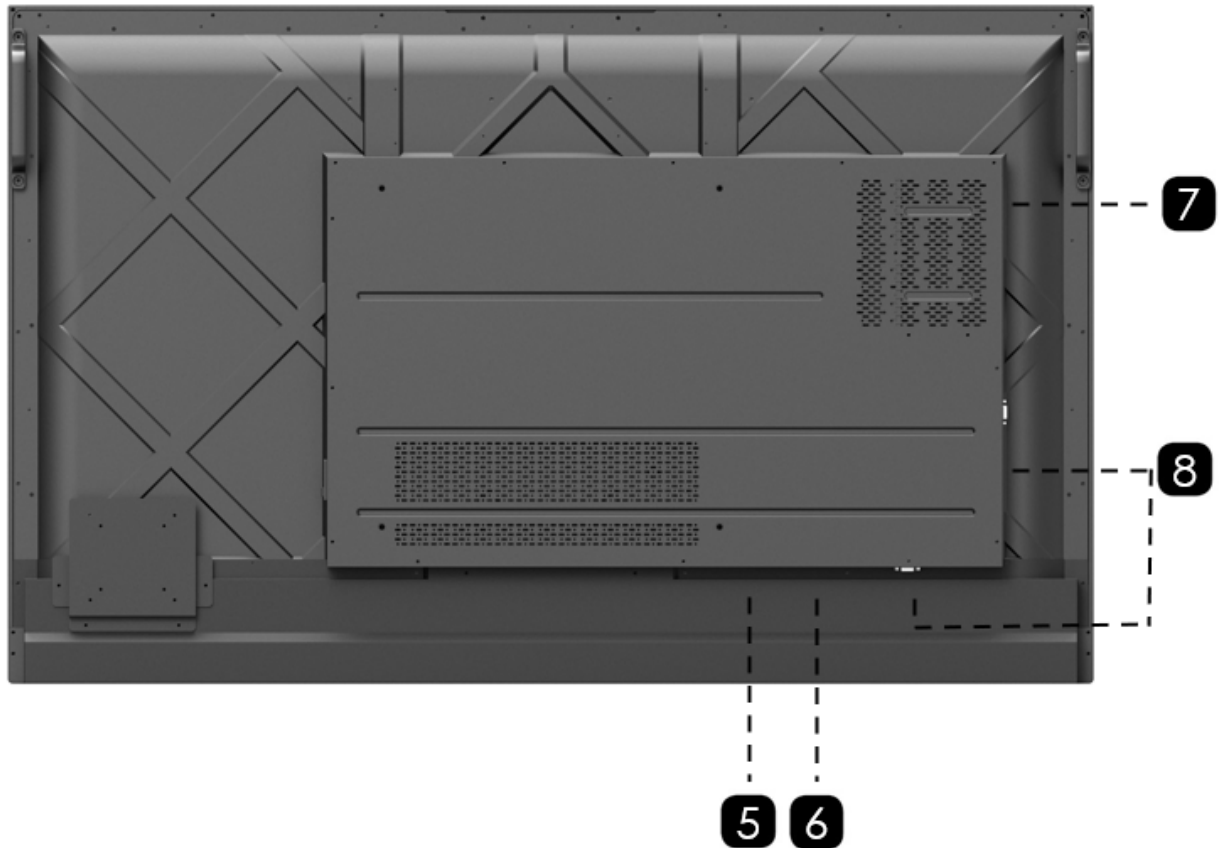

5	Main Power Switch	A/C Rocker Switch; toggles all power to the display.
6	Power Cord Socket	Three-pin A/C Jack.
7	OPS Slot	TX25A-80P standard OPS input; compatible with non-standard OPS-C structure.
8	Rear Source Inputs	DisplayPort, HDMI 1, HDMI 2, USB Touch 3.0, USB 2.0 (Accessory), Audio Line Out, VGA Audio, VGA, USB 3.0 (Accessory), HDMI Out.

Front Panel Interface



[FPO]

1	LED Two-color indicator	Indicates the power status of the display.
2	Light inlet window	Ambient visible light detector.
3	Power	Turn the display on/off.
4	Source	Switch sources.
5	Menu	Open <i>UiQ Settings</i> .
6	Home	Access the <i>Home</i> screen.
7	Volume -	Short press to reduce one level of volume; Long press, continue to reduce the volume.
8	Volume +	Short press to increase the volume; Long press, continue to increase the volume.
9	Freeze	"Freeze" the active image on the display; press again to resume normal operation.
10	Blank	Disables the backlight.

Front Panel Guest Inputs

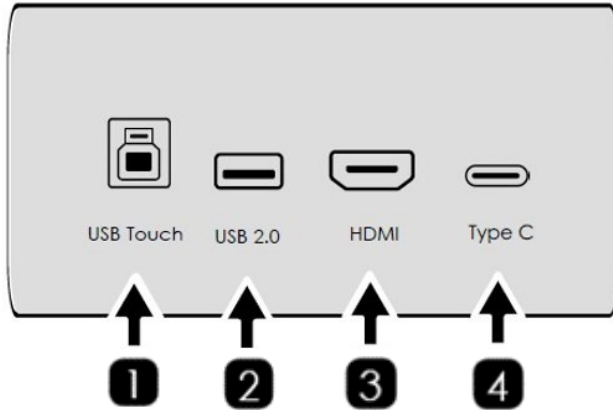

1	USB Touch	USB Touch 3.0 Guest Input.
2	USB 2.0	USB Accessory Input.
3	HDMI	HDMI Guest Input.
4	Type C	USB Type C Guest Input for video and Touch

Rear Source Inputs

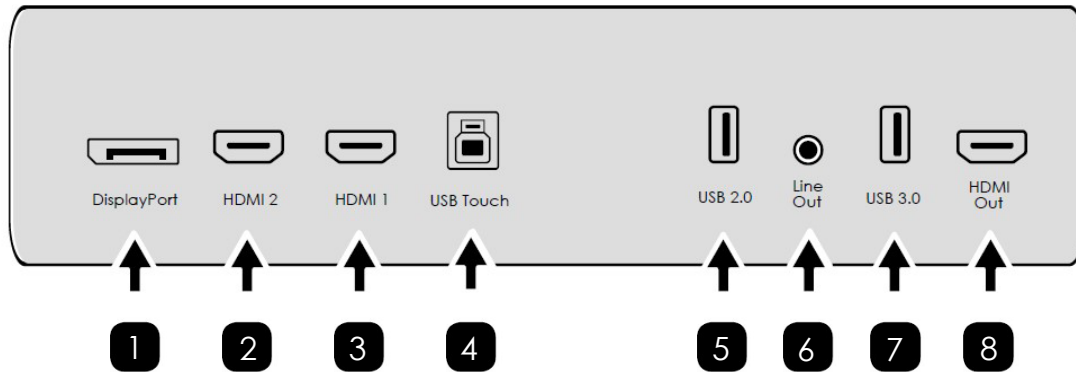

1	DP	DP1.2 & HDCP2.2.
2	HDMI1	HDMI2.0B & HDCP2.2.
3	HDMI2	HDMI2.0B & HDCP2.2.
4	USB Touch	USB 3.0 Type B for touch control.
5	USB 2.0	USB 2.0 accessory port.
6	Line out	3.5mm Analog audio output (no mic).
7	USB 3.0	USB 3.0 accessory port
8	HDMI Out	HDCP compliant HDMI out.

Bottom-Rear Panel Inputs

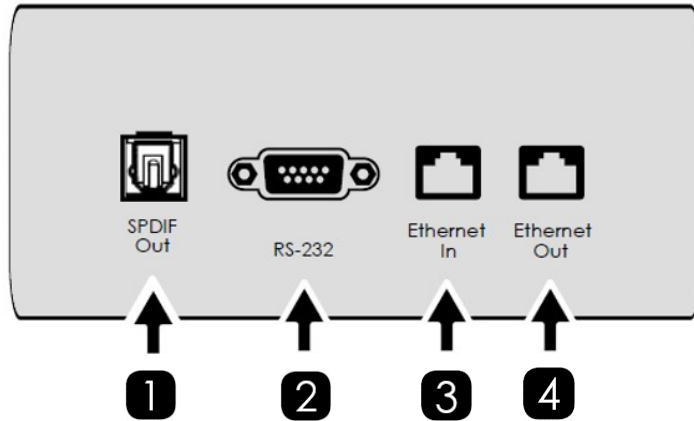

1	SPDIF Out	Sony/Phillips Digital Interface	Connect external and digital powered speakers, or an audio receiver or amplifier.
2	RS232	DB9 Female Input	For interfacing with a PC or automation/control system.
3	Ethernet In	RJ45 Input	Lan In, 10/100Mbps.
4	Ethernet Out	RJ45 Output	Lan Out, 10/100Mbps.

INSTALLATION

 Please read the following precautions carefully before installing your new Avocor AVE-5530 display. Failure to comply may result in damage to the display and equipment and may result in personal injury or death.

- DO NOT install the display in a high temperature environment or near any apparatus that produce heat.
 - This may cause damage to the panel and equipment. It may also cause personal injury due to electrical shock resulting from overheating.
- DO NOT install the display in a high humidity environment or an environment where it can come into contact with water.
 - This may cause damage to the panel and equipment. It may also cause personal injury due to electrical shock resulting from overheating.
- DO NOT overload outlets or cables beyond their electrical capacity.
- DO NOT insert the power plug into an outlet rated outside the range of 100~240V A/C.
- DO NOT insert the power plug into a damaged outlet.
- DO NOT use a worn or damaged A/C power cable.
- DO NOT use an improper or mismatched A/C power cable.
- DO NOT place the display on an unstable shelf or surface.
- DO NOT place objects on the display as instructed below:
 - Do not cover the vents on the display.
 - Do not allow liquid or small particles to enter the vents or other parts of the display.
 - Do not put heavy objects on the display.
- Please allow room between the wall and the display panel to maintain proper ventilation and avoid overheating.
- Make sure you use the handles on the back of the display while lifting or moving the display, to avoid touching the front panel during the move.
- When unpacking, and carrying the display please follow these guidelines:
 - 2 people are needed for displays up to 55"

Before installing, please make sure the wall is strong enough to hold the necessary weight of the display and the mount.

Ambient Considerations

Environmental and ambient factors play a considerable role in determining your viewing experience and the functional operation of the display. Make sure to follow these guidelines carefully to get the most out of your display.

AMBIENT LIGHT

For the best viewing experience, make sure to minimize or remove light sources directed at the screen, especially sunlight.

Any direct light may make images on the screen appear washed out and less vibrant, and direct sunlight may even affect touch control operation.

AMBIENT TEMPERATURE

Maintain the ambient temperature of the room at a consistent level. This will ensure that the display continues to operate smoothly.

Do not place the display near heat sources or air conditioning vents, and do not operate or store the display in temperatures above 40 degrees Celsius (104 degrees Fahrenheit).

VENTILATION

The display should maintain a proper operating temperature provided that the ambient temperature is not too high, and that the vents on the display have enough room to disperse any heat emanating from the display.

⚠ Do not block the vents on the display! Leave a space of about 4 inches between all sides of the display and surrounding walls or objects, as shown in the figure, below.

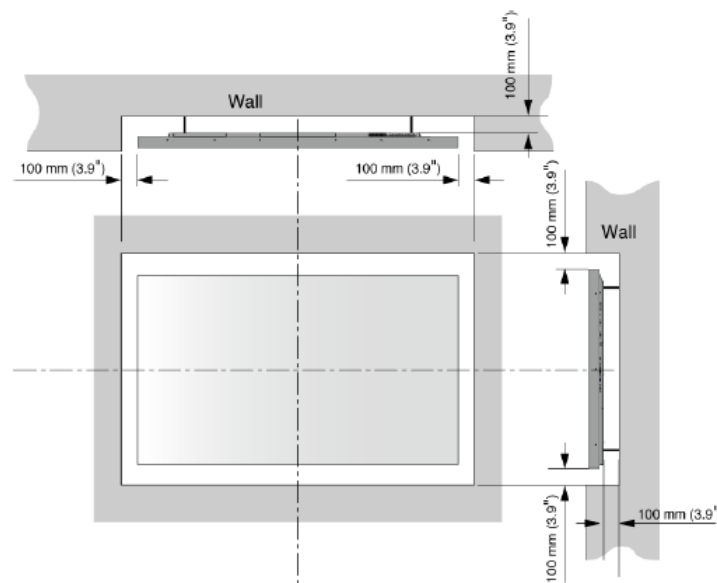

Mounting the Display

The three primary types of mounting solutions are Stationary Stands, Rolling Carts, and Wall Mounts. This chapter will examine each type and how they might fit into your installation.



NOTE

- Leave mounting to the installation specialists.
- Always make sure that your stand, or mount/wall is rated to hold the weight of your display.
- Make sure that the surface you place the mount or stand upon can support the weight of your display.
- Make sure the tilt degree of the display does not exceed 2°.
- Always get help when moving or mounting the display.
 - 2 people are needed for displays up to 55"

STATIONARY STANDS

Stationary stands can come in the form of tabletop stands or floor stands. These stands are worthwhile for either permanent or temporary installations; they are less mobile than rolling carts but are a bit more flexible than wall mounts.



WARNING

- If you decide to implement a tabletop stand, make sure that the table or surface you plan to place the display on can support the weight of both the display and the stand.

ROLLING CART

As the most mobile of mounting solutions, the rolling cart is perfect for those who want a flexible setup that can be taken to different rooms.

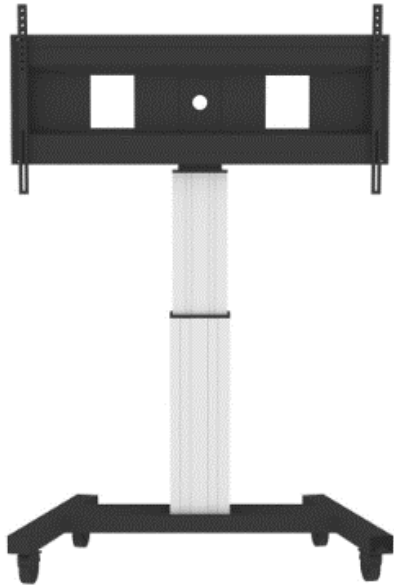

WARNING

- At least two people are needed to move a rolling cart with a mounted display.
- When moving your cart, make sure that you have a clear path to your destination and be sure to warn other people around you.

WALL MOUNT

Though immobile and possibly the most time-consuming install, wall mounts benefit from the fact that they take up much less space than their counterparts. This is a great option for those who want a permanent sleek-looking setup, especially if extra time is taken to route any cabling through the wall.



WARNING

- The wall must be capable of supporting a redundant weight factor of 3x the weight of the display or be reinforced to support a 3x redundant weight factor.
- Use only approved wall-mounting kits; talk to the installation experts for their recommendations and advice.

Peripheral Connections

Your Avocor AVE-5530 display supports connections to multiple peripheral devices, from computers, to wireless presentation systems, to external control systems.

The below diagrams demonstrate how to connect your peripherals for the best possible results.

FRONT PORTS

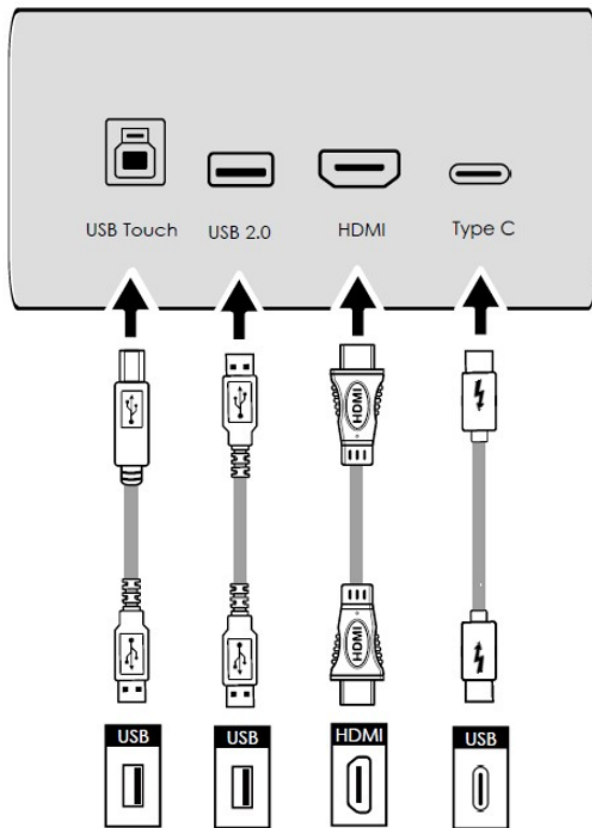

The front ports on your AVE-5530 display are great for a plug-and-play session for up to two devices and an accompanying USB 2.0 compatible accessory. The Type C port will support both touch and video. If using the HDMI port for video, the USB Touch input is required to enable touch control.

REAR-SIDE PORTS

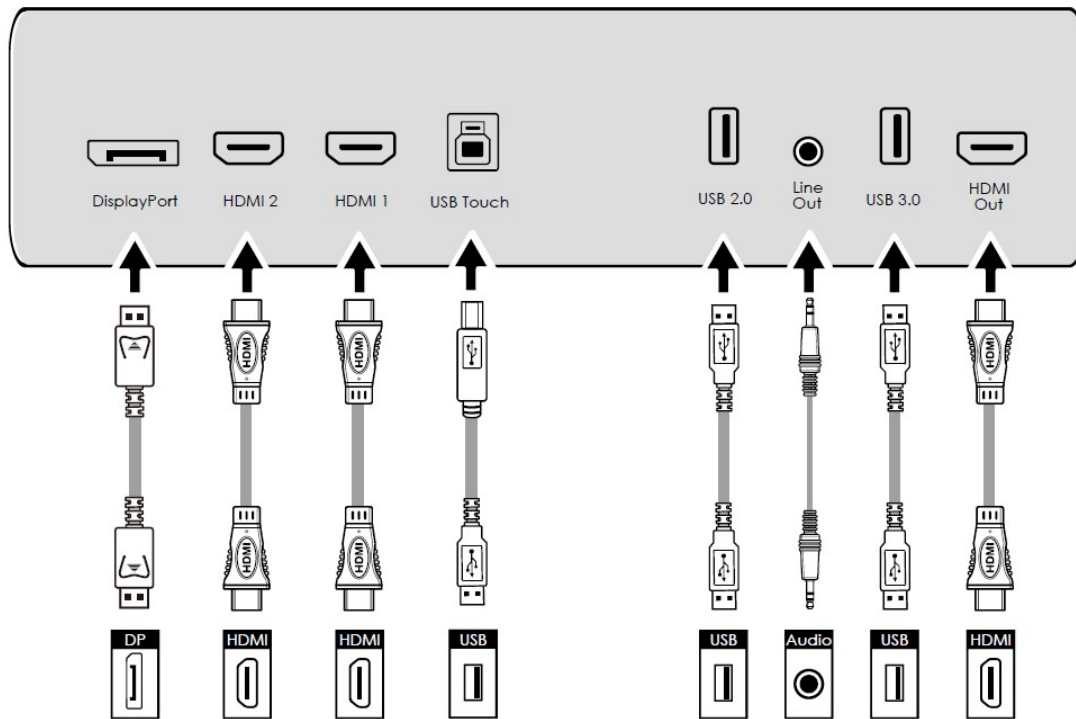

The preferred method to properly connect a device to the panel is to connect your device to one of the video inputs via HDMI or DisplayPort and connect your USB-A—USB-A cable to your device and the USB Touch input.

LOWER PORTS

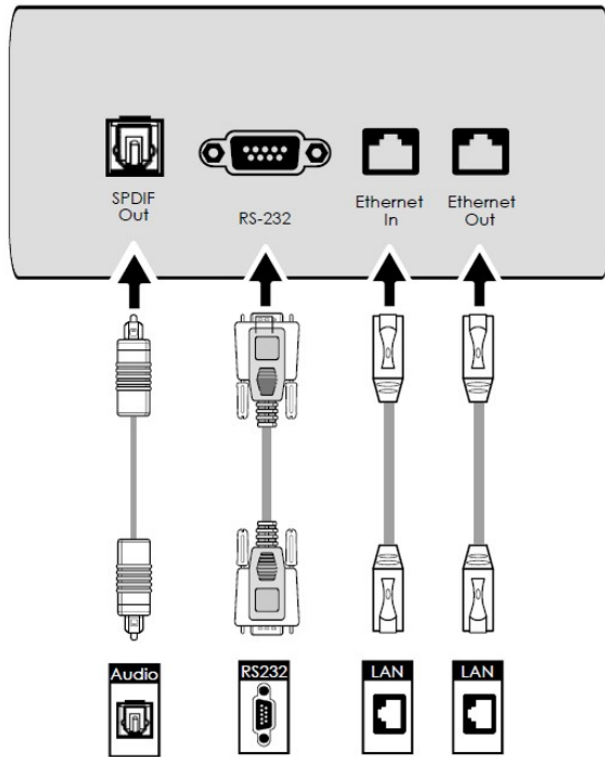

This is where you can integrate your AVE-5530 with your rooms audio, network, and control/automation systems. **Use a straight through DB9 connector to properly connect your control system to the RS-232 port on the display.**

OPS Module

Your Avocor AVE-5530 is compatible with any Open Pluggable Standard (OPS) computer module. Avocor offers its own OPS PC module, which is optimized for the display, for a separate purchase.



Installing an Avocor OPS module is a relatively simple process, but one that still needs a level of care and attention. Improper installation may cause malfunction or even damage the OPS module or the OPS Slot-Connector on the display. *Please follow these instructions carefully.*

OPS INSTALLATION STEP-BY-STEP

- I. Turn off the main power switch on the display.
- II. **Remove the OPS slot shield** on the display input panel

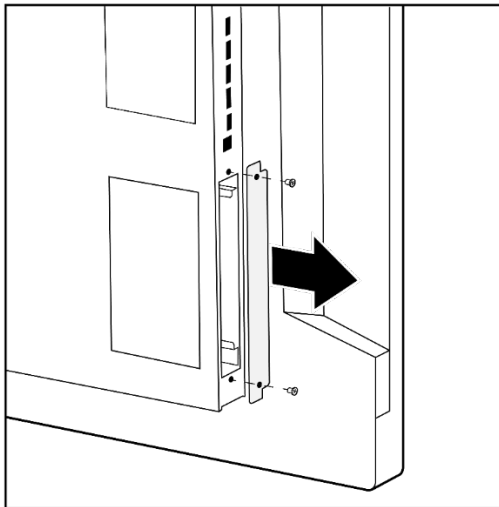

- II. **Install the Avocor OPS computer** by carefully sliding it into the OPS slot as pictured below.

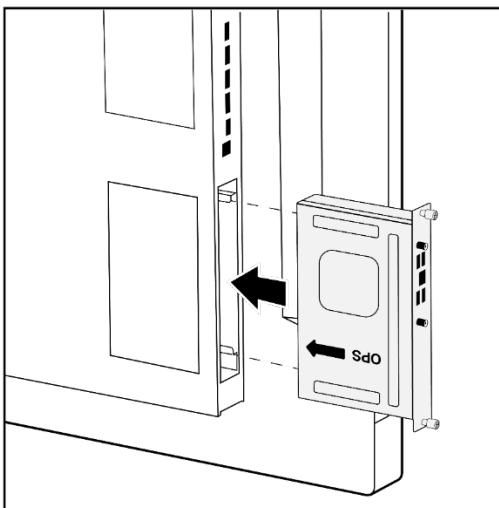



If installing an Avocor OPS module, the "OPS ==>" imprint should be upside down and facing the back panel of the display. If there is no imprint, then the small square fan vent should be facing the same direction as the back panel.

III. **Secure the OPS computer into the slot** using the screws that were removed earlier

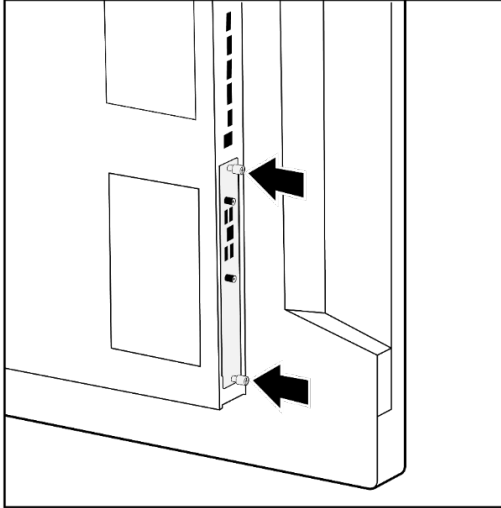

That's it! Your OPS should be ready to go. Turn the main power of the display back on and hit the power button on the OPS module to begin operation.

Remote Control

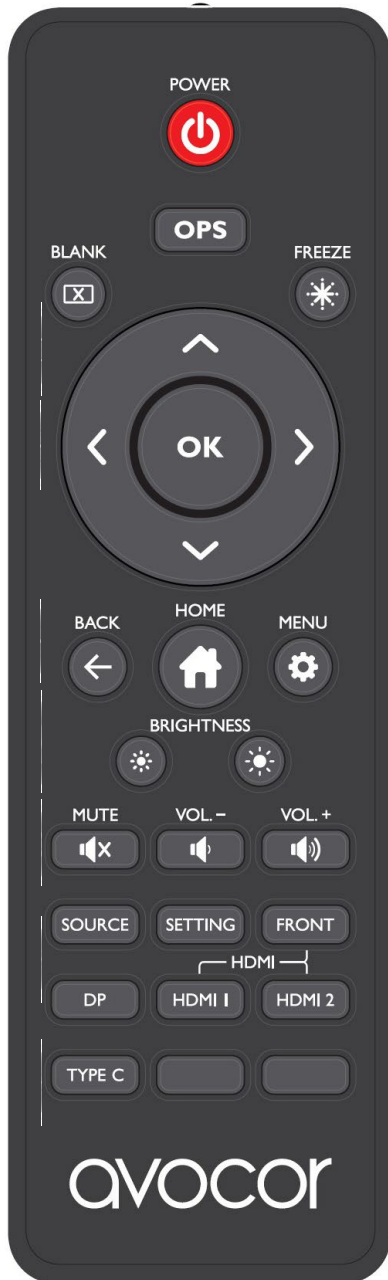

	POWER	Power on/off the display
	OPS	Navigate to the OPS input
	BLANK	Blanks the display. Press again to restore.
	FREEZE	Freezes the display. Press again to restore.
	OK/Direction keys	Menu navigation and selection
	RETURN	Go back to the previous menu
	HOME	Navigate to the UiQ home screen
	MENU	Open the OSD menu
	BRIGHTNESS -	Decreases the Brightness
	BRIGHTNESS +	Increases the Brightness
	MUTE	Toggle Mute on/off
	VOL. -	Decreases the volume
	VOL. +	Increases the volume
	SOURCE	Open the Source selection menu
	SETTING	Open display Settings
	FRONT	Switch to the HDMI Front input source
	DP	Switch to the DisplayPort input source
	HDMI 1	Switch to the HDMI 1 input source
	HDMI 2	Switch to the HDMI 2 input source
	Type C	Switch to the Type C input source

REMOTE CONTROL BATTERIES

To install batteries in the remote control:

1. Press down the tab on the cover plate and pull the cover plate up.
2. Insert the included batteries. Ensuring that the polarities correctly match the (+) and (-) markings inside the battery compartment.
3. Insert the lower tab of the cover into the opening, and press down the cover until it clicks in place.



Notes on Batteries

- Please only use approved AAA type batteries.
- Do not mix an old battery with a new one or different types of batteries.
- If you will not use the remote control for a long time, remove the batteries to avoid damage from battery leakage.
- Do not expose batteries to excessive heat such as from sunshine, fire or the like.
- Don't recharge, heat, disassemble, short or throw batteries into a fire.



Notes on Remote Control Operation

- Make sure that there is nothing obstructing the infrared beam between the remote control and the IR receiver on the display.
- If the effective range of the remote-control decreases, or it stops working, replace the batteries with new ones.
- The remote control may fail to operate if the infrared remote sensor is exposed to bright sunlight or fluorescent lighting.
- Ambient conditions may possibly impede the operation of the remote control. If this happens, point the remote control at the display, and repeat the operation.



Remote Control Sensor

The effective area of the remote control includes the vertical distance within five metres in front of the display, and the area within an angle of 30 degrees from the vertical point to the left and the right.

OPERATION

The Avocor AVE-5530 is our first smart display featuring an intuitive touch interface for source navigation and OSD menu configuration. This chapter will provide information and best practices for operating the home-screen and the various on-screen display (OSD) menu settings to help facilitate the best possible user experience.

⚠️ Precaution

Please read the following precautions regarding normal operation carefully. Failure to follow the cautionary points therein may cause damage to the screen not covered by Avocor's warranty policy.

- If you encounter a problem during installation, please contact your dealer or Avocor support for assistance. DO NOT attempt to repair or open the display yourself.
- Always avoid placing the display flat face-down or face-up. DO NOT attempt to use the display lying flat on its back at any time.
- DO NOT set a static (non-moving) image on the display for an extended period of time, as this may cause image retention or "burn-in" which is not covered by warranty.
- **RECOMMENDED USAGE HOURS:**
 - Turn off the display for at least **8 hours** after every 16 hours of usage in a 24-hour period.

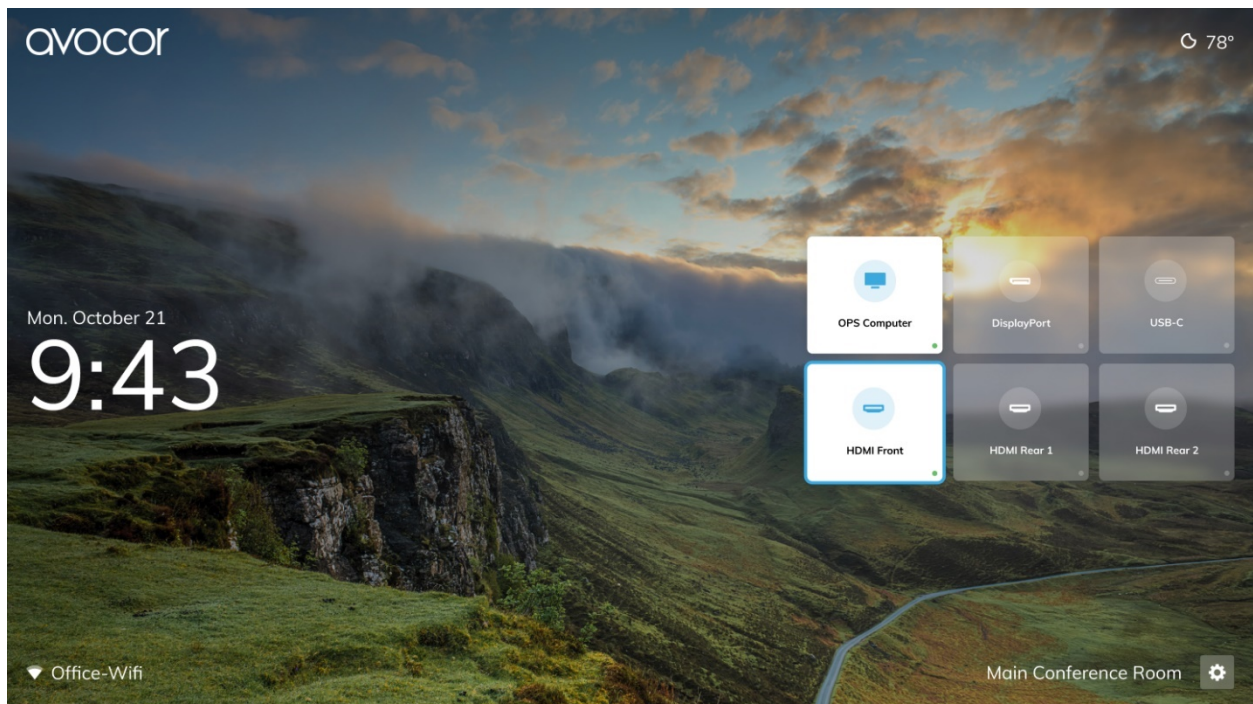

The Home Screen



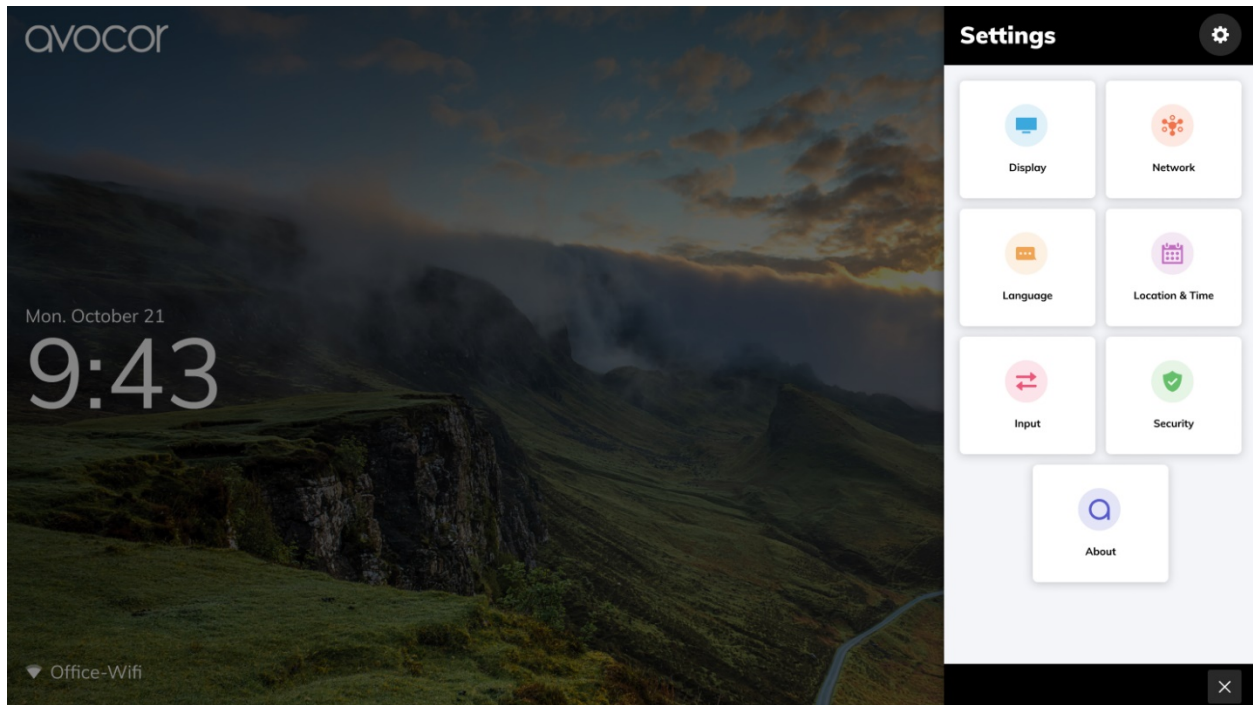

The Home Screen is the default landing page and general hub for the AVE-5530's touch interface. Here, you can configure the display's settings via the OSD and select an input source without having to use the remote control.

The UiQ



To access the **UiQ**, touch the gear icon  on the home screen, or press the **Menu**  key on your remote control.

You can access the various menu settings by touching the icon squares in this interface (see the image above). Each menu will have a  **Back** button that will return to the previous menu.

Press the  button on the bottom right of the interface or touch the **Menu**  key on the remote control again to exit the OSD menu.

Read on for more information on each menu setting.

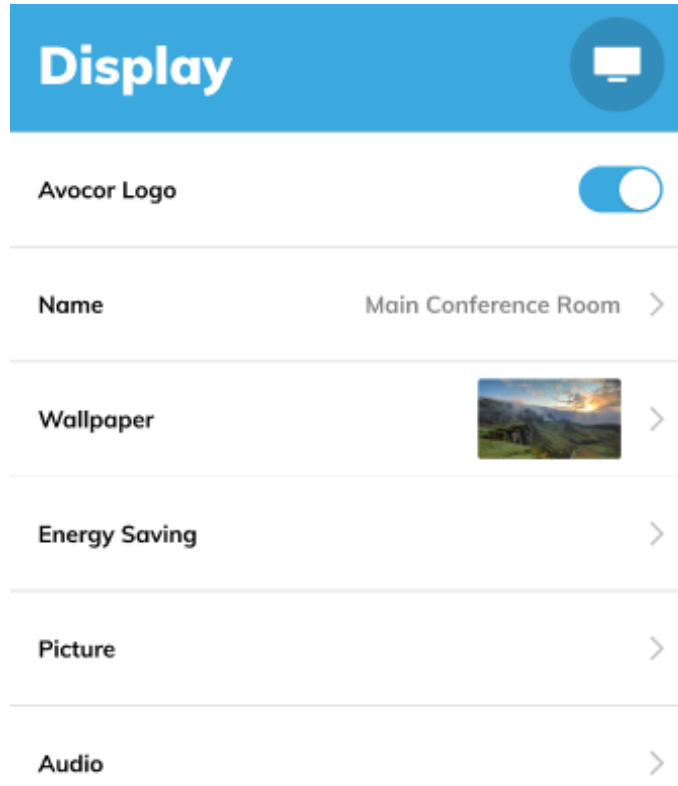

Avocor Logo	Toggles the presence of the Avocor logo on the Home Screen.
Name	Changes the name assigned to the display, which is visible on the Home Screen.
Wallpaper	Set a default or custom User Images for the Home Screen. A Slideshow option is available.
Energy Saving	Set Auto Power On/Off , Power On Time , Power Off Time , Eco Mode , OPS Always On , Display Sleep .
Picture	Set Scheme , Backlight , and Advanced Settings for the display's picture; (the Backlight's Auto feature must be disabled to adjust Advanced Settings).
Audio	Set Mute , Treble , and Bass .

DISPLAY SETTINGS TIPS

The **Display** settings submenu contains configuration options for various picture and audio settings for your AVE-5530. Navigating the menus is straightforward and intuitive, but we'll provide some tips and knowhow to help you get started.

Custom Wallpapers

The AVE-5530 already comes with some gorgeous high-resolution wallpapers, but you can easily upload your own. Just follow these steps...

- I. **Grab a USB flash drive**
- II. Open the USB flash drive's *file directory* on a computer.
- III. Create a new folder with the name **WALLPAPER**.
- IV. Save any wallpapers you want into that **WALLPAPER** folder.
- V. **On the Display** - Open **Settings>Display>Wallpaper** on the Home Screen.
- VI. Under *User Images*, touch the blank tile containing the "+" symbol (see image).
- VII. Plug your USB flash drive into the USB 2.0 accessory port on the front of the display.

That's it! Your custom wallpapers will upload automatically.

 Only 1920x1080 images or higher are supported.

 You can delete a custom wallpaper by touching the blue "x" button located on the right corner of the image preview.

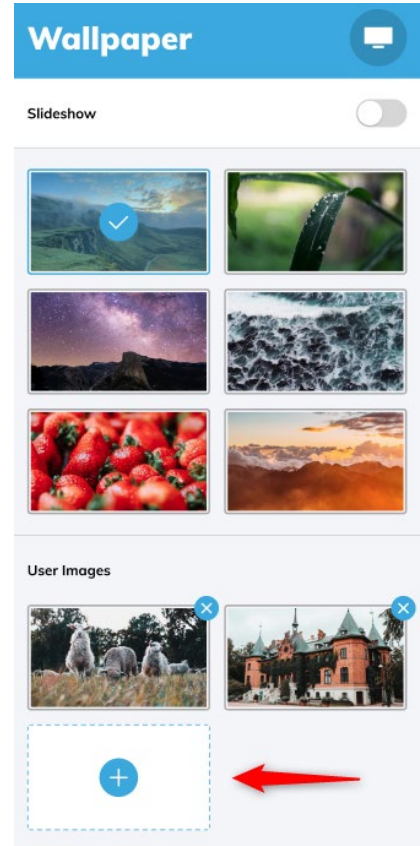

Energy Saving

This submenu provides options for helping you maximize power efficiency for your AVE-5530. Here you can...

- Schedule an **Auto Power On*** cycle for every day of the week.
- Toggle **Eco Mode** for automatic *Energy Star* rated picture settings.
- Toggle **OPS Always On** to keep the OPS port live or have it shut off with the display's normal automatic or manual power cycles.
- Set your **Display Sleep** timer to activate after a set period of inactivity.

Auto Power On*

Your automatic power schedule is divided into three items in the UIQ:

- **Auto Power On** – a slider which toggles your automatic power schedule on or off.
- **Power On Time** – sets the time your display will power on.
- **Power Off Time** – sets the time your display will power off.

Open either **Power On Time** or **Power Off Time** options and a clock wheel and seven tiles representing the days of the week will appear, just as in the image to the right. ----->

Simply adjust the clock to your preferred time of day and touch the days of the week to choose which days your Power On or Power Off will occur;

Blue means active, **White** means inactive.

For example, if you set your **Power On Time** to 8:30 AM and highlight the *M, T, W, T, F* tiles, then your display will automatically power on at 8:30 AM, Monday thru Friday, while skipping Saturday and Sunday, every week.

 *Utilizing these settings is highly recommended if you expect heavy use and long hours for your AVE-5530 display, as this will help maintain its longevity.*

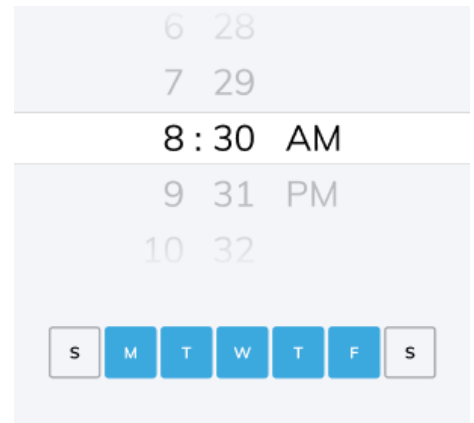

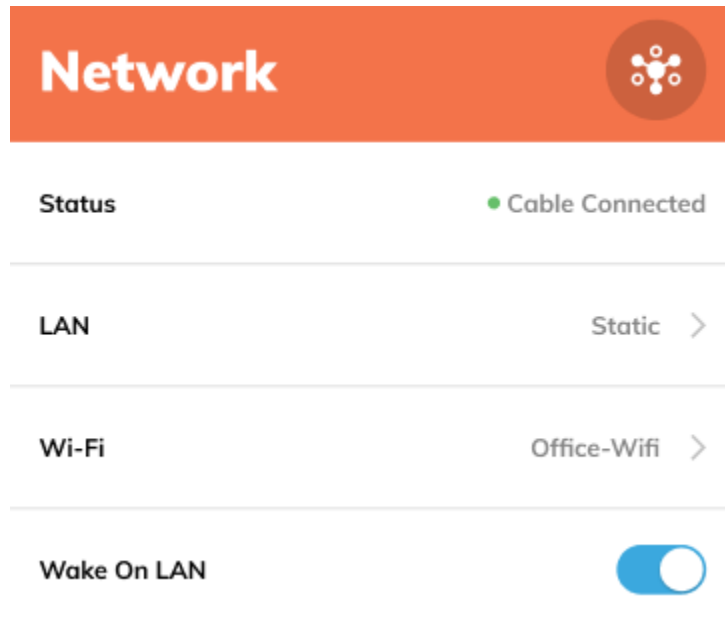

Status	Shows Network and LAN status (Cable Connected , Not Connected).
LAN	Set a Static IP or DHCP .
Wi-Fi	Configure Wi-Fi settings (additional USB device required); locate the MAC Address .
Wake On LAN	Toggle Wake On LAN .

NETWORK SETTINGS TIPS

Here is where you can set your **Network** configurations to enable a wired LAN connection, or a Wi-Fi connection (Wi-Fi USB device required). You also need to configure your **LAN** settings to be able to enable *TCP/IP control*. Here are some tips to help get you started.

LAN

For a wired connection to either the **Ethernet In** or **Ethernet Out** port; here you'll assign an IP address and other necessary network parameters for your display. You can set your parameters manually by choosing the **Static** option or automatically via **DHCP**, if available. *Consult your network administrator to see if DHCP is an option!*

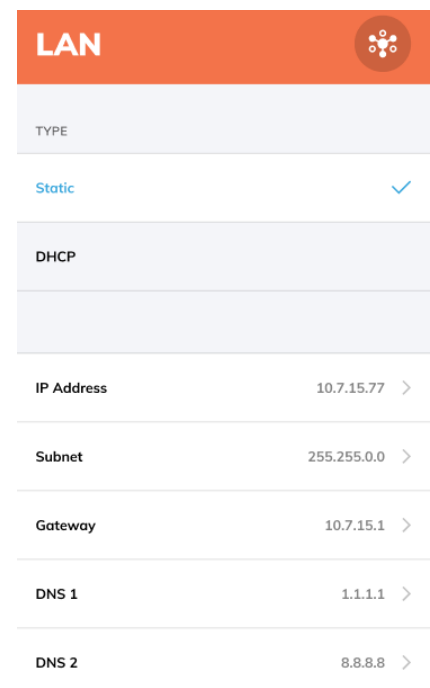

Language



Language

English (US) >

Language	Set the language for the display's user interface.
-----------------	--

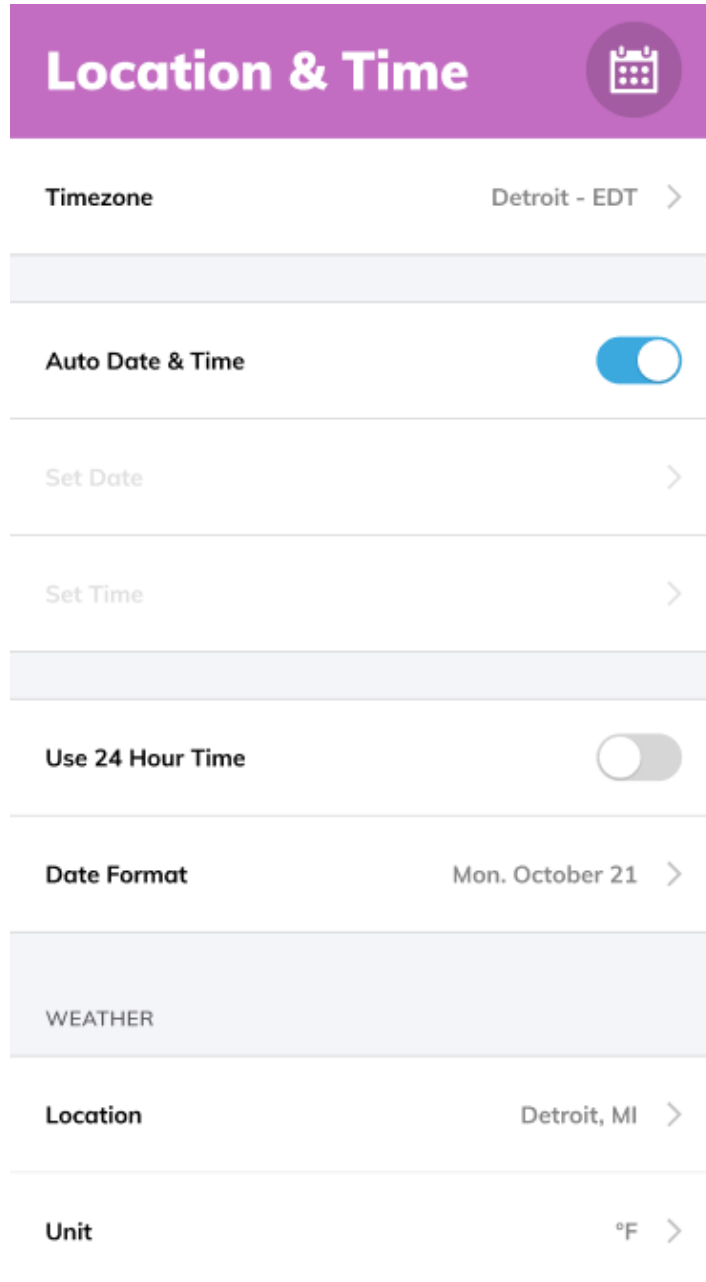

Timezone	Set Timezone based on city and region.
Auto Date & Time	Toggle Auto Date & Time On (internet connection required) or Off .
Set Date	Manually set the date.
Set Time	Manually set the time.
Use 24 Hour Time	Toggle 24 Hour Time On or Off .
Date Format	Set date format.
Location (Weather)	Set the region for accurate weather information.
Unit (Weather)	Set unit for measure of temperature (°F, °C)

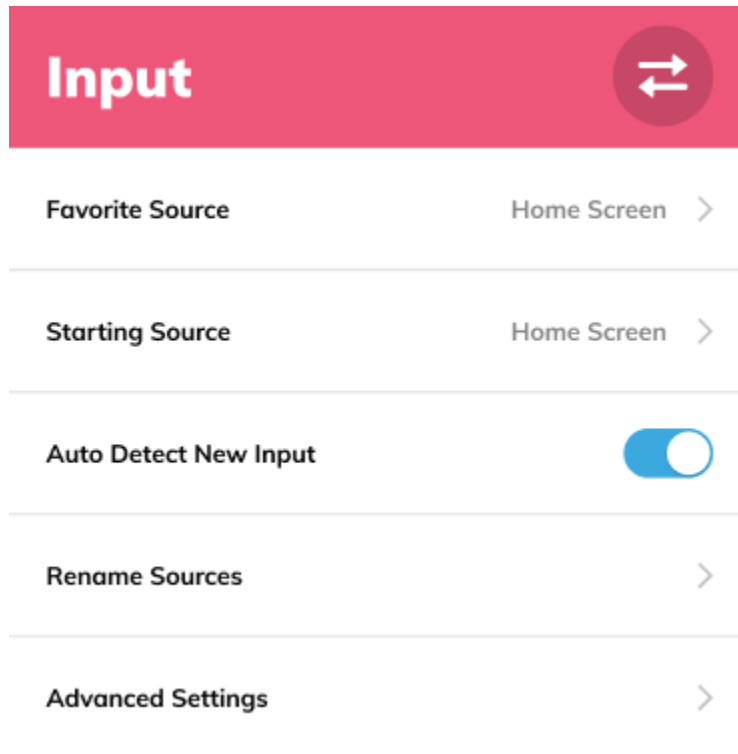

Favorite Source	Set the favorite source (Home Screen, OPS Computer, HDMI Front, HDMI 1, HDMI 2, DisplayPort, Type C).
Starting Source	Set the default source the display will show automatically upon powering on the display (Home Screen, OPS Computer, HDMI Front, HDMI 1, HDMI 2, DisplayPort, Type C).
Auto Detect New Input	Toggle Auto Detect New Input ; determines whether the display will automatically switch to a new connection.
Rename Sources	Set custom names for the display's input sources.
Advanced Settings	Toggle Wake on Input and set EDID .

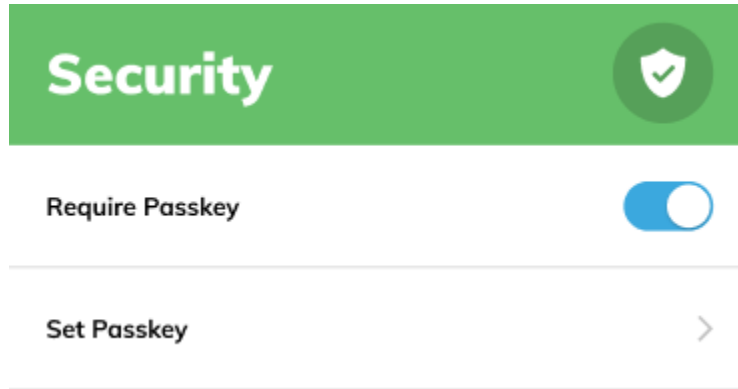

Require Passkey	Toggle Require Passkey on/off.
Set Passkey	Set a custom Passkey to access display settings.
Lock Front Keys	Locks the buttons on the front panel of the display.

About
Q

Name
Avocor E30 Display

System Version
5.0.1

Firmware Version
HHT_U6H0L13T5M0005NYENEN_MS828.15.A75_V1.3.3
_20180621.144018_785b2ec

Serial Number
23894E4KDN4820-4931

Model Number
E6520

Update System ✓ Up To Date >

Factory Data Reset >

Customer Service

Contact Avocor customer service with any questions or concerns at 855-268-7999 or visit avocor.com/enquire to submit a support ticket.

Name	The full name and model of the display.
System Version	The active system version number.
Firmware Version	The active firmware version number.
Serial Number	The unique serial number for the display.
Model Number	The model number of the display.
Update System	Used to update the display's firmware.
Factory Reset	Used to restore the display's factory default settings.

UPDATE SYSTEM – FIRMWARE

You can easily update your system firmware by opening the **About** menu in your display's OSD and clicking **Update System**.

From here, you have two options:

1. Download & Apply Update

- This will allow you to easily update your firmware a stable internet connection. We recommend using a wired connection to ensure the process is successful.

2. USB Update

- This is a more manual process that requires you to download the correct file from Avocor.com, and upload the file via the USB Service Port on the display.

New System Version
5.0.2

New Firmware Version
HHT_U6H0L13T5M0005NYENEN_MS828.15.A75_V1.3.3_20180621.144018_785b2ec

over

Release Notes

- Improved EDID compatibility.
- Fixed Wake on Input when using DisplayPort.
- Improved input switching time.
- UI updates.
- Various bug fixes.

Download & Apply Update →

USB Update >

USB Update - Instructions

For your convenience, detailed instructions will appear once you open the USB Update option in the OSD menu.



1. Download the firmware update by selecting the relevant display from: <https://www.avocor.com/support/> and then selecting firmware.
2. Change the name of the downloaded firmware file name to bin (e.g. change Scaler_AVG-6550_V104.bin to merge.bin)
3. Prepare a USB stick formatted to FAT32.
4. Copy the renamed merge.bin firmware file onto the USB stick.
5. Connect the USB stick to the Service USB Port on the display.

Insert USB →



Once a compatible USB Stick has been detected, the **Insert USB** button will highlight and change:

Apply Update →

You can then press the button, and the update will apply automatically.

EXTERNAL CONTROL

RS232 Connection and Port Configuration

Connect your control system or PC to the RS232 input of the display via a 9-pin NULL modem connector cable, and set the baud rate to 19200 on your controller device.

TCP/IP Control Configuration

Connect your network, control system, or PC to the display's **Ethernet In** or **Ethernet Out** port via a CAT5 cable. The display must be connected to the network and must have a valid IP address. Configure your control system to run through **TCP port 4884**.

Command and Response Format

Any commands sent from an automation/control system or PC to an Avocor display must have the following format:

[STX] [IDT] [TYPE] [CMD] [VALUE]/[REPLY] [ETX] [CR]

- [STX] indicates the start of the command data (always 07).
- [IDT] is the display ID (always 01).
- [TYPE] is the command type:
 - 00 = return to host (response from the LCD panel)
 - 01 = read / action
 - 02 = write
- [VALUE] is the parameter setting for the command.
- [REPLY] is the parameter setting for the command, acknowledged by the display in its response to a command.
- [ETX] indicates the end of the command data (always 08).
- [CR] is the ASCII carriage return key (0x0D).

Serial Command List

Main Item	Control Item	CMD HEX	Type HEX	Value HEX	Reply HEX	Content	CMD (ASCII)
Power Control	Power	POW	W/R	0	0	Off	50 4F 57
				1	1	On	
	IPC Control	IPC	W/R	0	0	Off	49 50 43
				1	1	On	
Input Source	Source Selection	MIN	W/R	0	0	VGA	4D 49 4E
				9	9	HDMI 1	
				0A	0A	HDMI 2	
				0B	0B	HDMI 3 (Front)	
				0D	0D	DisplayPort	
				0E	0E	OPS	
Picture Settings	Backlight	BRI	W/R	00~64	00~64	Backlight	42 52 49
		BLC		0	0	Off (Backlight)	42 4C 43
				1	1	On (Backlight)	
	Digital Settings	BRL	W/R	00~64	00~64	Brightness	42 52 4C
		CON		00~64	00~64	Contrast	43 4F 4E
		HUE		00~64	00~64	Hue	48 55 45
		SAT		00~64	00~64	Saturation	53 41 54
	Noise Reduction	NOR	W/R	0	0	Noise Reduction Off	4E4F 52
				1	1	Noise Reduction: Low	
				2	2	Noise Reduction: Medium	
				3	3	Noise Reduction: High	
	Color Gain/Offset	USR	W/R	00~64	00~64	Red Gain	55 53 52
		USG		00~64	00~64	Green Gain	55 53 47

Picture Settings	Color Gain/Offset	USB	W/R	00~64	00~64	Blue Gain	55 53 42
		UOR		00~64	00~64	Red Offset	
		UOG		00~64	00~64	Green Offset	
		UOB		00~64	00~64	Blue Offset	
	Sharpness	SHA	00~64	00~64	Sharpness	53 48 41	
Other Control	Scaling	ASP	W/R	0	0	Point to Point	41 53 50
				1	1	Full Screen (16:9)	
				2	2	Pillarbox (4:3)	
				3	3	Letterbox	
				4	4	Auto	
	Remote Control	RCU	W	0	0	MENU Key	52 43 55
				1	1	INFO Key	
				2	2	UP Key	
				3	3	DOWN Key	
				4	4	LEFT Key	
				5	5	RIGHT Key	
				6	6	OK Key	
				7	7	EXIT Key	
				0A	0A	HDMI1 Key	
				0B	0B	HDMI2 Key	
				1F	1F	HDMI Front Key	
				22	22	DisplayPort Key	
				23	23	Type C Key	
				21	21	OPS Key	
17	17	SCALING Key					

Other Control	Remote Control	RCU	W	18	18	FREEZE Key	52 43 55
				19	19	MUTE Key	
				1C	1C	AUTO Key	
				1D	1D	VOLUME+ Key	
				1E	1E	VOLUME- Key	
	Factory Reset	ALL	W	0	0	Reset all	41 4C 4C
				1	1	Reset all but communication	
	Display Information	SER	R		13 bytes	Read Serial Number	53 45 52
		MNA	R		13 bytes	Read Model Name	47 56 45
		GVE	R		6 bytes	Read Firmware Ver.	4D 4E 41
	Audio	VOL	W/R	00~64	00~64	Volume	56 4F 4C
		BAS	W/R	00~14	00~14	Bass (-10~10)	42 41 53
		TRE	W/R	00~14	00~14	Treble (-10~10)	54 52 45
		BAL	W/R	00~14	00~14	Balance (-10~10)	42 41 4C
		VOL	W/R	00~64	00~64	Volume Set	56 4F 4C
		VOD	W	0	0	Volume Decrease by 5	56 4F 44
		VOI	W	1	1	Volume Increase by 5	56 4F 49
		MUT	W/R	0	0	Mute Off	4D 55 54
	1			1	Mute On		
	Scheme Selection	SCM	W/R	0	0	User	53 43 4D
				1	1	Vivid	
2				2	Cinema		
3				3	Game		
4				4	Sport		
EcoMode	WFS	W/R	1	1	Set DIGITAL, RS232, Ethernet	57 46 53	

Other Control	EcoMode	WFS	W/R	2	2	Set Never_Sleep	57 46 53
	RTC (2 bytes)	RTY	W/R	00~63	00~63	Set Real time Year	52 54 59
		RTM		01~0C	01~0C	Set Real time Month	52 54 4D
		RTD		01~1F	01~1F	Set Real time Day	52 54 44
		RTH		00~17	00~17	Set Real time Hour	52 54 48
		RTN		00~3B	00~3B	Set Real time Minute	52 54 4E
	Freeze	FRE	W/R	00	00	Unfreeze	46 52 45
				01	01	Freeze	
	Auto Scan	ATS	W/R	0	0	Auto Scan Off	41 54 53
				1	1	Auto Scan On	
	All EDID	EDA	W/R	0	0	4Kx2K 60Hz	45 44 48
				1	1	4Kx2K 30Hz	
				2	2	1080P	
	HDMI EDID	EDH	W/R	0	0	4Kx2K 60Hz	45 44 48
				1	1	4Kx2K 30Hz	
				2	2	1080P	
	DisplayPort EDID	EDP	W/R	0	0	4Kx2K 60Hz	45 44 50
				1	1	4Kx2K 30Hz	
2				2	1080P		
RGB Color Range	HC R	W/R	0	0	Auto Detect	48 43 52	
			1	1	0-255		
			2	2	16-235		
OSD Control	OSD Language	OSL	W/R	0	0	English	4F 53 4C
	OSD Timeout	OSO	W/R	05~3C	05~3C	OSD Timeout (5, 10, 20, 30, 60 sec)	4F 53 4F
Ethernet Setup	Network Enable	NWE	W/R	0	0	No	4E 57 45

Ethernet Setup	Network Enable	NWE	W/R	1	1	Yes	4E 57 45
	MAC ID Query	MAC	W	00~05	00~FF	Querying MAC ID #0~#5	4D 41 43

WARRANTY INFORMATION

COVERAGE

Avocor warrants to the first end user customer that the product, when shipped in its original container, will be free from defective workmanship and materials, and agrees that it will, for a period of **three (3) years** from the date of purchase, repair or replace the defective product or part thereof, at Avocor's discretion, with a new or equivalent at no charge to the customer. Advanced Field Replacement (AFR) service is included as part of this warranty.

Except as specified herein, this warranty covers all defects in material or workmanship in the product. AVOCOR'S LIABILITY FOR ANY DEFECTIVE PRODUCT IS LIMITED TO THE REPAIR OR REPLACEMENT OF THE PRODUCT AT AVOCOR'S DISCRETION. REPLACEMENT PARTS OR PRODUCTS MAY BE NEW OR 'LIKE NEW' UNDER THE CONDITIONS SPECIFIED BELOW. All parts or products removed under this warranty become the property of Avocor.

The replacement part or product is warranted for the remainder of the original limited warranty period or thirty days from shipment, whichever is longer.

LIMITATIONS ON WARRANTY COVERAGE, DURATION, AND SERVICES MAY SOMETIMES VARY BASED ON THE LAWS OF SPECIFIC REGIONS, STATES, AND COUNTRIES. THIS LIMITED WARRANTY GIVES YOU SPECIFIC LEGAL RIGHTS, AND YOU MAY HAVE OTHER RIGHTS WHICH VARY FROM JURISDICITON TO JURISDICTION.

Exclusions

This warranty does not apply to any cosmetic or consumable items of the Product or if the serial number or model number affixed to the Product has been removed, defaced, changed, altered or tampered with.

This warranty does not cover installation, signal reception problems, potential incompatibility with peripheral devices, or acts of nature. Avocor does not warrant nor shall it be liable for Products which have been subject to abuse, including, but not limited to, improper voltage, accident, misuse, negligence, lack of reasonable care, alteration, modification, tampering, improper installation, shipping damage, operation or maintenance or any damages or defects caused by repairs or attempted repairs performed by anyone other than Avocor personnel or an Avocor-authorized servicer.

Please refer to Avocor's pixel policy for warranty guidelines on pixel related issues.

This warranty also excludes any damage to product glass due to pressure, abrasion, scratches, or actions otherwise beyond normal operation of the product that would cause screen mura and image retention (see PRECAUTION on page 27).

Concealed Damage

It is the customer's responsibility to inspect new product(s) at the time of delivery.

If packaging is found damaged *at the time of delivery*, the Customer should refuse delivery and note on the delivery receipt the product and details pertaining to damage. The Customer may accept packages with minor damage but must take note of product details and damage on the delivery receipt.

If patent or obvious physical damage is detected *after delivery is accepted* and a "clean" or unmarked delivery receipt was returned, it is the customer's responsibility to file an insurance claim to the shipping provider according to the requirements set forth in the shipping provider's policy.

If the product packaging is clean and undamaged, but patent or obvious physical damage is found on the product, the customer must report the damages to their product distributor, shipper, or seller, within the policy guidelines of the distributor, shipper, or seller.

If freight was arranged by Avocor, and patent or obvious physical damage to the packaging is not detected but found on the product or product accessories upon inspecting the product, the customer must report the damages to Avocor within 10 calendar days after the delivery date to receive warranty services.

Customer Data

If the customer's product is capable of storing software programs, data, and other information, it is the customer's responsibility to protect its contents against operational failure. It is also the customer's responsibility to keep a separate backup of the contents and remove all personal information and disable security passwords prior to delivering a product for warranty service. ANY PERSONAL CONTENT WILL BE DELETED AND STORAGE MEDIA WILL BE REFORMATTED IN THE COURSE OF WARRANTY SERVICE.

AVOCOR SHALL NOT BE LIABLE, OR IN ANY WAY RESPONSIBLE, FOR ANY INCIDENTAL OR CONSEQUENTIAL ECONOMIC OR PROPERTY DAMAGE. SOME REGIONS DO NOT ALLOW LIMITS ON WARRANTIES OR ON REMEDIES FOR BREACH IN CERTAIN TRANSACTIONS; IN SUCH REGIONS, THE LIMITS HEREIN MAY NOT APPLY. THIS WARRANTY IS IN LIEU OF ALL OTHER WARRANTIES, EXPRESSED OR IMPLIED. AVOCOR DISCLAIMS ALL OTHER WARRANTIES, EXPRESSED OR IMPLIED, INCLUDING, BUT NOT LIMITED TO, IMPLIED WARRANTIES OF NON-INFRINGEMENT, MERCHANTABILITY, AND FITNESS FOR A PARTICULAR PURPOSE.

SERVICES

Technical Support: The Customer must contact Avocor Technical Support, via email at service@avocor.com in order to initiate an RMA or another warranty service. Customer agrees to cooperate with Avocor: (A) to notify Avocor promptly of any defect, error or Hardware Product malfunction and to submit to Avocor such information that Avocor may reasonably require to reproduce the error or Hardware Product malfunction and the operating conditions under which the error or Hardware Product malfunction was discovered; (B) to follow Avocor's guidelines to troubleshoot reported faults on the defective product(s); (C) to install, if

requested by Avocor and within Customer security guidelines, a network connection that will be made available to Avocor for the purpose of resolving problems, reviewing Customer use of software, or for any other reasonable purpose; (D) to have a certified technician repair or replace defective parts under Avocor's guidance; (E) to notify Avocor of any additional hardware or software not purchased from Avocor that may be used in conjunction with the Hardware Product.

Onsite Repair: If Avocor deems the Product repairable, it will, at its discretion, send a technical support representative and/or technician to provide onsite repair or replacement service for any repairable or replaceable parts. Customer may be asked to provide access to, and to assist in the handling of, the Product, as deemed necessary by Avocor, under the instruction of the field representative or technician.

Advance Field Replacement (AFR): Avocor will ship a like-new or refurbished replacement product to the customer, at its discretion, if the product defect is determined to be unreparable. The Customer must provide the display model and serial number and will be asked to provide contact details for the shipment. Upon approval, Avocor will ship the replacement product to the customer's site.

AFR Guidelines: At the time of the new product's arrival to the customer, it is the customer's responsibility to facilitate the deinstallation of the defective product, installation of the replacement product, and packing of the defective product in either its original packaging or the packaging of the replacement, and then send the defective back with the same driver that delivered the replacement product on that same day. If the customer is not able to perform the same-day swap they will incur the cost of freight. Additionally, if the product is not returned within 15 business days, the customer will be invoiced in full for the replacement product.

SHIPMENTS TO CERTAIN INTERNATIONAL LOCATIONS MAY NOT BE SUBJECT TO THE ABOVE AFR GUIDELINES. CONTACT SUPPORT FOR FURTHER DETAILS.

Defective on Arrival (DOA): If the Product is determined by Avocor to be defective within the first 90 days of the initial purchase by the Customer, it is deemed Defective on Arrival (DOA). In the case of a DOA, the Customer will be provided a brand-new equivalent Product. In the case that an RMA is issued after the 90 DOA period, the defective product will be replaced with a refurbished "like new" equivalent product, if available.

Repair with Expired Warranty: Avocor offers repair services, at cost to the Customer based on time and materials, for products with expired warranty. Customer will be responsible for all shipment costs.

For more information, please email at service@avocor.com.