

Operating Instructions Functional Manual

UHD LCD Display For business use

English

Model No. TH-86SQE1W - TH-86CQE1W
TH-75SQE1W - TH-75CQE1W
TH-65SQE1W - TH-65CQE1W
TH-55SQE1W - TH-55CQE1W
TH-49SQE1W - TH-49CQE1W
TH-43SQE1W - TH-43CQE1W

86-inch model

75-inch model

65-inch model

55-inch model

49-inch model

43-inch model



Read before use

For more information about this product, please read the “Operating Instructions – Functional Manual”.

To download the “Operating Instructions – Functional Manual”, please visit the Panasonic website (<https://panasonic.net/cns/prodisplays/>).

English

- Please read these instructions before operating your set and retain them for future reference.
- Illustrations and screens in this Operating Instructions are images for illustration purposes, and may be different from the actual ones.
- Descriptive illustrations in this Operating Instructions are created mainly based on the 75-inch model.

4K
PROFESSIONAL
*Actual resolution:
3840 × 2160p

HDMI™



Dear Panasonic Customer
Welcome to the Panasonic family of customers. We hope that you will have many years of enjoyment from your new LCD Display. To obtain maximum benefit from your set, please read these Instructions before making any adjustments, and retain them for future reference.

Retain your purchase receipt also, and note down the model number and serial number of your set in the space provided on the rear cover of these instructions. Visit our Panasonic Web site.

<https://panasonic.net/cns/prodisplays/>



Contents

Before use

- Illustrations and screens in this Operating instructions are images for illustrations purposes, and may be different from the actual ones.
- Descriptive illustrations in this Operating Instructions are created mainly based on the 98-inch model

Important Safety Instruction.....	2
FCC STATEMENT.....	5
Precautions for use.....	5
Important Safety Notice.....	6
BATTERY SAFETY GUIDELINES.....	7
About Wireless LANs.....	7
Disposal.....	8
Markings on the Product.....	8
Accessories Included.....	9
General View.....	10
Control Buttons on the Display.....	11
Connecting the IR Receiver.....	12
Turning the Display On/Off.....	12
Remote Control.....	13
CAUTION for AC CORD.....	14
Fixing the IR Sensor.....	15
Fixing the Wi-Fi Dongle.....	15
Attaching the Function SLOT.....	16
Cautions When Moving.....	17
Shipping.....	18
Using Main Display Menu.....	18

Media Playback via USB Input.....	19
CEC and CEC RC Passthrough.....	20
Audio Return Channel.....	20
Settings Menu Content.....	21
Connectivity.....	31
Wired Connectivity.....	31
Notes on Using Wired LAN.....	31
Wireless Connectivity.....	32
Wake ON.....	32
Wireless Display.....	33
Connectivity Troubleshooting.....	33
Apps.....	34
Internet Browser.....	34
OSD Rotation Support.....	34
DisplayPort.....	34
USB-C.....	35
Real Time Clock (RTC).....	35
Serial IN Terminal Connection.....	35
Control Command via LAN.....	36
PJLink protocol.....	38
Preset Signals.....	39
Supported Media Formats From USB.....	42
Specifications.....	45
Troubleshooting.....	48
Mounting the display.....	51
Vesa Wall Mount Measurements.....	51
Cautions when attaching wall mount and stand...51	51
Installation On An Indented Wall.....	52
Cautions for portrait setting.....	53
License Notification.....	53
Software License.....	54
Service Centre.....	55

	WARNING RISK OF ELECTRIC SHOCK DO NOT OPEN	
<p>WARNING: To reduce the risk of electric shock, do not remove cover or back. No user-serviceable parts inside. Refer servicing to qualified service personnel.</p>		

Please read these instructions fully and carefully before use and keep for future reference

The lightning flash with arrow-head within a triangle is intended to tell the user that parts inside the product are a risk of electric shock to persons.



The exclamation point within a triangle is intended to tell the user that important operating and servicing instructions are in the papers with the appliance.



SLOT USAGE WARNING: Do not plug the SLOT unit while the Display is turned on. Turn on the SLOT unit using the remote control or the buttons on the Display, do not turn it on using the buttons on the device itself.

WARNING: This device is not intended for use by persons (including children) without physical, sensory or mental capabilities, or lack of experience and/or knowledge unless they have been given supervision or instruction concerning use of the device by a person responsible for their safety.

Important Safety Instruction

• This product is for indoor use only.

Environmental temperature to use this unit

- When using the unit where it is below 1 400 m (4 593 ft) above sea level: 0 °C to 40 °C (32 °F to 104 °F)
- When using the unit at high altitudes (1400 m (4593 ft) and higher and below 2800 m (9186 ft) above sea level): 0 °C to 35 °C (32 °F to 95 °F)

Do not install the unit where it is 2800 m (9186 ft) and higher above sea level.

- Failure to do so may shorten the life of the internal parts and result in malfunctions.
- Please keep this manual for further use.

- Unplug your product before starting to clean. Do not clean the product when it is on. Do not use liquid or aerosol cleaners. Use a damp cloth for cleaning. If that does not help, please use LCD display cleansers. Do not apply the cleaner directly on the product.
- To prevent breakdown, do not use non-advised accessories.
- Please do not place your product near wash basins, sinks, water pans, pools etc.
- To prevent damage which may result in fire or shock hazard, Do not expose the product to dripping or splashing of liquids and do not place objects filled with liquids, such as vases, cups, etc. on or over the product (e.g., on shelves above the unit).
- Please leave at least 5 cm of free space between the product and walls or other furnitures for ventilation purposes.
- That product can only be started by the defined power source on its rating plate. For further information, please contact with your dealer.
- As a safety precaution, a three-wired grounding plug is given with the product. As a safety precaution, please do not make any change on the grounding plug. Always use earthed socket outlet for product.
- Please provide the plug and socket to supply the needed power for appliance.
- Please place the product in a position that electric cables cannot be affected by the operations on the product.
- Follow all warnings and instructions marked on the product.
- Follow the on screen instructions for operating the related features.
- To prevent the risk of fire or electric shock, please do not overuse the plugs and extension cords. Please do not open the lid of the display to service yourself. If the required service needs are not met by an authorized service, dangerous voltage and other risks may occur.
- If you will not use the product for a long period of time, unplug the power cord from the mains.
- Put the product on a well-ventilated place and prevent from bright light, overheat and damp.
- The product should be kept in 0 °C - 40 °C. Otherwise, the appliance may be damaged permanently.
- Plug the appliance to a grounded outlet. Always use the grounded power cord supplied with your product. Manufacturer is not responsible for any damage caused unearthed usage.

- For permanently connected equipment, a readily accessible disconnect device shall be incorporated in the building installation wiring.
- For pluggable equipment, the socket-outlet shall be installed near the equipment and shall be easily accessible.
- Do not stay in contact with the parts of the product that become hot for long periods of time. Doing so may result in low-temperature burns.
- The LCD panel used in this product is made of glass. Therefore, it can break when the product is dropped or applied with impact. Be careful not to be injured by broken glass pieces in case the LCD panel breaks.
- Usage of the display must not be accompanied by fatal risks or dangers that, could lead directly to death, personal injury, severe physical damage or other loss, including nuclear reaction control in nuclear facility, medical life support system, and missile launch control in a weapon system.
- Do not expose the product to direct sunlight or do not place open flames such as lit candles on the top of or near the product.
- Do not place any heat sources such as electric heaters, radiators, etc. near the product.
- In order to prevent a potential electrical shock, in extreme weather (storms, lightning) disconnect the product from the mains.
- Do not touch the controls other than those described in the operating instructions. Improper adjustment of controls not described in the instructions can cause damage, which often requires extensive adjustment work by a qualified technician.
- Do not shake the product. Ensure that it stays in a balanced stance on its position.
- Do not throw or drop any object on your product.
- Do not interfere on your products screen or any other surface with a sharp object.
- Do not keep your product in a humid environment.
- Do not keep your product in an extremely cold environment.
- Do not keep your product in an extremely hot environment.
- Do not place the product on the floor and inclined surfaces.
- Small parts can present choking hazard if accidentally swallowed. Keep small parts away from young children. Discard unneeded small parts and other objects, including packaging materials and plastic bags/sheets to prevent them from being played with by young children, creating the potential risk of suffocation.
- Only use attachments / accessories / specified by the manufacturer.

- The wireless LAN feature of this display shall exclusively be used inside buildings.
- Be sure to disconnect all cables and overturn prevention accessories before moving the Display.
- If the Display is moved while some of the cables are still connected, the cables may become damaged, and fire or electric shock could result. Clean the power supply plug regularly to prevent it becoming dusty. If there is a buildup of dust on the plug, the resultant humidity may cause short-circuit, which could cause electric shock or fire. Unplug the power supply plug from the wall outlet and wipe it with a dry cloth.

Vent holes of the product

The vent holes are designed to provide the product to work constantly and prevent it from overheat. Do not block these openings in anyway. For the same reason, please do not place your product on beds, sofas, carpets and similar surfaces.

Never insert an object into the product through vents or openings. High voltage flows in the product, and inserting any objects in the vents or openings of the product may cause electric shock, short circuit of the internal parts and/or fire. For the same reason, do not spill water or liquid on the product.

Repair

Unless a basic implementation on the product is specified by the producers' technical department on a document, do not repair your product by yourself. Otherwise, your guarantee may get suspended and you may risk your health or your product. In case of need, consult your authorized service.

- When the cable is worn off or harmed.
- If the product has been dropped or the cabinet has been damaged.
- If the performance of the product is changed or the appliance needs to be repaired.
- When a liquid was spilled on the product or when objects have fallen into the product.
- When the product has been exposed to rain or water.
- When the product does not operate properly as described in the operating instructions.

Replacement parts

In case the product needs replacement parts, make sure that the service person uses replacement parts specified by the manufacturer, or those with the same characteristics and performance as the original parts. Use of unauthorized parts can result in fire, electric shock and/or other danger.

Safety checks

Upon completion of service or repair work, request the service technician to perform safety checks to ensure that the product is in proper operating condition.

Power Cord

- The power cord is used to disconnect the product from the mains and therefore it must remain readily operable. If the product is not disconnected electrically from the mains, the device will still draw power for all situations even if the product is in standby mode or switched off.
- Use only the power cord supplied with the display.
- Be sure to use the power cord of each destination. Use of the wrong code become cause electric shock or fire.
- Do not damage the power cord nor place heavy objects on it, stretch it, over bend it or step on it. Also, do not add extension cords. Damage to the cord may result in fire or electric shock.
- When unplugging the appliance, always pull directly on the plug. Do not pull from the cable when unplugging the appliance.
- Do not use the power cord with a power tap. Adding an extension cord may lead to fire as a result of overheating.
- Do not remove or insert the power plug with wet hands. Doing so could result in electric shock.
- Unplug the power cord if it is not used for a long time.
- Do not attempt to repair the power cord if it is broken or malfunctioning. When damaged it must be replaced, this should only be done by qualified personnel.

Especially for child safety

- This equipment is not suitable for use in locations where children are likely to be present.
- Don't allow children to climb on or play with the display.
- Don't place the display above furniture that can easily be used as steps.
- Remember that children can become excited while watching a program, especially on a "larger than life" display. Care should be taken to place or install the display where it cannot be pushed, pulled over, or knocked down.
- Care should be taken to route all cords and cables connected to the display so that they cannot be pulled or grabbed by curious children.

Connections



Be sure to turn off the main power switch and disconnect the plug from the power outlet before connecting/

disconnecting cables. Also, read the manual of the equipment to be connected.

Be careful not to confuse the input terminal with the output terminal when connecting cables. Accidentally reversing cables connected to the input and output terminals may cause malfunctions and other problems.

IMPORTANT INFORMATION: Stability Hazard

Positioning

If a display is positioned in an unstable or inclined location, it can be potentially hazardous due to falling. Many injuries, particularly to children, can be avoided by taking simple pre-cautions such as:

- Only using furniture that can safely support the display.
- Ensuring the display is not overhanging the edge of the supporting furniture.
- Not placing the display on tall furniture (for example, cupboards or bookcases) without anchoring both the furniture and the display to a suitable support.
- Not placing the display on cloth or other materials that may be located between the display and supporting furniture.
- Using fixing devices like wall mount brackets recommended or supplied by the manufacturer.
- Educating children about the dangers of climbing on furniture to reach the display or its controls. If your existing product is being retained and relocated, the same considerations as above should be applied

Transport and Shipping

- Your device must be kept in its original package to protect from damage to its accessories during transport and shipping.
- Keep the product in normal position during transport.
- Do not drop the device during transport and protect it against impacts.
- Damages and faults that occur during transport after the delivery of the appliance to the customer are not included in the warranty cover.
- Product transportation, installation, repair and servicing must be done by qualified technical service personnel.

Intended Use

- This product is intended to be used in public places such as schools, offices, theatres, places of worship.
- Product is only suitable for connecting commercial mains socket outlets. Do not connect product industrial socket outlets.

FCC STATEMENT

This equipment has been tested and found to comply with the limits for a class A digital device, pursuant to Part 15 of the FCC Rules. These limits are designed to provide reasonable protection against harmful interference when the equipment is operated in a commercial environment.

This equipment generates, uses and can radiate radio frequency energy and, if not installed and used in accordance with the instructions manual, may cause harmful interference to radio communications. Operation of this equipment in a residential area is likely to cause harmful interference in which case the user will be required to correct the interference at his own expense.

FCC CAUTION:

To assure continued compliance, follow the attached installation instructions and use only the provided power supply cord. Any changes or modifications not expressly approved by Panasonic Corp. of North America could void the user's authority to operate this device.

FCC RF Exposure

Warning:

- This Display is provided with built-in transmitter:

Wireless LAN Adapter with

FCC ID:2AVQS-17WFM21/ IC ID: 25888-17WFM21

- This transmitter complies with FCC and IC radiation exposure limits set forth for an uncontrolled environment for mobile use with minimum 8 inches (20 cm) spacing requirement between transmitter and all person's body (excluding extremities of hands, wrist and feet) during wireless modes of operation.

- Other third-party wireless transmitters should not be used as they have not been RF exposure evaluated for use with this Display and may not comply with RF exposure requirements.

<Only for wireless LAN if capable of transmission in the 5.15 ~ 5.25 GHz frequency band>

This product is restricted to indoor use due to its operation in the 5.15 to 5.25 GHz frequency range.

IC requires this product to be used indoors for the frequency range 5.15 to 5.25 GHz to reduce the potential for harmful interference to co-channel Mobile Satellite systems. High power radars are allocated as primary users of the 5.25 to 5.35 GHz and 5.65 to 5.85 GHz bands. These radar stations can cause interference with and/or damage this product.

Supplier's Declaration of Conformity

Model No.

TH-86SQE1W,TH-75SQE1W,TH-65SQE1W,
TH-55SQE1W,TH-49SQE1W,TH-43SQE1W,
TH-86CQE1W,TH-75CQE1W,TH-65CQE1W,
TH-55CQE1W,TH-49CQE1W,TH-43CQE1W

Responsible Party:

Panasonic Corporation of North America
Two Riverfront Plaza, Newark, New Jersey
07102-5490

Contact Source:

Panasonic System Solutions Company of North America

1-877-655-2357

General Contact:

<http://shop.panasonic.com/support>

This device complies with Part 15 of the FCC Rules and all applicable IC RSS standards. Operation is subject to the following two conditions: (1) This device may not cause harmful interference, and (2) this device must accept any interference received, including interference that may cause undesired operation.

CANADIAN NOTICE:

This Class A digital apparatus complies with Canadian ICES-003.

WARNING:

- Not for use in a computer room as defined in the Standard for the Protection of Electronic Computer/ Data Processing Equipment, ANSI/NFPA 75.
- For permanently connected equipment, a readily accessible disconnect device shall be incorporated in the building installation wiring.
- For pluggable equipment, the socket-outlet shall be installed near the equipment and shall be easily Accessible.

Precautions for use

Foreseeable misuse and incorrect use

- For apparatus intended to be used in vehicles, ships or aircraft or at altitudes exceeding 2000m above sea level, for outdoor use or in general for the application other than mentioned in user manual additional requirements may be necessary.

Important Safety Notice



CAUTION



Image retention may occur. If you display a still picture for an extended period, the image might remain on the screen. However, it will disappear when a general moving picture is displayed for a while.

Depending on the temperature or humidity conditions, uneven brightness may be observed. This is not a malfunction.

- This unevenness will disappear while applying current continuously. If not, consult the distributor.

Red, blue or green dots on the screen are a liquid crystal panel-specific phenomenon. This is not a malfunction.

- Although the liquid crystal display is manufactured with high-precision technology, always-lighting dots or non-lighting dots may appear on the screen. This is not a malfunction.

Inch model Dot omission ratio*

86,75,65,55,49,43 0.00004% or less

* Calculated in sub-pixel units according to the ISO09241-307 standard.

WARNING:

This equipment is compliant with Class A of CISPR32. In a residential environment this equipment may cause radio interference.

IMPORTANT: THE MOULDED PLUG FOR YOUR SAFETY, PLEASE READ THE

FOLLOWING TEXT CAREFULLY.

This display is supplied with a moulded three pin mains plug for your safety and convenience. A 5 amp fuse is fitted in this plug. Shall the fuse need to be replaced, please ensure that the replacement fuse has a rating of 5 amps and that it is approved by ASTA or BSI to BS1362.

Check for the ASTA mark or the BSI mark on the body of the fuse.

If the plug contains a removable fuse cover, you must ensure that it is refitted when the fuse is replaced.

If you lose the fuse cover the plug must not be used until a replacement cover is obtained.

A replacement fuse cover can be purchased from your local Panasonic dealer.

Do not cut off the mains plug.

Do not use any other type of mains lead except the one supplied with this display.

The supplied mains lead and moulded plug are designed to be used with this display to avoid interference and for your safety.

If the socket outlet in your home is not suitable, get it changed by a qualified electrician.

If the plug or mains lead becomes damaged, purchase a replacement from an authorized dealer.

WARNING : — THIS DISPLAY MUST BE EARTHED

How to replace the fuse.

Open the fuse compartment with a screwdriver and replace the fuse.

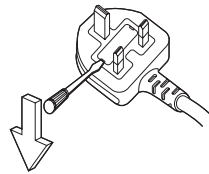

⚠ CAUTION

This appliance is intended for use in environments which are relatively free of electromagnetic fields.

Using this appliance near sources of strong electromagnetic fields or where electrical noise may overlap with the input signals could cause the picture and sound to wobble or cause interference such as noise to appear.

To avoid the possibility of harm to this appliance, keep it away from sources of strong electromagnetic fields.

BATTERY SAFETY GUIDELINES

Used correctly, domestic batteries are a safe and dependable source of portable power. Problems can occur if they are misused or abused resulting in leakage or, in extreme cases, fire or explosion.

Here are some simple guidelines to safe battery use designed to eliminate any such problems.

- Take care to fit your batteries correctly, observing the plus and minus marks on the battery and appliance. Incorrect fitting can cause leakage or, in extreme cases, fire or even an explosion.
- Replace the whole set of batteries at one time, taking care not to mix old and new batteries or batteries of different types, since this can result in leakage or, in extreme cases, fire or even an explosion.
- Store unused batteries in their packaging and away from metal objects which may cause a short-circuit resulting in leakage or, in extreme cases, fire or even an explosion.
- Remove dead batteries from equipment and all batteries from equipment you know you are not going to use for a long time. Otherwise the batteries may leak and cause damage.
- Batteries must not be exposed to excessive heat such as sunshine, fire or the like.
- Never dispose of batteries in fire or with hazardous or flammable materials as this can cause them to explode. Please recycle dead batteries; do not put with the normal household waste.
- Never attempt to recharge ordinary batteries, either in a charger or by applying heat to them. They may leak, cause fire or even explode. There are special rechargeable batteries which are clearly marked as such.
- Supervise children if they are replacing batteries themselves in order to ensure these guidelines are followed.
- Do not ingest the battery, Chemical Burn Hazard.
- This product or the accessories supplied with the product may contain a coin/button cell battery. If the coin/button cell battery is swallowed, it can cause severe internal burns in just 2 hours and can lead to death.
- Remember that small button cell batteries such as used in some hearing aids, toys, games and other appliances, are easily swallowed by young children and this can be dangerous.
- Keep new and used batteries away from children.
- Make sure battery compartments are secure. If the battery compartment does not close securely, stop using the product and keep it away from children.

- Seek immediate medical attention if you believe batteries might have been swallowed or placed inside any part of the body.
- If leaked battery fluid gets on your skin or clothing, rinse immediately and thoroughly. If it gets into your eye, bathe your eye well rather than rubbing and seek medical treatment immediately. Leaked battery fluid that gets into your eye or your clothing may cause a skin irritation or damage your eye.

CAUTION

RISK OF EXPLOSION IF BATTERY IS REPLACED BY AN INCORRECT TYPE.
DISPOSE OF USED BATTERIES ACCORDING TO THE INSTRUCTIONS.

When using this unit, take safety measures against the following incidents.

- Personal information being leaked via this unit
- Unauthorized operation of this unit by a malicious third party
- Interfering or stopping of this unit by a malicious third party

Take sufficient security measures.

- Set a password for the LAN control and restrict the users who can log in.
- Make your password difficult to guess as much as possible.
- Change your password periodically.
- Panasonic Corporation or its affiliate companies will never ask for your password directly. Do not divulge your password in case you receive such inquiries.
- The connecting network must be secured by a firewall, etc.
- When disposing the product, initialize the data before disposing.

About Wireless LANs

- The advantage of a wireless LAN is that information can be exchanged between a PC or other such equipment and an access point using radio waves as long as you are within range for radio transmissions.

On the other hand, because the radio waves can travel through obstacles (such as walls) and are available everywhere within a given range, problems of the type listed below may occur if security-related settings are not made.

- A malicious third-party may intentionally intercept and display transmitted data including the content of e-mail and personal information such as your ID, password, and/or credit card numbers.
- A malicious third-party may access your personal or corporate network without authorization and engage in the following types of behavior.

Retrieve personal and/or secret information (information leak)

Spread false information by impersonating a particular person (spoofing)

Overwrite intercepted communications and issue false data (tampering)

Spread harmful software such as a computer virus and crash your data and/or system (system crash)

- Since most wireless LAN adapters or access points are equipped with security features to take care of these problems, you can reduce the possibility of these problems occurring when using this product by making the appropriate security settings for the wireless LAN device.

- Some wireless LAN devices may not be set for security immediately after purchase. To decrease the possibility of occurrence of security problems, before using any wireless LAN devices, be absolutely sure to make all security-related settings according to the instructions given in the operation manuals supplied with them.

Depending on the specifications of the wireless LAN, a malicious third-party may be able to break security settings by special means.

Please contact Panasonic if you need help taking care of security settings or other such.

If you cannot perform security settings you're your wireless LAN by yourself, please contact the Panasonic Support Centre.

- Panasonic asks customers to thoroughly understand the risk of using this product without making security settings, and recommends that the customer make security settings at their own discretion and responsibility.

Disposal

When disposing the product, ask your local authority or dealer about the correct methods of disposal.

For USA-California Only

This product contains a CR Coin Cell Lithium Battery which contains Perchlorate Material - special handling may apply.

See www.dtsc.ca.gov/hazardouswaste/perchlorate

Markings on the Product

The following symbols are used **on the product** as a marker for restrictions and precautions and safety instructions. Each explanation shall be considered where the product bears related marking only. Note such information for security reasons.



Protective Earth Connection: The marked terminal is intended for connection of the protective earthing conductor associated with the supply wiring.



Hazardous Live Terminal: The marked terminal(s) is/are hazardous live under normal operating conditions.

Any issues which are caused by customer mis-adjustment of any software including the operating system are not covered by the warranty.

Depending on the model you buy, the actual appearance of the product may differ from the images used in this manual.

To maintain compliance with EMC regulations, use shielded cables to connect to the following terminals: HDMI input terminal, D-sub input terminal and RS-232C input terminal.

Trademark Credits

- Microsoft, Windows, Internet Explorer and Microsoft Edge are the registered trademarks or trademarks of Microsoft Corporation in the United States and/or other countries.
- Mac, macOS and Safari are the trademarks of Apple Inc. registered in the United States and other countries.
- PJLink is a registered or pending trademark in Japan, the United States, and other countries and regions.
- HDMI, High-Definition Multimedia Interface and the HDMI Logo are trademarks or registered trademarks of HDMI Licensing Administrator, Inc. in the United States and other countries.

- JavaScript is a registered trademark or a trademark of Oracle Corporation and its subsidiary and associated companies in the United States and/or other countries.
- Crestron Connected, Crestron Connected logo, Crestron Fusion, Crestron RoomView and RoomView are trademarks or registered trademarks of Crestron Electronics, Inc. in the United States and/or other countries.
- USB Type-C® and USB-C® are registered trademarks of USB Implementers Forum.

Even if no special notation has been made of company or product trademarks, these trademarks have been fully respected

Mass

Approx. 111 g. (4 oz) including batteries

Dimensions (W x H x D)

51mm x 27mm x 161mm /
2"x1.1"x6.4"

Attention

- Store small parts in an appropriate manner, and keep them away from young children.
- The part numbers of accessories are subject to change without notice. (The actual part number may differ from the ones shown above.)
- In case you lost accessories, please purchase them from your dealer. (Available from the customer service)
- Dispose the packaging materials appropriately after taking out the items.

Accessories Included

- Remote Control x 1: DPVF3279ZA/X1
- IR Sensor x 1 : DPVF3416ZA/X1
- IR Sensor Holder : DPVF3416ZA/X1
- Screw (for IR Sensor's Holder) x 2 : DPVF3417ZA/X1
- Power Supply Code :
DPVF3408ZA/X1 (USA)
DPVF3409ZA/X1 (UK)
DPVF3410ZA/X1 (Euro)
DPVF3411ZA/X1 (Aus/NZ)
- Batteries x 2: AA/R6/LR6 type
- Cable Clamper x 3 : DPVF3412ZA/X1
- Wi-Fi dongle x 1 : DPVF3413ZA/X1
for 86inch
- Extended Cable (for Wi-Fi dongle) x 1:
DPVF3414ZA/X1
for 86inch
- Spacer x 4: DPVF3499ZA/X1
for 43,49,55SQE1W
- Screw for spacer x 4 : DPVF3500ZA/X1
for 43,49,55SQE1W
- Plate (for IR Sensor's holder)
x 1:DPVF3524ZA/X1
for 86inch

Remote Control Transmitter

Power Source

DC 3V (AA Size batteries x 2)

Operating Range

Approx. 7 m (22.9 ft)
(When operated directly in front
of remote control sensor)

General View

Front Side

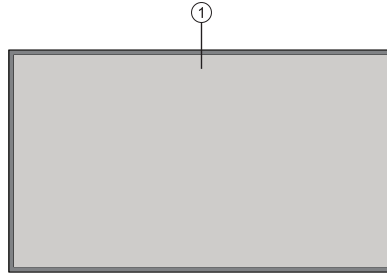

1. LCD Panel

Rear Side (1)

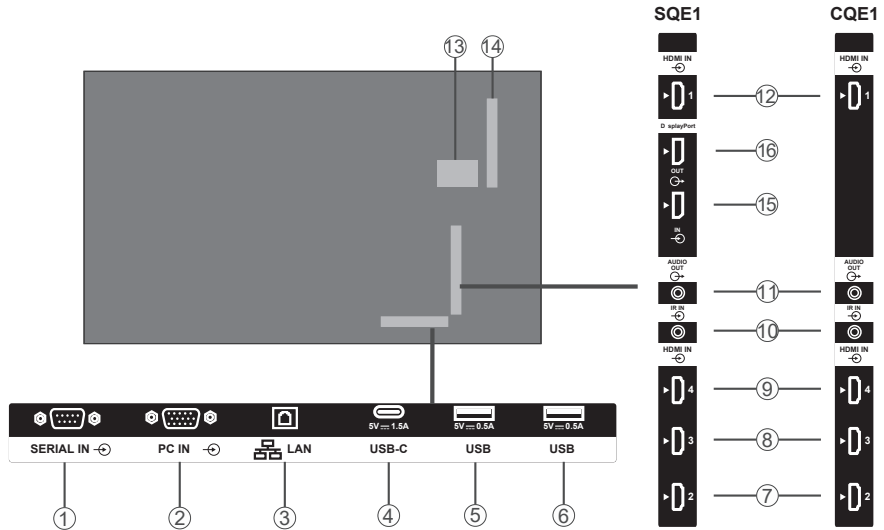

1. SERIAL IN

2. PC IN

3. LAN

4. USB-C

5. USB

6. USB

7. HDMI2 IN

8. HDMI3 IN

9. HDMI4 IN

10. IR IN

11. AUDIO OUT

12. HDMI1 IN

13. Internal USB Compartment

14. Connector for SLOT (Only for SQE1W)

Note:

For the compatible function board, consult the dealer where you purchased the product.

15. DisplayPort IN (Only for SQE1W)

16. DisplayPort OUT (Only for SQE1W)

Rear Side (2)

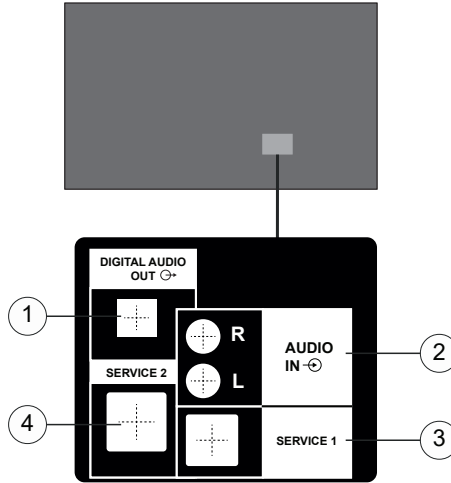

1. DIGITAL AUDIO OUT
2. AUDIO IN
3. RJ12 (SERVICE 1)
4. RJ12 (SERVICE 2)

Note : Don't use except service personnel for RJ12.

Control Buttons on the Display



(rear view)

To turn on the Display: Press the centre of the joystick in and hold it down for a few seconds, the Display will turn on.

To turn the Display off: Press the centre of the joystick in and hold it down for a few seconds, the Display will turn into standby mode.

To change source: Press the centre of the joystick in, the sources list will appear on the screen. Scroll through the available sources by pushing the joystick up or down. After selecting the source, push the joystick "+"

To change volume: Increase the volume by pushing the joystick "+". Decrease the volume by pushing the joystick "-".

Note: Main menu OSD cannot be displayed via joystick.

Connecting the IR Receiver

Before plugging the Display into the mains supply, connect the supplied IR receiver to the IR input on the Display. Place the IR receiver in sight of your own remote control. Simply operate your remote control whilst pointed at the IR receiver and it will relay the control signal to your Display.

Note : Do not expose the display to direct sunlight or strong light source during use.

Otherwise the remote control not work or malfunction may occur since the IR reciever of the display uses infrared rays.

Turning the Display On/Off

After connecting the Display to the mains set the main On/Off switch to the "1" position. The Display will switch into standby mode. Press the **Standby** button on the remote or press the centre of the joystick in located on the rear left side of the Display and hold it down for a few seconds to switch it on from standby.

Press the centre of the joystick in and hold it down for a few seconds or press the Standby button on the remote to switch the Display into standby mode. To switch the Display off, set the On/Off switch to the "2" position.

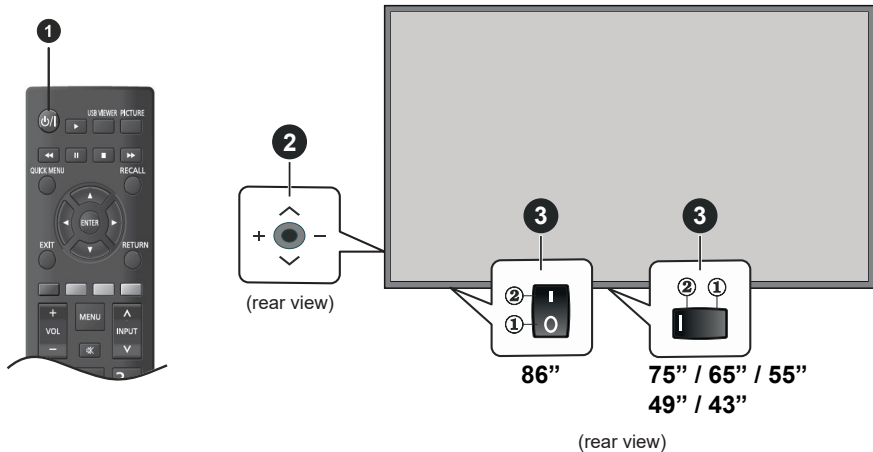

1 Standby button

2 Joystick

3 On/Off Switch (*)

(*) The location of the On/Off switch may differ depending on the model.

LED Status	Status of the display
Power LED lit Green	Power on
Power LED lit Red	Power off (Standby mode)
Power LED Red&Green (slow)	Starting Up
Power LED Red&Green (fast)	Software update

Remote Control

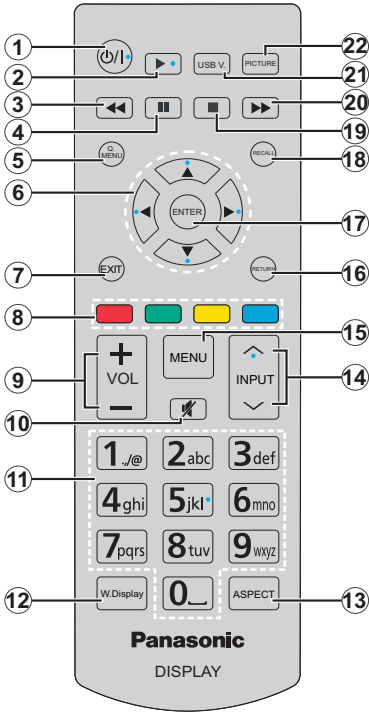

1. **Standby:** Switches On / Off the Display
2. **Play:** Starts to play selected media
3. **Rapid reverse:** Moves frames backwards in media such as movies
4. **Pause:** Pauses the media being played
5. **QUICK MENU:** Displays picture, sound and system setting menus
6. **Directional buttons:** Used to operate the menu screens, content etc.
7. **EXIT:** Closes and exits from displayed menus or returns to previous screen
8. **Coloured Buttons:** Follow the on-screen instructions for coloured button functions
Green: Used in the Scheduler Settings menu.
Blue: Stops the video. Press it again to release it. Audio is output even when the video is stopped.
9. **VOL +/-:** Increases or decreases the volume
10. **Mute:** Completely turns off the volume of the Display
11. **Numeric buttons:** Enters a number or a letter in the text box on the screen.
12. **WIRELESS DISPLAY:** Opens the wireless display connection screen
13. **ASPECT :** Changes the aspect ratio of the screen

14. **INPUT :** Switches input to display on the screen
15. **MENU:** Displays the main menu
16. **RETURN:** Returns to previous screen
17. **ENTER:** Confirms user selections
18. **RECALL:** Displays information about on-screen content
19. **Stop:** Stops the media being played
20. **Rapid advance:** Moves frames forward in media such as movies
21. **USB VIEWER:** Opens the media browsing screen
22. **PICTURE:** Cycles between picture modes

Inserting the Batteries into the Remote Control

Remove the back cover to reveal the battery compartment. Insert two size **AA** batteries. Make sure the (+) and (-) signs match (observe correct polarity). Do not mix old and new batteries. Replace only with same or equivalent type. Place the cover back on.

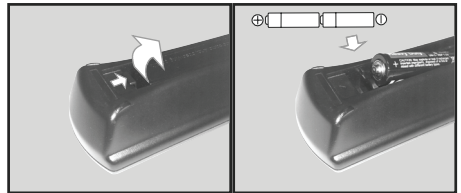

CAUTION for AC CORD

86-inch model

Back of the unit

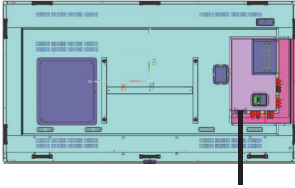

AC Cord Fixing

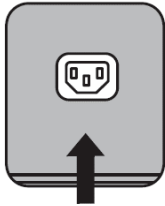

AC Cord (Supplied)

86-inch Model

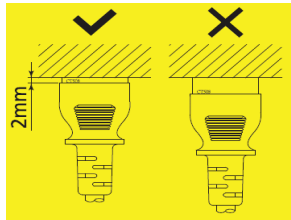

75-inch Model

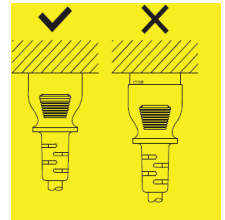

65/55/49/43-inch Model

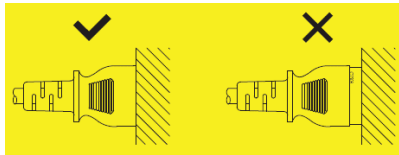

Note

- When disconnecting the AC cord, be absolutely sure to disconnect the AC cord plug at the socket outlet first.
- The supplied AC Cord is for this unit exclusive use. Do not use this for other purposes.

Fixing the IR Sensor

43/49/55/65/75 inch

Attachment of sensor and holder

1. Fix the sensor to holder.
2. Tighten two screws
3. Connect sensor cable to IR IN

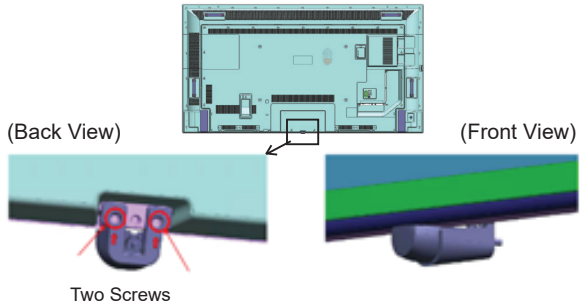
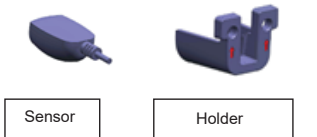

86 inch

Attachment of sensor and holder

1. Remove the five screws.
2. Tighten four screws to plate.
3. Fix the sensor to holder.
4. Tighten two screws to holder
5. Connect sensor cable to IR IN

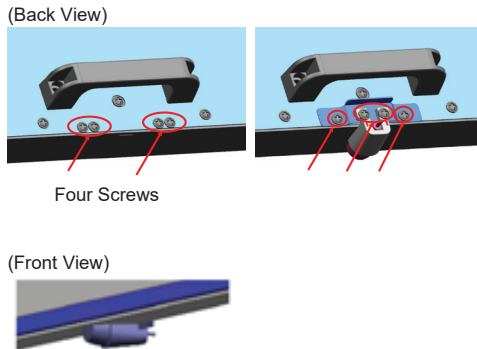
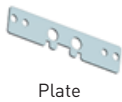

Fixing the Wi-Fi Dongle

86-inch model

1. Peel off the release paper of velcro tape.
2. Fix the Wi-Fi Dongle on the rear cover.
3. Connect the extended cable to Wi-Fi dongle and either USB terminal.

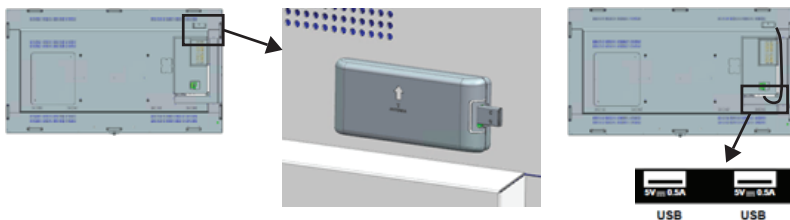

Connect to either USB terminal

Attaching the Function SLOT

(For SQE1W)

1. Remove the two screws and the main unit slot cover.
2. Insert the function board to the main unit slot.
3. Tighten the two screws.

Narrow-width function board

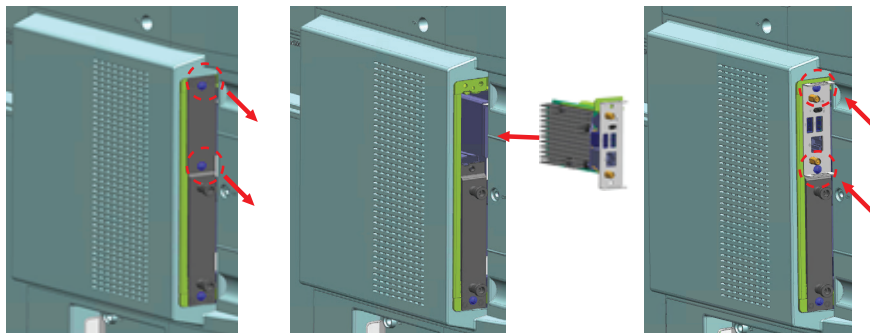

Wide-width function board

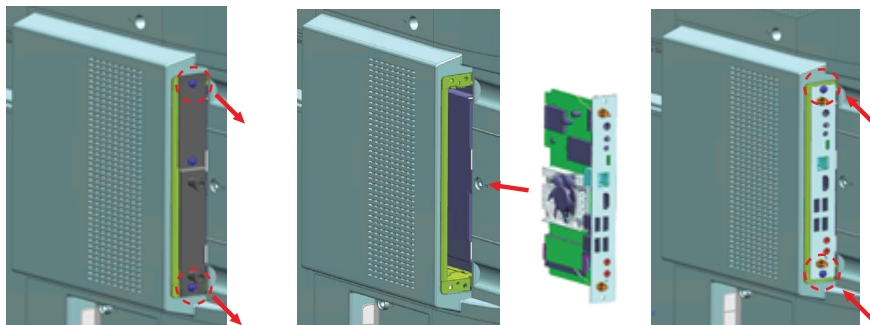

Cautions When Moving

The display has handles for carrying. Hold them when moving.

86-inch model

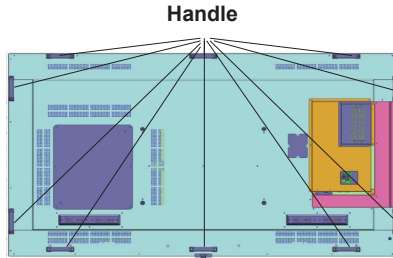

75-inch model

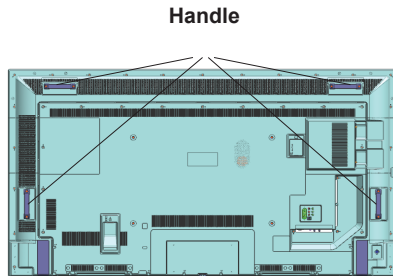

Note

- Do not hold parts other than the handles.
(86-inch model, 75-inch model)
- The following number of people are required to carry this unit.
86-inch model 75-inch model, 4 or more
75-inch model, 65-inch model, 55-inch model, 49-inch model, 43-inch model: 2 or more
If this is not observed, the unit may drop, resulting in injury.
- When carrying the unit, keep the liquid crystal panel upright.
Carrying the unit with the surface of the liquid crystal panel facing up or down may cause deformation of the panel, or internal damage.
- Do not hold the upper, lower, right and left frames or the corners of the unit.
Do not hold the front surface of the liquid crystal panel.
Also, do not hit such parts. Doing so may damage the liquid crystal panel.
Also, the panel may crack, resulting in injury.

Shipping

When turned on for the first time, the language selection screen will be displayed. Select the desired language and press **ENTER**.

On the next screen, set your country preference and press **ENTER** to continue.

You will be asked to set and confirm a PIN at this point. For some country options, the PIN cannot be set to **0000**, in this case you need to enter another 4-digit number combination. You have to enter this PIN if you are asked to enter a PIN for any menu operation later.

The **Signage Settings** menu will be displayed next. **Set ID, OSD Orientation, Auto Software Update** options can be configured using this menu. **Model name, Serial number and Software version** options are for information only. They will be grayed out and not selectable. You can save the model information data of the Display to a connected USB device using the **Save model information** option. You can also copy database files from a connected USB device to the Display using the **Clone from USB** option. Refer to the **Signage Settings Menu Content** section for more information on the options of this menu. After the settings are completed, highlight **Next** and press **ENTER** to continue.

The **Auto Launch Selection** screen will be displayed next. **Open Browser** and **Disabled** options will be available. Highlight the desired option and press **ENTER** to proceed.

On the next screen, the **Network/Internet Settings** menu will be displayed. Please refer to **Connectivity** section to configure a wired or a wireless connection. If you want your Display to consume less power in standby mode, you can disable the **Wake On** option by setting it as **Off**. After the settings are completed highlight **Next** and press **ENTER** button to continue.

The **Shipping** is completed.

To repeat this process and reset the Display's settings to the factory defaults enter the **Settings>Signage** menu, highlight **Shipping** and press **ENTER**. You will be asked to enter the PIN that you have defined in the First Time Installation. If the correct PIN is entered a confirmation message will be displayed asking whether you want to delete all settings and reset the Display. Select **Yes** and press **ENTER** to confirm.

Note: Do not turn off the Display while initializing first time installation. Note that, some options may not be available depending on the country selection.

Note: If you forget the PIN, please contact the service company.

Note: The initial value of PIN is "0000".

Using Main Display Menu

When the **Menu** button is pressed, the main Display menu will appear at the left of the screen. You can navigate through the menu items using the directional buttons on the remote. To select an item or see the sub-menu options of the highlighted menu press **ENTER** button. When you highlight a menu option some of the sub-menu items of this menu may appear on the upper side of the menu bar for quick access. To use a quick access item highlight it, press **ENTER** and set as desired using the Left/Right directional buttons. When finished press **ENTER** or **EXIT/RETURN** button to exit.

Press **EXIT** button to close the main menu.

1. Home

When main menu is opened **Home** menu bar will be highlighted. The content of the **Home** menu can be customised by adding options from other menus. Just highlight an option and press the Down direction button on the remote. If you see **Add to Home** option you can add it to the **Home** menu. Same way you can delete or change the position of any item in the **Home** menu. Press the Down direction button and select **Delete** or **Move** option and press **ENTER**. In order to move a menu item use the Right and Left direction buttons to select the position that you want the item to move to and press **ENTER**.

2. Settings

You can manage the settings of your Display using the options of this menu. Refer to **Settings Menu Contents** section for more information.

3. Apps

When your Display is connected to the Internet related contents will also be available, including **Apps** related contents. Using the **Apps** menu you can access your applications. Refer to **Apps** section for more information.

4. Sources

You can manage your input source references using the options of this menu. To change the current source highlight one of the options and press **ENTER**.

4.1. Source Settings

Enable or disable selected source options. There are also **Regular, Enhanced and Disabled** options available for HDMI source. **Regular** and **Enhanced** options are affecting the colour settings of the HDMI source. To be able to watch 4K or HDR/HLG images from the HDMI source its source setting should be set as **Enhanced** if the connected device is compatible with HDMI 2.0 and subsequent versions. Set as **Regular** if the connected device is HDMI 1.4

compatible. Set accordingly or disable the HDMI source by setting as **Disabled**.

You can reset your customizations on the **Home** and **Apps** menus to defaults using the **Reset Menu** option in the **Settings** menu. Highlight this option and press **ENTER**. A confirmation message will be displayed. Highlight **Yes** and press **ENTER** to proceed.

Media Playback via USB Input

You can connect 2.5" and 3.5" inch (HDD with external power supply) external hard disk drives or USB memory stick to your Display by using the USB input/s of the Display.

IMPORTANT! Back up the files on your storage devices before connecting them to the Display. Manufacturer will not be responsible for any file damage or data loss. Certain types of USB devices (e.g. MP3 Players) or USB hard disk drives/memory sticks may not be compatible with this Display. The Display supports FAT32 and NTFS disk formatting.

Wait a little while before each plugging and unplugging as the player may still be reading files. Failure to do so may cause physical damage to the USB player and the USB device itself. Do not pull out your drive while playing a file.

You can use USB hubs with your Display's USB input/s. External power supplied USB hubs are recommended in such a case.

It is recommended to use the Display's USB input/s directly, if you are going to connect a USB hard disk.

Note: When viewing image files the **Media Browser** menu can only display 1000 image files stored on the connected USB device.





Media Browser Menu

You can play back music and movie files and display photo files stored on a USB storage device by connecting it to your Display. Connect a USB storage device to one of the USB inputs located on the rear side of the Display.

After connecting a USB storage device to your Display **Media Browser** menu will be displayed on the screen. You can access the content of the connected USB device any time later from the **Sources** menu. Select the related USB input option from this menu and press **ENTER**. Then select the file of your choice and press **ENTER** to display or play it back.

You can set your **Media Browser** preferences by using the **Settings** menu. **Settings** menu can be accessed via the information bar which is displayed on the bottom of the screen when pressed the **RECALL**

button while playing back a video file or displaying a picture file. Press the **RECALL** button, highlight the gear wheel symbol positioned on the right side of the information bar and press **ENTER**. **Picture Settings, Sound Settings, Media Browser Settings** and **Options** menus will be available. The contents of these menus may change according to the type of the currently open media file. Only **Sound Settings** menu will be available while playing back audio files.

Loop/Shuffle Mode Operation	
Start playback and activate 	All files in the list will be continuously played in original order
Start playback and activate 	The same file will be played continuously (repeat)
Start playback and activate 	All files in the list will be played once in random order
Start playback and activate 	All files in the list will be continuously played in the same random order.

To use the functions on the information bar highlight the symbol of the function and press **ENTER**. To change the status of a function highlight the symbol of the function and press **ENTER** as much as needed. If the symbol is marked with a red cross, that means it is deactivated.

USB Auto Play Feature

USB AutoPlay feature is to start playing the media content installed on a removable device, automatically. Photo and Video contents in the root directory of the removable device will be played in a sequence (in file name order).

This feature will only work if all of the following circumstances occur:

- The USB device is plugged in.
- **USB Auto Play** option is enabled. It is placed in the **Settings>System>More** menu.

USB Auto Play Feature with Playlist Scenario

If there is a file named as "playlist.txt" installed on the connected USB storage device, the new scenario is started. The media content in this file will be played or displayed according to the entered sequence.

To activate this function, a file named "playlist.txt" should be installed on the USB storage device. Also, the first line of the file must start with "//**do usb auto play**//".

Files which to be displayed/played must be written line by line in playlist.txt. The **"/* */"** expression provides to comment out the line. During playing content, only the volume and standby buttons are used. **EXIT/RETURN** buttons perform the exit operation.

Sample file content:

```
/**do usb auto play**//
```

```
picture.jpg
```

```
video.mp4
```

```
picture2.jpg
```

```
/*picture3.jpg*/
```

```
video2.mp4
```

Scheduler playlist scenario

In this scenario, if the **Source** option is set as **USB** while creating a scheduler, playlist options will be displayed. The user can create 3 different playlists.

When the scheduler is activated, the playlist scenario is started.

During the autoplay, the selected playlist will be checked first. If the selected playlist is not available in connected the USB storage device, the default playlist file will be checked. If the default playlist file is not found, it works just like the USB Auto play scenario.

Note: If some key input is received during auto play, auto play may finish.

Image Search Feature

If **No Signal** option in the **Settings>Signage>Controls** menu is set as **Image Search** the Display checks the connected USB device for available files to play. If no playable files are available or there is no USB device connected to the Display, the No Signal image will be displayed and the Display will turn itself off after a period of 5 minutes. If there isn't any No Signal Image available, No Signal OSD will be displayed on the screen and the Display will turn itself off after a period of 5 minutes.

*Note: The setting of the **USB Auto Play** option in the **Settings>System>More** menu is not important, in Image Search mode it will function anyway.*

CEC and CEC RC Passthrough

This function allows to control the CEC-enabled devices, that are connected through HDMI ports by using the remote control of the Display.

The **CEC** option in the **Settings>System>More** menu should be set as **Enabled** at first. Then, select the HDMI input of the connected CEC device. When new CEC source device is connected, it will be listed in source menu with its own name instead of the connected HDMI ports name (such as DVD Player, Recorder 1 etc.).

The Display remote is automatically able to perform the main functions after the connected HDMI source has been selected. To terminate this operation and control the Display via the remote again, press and

hold the "0-Zero" button on the remote control for 3 seconds.

You can disable the CEC functionality by setting the related option under the **Settings>System>More** menu accordingly.

Audio Return Channel

The Display supports ARC (Audio Return Channel). This feature is an audio link meant to replace other cables between the Display and an audio system (A/V receiver or speaker system).

When ARC is active, the Display does not mute its other audio outputs automatically. You will need to decrease Display volume to zero manually if you wish to hear the ARC audio only (same as optical or co-axial digital audio outputs). If you want to change connected device's volume level, you should select that device from the source list. In that case volume control keys are directed to connected audio device.

Note : ARC can only operate with HDMI1.

System Audio Control

Allows an Audio Amplifier/Receiver to be used with the Display. The volume can be controlled using the remote control of the Display. To activate this feature set the **Speakers** option in the **Settings>System>More** menu as **Amplifier**. The Display speakers will be muted and the sound of the watched source will be provided from the connected sound system.

*Note: The audio device should support System Audio Control feature and **CEC** option should be set as **Enabled**.*

Settings Menu Content

Menu that cannot be adjusted is greyed out or hidden.

Adjustable menu changes depending on signal, input and menu setting

Picture Menu Content	
Mode	You can change the picture mode to suit your preference or requirements. Picture mode can be set to one of these options: Text, Game, Sports, Signage and Natural . Note: Not apply for PC input.
Contrast	Adjusts the light and dark values on the screen.
Brightness	Adjusts the brightness values on the screen.
Sharpness	Sets the sharpness value for the objects displayed on the screen.
Colour	Sets the colour value, adjusting the colours.
Tint	Adjust hue of skin colour. Reddish <--> Greenish Note: Not apply for PC input
Energy Saving	This Display is designed to be environmentally friendly. If you set this option to Minimum, Medium, Maximum or Auto the Display will reduce energy consumption by regulating the backlight level accordingly. If you like to set the backlight level to a fixed value set as Custom and adjust the Backlight (located under this setting) manually using Left or Right buttons on the remote. Set as Off to turn this setting off. If pressed Right button while Auto option is selected or Left button while Custom option is selected, " Screen will be off in 15 seconds. " message will be displayed on the screen. Select Proceed and press ENTER to turn the screen off immediately. If you don't press any button, the screen will be off in 15 seconds. Press any button on the remote or on the Display to turn the screen on again. When the Display is not in use, please switch off or disconnect the Display from the mains plug. This will also reduce energy consumption. Note: Available options may differ depending on the selected Mode.
Backlight	This setting controls the backlight level. The backlight function will be inactive if the Energy Saving is set to an option other than Custom .
Advanced Settings	
Dynamic Contrast	You can change the dynamic contrast ratio to desired value. Off Low Medium High.
Noise Reduction	If the signal is weak and the picture is noisy, use the Noise Reduction setting to reduce the amount of noise. Off Low Medium High.
Colour Temp	Sets the desired colour temperature value. 10700K, 9300K, 6500K options are available.
Aspect	Sets the desired image size format. Full, 16:9, 14:9, 4:3, Cinema, Auto for except PC , 16:9,4:3 for PC
Picture Shift	This option may be available depending on the Aspect setting. Highlight and press ENTER , then use directional buttons to shift the picture upwards or downwards. Operate only Cinema Press the ENTER key and move the screen up and down with the up and down keys
Film Mode	Films are recorded at a different number of frames per second. Turn this feature on when you are watching films to see the fast motion scenes clearly.
Skin Tone	Skin tone can be changed between -5 and 5.
RGB Gain	Adjust the strength of the red, green and blue colours. You can use this feature for fine adjustment of white balance in the picture.
HDMI Full Range	While watching from a HDMI source, this feature will be visible. You can use this feature to enhance blackness in the picture.

Edge Smoother	Edge Smoother setting allows you to adjust the edge smoothness. Off, Low, Medium, High
PC Position	Auto Setup: When inputting a PC signal, [H position] / [V position], [Dot Clock] and [Clock Phase] are automatically corrected. H position: Adjust the horizontal position. V position: Adjust the vertical position. Dot Clock: Periodic striped pattern interference (noise) may occur when a striped pattern is displayed. If this happens, adjust so that any such noise is minimized. Clock Phase: In some cases, frame of the screen appears blurred or smudged, when PC signal is input. Note: Available with PC input.
Reset	Resets the picture settings to factory default settings (except Game mode).

Sound Menu Content	
Volume	Adjusts the volume level.
Equalizer	Selects the equalizer mode. Custom settings can be made only when in User mode. Note: Equalizer is enabled when Dolby Audio off.
Balance	Adjusts whether the sound comes from the left or right speaker.
Audio Out	Sets Audio Out volume. Please ensure before using Audio devices that the Audio Out volume is set to a low level, to prevent damage to your hearing
AVL (Automatic Volume Limiting)	Sets the sound to obtain fixed output level between sources. If the Dolby Audio menu item is set to an option other than Off the AVL setting options will change. Auto , Night , Normal and Off options will be available. In Auto mode the display will switch to Normal or Night mode automatically according to the current time information. If no time information is available this option will always function as Normal . When the display switches to Night mode for the first time after setting this option as Auto , an information bar will pop up on the screen. Please note that compared to Normal mode Night mode provides more aggressive dynamic compression control which is suitable for silent environments.
Dynamic Bass	Enables or disables the Dynamic Bass.
Dolby Audio	Smart , Movie , Music , News and Off options will be available. Set as Off to disable. <i>Note: Some items in Sound menu will be grayed out and unavailable if set to an option other than Off.</i>
Surround Sound	Surround sound mode can be changed as On or Off . Note: Surround is enabled when Dolby Audio off.
Digital Out	Sets digital out audio type. PCM Compressed and Paththrough options are available.

Network Menu Content	
Network Type	Disable the network connection or change the connection type. Note: If Network Type is changed, Network>Advanced Settings are reset.
Scan Wireless Networks	Start a search for wireless networks. This option will be available if the Network is set as Wireless Device .
Press WPS on your Wi-Fi router	If your modem/router device has WPS, you can directly connect to it using this option. Highlight this option and press ENTER . Go to your modem/router device and press the WPS button on it to make the connection. This option will be available if the Network Type is set as Wireless Device .

Internet Speed Test	Start a speed test to check your connection bandwidth. The result will be displayed on the screen when finished.
Advanced Settings	Change the IP and DNS configurations of your Display.
Wake On	Enable or disable this feature by setting it as On or Off .
Administrator Account	Configure the administrator account settings.
Command control	Set when controlling with the unit's LAN terminal. [Off]: Invalidates control with LAN terminal. [On]: Controls via LAN using the LAN terminal.
Command port	Set the port number used for command control. The available setting range is 1024 – 65535.
Crestron Connected™	<p>When this function is set to [On], the Display can be displayed or controlled via the network using equipment and application software of Crestron Electronics, Inc. This Display supports the following application software from Crestron Electronics, Inc.</p> <ul style="list-style-type: none"> • RoomView Express • Crestron Fusion <p>Crestron Connected is a function to connect to a system developed by Crestron Electronics, Inc. which manages and controls multiple system devices connected to the network.</p> <ul style="list-style-type: none"> • For details of Crestron Connected, refer to the Crestron Electronics, Inc. web site (Provided only in English). http://www.crestron.com/ <p>For the download of "RoomView Express", refer to the Crestron Electronics, Inc. web site (Provided only in English). (https://www.crestron.com/en-US/resources/getroomview)</p> <p>Note:</p> <ul style="list-style-type: none"> • To set the setting to [On], you must configure [Administrator account] in advance. - Flash UI which is served by the display device is not supported. Flash UI which is served by the control system can be used. Flash UI will not be directly connected to display device but will be connected indirectly over control system in this case. - Wireless Display source is not visible to the Crestron Connected interfaces (e.g. Roomview, Xpanel). The reason is when we select this source the connection is broken and therefore could not communicate with crestron devices again.
PJLink Settings	<p>Specifies the PJLink communication settings.</p> <p>[PJLink control]: Off: Disables PJLink control. On: Enables PJLink control.</p> <p>[PJLink password]: Set PJLink password.</p> <p>[PJLink notification]: Off: Disables PJLink notification function. On: Enables PJLink notification function.</p> <p>[Notified IP Address 1][Notified IP Address 2]: IP Address of the computer to notify the status of the display</p>

SNMP settings	<p>Sets the various items for SNMP. SNMP (Simple Network Management Protocol) is a protocol to manage devices connected to the network.</p> <p>If the SNMP manager is used for connection, the information of the target device can be obtained, and its settings can be changed.</p> <p>[Snmp Username]: Enter the user name of SNMP v3.</p> <p>[Permission]: Select whether to obtain only information via SNMP v3 or to both obtain information and make the setting.</p> <p>[Security Level]: Select the security level for SNMP v3.</p> <p>[Authentication Protocol]: Select the authentication method for SNMP v3 from SHA1 and MD5.</p> <p>[Authentication Password]: Set the authentication password of SNMP v3.</p> <p>[Privacy Protocol]: Select the encryption method for SNMP v3 from AES and DES.</p> <p>[Privacy Password]: Set the encryption password of SNMP v3.</p>
Display Name	The name of the Display that is shown on the network can be changed.
Reset	Resets the Network settings to factory default settings.
<p><i>Note: For detailed information on the options of this menu refer to the Connectivity section.</i></p> <p><i>Power off and on is needed to activate the new setting if they are not activated.</i></p>	

Signage Menu Content	
Device Info	
Display ID	Sets the device ID. You can select a value between 0-99 using the numeric buttons on the remote in order to identify your Display.
Serial ID Function	Set to control external control with the PC connected to SERIAL terminal according to the Display's ID number.
Software upgrade	Displays current software version. Press ENTER to see the upgrade options. You can use these options to start a manual search for software updates and set your automatic scan preference.
Serial number	Displays serial number of the unit. (Cannot be changed by user)
Model name	Displays model name of the unit. (Cannot be changed by user)
Save model information	Copies the model information data of the unit to a connected USB device.
Display Life Time	Displays the duration of life of the unit
Controls	
OSD Orientation	<p>Sets the OSD (On Screen Display) rotation of your Display. Landscape, Portrait 1 and Portrait 2 options are available.</p> <p>Note: CQE1 is not applicable for portrait installation. A portrait installation may cause a defect.</p>
Pixel Shift	Automatically shifts the display image to prevent image retention on the liquid crystal panel. Setting this to [On] moves the screen position at certain intervals and displays the images.

<p>No Signal</p>	<p>Sets the behavior preference of the Display, when no signal is detected from the currently set input source. Image Search and Input Search options are available.</p> <p>If Image Search is selected the Display checks the connected USB device for available files to play. If no playable files are available or there is no USB device connected to the Display, the No Signal image will be displayed. If there isn't any No Signal Image available, No Signal OSD will be displayed on the screen. The setting of the USB Auto Play option in the Settings>System>More menu is not important, in Image Search mode it will function anyway.</p> <p>If Input Search is selected the Display will search all available input sources consecutively to find signal. If no signal is detected from other available sources, No Signal OSD will be displayed and the Display will turn itself off after a period of 30 seconds.</p> <p>How to install No Signal Image</p> <p>Install the file you want to use onto the root directory of any USB storage device and name it as "NoSignalImage.png". Connect the USB storage device to the Display. Highlight USB Operations option in the Settings>Signage>USB menu and press ENTER.</p>
<p>No Signal Delay</p>	<p>Sets a delay value to the 'No Signal' preferences when the Display is in No Signal state. After the set delay time is expired 'No Signal' preferences will be applied. If the No Signal option is set as Input Search, this option will not be available.</p>
<p>No Signal Power Off</p>	<p>When enabled the Display will turn itself off after a period of 5 minutes, if no signal is received from the selected source.</p> <p>This feature will only work if all of the following circumstances occur:</p> <ul style="list-style-type: none"> - No Signal option is set as Image Search. - USB device is not connected to the Display / USB device is connected but there are no playable files installed on the USB device. <p>If the No Signal option is set as Input Search, this option will not be available.</p>
<p>Control Button Lock</p>	<p>Set as Off to prohibit the use of the buttons on the Display.</p>
<p>Remote Controller Lock</p>	<p>Set as On to inhibit the use of the remote. Remote control will function in Stand-By mode independently from the setting of this option.</p> <p>To turn this option off and be able to use the remote again, press MENU/M-1-9-7-3 buttons on the remote consecutively. Signage menu will appear. Enter the Controls menu and set this option as Off.</p> <p>Note: The Standby button is valid even if set to On.</p>
<p>Menu lock</p>	<p>You can block the usage of the menu button on the remote by setting this item as All menus. When you press the menu button, you will be asked to enter the PIN that you have defined in the First Time Installation. Set as Off to disable this function.</p>
<p>Auto Source Switch</p>	<p>If this option is enabled the Display will switch to the currently active HDMI source automatically when a device is connected to the Display through the HDMI1 or HDMI2 input terminal. Set as Enabled to enable this feature.</p> <p>When the HDMI source is removed the Display will switch to other active HDMI source. If there isn't any other device connected to the Display and the HDMI Wake UP option for the related HDMI source is enabled the Display will switch into the standby mode.</p> <p>There is also a 3-second restriction for the successive connected HDMI sources. This means, second HDMI device must be plugged in 3 seconds after the first HDMI device is plugged in.</p> <p>Note: This feature applies for HDMI1 and HDMI2 input terminals only. Refer to the General View section to see the HDMI inputs.</p>
<p>Power Up Settings</p>	
<p>Initial startup</p>	<p>Configures the power up mode preference. Last State, Always On and Standby options are available.</p>

Quick Standby	<p>If this feature is enabled the Display can be turned on again with the RS232 and LAN commands if it is turned off through it. Press Left or Right button to enable or disable the feature.</p> <p>The Quick standby turns on the power quickly when the power is turned on. ON: The power is turned on quickly when the power is turned on. Off: The power is turned on normally when the power is turned on.</p> <p><i>Note : When this setting is "On", the idle power consumption becomes higher.</i></p>
Power on Delay	<p>Sets a delay value at power on. This value can be set from 0 to 2000 ms in steps of 100 ms. The Display will turn on after the set delay time is expired.</p>
Auto Launch	<p>Configures the auto launch preference. Open Browser(Open Browser initial page) and Disabled options are available.</p>
Boot Up Picture Mode	<p>Configures the picture mode preference at power on. If set as Off the last set picture mode will be used at power on.</p>
HDMI1 Wake Up	<p>If this option is set as Enabled, the Display will turn on with the HDMI1 input source, when it is switched on. This feature works based on HDMI 5V signal. When this signal is active the Display wakes up and when the signal is inactive the Display shuts down. You can disable this option by setting as Disabled. In order to use this feature in conjunction with the Auto Source Switch feature it is recommended to enable the Auto Source Switch option in the Signage>Controls menu.</p> <p>If any Scheduler is set this option will be inactive and can not be set as Enabled.</p>
HDMI2-HDMI3-HDMI4 Wake Up	<p>If this option is set as Enabled, the Display will turn on with the active input source (HDMI2, HDM3 or HDMI4 depending on which input source is active), when it is switched on. This feature works based on HDMI 5V signal. When this signal is active the Display wakes up and when the signal is inactive the Display shuts down. You can disable this option by setting as Disabled. In order to use this feature in conjunction with the Auto Source Switch feature it is recommended to enable the Auto Source Switch option in the Signage>Controls menu.</p> <p>If any Scheduler is set this option will be inactive and can not be set as Enabled.</p> <p><i>Note: If multiple devices are connected to the Display through HDMI input sockets, this feature will not work. The Display wakes up even if an input other than the last input is active.</i></p>

USB							
Clone to USB	Copies the database files from the unit to a connected USB device.						
Clone from USB	Copies the database files from a connected USB device to the unit.						
Copy app cache from USB	Copies app cache data from a connected USB device to the unit. <i>Note: This feature may not be available depending on the model of your unit.</i>						
USB Information	Press ENTER to open the USB information menu screen. Current Total space and Free space information of the connected USB device will be displayed. You can also format the connected USB device using the Format Disk option in this menu (FAT32 format only).						
USB Operations	Highlight and press ENTER to perform USB operations. The feature that uses this item is as follow. - Settings>Signage>Controls>No Signal						
USB Option	Set as Off to disable the USB ports on the Display. You can also set this option as 5V to provide 5 volts power over USB. In this case it will still not be available to browse the USB content via Media Browser feature of the Display.						
Safely Remove	You can use this option to remove the devices connected to the USB inputs of the Display safely. Highlight this option and press ENTER . Wait for the message to be displayed on the screen indicating that you can remove your device and then remove your device. Failure to do so, may cause problems when you connect your USB device to other devices and you might have to format your USB device.						
Video Wall Settings	<p>Press ENTER to open the Video Wall Settings menu screen. Video Wall Settings, Row Count, Column Count, Cell and Offset options are available.</p> <p>Video Wall Settings: Enable or disable the Video Wall function by pressing Left/Right directional buttons.</p> <p>Row count: Adjust the number of Video Wall “rows” by pressing Left/Right directional buttons. The maximum number that can be set is 10.</p> <p>Column count: Adjust the number of VideoWall “columns” by pressing Left/Right directional buttons. The maximum number that can be set is 10.</p> <p>Cell: Each Video Wall unit is called “Cell”. Adjust the number of a cell by pressing Left/Right directional buttons. The maximum number that can be set is 100. In order to disable video wall function of the unit and display the image in full-screen mode, the Cell option should be set as 0.</p> <p>Offset: Offset setting is used to adjust the refractions at the sides of the picture depending on the bezel thickness between Video Wall units (Cells). The maximum number that can be set is 50.</p> <p>For example; For a 2x3 video wall matrix, Row count option should be set as 2 and Column count option should be set as 3. Numbers of the cells in a video wall matrix will be determined as shown in the template below. If you are setting the Display, which is positioned same as the Display with the number 1 in this template, then the Cell option should be set as 1 for this Display.</p> <div style="text-align: center;"> <table border="1" style="margin: auto;"> <tr> <td style="width: 40px; height: 40px; text-align: center;">1</td> <td style="width: 40px; height: 40px; text-align: center;">2</td> <td style="width: 40px; height: 40px; text-align: center;">3</td> </tr> <tr> <td style="width: 40px; height: 40px; text-align: center;">4</td> <td style="width: 40px; height: 40px; text-align: center;">5</td> <td style="width: 40px; height: 40px; text-align: center;">6</td> </tr> </table> </div>	1	2	3	4	5	6
1	2	3					
4	5	6					

SLOT Settings

Press **ENTER** to open the **SLOT Settings** menu screen. Three sub-menu options are available.

SLOT Status: Displays whether the SLOT module is on or off. Allows the change of status via soft PSON signal (0.5s)

Boot Signal: Enables or disables sending of a PSON signal. The Display checks the status signal of the SLOT at bootup in order to turn it on by sending a PSON signal if it is off. Some SLOT's send incorrect information on their status during the bootup of the Display, so they seem to be on even though they are off. For such non-standard SLOT's, this option must be enabled. In this case, a PSON signal will be send for the SLOT regardless of the received status information at bootup.

Powerdown: Turns the SLOT off via hard PSON signal (5s)

Recovery Mode: When this option is enabled and SLOT is on, if there is no video for 10 seconds it resets hotplug. If there is no video available after 30 seconds it reboots SLOT.

SLOT Always on: When this option is enabled, **Quick Standby** will be forced to enabled and greyed out in the menu and SLOT will not be set to standby.

Note: This menu will not be available if SLOT is not supported or not connected to the unit.

<p>Scheduler Settings</p>	<p>Using the scheduler options you can set the unit to turn on automatically at defined time intervals with the defined input source setting on the desired days of the week. Press ENTER to open the Scheduler Settings menu screen. You can set up to 4 different schedulers.</p> <p>Highlight the first checkbox of the desired scheduler option and check it by pressing the ENTER button. Now you will be able to define a time for the Display to be turned on automatically. Highlight the time box next to the first checkbox and press the ENTER button, then use the directional and numeric buttons on the remote to set a time. Press the ENTER button again when you are done.</p> <p>Perform the same steps to set a time for the Display to turn off.</p> <p>You can also define a source for your scheduler. Highlight the box located under the Source tab for your scheduler option and press the ENTER button, then set as desired using the Left/Right directional buttons. If the Source option is set as Last Source, the input source will not be changed at the power-up. If the Source option is set as USB, the media files in the connected USB device will be played back automatically as explained in the section entitled 'USB Auto Play Feature'.</p> <p>If the Source option is set as USB, the media files in the connected USB device will be played back automatically as explained in the section entitled 'USB Auto Play Feature'.</p> <p>In this scenario, if source USB is selected in the Scheduler Settings menu, the scheduler will show playlist options. The user can create 3 different playlists. When the scheduler is activated, the playlist scenario is started. During the autoplay, the selected playlist is checked first. If the selected playlist is not available in USB, the default playlist file is checked. If the default playlist file is not found, it works just like the USB Auto play scenario. When the "Playlist Selection" menu is selected, the operation is performed according to the file name described below.</p> <p>File name (selection item): playlist.txt(Default), playlist1.txt(Playlist1), playlist2.txt(Playlist2), playlist3.txt(Playlist3)</p> <p>Lastly, you can select the week day/s for your scheduler setting to be activated. Highlight the checkbox under the desired day tab and press ENTER to check. Highlight and press ENTER a second time to uncheck a box. The scheduler will be active on the checked days of the week.</p> <p>You can also set a backlight scheduler. After setting the On, Off, Source and day options highlight the checkbox under the Backlight column and press ENTER. The checkbox will be checked and backlight level setting screen will be displayed. Set On value and Off value using the sliders and then press ENTER to save. Mind that, in case you set a backlight scheduler, the display will not be turned on or off, only the backlight values will be changed at defined time interval. If Source option is set as Last Source the backlight settings will be applied to all sources, otherwise the settings will be applied to the selected source only.</p> <p>Press the Green button on the main scheduler screen to save settings when complete.</p>
<p>Link options</p>	<p>Press ENTER to open the link options menu screen. Open browser initial page and NTP server link preferences can be configured using the related options.</p>
<p>Volume Settings</p>	<p>Press ENTER to see available menu options.</p>
<p>Reset to Default Values</p>	<p>Highlight this option and press the ENTER button on the remote to return the Display to default settings.</p>
<p>Shipping</p>	<p>Highlight and press ENTER to perform Shipping and reset all settings to factory settings. You will need to enter the correct PIN to carry out this operation. <i>Note: Enter the PIN you have defined during the First Time Installation process.</i></p>

System Menu Content	
Language	Sets the OSD menu language preference.
Date/Time	Sets date and time.
Sources	<p>Enables or disables selected source options. There will be Regular, Enhanced and Disabled options available for HDMI sources, if your Display supports Ultra HD. Regular and Enhanced options are affecting the colour settings of the selected HDMI source. To be able to watch 4K images from an HDMI source related source setting should be set as Enhanced if the connected device is HDMI 2.0 compatible. Set as Regular if the connected device is HDMI 1.4 compatible. Set accordingly or disable the related HDMI source by setting as Disabled.</p> <p><i>Note: HDMI cables which are longer than 5 metres and which are not HDMI certified can cause display problems. We recommend using a certified Premium High-Speed HDMI Cable. Source device, connection cable quality and other HDMI equipments used may affect performance.</i></p> <p><i>Please refer to → https://www.hdmi.org/consumer/finding_right_cable.aspx (for finding the right cable) https://www.hdmi.org/installers/longcablelengths.aspx (for cable lengths)</i></p>
More	Displays other setting options of the Display.
Menu Timeout	Changes timeout duration for menu screens.
Software upgrade	Displays current software version. Press ENTER to see the upgrade options. You can use these options to start a manual search for software updates and set your automatic scan preference.
No Activity Power Off	Sets the desired time for the Display to automatically go into standby mode when not being operated.
CEC	With this setting you can enable and disable CEC functionality completely. Press Left or Right button to enable or disable the feature.
CEC Auto Power On	This function allows the connected HDMI-CEC compatible device to turn on the Display and switch to its input source automatically. Press Left or Right button to enable or disable the feature.
Speakers	<p>You can select the audio volume control destination using remote control. If Amplifier menu item is set, you can control Audio Amplifier/Receiver with the Display using the remote control.</p> <p>Note: The audio device should support System Audio Control feature and CEC option should be set as Enabled.</p>
DisplayPort Stream Setting (*)	<p>Sets the DisplayPort stream type. MST and SST options are available.</p> <p><i>(*) This menu item appears only when the input source is set to DisplayPort.</i></p>
USB Auto Play	Using this option you can set your Display to start playing the media content installed on a removable device automatically. Refer to USB Auto Play Feature section for detailed information.
Software Licenses	Display the software license.
Adapter Name	<p>Connection device name setting.</p> <p>Note: Available with Wireless Display input.</p>

- Video equipment and HDMI cable shown are not supplied with this unit.
- Connect the equipment complying with the HDMI standard.
- Some HDMI equipment may not be able to display picture.
- This Display does not support VIERA LINK.
- Use an HDMI High Speed cable complying with the HDMI standards.

Note: When inputting 4K video signals exceeding the transmission speed supported by an HDMI High Speed cable, use an HDMI cable supporting 18 Gbps high-speed transmission such as the one certified as a Premium

HDMI cable. When inputting video signals exceeding the transmission speed supported by the HDMI cable you are using, malfunction may occur such as interrupted pictures and no display on the screen.

Connectivity

To configure wired or wireless settings you should access the **Network** menu in the **Settings** menu.

Wired Connectivity

To Connect to a Wired Network

- You must have a modem/router connected to an active broadband connection.
- There is a LAN port at the bottom of the rear side of your Display. Connect your Display to your modem/router via this LAN port using an Ethernet cable.

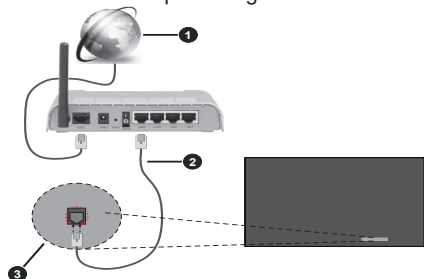

- 1 Broadband ISP connection
- 2 LAN (Ethernet) cable
- 3 LAN input on the bottom of the rear side of the Display

Configuring Wired Device Settings

Network Type

Set the **Network Type** as **Wired Device** if you are connecting via an Ethernet cable.

Internet Speed Test

Highlight **Internet Speed Test** and press the **ENTER** button. Display will check the internet connection bandwidth and display the result when complete.

Advanced Settings

Highlight **Advanced Settings** and press the **ENTER** button. On the next screen you can change the IP and DNS settings of the Display. Highlight the desired one and press Left or Right button to change the setting from **Automatic** to **Manual**. Now you can enter the **Manual IP** and / or **Manual DNS** values. Select the related item in the drop down menu and enter the new values using the numeric buttons on the remote. Highlight **Save** and press the **ENTER** button to save settings when complete.

Other Information

You can also enable or disable Wake On feature using the related option. The status of the connection will be displayed as **Connected** or **Not Connected** and the current IP and MAC addresses, if a connection is established.

Wireless Access Point

If the network type is set as **Wired Device** access point feature will be available. Highlight **Access Point** option and press **ENTER**. **Access Point**, **SSID**, **Security Type** and **Password** options will be available.

Access Point: Start or stop access point functionality. The function of this option will change according to the current status.

SSID: Set the name of the accesspoint.

Security Type: Secure your network using **WPA2 PSK**. You can also set this option as **None**. In that case no password will be required to connect to the access point. This option can be set only if the access point feature is not activated.

Password: Define a password for the access point. This option will be available if the **Security Type** option is set as **WPA2 PSK** and can be set only if the access point feature is not activated.

Notes on Using Wired LAN

When setting up the Display at a place, where electric static occurs often, take a sufficient antistatic measure before start using.

- When the Display is used at a location, where static electricity occurs often, such as on a carpet, a wired LAN communication is disconnected more often. In that case, remove static electricity and the noise source that may cause problems with an antistatic mat, and re-connect the wired LAN.
- In rare cases, the LAN connection is disabled due to static electricity or noise. In that case, turn off the power of the Display and the connected devices once and then re-turn on the power.

The Display may not work properly due to strong radio wave from the boardcast station or the radio.

- If there is any facility or equipment, which outputs strong radio wave, near the installation location, set up the Display at a location sufficiently far from the source of the radio wave. Or wrap the LAN cable connected to the LAN terminal by using a piece of metal foil or a metal

pipe, of which is grounded at both ends.

Wireless Connectivity

To Connect to a Wireless Network

- You must have a wireless modem/router connected to an active broadband connection.

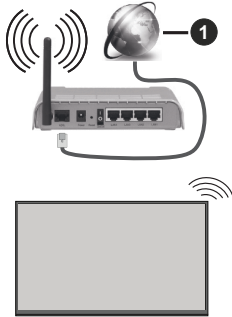

1 Broadband ISP connection

- A Wireless-N router (IEEE 802.11a/b/g/n) with simultaneous 2.4 and 5 GHz bands is designed to increase bandwidth. These are optimized for smoother and faster HD video streaming, file transfers and wireless gaming.
- The frequency and channel differ depending on the area.
- The transmission speed differs depending on the distance and number of obstructions between the transmission products, the configuration of these products, the radio wave conditions, the line traffic and the products that you use. The transmission may also be cut off or may get disconnected depending on the radio wave conditions, DECT phones or any other WLAN 11b appliances. The standard values of the transmission speed are the theoretical maximum values for the wireless standards. They are not the actual speeds of data transmission.
- The location where the transmission is most effective differs depending on the usage environment.
- The Wireless feature of the Display supports 802.11 a,b,g & n type modems. It is highly recommended that you should use the IEEE 802.11n communication protocol in order to avoid any possible problems while watching videos.
- You must change your modem's SSID when there are any other modems around with the same SSID. You can encounter connection problems otherwise. Use a wired connection if you experience problems with a wireless connection.

Configuring Wireless Device Settings

Open the **Network** menu and select **Network Type** as **Wireless Device** to start connection process.

Highlight **Scan Wireless Networks** option and press **ENTER** to start a search for available wireless networks. All found networks will be listed. Highlight your desired network from the list and press **ENTER** to connect.

Note: If the modem supports N mode, you should set N mode settings.

If the selected network is password-protected, enter the correct key by using the virtual keyboard. You can use this keyboard via the directional buttons and the **ENTER** button on the remote control.

Wait until the IP address is shown on the screen.

This means that the connection is now established. To disconnect from a wireless network, highlight **Network Type** and press Left or Right buttons to set as **Disabled**.

If your router has WPS, you can directly connect to the modem/router without entering a password or adding the network first. Highlight **Press WPS on your Wi-Fi router** option and press **ENTER**. Go to your modem/router device and press the WPS button on it to make the connection. You will see a connection confirmation on your Display once the devices have paired. Select **ENTER** to proceed. No further configuration is required.

Highlight **Internet Speed Test** and press the **ENTER** button to check your internet connection speed. Highlight **Advanced Settings** and press the **ENTER** button to open the advanced setting menu. Use directional and numeric buttons to set. Highlight **Save** and press the **ENTER** button to save settings when complete.

Other Information

You can also enable or disable Wake On feature using the related option. The status of the connection will be displayed as **Connected** or **Not Connected** and the current IP and MAC addresses, if a connection is established.

Wake ON

Wake-on-LAN (WoL) and Wake-on-Wireless LAN (WoWLAN) are technologies that allow a device to be turned on or woken up by a network message (magic packet). This message is sent to the device by a program executed on a remote device connected to the same local area network, such as a smartphone.

Your Display is WoL and WoWLAN compatible. To enable this feature set the **Wake On** option in the **Settings/Network** menu as **On** and set the **Quick Standby** option in the **Signage>Power Up Settings** menu as **Disabled**. It is necessary that both the

device, from which the network message will be sent to the Display, and the Display are connected to the same network. All devices must support magic packet on the system from Access Points to the device which sends the magic packet and the device which receives the magic packet to wake-up. You can use any Wake-on-LAN software available for the operating system of your device in order to send magic packets.

How to control functionality

- Enable **Wake On** option from **Settings>Network** menu by settings as **On**
- Connect your Display and the remote device, which will send the magic packets to the Display, to the same network
- Get the MAC address of your Display which will be needed in order to send magic packets
- Switch the Display into standby mode
- Send magic packets to the MAC address of your Display by using mobile phones, Linux or Windows computers

Your Display should wake up after receiving magic packets.

Wireless Display

Wireless Display is a standard for streaming video and sound content. This feature provides the ability to use your Display as wireless display device.

Using with mobile devices

There are different standards which enable sharing of screens including graphical, video and audio content between your mobile device and Display.

(For 98/86inch model)

Plug in the WLAN USB dongle to Display first.

(For other inch model)

WLAN USB dongle is built into the display.

Plug in the WLAN USB dongle to Display first, then press the **Wireless Display** button on the remote and switch to **Wireless Display** source.

A screen appears stating that the Display is ready for connection.

Open the sharing application on your mobile device. These applications are named differently for each brand, refer to the instruction manual of your mobile device for detailed information.

Scan for devices. After you select your Display and connect, the screen of your device will be displayed on your Display.

Note: This feature can be used only if the mobile device supports this feature. If you experience problems with the connection check if the operating system version you use supports this feature. There may be incompatibility problems with the operating system versions which are released after

the production of this Display. Scanning and connecting processes differ according to the programme you use. The maximum supported resolution is 1920x1080. Image quality may be affected by neighbouring wireless networks and your internet connection speed.

The network connection settings may be initialized when you finish this feature. In that case, please check Network > Advanced Settings.

Connectivity Troubleshooting

Wireless Network Not Available

- Ensure that any firewalls of your network allow the Display wireless connection.
- Try searching for wireless networks again, using the **Network** menu screen.

If the wireless network does not function properly, try using the wired network. Refer to the **Wired Connectivity** section for more information on the process.

If the Display does not function using the wired connection, check the modem (router). If the router does not have a problem, check the internet connection of your modem.

Connection is Slow

See the instruction book of your wireless modem to get information on the internal service area, connection speed, signal quality and other settings. You need to have a high speed connection for your modem.

Distruption during playback or slow reactions

You could try the following in such a case:

Keep at least three meters distance from microwave ovens, mobile telephones, bluetooth devices or any other WLAN compatible devices. Try changing the active channel on the WLAN router.

Internet Connection Not Available

If the MAC address (a unique identifier number) of your PC or modem has been permanently registered, it is possible that your Display might not connect to the internet. In such a case, the MAC address is authenticated each time when you connect to the internet. This is a precaution against unauthorized access. Since your Display has its own MAC address, your internet service provider cannot validate the MAC address of your Display. For this reason, your Display cannot connect to the internet. Contact your internet service provider and request information on how to connect a different device, such as your Display, to the internet.

It is also possible that the connection may not be available due to a firewall problem. If you think

this causes your problem, contact your internet service provider. A firewall might be the reason of a connectivity problem.

Apps

You can access the applications installed on your Display from **Apps** menu. Highlight an app and press **ENTER** to launch.

Notes:

Possible application dependent problems may be caused by the content service provider.

Third party internet services may change, be discontinued or restricted at any time.

Internet Browser

To use the internet browser enter the **Apps** menu first. Then launch the internet browser application which has an orange coloured logo with earth symbol on it.

() The appearance of the internet browser logo may change*

In the initial screen of the browser, the thumbnails of the predefined (if any) links to web sites available will be displayed as **Speed Dial** options along with the **Edit Speed Dial** and the **Add to Speed Dial** options.

You can select internet browser in Apps menu to open the initial internet browser page.

If the **Open browser initial page** URL in the **Settings>Signage>Link Options** menu is defined, the browser will open on this page. Otherwise this button will not be functional.

To navigate the web browser, use the directional buttons on the remote or a connected mouse. To see the browser options bar, move the cursor to the top of the page. **History**, **Tabs** and **Bookmarks** options and the browser bar which contains previous/next buttons, the refresh button, the address/search bar, the **Speed Dial** and the **Vewd** buttons are available.

To add a desired website to the **Speed Dial** list for quick access, move the cursor to the top of the page. The browser bar will appear. Highlight the **Speed Dial** -  button and press the **ENTER** button. Then select **Add to Speed Dial** option and press the **ENTER** button. Fill in the blanks for **Name** and **Address**, highlight **ENTER** and press the **ENTER** button to add. Whilst you are on the site you wish to add to the **Speed Dial** list, highlight the **Vewd** button and press the **ENTER** button. Then highlight **Add to Speed Dial** option in the submenu and press the **ENTER** button again. **Name** and **Address** will be filled automatically according to the site you are visiting. Highlight **ENTER** and press the **ENTER** button to add.

You can also use the **Vewd** menu options to manage the browser. Highlight the **Vewd** button and press

the **ENTER** button to see available page specific and general options.

There are various ways to search or visit websites using the web browser.

Enter the address of a website(URL) into the search/address bar and highlight the **Submit** button on the virtual keyboard and press the **ENTER** button to visit the site.

Enter keyword/s into the search/address bar and highlight the **Submit** button on the virtual keyboard and press the **ENTER** button to start a search for the related websites.

Highlight a Speed Dial thumbnail and press the **ENTER** button to visit the related website.

Your Display is compatible with USB keyboard/mice. Plug your device into the USB input of your Display for easier and quicker navigation.

Some web pages include flash content. These are not supported by the browser.

Your Display does not support any download processes from the internet via the browser.

All sites on the internet might not be supported. According to the site; content problems may occur. In some circumstances video contents might not be able to be played.

OSD Rotation Support

You can change the OSD (On Screen Display) rotation of your Display if desired. While performing **First time installation** set the **OSD Orientation** option as desired when the **Signage** menu is displayed. You can also change this setting later from the **Signage>Controls** menu. Available options are: **Landscape**, **Portrait 1** and **Portrait 2**.

DisplayPort

DisplayPort version 1.2 is supported via the DisplayPort input and output connectors on your Display.

DisplayPort Stream Setting option in the **Settings>System>More** menu is set as **MST**(Multi-Stream Transport) by default. If a MST compliant source device is connected to the Display, the streaming data should be configured on the source device (Daisy-chaining).

If DisplayPort version 1.1 compliant or SST (Single-Stream Transport) compliant source device with DisplayPort version 1.2 support is connected to the Display, DisplayPort output on the Display will work as a splitter. In this case, same image will be displayed in all connected Displays.

To be able to stream the same image to all connected Displays using a MST compliant device, **DisplayPort Stream Setting** option in the **Settings>System>More** menu should be set as **SST**.

The maximum amount of the Displays that can be connected by using daisy-chaining function may differ depending on the source device's capacity. The image that will be displayed in all Displays will be defined by the source device. For example, to be able to stream 4 different FHD images, the source device should be capable of supporting this operation.

Note: It is recommended to use a DisplayPort certified cable for connection.

When using cascade-connected Displays, it is recommended to set the **DisplayPort Stream Setting** as **SST** on all Displays in **SST** operation mode.

For proper operation in **MST** operation mode make sure your source device is **MST** compliant. If your source device is a computer check the specifications of its graphic card to ensure **MST** compatibility. When using daisy-chained Displays, it is recommended to set the **DisplayPort Stream Setting** as **MST** on all Displays in **MST** operation mode.

USB-C

Multiple protocols and power delivery up to 5V@1.5A are supported via USB-C receptacle on your display. USB Type-C features are compatible with the devices that meet the USB-Type-C-Specification. 4K video stream (if the source supports DisplayPort alternate mode), USB 2.0 data transmission and 5V@1.5A power delivery are supported through the USB-C connection that handle the plug orientation.

Note: It is recommended to use Electronically Marked USB-C to USB-C cable for video stream over Type-C connection. Also e-marked USB-C to USB-A cable can be used for data transmission.

Real Time Clock (RTC)

Your Display has an RTC. It is used to maintain the real date and time information for a period of time if the energy supply is interrupted by separating the Display from the mains or by a power blackout. In this case the Display will use the date and time information stored in RTC.

- All time sources are able to override RTC date/time.
- Display tries to connect to the **NTP server** periodically (6 hours after last update) to get the current date and time information. If the Display successfully gets these informations from the NTP server, it updates itself and RTC with the received date and

time information. If the NTP server update fails, the Display uses RTC time and date to update itself.

- The RTC battery provides power to the integrated real-time clock and the calendar. Without any external power source, RTC is able to function for a minimum of 14 days.
- If RTC is used as time source, manual date-time set is enabled from **Date/Time** option in the **Settings>System** menu.

Serial IN Terminal Connection

The SERIAL terminal conforms to the RS-232C interface specification, so that the Display can be controlled by a computer which is connected to this terminal.

Note: Additional computer and cables shown are not supplied with this set.

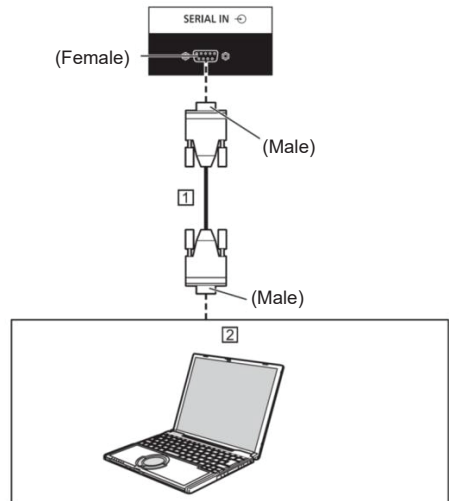

1 D-sub 9p RS-232C Straight cable (commercially available)

2 PC

Note : Select the RS-232C straight cable for communication used for connecting SERIAL terminal and computer according to the computer you are using.

Pin assignments and signal names for SERIAL Terminal

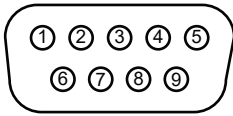

Pin No.	Signal Name	
1	NC (Not connected)	
2	RXD	
3	TXD	
4	Non Use	
5	GND (Ground)	
6	Non Use	
7	RTS	Shorted in this set
8	CTS	
9	NC (Not connected)	

These signal names are those of computer specifications.

Communication parameters

Signal level: RS-232C compliant
 Synchronization method: Asynchronous
 Baud rate: 9 600 bps
 Parity: None
 Character length: 8 bits
 Stop bit: 1 bit
 Flow control: None

Basic format for control data

The transmission of control data from the computer starts with a STX signal, followed by the command, the parameters, and lastly an ETX signal in that order. Add parameters as required according to control details.

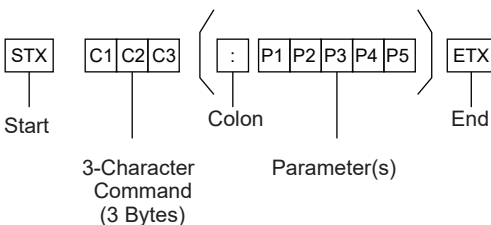

Command	Parameter	Control Details
PON	None	Power ON
POF	None	Power OFF
AVL	***	Volume 000-100
AMT	0	Audio MUTE OFF
	1	Audio MUTE ON
IMS	None	Input Select (toggle)
	HM1	HDMI1
	HM2	HDMI2
	HM3	HDMI3
	HM4	HDMI4
	DP1	DisplayPort
	SL1	SLOT
	PC1	PC
	UC1	USB- C
	WD1	Wireless Display
DAM	AUTO	Aspect mode select Auto
	FULL	Full
	1609	16:9
	1409	14:9
	0403	4:3
	CINM	Cinema

Note:

- If multiple commands are transmitted, be sure to wait for the response for the first command to come from this unit before sending the next command.
- If an incorrect command is sent by mistake, this unit will send an "ER401" command back to the computer.
- When sending a command which does not require parameter, a colon (:) is not needed.
- Consult your local Panasonic dealer for detail instructions on command usage.

For more details, visit the following web site.

<https://panasonic.net/cns/prodisplays/>

Control Command via LAN

Connection Method

1. Obtain the display's IP address and the Command port (Default is 1024), and request connection to the display.

The IP address and the port number can be obtained from the following menus.

•• IP address:

[Network] → [Advanced Settings] → [IP Configuration] or [Network]

•• Command Port

[Network] → [Command Port].

2. The display responds.

Response data

Data part	Space	Mode	Space	Random Number Part	Last Terminal Symbol
[NTCONTROL] (ASCII Character string)	[] 0x20	[1] 0x31	[] 0x20	[zzzzzz] (ASCII Code hex number)	(CR) 0x0d
9 Bytes	1 Byte	1 Byte	1 Byte	8 Bytes	1 Byte

Mode = 1 (Fixed)

3. Hash the following data with the MD5 algorithm, and generate a 32-byte hash value.

[xxxxxx:yyyyy:zzzzzzzz]

xxxxxx :

[Network] – [Administrator Account] – [User Name]

yyyyy :

[Network] – [Administrator Account] – [Password]

- Set the user name and password you set for [Administrator account].

zzzzzzzz :

8-byte random number obtained in step 2

Command transmission method

Transmit in the following command format

Transmitted data

Header			Data Part	Last Terminal Symbol
Hash value (see "Connection method")	'0' 0x30	'0' 0x30	Control command (ASCII character string)	(CR) 0x0d
32 Bytes	1 Byte	1 Byte	Undefined	1 Byte

Received data

Header		Data Part	Last Terminal Symbol
'0' 0x30	'0' 0x30	Control command (ASCII character string)	(CR) 0x0d
1 Byte	1 Byte	Undefined	1 Byte

Error response

Error message		Last Terminal Symbol
"ERR1"	: Undefined control command	(CR) 0x0d
"ERR2"	: Out of parameter range	
"ERR3"	: Busy status or reception invalid period	
"ERR4"	: Timeout or reception invalid period	
"ERR5"	: Wrong data length	
"ERRA"	: Mismatching of password	
4 Bytes		1 Byte

Note

- With some of the commands, a part of character string of the transmitted data may not be included in the received data.
- Consult your local Panasonic dealer for detail instructions on command usage.

For more details, visit the following web site.

<https://panasonic.net/cns/prodisplays>

PJLink protocol

The unit's Network function is compatible with PJLink Class 1 & Class 2. The following operations can be performed from a computer when PJLink protocol is used.

- Setting the Display
- Querying the Display status

PJLink security authentication

Set the password used for PJLink on the dialog accessible through [PJLink password].

When using PJLink without security authorization, set None to [PJLink password].

- Concerning the specification of PJLink, see the web site of Japan Business Machine and Information System Industries Association (JBMA) below:

<http://pjlink.jbma.or.jp/english/index.html>

Preset Signals

This unit can display the video signals shown in the table below.

The contents of HDMI signal in the Plug and Play- supported signal column are as follows.

Corresponding Signal	Resolution (Dot)	Scanning Frequency		Dot Clock frequency (MHz)	Format*2	Plug and Play supported signal			
		Horizontal (kHz)	Vertical (Hz)			HDMI	DP*3	TypeC	VGA
480/60i	720(1440) x 480i *1	15,73	59,94	27	H/DP/TypeC	o	o	o	-
576/50i	720(1440) x 576i *1	15,63	50	27	H/DP/TypeC	o	o	o	-
480/60p	720 x 483	31,47	59,94	27	H/DP/TypeC	o	o	o	-
576/50p	720 x 576	31,25	50	27	H/DP/TypeC	o	o	o	-
720/60p	1280 x 720	45	60	74,25	H/DP/TypeC	o	o	o	-
720/50p	1280 x 720	37,5	50	74,25	H/DP/TypeC	o	o	o	-
1080/60i	1920 x 1080i	33,75	60	74,25	H/DP/TypeC	o	o	o	-
1080/50i	1920 x 1080i	28,13	50	74,25	H/DP/TypeC	o	o	o	-
1080/24p	1920 x1080	27	24	74,25	H/DP/TypeC	o	o	o	-
1080/25p	1920 x1080	28,13	25	74,25	H/DP/TypeC	o	o	o	-
1080/30p	1920 x1080	33,75	30	74,25	H/DP/TypeC	o	o	o	-
1080/60p	1920 x1080	67,5	60	148,5	H/DP/TypeC	o	o	o	-
1080/50p	1920 x1080	56,25	50	148,5	H/DP/TypeC	o	o	o	-
2K/24p	2048 x 1080	27	24	74,25	H/DP/TypeC	-	-	-	-
2K/25p	2048 x 1080	28,13	25	74,25	H/DP/TypeC	-	-	-	-
2K/30p	2048 x 1080	33,75	30	74,25	H/DP/TypeC	-	-	-	-
2K/48p	2048 x 1080	54	48	148,5	H/DP/TypeC	-	-	-	-
2K/60p	2048 x 1080	67,5	60	148,5	H/DP/TypeC	-	-	-	-
2K/50p	2048 x 1080	56,25	50	148,5	H/DP/TypeC	-	-	-	-
3840x2160/24p	3840 x 2160	54	24	297	H/DP/TypeC	o	o	o	-
3840x2160/25p	3840 x 2160	56,25	25	297	H/DP/TypeC	o	o	o	-
3840x2160/30p	3840 x 2160	67,5	30	297	H/DP/TypeC	o	o	o	-
3840x2160/60p	3840 x 2160	135	60	594	H/TypeC	o	-	o	-
3840x2160/50p	3840 x 2160	112,5	50	594	H/TypeC	o	-	o	-
4096x2160/24p	4096 x 2160	54	24	297	H/DP/TypeC	o	o	o	-
4096x2160/25p	4096 x 2160	56,25	25	297	H/DP/TypeC	o	o	o	-
4096x2160/30p	4096 x 2160	67,5	30	297	H/DP/TypeC	o	o	o	-
4096x2160/60p	4096 x 2160	135	60	594	H/TypeC	o	-	o	-
4096x2160/50p	4096 x 2160	112,5	50	594	H/TypeC	o	-	o	-
640x400/70	640 x 400	31,47	70,09	25,18	H/DP/TypeC/VGA	-	-	-	-
640x400/85	640 x 400	37,86	85,08	31,5	H/DP/TypeC	-	-	-	-
640x480/60	640 x 480	31,47	59,94	25,18	H/DP/TypeC/VGA	o	o	o	o
640x480/67	640 x 480	35	66,67	30,24	H/DP/TypeC/VGA	-	-	-	-
640x480/73	640 x 480	37,86	72,81	31,5	H/DP/TypeC/VGA	-	-	-	-
640x480/75	640 x 480	37,5	75	31,5	H/DP/TypeC/VGA	-	-	-	-

640x480/85	640 x 480	43,27	85,01	36	H/DP/TypeC/VGA	-	-	-	-
800x600/56	800 x 600	35,16	56,25	36	H/DP/TypeC/VGA	-	-	-	-
800x600/60	800 x 600	37,88	60,32	40	H/DP/TypeC/VGA	o	o	o	o
800x600/72	800 x 600	48,08	72,19	50	H/DP/TypeC/VGA	-	-	-	-
800x600/75	800 x 600	46,88	75	49,5	H/DP/TypeC/VGA	-	-	-	-
800x600/85	800 x 600	53,67	85,06	56,25	H/DP/TypeC/VGA	-	-	-	-
832x624/75	832 x 624	49,72	74,55	57,28	H/DP/TypeC/VGA	-	-	-	-
852x480/60	852 x 480	31,47	59,94	34,24	H/DP/TypeC	-	-	-	-
1024x768/50	1024 x 768	39,55	50	51,89	H/DP/TypeC	-	-	-	-
1024x768/60	1024 x 768	48,36	60	65	H/DP/TypeC/VGA	o	o	o	o
1024x768/70	1024 x 768	56,48	70,07	75	H/DP/TypeC/VGA	-	-	-	-
1024x768/82	1024 x 768	65,55	81,63	86	H/DP/TypeC/VGA	-	-	-	-
1024x768/85	1024 x 768	68,68	85	94,5	H/DP/TypeC/VGA	-	-	-	-
1066x600/60	1066 x 600	37,64	59,94	53	H/DP/TypeC	-	-	-	-
1152x864/60	1152 x 864	53,7	60	81,62	H/DP/TypeC/VGA	-	-	-	o
1152x864/70	1152 x 864	63,99	70,02	94,2	H/DP/TypeC/VGA	-	-	-	-
1152x864/75	1152 x 864	67,5	75	108	H/DP/TypeC/VGA	-	-	-	-
1152x864/85	1152 x 864	77,09	85	119,65	H/DP/TypeC/VGA	-	-	-	-
1152x870/75	1152 x 870	68,68	75,06	100	H/DP/TypeC/VGA	-	-	-	-
1280x720/60	1280 x 720	44,76	60	74,48	H/DP/TypeC/VGA	-	-	-	o
1280x768/50	1280 x 768	39,55	49,94	65,18	H/DP/TypeC	-	-	-	-
1280x768/60	1280 x 768	47,7	60	80,14	H/DP/TypeC	-	-	-	-
1280x768/60	1280 x 768	47,78	59,87	79,5	H/DP/TypeC/VGA	-	-	-	-
1280x800/50	1280 x 800	41,2	50	68,56	H/DP/TypeC	-	-	-	-
1280x800/60	1280 x 800	49,31	59,91	71	H/DP/TypeC	-	-	-	-
1280x800/60	1280 x 800	49,7	59,81	83,5	H/DP/TypeC	-	-	-	o
1280x960/60	1280 x 960	60	60	108	H/DP/TypeC/VGA	-	-	-	-
1280x960/85	1280 x 960	85,94	85	148,5	H/DP/TypeC	-	-	-	-
1280x1024/60	1280 x 1024	63,98	60,02	108	H/DP/TypeC/VGA	o	o	o	o
1280x1024/75	1280 x 1024	79,98	75,02	135	H/DP/TypeC/VGA	-	-	-	-
1280x1024/85	1280 x 1024	91,15	85,02	157,5	H/DP/TypeC/VGA	-	-	-	-
1360x768/60	1360 x 768	47,71	60,02	85,5	H/DP/TypeC	-	-	-	-
1360x768/60	1360 x 768	47,7	60	84,72	H/DP/TypeC	-	-	-	-
1360x768/60	1360 x 768	47,72	59,8	84,75	H/DP/TypeC	-	-	-	-
1366x768/50	1366 x 768	39,55	50	69,92	H/DP/TypeC	-	-	-	-
1366x768/60	1366 x 768	48,39	60,03	86,71	H/DP/TypeC	-	-	-	-
1366x768/60	1366 x 768	48	60	72	H/DP/TypeC	-	-	-	-
1366x768/50	1366 x 768	39,56	49,89	69	H/DP/TypeC	-	-	-	-
1366x768/60	1366 x 768	47,71	59,79	85,5	H/DP/TypeC/VGA	-	-	-	-
1400x1050/60	1400 x 1050	65,22	60	122,61	H/DP/TypeC	-	-	-	-
1400x1050/75	1400 x 1050	82,2	75	155,85	H/DP/TypeC/VGA	-	-	-	-
1440x900/60	1440 x 900	55,47	59,9	88,75	H/DP/TypeC	-	-	-	-
1440x900/60	1440 x 900	55,92	60	106,47	H/DP/TypeC/VGA	-	-	-	-
1600x900/50	1600 x 900	46,3	50	97,05	H/DP/TypeC	-	-	-	-

1600x900/60	1600 x 900	60	60	108	H/DP/TypeC	-	-	-	○
1600x900/60	1600 x 900	55,99	59,95	118,25	H/DP/TypeC	-	-	-	-
1600x900/60	1600 x 900	55,92	60	119	H/DP/TypeC	-	-	-	-
1600x1200/60	1600 x 1200	75	60	162	H/DP/TypeC/VGA	-	-	-	○
1680x1050/60	1680 x 1050	65,29	59,95	146,25	H/DP/TypeC	-	-	-	-
1920x1080/60	1920 x 1080	66,59	59,93	138,5	H/DP/TypeC	-	-	-	-
1920x1080/60	1920 x 1080	67,5	60	148,5	H/DP/TypeC/VGA	○	○	○	○
1920x1200/60	1920 x 1200	74,04	59,95	154	H/DP/TypeC/VGA	○	○	○	○

*1: Pixel-Repetition signal (dot clock frequency 27.0 MHz) only

*2: Signals to represent formats are as follows.

H : HDMI (HDMI 1, 2, 3, 4)

DP : Display Port

TypeC : USB-C

VGA : D-sub RGB

*3: Only for SQE1W

*4: Signals with ○ in the Plug and Play-supported signal column are the ones written in EDID (Extended Display

Identification Data) of this unit.

For signals without ○ in the Plug and Play-supported signal column, resolutions may not be selected on the PC

side even if this unit supports those signals.

Note

- An auto detected signal format may be differently displayed from the actual input signal.
- [i] shown after the number of dots of resolution means the interlace signal.

Supported Media Formats From USB

Video File Formats

Video Codec	Resolution	Bit Rate	Container
MPEG1/2	1080P@60fps	40Mbps	MPEG program stream (.DAT, .VOB, .MPG, .MPEG), MPEG transport stream (.ts, .trp, .tp), MP4 (.mp4, .mov), 3GPP (.3gpp, .3gp), AVI (.avi), MKV (.mkv), ASF (.asf)
MPEG4			MPEG program stream (.MPG, .MPEG), MP4 (.mp4, .mov), 3GPP (.3gpp, .3gp), AVI (.avi), MKV (.mkv), ASF (.asf)
XviD			MP4 (.mp4, .mov), AVI (.avi), MKV (.mkv), ASF (.asf)
Sorenson H.263			FLV (.flv), AVI (.avi)
H.263			MP4 (.mp4, .mov), 3GPP (.3gpp, .3gp), AVI (.avi), MKV (.mkv)
H.264	3840x2160@30fps, 1080P@60fps	135Mbps	FLV (.flv), MP4 (.mp4, .mov), 3GPP (.3gpp, .3gp), MPEG transport stream (.ts, .trp, .tp), ASF (.asf), AVI (.avi), MKV (.mkv)
Motion JPEG	720P@30fps	10Mbps	AVI (.avi), 3GPP (.3gpp, .3gp), MP4 (.mp4, .mov), MKV (.mkv), ASF (.asf)
VP8	1080P@30fps	20Mbps	MKV (.mkv), WebM (.webm)
HEVC/H.265	4K2K@60fps	100Mbps	MP4 (.mp4, .mov), MKV (.mkv), MPEG transport stream (.ts, .trp, .tp)
	1080P@60fps	50Mbps	MP4 (.mp4, .mov), MKV (.mkv), MPEG transport stream (.ts, .trp, .tp), 3GPP (.3gpp, .3gp)
VP9	4K2K@30fps	100Mbps	MKV (.mkv), WebM (.webm)

Picture File Formats

Image	Photo	Resolution (width x height)	Remark
JPEG	Base-line	15360x8640	The limit for max resolution depends on DRAM size
	Progressive	1024x768	
PNG	non-interlace	9600x6400	
	interlace	1200x800	
BMP		9600x6400	

Audio File Formats

Audio Codec	Sample rate	Bit Rate	Container
MPEG1/2 Layer1	16KHz ~ 48KHz	32Kbps ~ 448Kbps	MP3 (.mp3), AVI (.avi), ASF (.asf), Matroska (.mkv, .mka), MPEG transport stream (.ts, .trp, .tp), MPEG program stream (.DAT, .VOB, .MPG, .MPEG), WAV (.wav)
MPEG1/2 Layer2	16KHz ~ 48KHz	8Kbps ~ 384Kbps	MP3 (.mp3), AVI (.avi), ASF (.asf), Matroska (.mkv, .mka), MPEG transport stream (.ts, .trp, .tp), MPEG program stream (.DAT, .VOB, .MPG, .MPEG), WAV (.wav)
MPEG1/2 Layer3	16KHz ~ 48KHz	8Kbps ~ 320Kbps	MP3 (.mp3), AVI (.avi), ASF (.asf), Matroska (.mkv, .mka), 3GPP (.3gpp, .3gp), MP4 (.mp4, .mov, m4a), MPEG transport stream (.ts, .trp, .tp), MPEG program stream (.DAT, .VOB, .MPG, .MPEG), FLV (.flv), WAV (.wav)

AC3	32KHz, 44.1KHz, 48KHz	32Kbps ~ 640Kbps	AC3 (.ac3), AVI (.avi), Matroska (.mkv, .mka), 3GPP (.3gpp, .3gp), MP4 (.mp4, .mov, m4a), MPEG transport stream (.ts, .trp, .tp), MPEG program stream (.DAT, .VOB, .MPG, .MPEG)
EAC3	32KHz, 44.1KHz, 48KHz	32Kbps ~ 6 Mbps	EAC3 (.ec3), 3GPP (.3gpp, .3gp), MP4 (.mp4, .mov, m4a), MPEG transport stream (.ts, .trp, .tp), MPEG program stream (.DAT, .VOB, .MPG, .MPEG)
AAC, HEAAC	8KHz ~ 48KHz		AAC (.aac), AVI (.avi), Matroska (.mkv, .mka), 3GPP (.3gpp, .3gp), MP4 (.mp4, .mov, m4a), MPEG transport stream (.ts, .trp, .tp), MPEG program stream (.DAT, .VOB, .MPG, .MPEG), FLV (.flv), RM (.ra)
WMA	8KHz ~ 48KHz	128bps ~ 320Kbps	ASF (.wma, .asf), AVI (.avi), Matroska (.mkv, .mka)
WMA 10 Pro M0	48KHz	< 192kbps	
WMA 10 Pro M1	48KHz	< 384kbps	
WMA 10 Pro M2	96KHz	< 768kbps	
G711 A/mu-law	8KHz	64Kbps ~ 128Kbps	WAV (.wav), AVI (.avi), Matroska (.mkv, .mka), 3GPP (.3gpp, .3gp), MP4 (.mp4, .mov, m4a)
LBR (cook)	8KHz, 11.025KHz, 22.05KHz, 44.1KHz	6Kbps ~ 128Kbps	RM (.ra)
FLAC	8KHz~96KHz	< 1.6Mbps	Matroska (.mkv, .mka)

Subtitle File Formats

Internal Subtitles		
Extension	Container	Subtitle Code
dat, mpg, mpeg, vob	MPG, MPEG	DVD Subtitle
ts, trp, tp	TS	DVB Subtitle
mp4	MP4	DVD Subtitle UTF-8 Plain Text
mkv	MKV	ASS SSA UTF-8 Plain Text VobSub DVD Subtitle
avi	AVI (1.0, 2.0), DMF0,1, 2	XSUB XSUB+

External Subtitles		
Extension	Subtitle Parser	Remark
.srt	Subrip	
.ssa/ .ass	SubStation Alpha	
.smi	SAMI	
.sub	SubViewer MicroDVD DVDSusbtileSystem SubIdx (VobSub)	SubViewer 1.0 & 2.0 Only
.txt	TMPlayer	

Note: Some files may not be played back even if their formats are supported as described here.

Wireless LAN Transmitter Specifications

Frequency Ranges	Max Output Power
2400 - 2483,5 MHz (CH1-CH13)	< 100 mW
5150 - 5250 MHz (CH36 - CH48)	< 200 mW
5250 - 5350 MHz (CH52 - CH64)	< 200 mW
5470 - 5725 MHz (CH100 - CH140)	< 200 mW

Country Restrictions

This device is intended for home and office use in all EU countries (and other countries following the relevant EU directive) without any limitation except for the countries mentioned below.

Country	Restriction
Bulgaria	General authorization required for outdoor use and public service
Italy	If used outside of own premises, general authorization is required
Greece	In-door use only for 5470 MHz to 5725 MHz band
Luxembourg	General authorization required for network and service supply(not for spectrum)
Norway	Radio transmission is prohibited for the geographical area within a radius of 20 km from the centre of Ny-Alesund
Russian Federation	In-door use only
Israel	5 GHz band only for 5180 MHz-5320 MHz range

The requirements for any country may change at any time. It's recommended that user checks with local authorities for the current status of their national regulations for 5 GHz wireless LAN's.

Specifications

Model No.

86- Inch Model	:	TH-86SQE1W TH-86CQE1W
75- Inch Model	:	TH-75SQE1W TH-75CQE1W
65- Inch Model	:	TH-65SQE1W TH-65CQE1W
55- Inch Model	:	TH-55SQE1W TH-55CQE1W
49- Inch Model	:	TH-49SQE1W TH-49CQE1W
43- Inch Model	:	TH-43SQE1W TH-43CQE1W

Power Consumption

86- Inch Model	:	TH-86SQE1W 364W (3.6-1.8A) TH-86CQE1W 364W (3.6-1.8A)
75- Inch Model	:	TH-75SQE1W 334W (3.3-1.7A) TH-75CQE1W 307W (3.0-1.5A)
65- Inch Model	:	TH-65SQE1W 281W (2.8-1.4A) TH-65CQE1W 224W (2.3-1.1A)
55- Inch Model	:	TH-55SQE1W 197W (1.9-0.9A) TH-55CQE1W 135W (1.3-0.7A)
49- Inch Model	:	TH-49SQE1W 186W (1.8-0.9A) TH-49CQE1W 115W (1.1-0.6A)

43- Inch Model

TH-43SQE1W 172W
(1.7-0.8A)
TH-43CQE1W 111W
(1.1-0.6A)

For all model

Power off with the Main power switch 0W
Stand-by condition 0.5 W

LCD Display Panel

86- Inch Model

86-inch IPS panel (Edge LED backlight),
16:9 aspect ratio

75- Inch Model

75-inch IPS panel (Direct LED backlight),
16:9 aspect ratio

65- Inch Model

65SQE1 : 65-inch IPS panel (Direct LED backlight)
, 16:9 aspect ratio

65CQE1 : 65-inch VA panel (Direct LED backlight)
, 16:9 aspect ratio

55- Inch Model

55-inch IPS panel (Direct LED backlight),
16:9 aspect ratio

49- Inch Model

49-inch IPS panel (Direct LED backlight),
16:9 aspect ratio

43- Inch Model

43-inch IPS panel (Direct LED backlight),
16:9 aspect ratio

No. of pixels

8,294,400

(3840 (Horizontal) x 2160 (Vertical))

Dimensions (W x H x D)

86- Inch Model

86SQE1:1929x1100x81 (top of VESA NUT:55)
(including remote controller sensor:1116mm)
75.91" x 43.28"x 3.16"(top of VESA NUT:2.15")
(including remote controller sensor: 43.94")
86CQE1:1929x1100x80 (top of VESA NUT:55)
(including remote controller sensor:1116mm)
75.91" x 43.28"x 3.13" (top of VESA NUT:2.15")
(including remote controller sensor: 43.94")

75- Inch Model

1684 x 968 x 100 (top of VESA NUT:73)
(including remote controller sensor:984mm)
66.28" x 38.09"x 3.92"(top of VESA NUT:2.89")
(including remote controller sensor:38.74")

65- Inch Model

65SQE1: 1460x842x96/ 57.46" x 33.12"x 3.77"
(including remote controller sensor:859mm / 33.82")
65CQE1: 1460x842x72 / 57.46" x 33.12"x2.83"
(including remote controller sensor:859mm / 33.82")

55- Inch Model

55SQE1: 1239x712x104/ 48.75" x 28.02"x 4.09"
(including remote controller sensor:730mm / 28.74")
55CQE1: 1239x712x82/ 48.75" x 28.02"x 3.19
(including remote controller sensor:730mm / 28.74")

49- Inch Model

49SQE1: 1102x635x105/ 43.37" x 24.98"x 4.11"
(including remote controller sensor:652mm / 25.67")
49CQE1: 1102x635x81/ 43.37" x 24.98"x 3.17"
(including remote controller sensor:652mm / 25.67")

43- Inch Model

43SQE1: 966x558x106/ 38.01" x 21.94"x 4.17"
(including remote controller sensor:576mm / 22.68")
43CQE1: 966x558x81 /38.01" x 21.94"x 3.17"
(including remote controller sensor:576mm / 22.68")

Mass

86- Inch Model

86SQE1: 62.9kg / 138.7lbs net
86CQE1: 61.7kg / 136.1lbs net

75- Inch Model

75SQE1:37.4kg / 82.5lbs net
75CQE1:36.8kg / 81.2lbs net

65- Inch Model

65SQE1:25.8kg / 56.9lbs net
65CQE1:25.2kg / 55.6lbs net

55- Inch Model

55SQE1: 17.2kg/38.0lbs net
55CQE1:16.2kg / 35.8lbs net

49- Inch Model

49SQE1:13.0 kg /28.7 lbs net
49CQE1:12.6 kg / 27.8 lbs net

43- Inch Model

43SQE1:10.3 kg / 22.7 lbs net
43CQE1: 9.9 kg /21.9 lbs net

Power Source

110 - 240 V ~ (110 – 240 V alternating current),
50/60 Hz

Operating Condition

Temperature

0 °C – 40 °C (32 °F – 104 °F)*1, 3

Environmental temperature to use this unit

- When using the unit where it is below 1400 m (4593 ft) above sea level : 0 °C to 40 °C (32 °F to 104 °F)
- When using the unit at high altitudes (1400 m (4593 ft) and higher and below 2800m (9186 ft) above sea level): 0 °C to 35 °C (32 °F to 95 °F)

Do not install the unit where it is 2800m (9186 ft) and higher above sea level

Humidity

20 % – 80 % (no condensation)

Storing Condition

Temperature

-20 °C – 60 °C (-4 °F – 140 °F)

Humidity

20 % – 80 % (no condensation)

Operating Time

24hours/day (SQE1W)

16hours/day (86/75/65/55/49/43CQE1W)

Sound

86-Inch Model	75-Inch Model
------------------	------------------

24W [12W + 12W] (10% THD)

65-Inch Model	55-Inch Model	49-Inch Model	43-Inch Model
------------------	------------------	------------------	------------------

16W [8W + 8W](10% THD)

Connection Terminals

HDMI 2.0 1,2,3,4 Input

Type A Connector x4 (Supports 4K)

Compatible HDCP 2.2

Audio signal : Linear PCM (Sampling frequency
48KHz, 44.1KHz, 32KHz)

PC IN

Mini D-Sub 15 pin (Compatible with DDC2B) x 1

RGB: 0.7Vp-p(75Ω)

HD/VD: TTL (High impedance)

USB

USB connector TYPEA x 3 , DC 5V/max0.5A

USB connector TYPEC x 1 , DC
5V/max1.5A

Audio IN

Pin Jack x 2(L/R) 0.5Vrms

Audio OUT

Stereo mini jack(M3) X1, 0.5Vrms

Output ; Variable (-∞~0dB)

(1kHz 0dB input, 10KΩ load)

Serial IN

Exteranal control terminal

D-sub 9pin x 1

RS232C compatible

LAN

RJ45 x 1

For network connection, compatible with PjLink
Communication method ; RJ45, 10BASE-
T/100BASE-TX

IR IN

Stereo mini jack (M3)

SPDIF Optical Out port

DisplayPort 1.2a IN (Only for SQE1W)

DisplayPort Terminal x 1

Compatible with HDCP 1.3

Audio signal : Linear PCM (Sampling frequency;
48KHz,44.1KHz,32KHz)

DisplayPort 1.2a OUT (Only for SQE1W)

DisplayPort Terminal x 1

Compatible with HDCP 1.3

Supply power for SLOT (Only for SQE1W)

12V x max 3.5A

RJ12 port (Service1) Only for service use







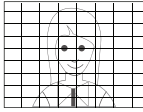
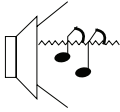

RJ12 port (Service2) Only for service use

Note

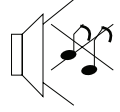
- Design and specifications are subject to change without notice. Mass and dimensions shown are approximate.

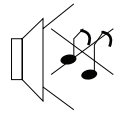
Troubleshooting

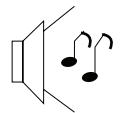
Before you call for service, determine the symptoms and make a few simple checks as shown below.

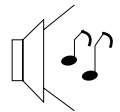
Symptoms		Check
<p>Picture</p>  <p>Interference</p>	<p>Sound</p>  <p>Noise Sound</p>	<p>Electrical Appliances Cars / Motorcycles Fluorescent light</p>
 <p>Normal Picture</p>	 <p>No Sound</p>	<p>Volume (Check whether the mute function has been activated on the remote control.) Audio input MP3 terminal (No sound will be output from the set speakers if connected.)</p>
 <p>No Picture</p>	 <p>No Sound</p>	<p>Not plugged into AC outlet Not switched on Picture and Brightness / Volume setting (Check by pressing the <Main Power On / Off button> or the <Standby (ON/OFF) button>)</p> <p>Note: Standby ON / OFF can be switched by pressing the power button on the remote control or pressing and holding the center of the joystick in located on the rear left side of the Displa for a few seconds.</p>
 <p>No Picture</p>	 <p>Normal Sound</p>	<p>If a signal with a non-applicable colour system format, or frequency is input, only the input terminal indication is displayed.</p>
 <p>No Colour</p>	 <p>Normal Sound</p>	<p>Colour controls set at minimum level</p>
<p>A Display error such a "no picture" occurs, or remote control operation is suddenly disabled.</p>		<p>This unit incorporates highly-advanced software. if you notice an abnormal operation such as "remote control cannot be operated" or "Display is disturbed", remove the power plug from the socket outlet, and insert it again after 5 seconds or more to turn the power on.</p>

Symptoms	Check
Power automatically turns off unexpectedly.	Check the settings of No Signal Power Off, [HDMI1 Wake UP], [HDMI2,3,4 Wake UP, and No Activity Power Off. Any of them may be set to [On(Enable)]. (see page **)
Can not turn on. The power LED flashes red and then goes off immediately.	There is possibility of malfunction. Please contact Authorized Service Centre.
No remote control operations can be performed.	<p>Check whether the batteries have discharged completely and, if they have not, whether they were inserted properly.</p> <p>Check whether the remote control sensor is exposed to an outdoor light or a strong fluorescent light.</p> <p>Check whether any obstacle is present between the remote control sensor and the remote control.</p> <p>Is the IR sensor cable of the IR_IN terminal disconnected?</p> <p>Check whether the remote control designed specifically for use with the unit is being used. (The unit cannot be operated by any other remote control.)</p> <p>Check whether [Remote Controller Lock] is set to [On].</p> <p>If the above doesn't help, the IR sensor may be broken.</p> <p>Please contact Authorized Service Centre.</p>
The top or bottom of the picture on the screen is cut off.	Depending on the aspect setting, the top, bottom, left, and right of the screen may be cut off. Please select your favorite aspect for the input source.
There are areas at the top and bottom of the screen where picture is not displayed	When using a video software program (such as a cinema size program) with a screen wider than one in the 16:9 mode, blank areas separate from the images are formed at the top and bottom of the screen.
Parts of the unit become hot.	Even when the temperature of parts of the front, top and rear panels has risen, these temperature rises will not pose any problems in terms of performance or quality.
There is no picture displayed or sound output sometimes.	<p>When HDMI etc. signals are input to the display using a selector or distributor, sound or images may not be output in the normal fashion depending on the selector or distributor used.</p> <p>The symptoms may be improved by turning the power off and on again, or by replacing the selector or distributor.</p>
Wake up without permission, or Wake up but no picture appears	<p>When Wake UP of HDMI2,3,4 is turned on, From standby, Wake UP works when 5V signal from HDMI is input to any of the terminals.</p> <p>The input source that was input first will be switched.</p> <p>Wake UP is not always done with the last input source.</p> <p>Some devices output 5V signals even when there is no video output.</p> <p>Please check if the video signal is output.</p> <p>All 5V signals of HDMI2,3,4 must be turned off to work standby.</p>
The RS-232C is uncontrollable	Check whether the connection has been made properly.

Symptoms	Check
The LAN is uncontrollable	<p>Check that the connection has been made properly. Check that [Network] is set properly. Check whether the [Administrator Account] is configured. The control with command control, check that [Settings] - [Network] - [Command control] is set to [ON]. When connecting to a device of Crestron Electronics, Inc., set [Crestron Connected™] according to the device to use.</p>
The file cannot be played back with "USB VIEWER"	Check the Supported Media Formats.
The screen darkens slightly when bright pictures with minimal movements are shown	<p>The screen will darken slightly when photos, still images of a computer or other pictures with minimal movements are shown for an extended period. This is done to reduce image retention on the screen and the shortening of the screen's service life: It is normal and not indicative of malfunctioning.</p>
It takes a while for the picture to appear	<p>The unit digitally processes the various signals in order reproduce esthetically pleasing images. As such, it sometimes takes a few moments for the picture to appear when the power has been turned on, when the input has been switched.</p>
The edges of the images flicker.	<p>Due to characteristics of the system used to drive the liquid crystal panel, the edges may appear to flicker in the fast-moving parts of the images: This is normal and not indicative of malfunctioning.</p>
There may be red spots, blue spots, green spots and black spots on the screen.	<p>This is a characteristic of liquid crystal panels and is not a problem. The liquid crystal panel is built with very high precision technology giving you fine picture details. Occasionally, a few non-active pixels may appear on the screen as fixed points of red, blue, green, or black. Please note this does not affect the performance of your LCD.</p>
 <p>Image retention appears</p>	<p>Image retention may occur. If you display a still picture for an extended period, the image might remain on the screen. However, it will dissappear when a general moving picture is displayed for a while. This is not considered as malfunction.</p>
Time difference between picture and sound	<p>This LCD Display uses special image processing, Hence a slight time lag may occur between image and audio depending on the type of input signal, However, this is not a malfunction.</p>

Mounting the display

Vesa Wall Mount Measurements

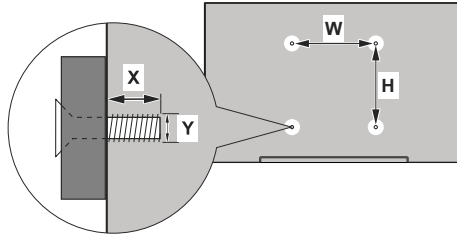

Inch	Hole Pattern Sizes (mm)		Screw Sizes	
	W	H	max. (mm)	Thread (Y)
86"	600	400	12	M8
75"	600	400	10	M8
65"	400	400	10	M6
55"	400	200	13	M6
49"	200	200	12	M6
43"	200	200	9	M6

Cautions when attaching wall mount and stand

For 55SQE1,49SQE1,43SQE1

There is convex shape near VESA holes on back cover. When attaching wall mount or stand, insert the spacers between them.

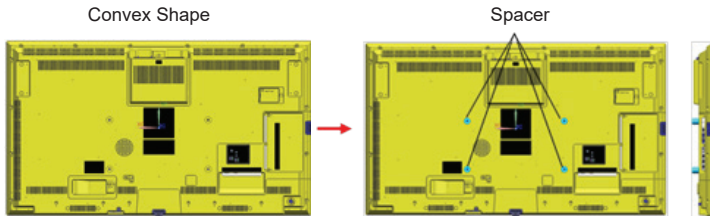

Note : For detailed dimensions, please refer to the CAD drawings on Panasonic website.

Installation On An Indented Wall

Operation of this unit is guaranteed up to an ambient temperature of 40°C(104°F). When installing the unit in a case or chassis, be sure to provide adequate ventilation with a cooling fan or ventilation hole so that the surrounding temperature (inside the case or chassis) including the temperature of the front surface of the liquid crystal panel can be kept at 40°C(104°F) or less.

If you can control only an ambient temperature outside of case or chassis, please keep following condition

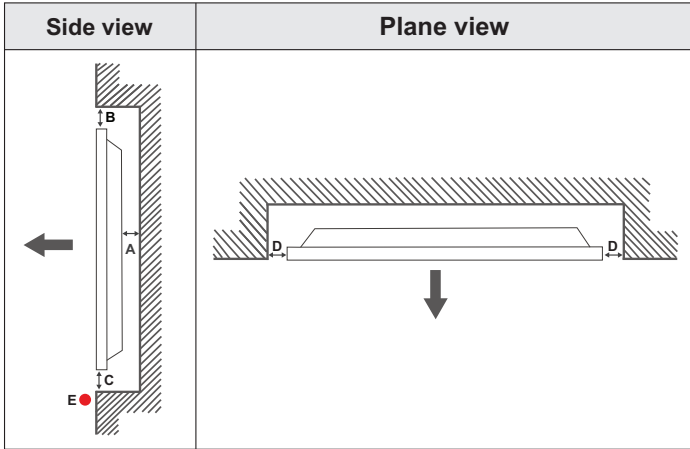

- A** Minimum 50 mm
- B** Minimum 70 mm
- C** Minimum 50 mm
- D** Minimum 50 mm
- E** Ambient temperature range: 0-35°C



When installing the product on an indented wall, allow at least the space specified above between the product and wall for ventilation and ensure that the ambient temperature is kept between 0°C-35°C.

Do not expose the product to direct sunlight.

We will take no responsibility for any damages or failures in case our products are not being used subject to these recommendations and/or instructions for use.

Cautions for portrait setting

When installing the display vertically, be sure that the terminals come to up for 75/65/55/49/43SQE1 and comes to down for 86SQE1.

75/65/55/49/43-inch

Terminals

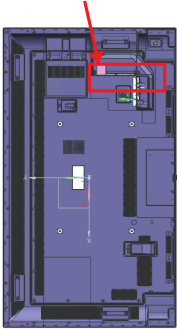

86-inch

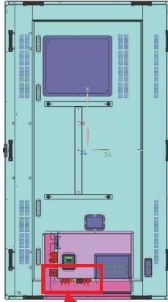

Terminals

Note

When installing the pedestal or wall hanging bracket, read the operating instructions supplied with it carefully and install properly. Also, always use the overturn prevention accessories.

We are not responsible for any product damage, etc. caused by failures in the installation environment for the pedestal or wall hanging bracket even during the warranty period.

License Notification

The terms HDMI and HDMI High-Definition Multimedia Interface, and the HDMI Logo are trademarks or registered trademarks of HDMI Licensing Administrator, Inc. in the United States and other countries.



Manufactured under license from Dolby Laboratories. Dolby, Dolby Audio and the double-D symbol are trademarks of Dolby Laboratories.



This product is protected by certain intellectual property rights of Microsoft Corporation. Use or distribution of such technology outside of this product is prohibited without a license from Microsoft or an authorized Microsoft subsidiary.

Software License

This product incorporates the following software:

- (1) the software developed independently by or for Panasonic Corporation,
- (2) the software owned by third party and licensed to Panasonic Corporation,
- (3) the software licensed under the GNU General Public License, Version 2.0 (GPL V2.0),
- (4) the software licensed under the GNU LESSER General Public License, Version 2.1 (LGPL V2.1), and/or
- (5) open source software other than the software licensed under the GPL V2.0 and/or LGPL V2.1.

The software categorized as (3) - (5) are distributed in the hope that it will be useful, but WITHOUT ANY WARRANTY, without even the implied warranty of MERCHANTABILITY or FITNESS FOR A PARTICULAR PURPOSE. For details, see the license conditions displayed by selecting [Software licenses], following the specified operation from the [Settings] menu of this product.

At least three (3) years from delivery of this product, Panasonic will give to any third party who contacts us at the contact information provided below, for a charge no more than our cost of physically performing source code distribution, a complete machine-readable copy of the corresponding source code covered under GPL V2.0, LGPL V2.1 or the other licenses with the obligation to do so, as well as the respective copyright notice thereof.

Contact Information:

oss-cd-request@gg.jp.panasonic.com

Notice about AVC/VC-1/MPEG-4

This product is licensed under the AVC Patent Portfolio License, VC-1 Patent Portfolio License and MPEG-4 Visual Patent Portfolio License for the personal use of a consumer or other uses in which it does not receive remuneration to (i) encode video in compliance with the AVC Standard, VC-1 Standard and MPEG-4 Visual Standard ("AVC/VC-1/MPEG-4 Video") and/or (ii) decode AVC/VC-1/MPEG-4 Video that was encoded by a consumer engaged in a personal activity and/or was obtained from a video provider licensed to provide AVC/VC-1/MPEG-4 Video. No license is granted or shall be implied for any other use. Additional information may be obtained from MPEG LA, LLC. See <http://www.mpegla.com>.

Disposal of Old Equipment and Batteries
Only for European Union and countries with recycling systems



These symbols on the products, packaging, and/or accompanying documents mean that used electrical and electronic products and batteries must not be mixed with general household waste. For proper treatment, recovery and recycling of old products and used batteries, please take them to applicable collection points in accordance with your national legislation.

By disposing of them correctly, you will help to save valuable resources and prevent any potential negative effects on human health and the environment.

For more information about collection and recycling, please contact your local municipality.

Penalties may be applicable for incorrect disposal of this waste, in accordance with national legislation.



Note for the battery symbol (bottom symbol)

This symbol might be used in combination with a chemical symbol. In this case it complies with the requirement set by the Directive for the chemical involved.

Information on Disposal in other Countries outside the European Union

These symbols are only valid in the European Union.

If you wish to discard these items, please contact your local authorities or dealer and ask for the correct method of disposal.

Notice (U.S.A. only)

Disposal may be regulated in your community due to environmental considerations. For disposal or recycling information, please visit Panasonic website:

<https://www.panasonic.com/us/corporate/sustainability.html>

or call 1-888-769-0149.

Customer's Record

The model number and serial number of this product may be found on its rear panel. You should note this serial number in the space provided below and retain this book, plus your purchase receipt, as a permanent record of your purchase to aid in identification in the event of theft or loss, and for Warranty Service purposes.

Model Number

Serial Number

Panasonic System Solutions Company of North America

Unit of Panasonic Corporation of North America

Executive Office :

Two Riverfront Plaza, Newark, New Jersey 07102

Panasonic Testing Centre

Panasonic Service Europe, a division of Panasonic Marketing Europe GmbH Winsbergring 15, 22525 Hamburg, F.R. Germany

Panasonic Corporation

Web Site: <http://panasonic.net/cns/prodisplays/>

© Panasonic Corporation 2020

English