

Latitude 5320

Service Manual

Notes, cautions, and warnings

 **NOTE:** A NOTE indicates important information that helps you make better use of your product.

 **CAUTION:** A CAUTION indicates either potential damage to hardware or loss of data and tells you how to avoid the problem.

 **WARNING:** A WARNING indicates a potential for property damage, personal injury, or death.

Chapter 1: Working on your computer	7
Safety instructions.....	7
Working inside your computer.....	7
After working inside your computer.....	11
Chapter 2: Removing and installing components	13
Recommended tools.....	13
Screw list.....	13
Major components of your system.....	16
SIM card tray.....	17
Removing the SIM card tray.....	17
Installing the SIM card tray.....	18
MicroSD card.....	19
Removing the micro-SD card.....	19
Installing the micro-SD card.....	20
Base cover.....	21
Removing the base cover.....	21
Installing the base cover.....	22
Battery.....	24
Lithium-ion battery precautions.....	24
Removing the battery.....	24
Installing the battery.....	25
Battery cable.....	26
Removing the battery cable.....	26
Installing the battery cable.....	27
WLAN card.....	28
Removing the WLAN card.....	28
Installing the WLAN card.....	29
WWAN card.....	30
Removing the WWAN card.....	30
Installing the WWAN card.....	31
Solid-state drive.....	32
Removing the M.2 2280 solid-state drive.....	32
Installing the M.2 2280 solid-state drive.....	33
Removing the M.2 2230 solid-state drive.....	34
Installing the M.2 2230 solid-state drive.....	35
Replacing the SSD securing rod.....	36
Speakers.....	37
Removing the speakers.....	37
Installing the speakers.....	38
Fan.....	40
Removing the fan.....	40
Installing the fan.....	41
Heat sink.....	42

Removing the heatsink.....	42
Installing the heatsink.....	43
System board.....	43
Removing the system board.....	43
Installing the system board.....	45
Power button with fingerprint reader (optional).....	47
Removing the power button with fingerprint reader (optional).....	47
Installing the power button with fingerprint reader (optional).....	48
Display assembly.....	49
Removing the display assembly (laptop).....	49
Installing the display assembly (laptop).....	52
Removing the display assembly (2-in-1).....	54
Installing the display assembly (2-in-1).....	56
Display bezel.....	58
Removing the display bezel.....	58
Installing the display bezel.....	60
Display panel.....	61
Removing the display panel.....	61
Installing the display panel.....	64
Display hinges.....	67
Removing the display hinges.....	67
Installing the display hinges.....	68
Display back cover assembly.....	69
Removing the display back-cover.....	69
Installing the display back-cover.....	70
eDP cable.....	71
Removing the eDP cable.....	71
Installing the eDP cable.....	72
Sensor board.....	73
Removing the sensor board.....	73
Installing the sensor board.....	74
LED board.....	74
Removing the LED board.....	74
Installing the LED board.....	75
Camera.....	76
Removing the camera.....	76
Installing the camera.....	77
Removing the infrared camera.....	78
Installing the infrared camera.....	79
Smart card reader.....	80
Removing the smart card reader (optional).....	80
Installing the smart card reader (optional).....	81
Keyboard.....	83
Removing the keyboard.....	83
Installing the keyboard.....	85
SIM card slot filler.....	88
Removing the SIM card slot filler.....	88
Installing the SIM card slot filler.....	88
Palm-rest and keyboard assembly.....	89
Removing the palmrest.....	89

Installing the palm-rest.....	90
Chapter 3: Drivers and downloads.....	92
Chapter 4: BIOS setup.....	93
BIOS overview.....	93
Entering BIOS setup program.....	93
Navigation keys.....	93
One time boot menu.....	94
BIOS setup.....	94
Overview.....	94
Boot configuration.....	95
Integrated Devices.....	96
Storage.....	98
Display.....	98
Connection options.....	99
Power management.....	99
Security.....	101
Password.....	102
Update and Recovery.....	103
System management.....	104
Keyboard.....	105
Pre-boot behavior.....	106
Virtualization support.....	106
Performance.....	107
System logs.....	107
Updating the BIOS.....	108
Updating the BIOS in Windows.....	108
Updating the BIOS in Linux and Ubuntu.....	108
Updating the BIOS using the USB drive in Windows.....	108
Updating the BIOS from the F12 One-Time boot menu.....	109
System and setup password.....	110
Assigning a system setup password.....	110
Deleting or changing an existing system setup password.....	110
Clearing BIOS (System Setup) and System passwords.....	111
Chapter 5: Troubleshooting.....	112
Handling swollen Lithium-ion batteries.....	112
Dell SupportAssist Pre-boot System Performance Check diagnostics.....	113
Running the SupportAssist Pre-Boot System Performance Check.....	113
Built-in self-test (BIST).....	113
M-BIST.....	113
LCD Power rail test (L-BIST).....	114
LCD Built-in Self Test (BIST).....	114
System diagnostic lights.....	115
Recovering the operating system.....	116
Real-Time Clock (RTC Reset).....	116
Updating the BIOS in Windows.....	116
Updating the BIOS using the USB drive in Windows.....	117

Backup media and recovery options..... 117
WiFi power cycle..... 117
Drain residual flea power (perform hard reset)..... 118

Chapter 6: Getting help and contacting Dell..... 119

Working on your computer

Topics:

- [Safety instructions](#)

Safety instructions

Use the following safety guidelines to protect your computer from potential damage and to ensure your personal safety. Unless otherwise noted, each procedure included in this document assumes that you have read the safety information that shipped with your computer.

⚠ WARNING: Before working inside your computer, read the safety information that is shipped with your computer. For more safety best practices, see the Regulatory Compliance home page at www.dell.com/regulatory_compliance.

⚠ WARNING: Disconnect your computer from all power sources before opening the computer cover or panels. After you finish working inside the computer, replace all covers, panels, and screws before connecting your computer to an electrical outlet.

⚠ CAUTION: To avoid damaging the computer, ensure that the work surface is flat, dry, and clean.

⚠ CAUTION: To avoid damaging the components and cards, handle them by their edges, and avoid touching the pins and the contacts.

⚠ CAUTION: You should only perform troubleshooting and repairs as authorized or directed by the Dell technical assistance team. Damage due to servicing that is not authorized by Dell is not covered by your warranty. See the safety instructions that is shipped with the product or at www.dell.com/regulatory_compliance.

⚠ CAUTION: Before touching anything inside your computer, ground yourself by touching an unpainted metal surface, such as the metal at the back of the computer. While you work, periodically touch an unpainted metal surface to dissipate static electricity which could harm internal components.

⚠ CAUTION: When you disconnect a cable, pull it by its connector or its pull tab, not the cable itself. Some cables have connectors with locking tabs or thumbscrews that you must disengage before disconnecting the cable. When disconnecting cables, keep them evenly aligned to avoid bending the connector pins. When connecting cables, ensure that the ports and the connectors are correctly oriented and aligned.

⚠ CAUTION: Press and eject any installed card from the media-card reader.

⚠ CAUTION: Exercise caution when handling Lithium-ion batteries in laptops. Swollen batteries should not be used and should be replaced and disposed properly.

ⓘ NOTE: The color of your computer and certain components may appear differently than shown in this document.

Working inside your computer

Before working inside your computer

About this task

ⓘ NOTE: The images in this document may differ from your computer depending on the configuration you ordered.

Steps

1. Save and close all open files and exit all open applications.
2. Shut down your computer. Click **Start > Power > Shut down**.

 **NOTE:** If you are using a different operating system, see the documentation of your operating system for shut-down instructions.

3. Disconnect your computer and all attached devices from their electrical outlets.
4. Disconnect all attached network devices and peripherals, such as keyboard, mouse, and monitor from your computer.

 **CAUTION:** To disconnect a network cable, first unplug the cable from your computer and then unplug the cable from the network device.

5. Remove any media card and optical disc from your computer, if applicable.

Electrostatic discharge—ESD protection

ESD is a major concern when you handle electronic components, especially sensitive components such as expansion cards, processors, memory DIMMs, and system boards. Very slight charges can damage circuits in ways that may not be obvious, such as intermittent problems or a shortened product life span. As the industry pushes for lower power requirements and increased density, ESD protection is an increasing concern.

Due to the increased density of semiconductors used in recent Dell products, the sensitivity to static damage is now higher than in previous Dell products. For this reason, some previously approved methods of handling parts are no longer applicable.

Two recognized types of ESD damage are catastrophic and intermittent failures.

- **Catastrophic** – Catastrophic failures represent approximately 20 percent of ESD-related failures. The damage causes an immediate and complete loss of device functionality. An example of catastrophic failure is a memory DIMM that has received a static shock and immediately generates a "No POST/No Video" symptom with a beep code emitted for missing or nonfunctional memory.
- **Intermittent** – Intermittent failures represent approximately 80 percent of ESD-related failures. The high rate of intermittent failures means that most of the time when damage occurs, it is not immediately recognizable. The DIMM receives a static shock, but the tracing is merely weakened and does not immediately produce outward symptoms related to the damage. The weakened trace may take weeks or months to melt, and in the meantime may cause degradation of memory integrity, intermittent memory errors, etc.

The more difficult type of damage to recognize and troubleshoot is the intermittent (also called latent or "walking wounded") failure.

Perform the following steps to prevent ESD damage:

- Use a wired ESD wrist strap that is properly grounded. The use of wireless anti-static straps is no longer allowed; they do not provide adequate protection. Touching the chassis before handling parts does not ensure adequate ESD protection on parts with increased sensitivity to ESD damage.
- Handle all static-sensitive components in a static-safe area. If possible, use anti-static floor pads and workbench pads.
- When unpacking a static-sensitive component from its shipping carton, do not remove the component from the anti-static packing material until you are ready to install the component. Before unwrapping the anti-static packaging, ensure that you discharge static electricity from your body.
- Before transporting a static-sensitive component, place it in an anti-static container or packaging.

ESD field service kit

The unmonitored Field Service kit is the most commonly used service kit. Each Field Service kit includes three main components: anti-static mat, wrist strap, and bonding wire.

Components of an ESD field service kit

The components of an ESD field service kit are:

- **Anti-Static Mat** – The anti-static mat is dissipative and parts can be placed on it during service procedures. When using an anti-static mat, your wrist strap should be snug and the bonding wire should be connected to the mat and to any bare metal on the system being worked on. Once deployed properly, service parts can be removed from the ESD bag and placed directly on the mat. ESD-sensitive items are safe in your hand, on the ESD mat, in the system, or inside a bag.

- **Wrist Strap and Bonding Wire** – The wrist strap and bonding wire can be either directly connected between your wrist and bare metal on the hardware if the ESD mat is not required, or connected to the anti-static mat to protect hardware that is temporarily placed on the mat. The physical connection of the wrist strap and bonding wire between your skin, the ESD mat, and the hardware is known as bonding. Use only Field Service kits with a wrist strap, mat, and bonding wire. Never use wireless wrist straps. Always be aware that the internal wires of a wrist strap are prone to damage from normal wear and tear, and must be checked regularly with a wrist strap tester in order to avoid accidental ESD hardware damage. It is recommended to test the wrist strap and bonding wire at least once per week.
- **ESD Wrist Strap Tester** – The wires inside of an ESD strap are prone to damage over time. When using an unmonitored kit, it is a best practice to regularly test the strap prior to each service call, and at a minimum, test once per week. A wrist strap tester is the best method for doing this test. If you do not have your own wrist strap tester, check with your regional office to find out if they have one. To perform the test, plug the wrist-strap's bonding-wire into the tester while it is strapped to your wrist and push the button to test. A green LED is lit if the test is successful; a red LED is lit and an alarm sounds if the test fails.
- **Insulator Elements** – It is critical to keep ESD sensitive devices, such as plastic heat sink casings, away from internal parts that are insulators and often highly charged.
- **Working Environment** – Before deploying the ESD Field Service kit, assess the situation at the customer location. For example, deploying the kit for a server environment is different than for a desktop or portable environment. Servers are typically installed in a rack within a data center; desktops or portables are typically placed on office desks or cubicles. Always look for a large open flat work area that is free of clutter and large enough to deploy the ESD kit with additional space to accommodate the type of system that is being repaired. The workspace should also be free of insulators that can cause an ESD event. On the work area, insulators such as Styrofoam and other plastics should always be moved at least 12 inches or 30 centimeters away from sensitive parts before physically handling any hardware components
- **ESD Packaging** – All ESD-sensitive devices must be shipped and received in static-safe packaging. Metal, static-shielded bags are preferred. However, you should always return the damaged part using the same ESD bag and packaging that the new part arrived in. The ESD bag should be folded over and taped shut and all the same foam packing material should be used in the original box that the new part arrived in. ESD-sensitive devices should be removed from packaging only at an ESD-protected work surface, and parts should never be placed on top of the ESD bag because only the inside of the bag is shielded. Always place parts in your hand, on the ESD mat, in the system, or inside an anti-static bag.
- **Transporting Sensitive Components** – When transporting ESD sensitive components such as replacement parts or parts to be returned to Dell, it is critical to place these parts in anti-static bags for safe transport.

ESD protection summary

It is recommended that all field service technicians use the traditional wired ESD grounding wrist strap and protective anti-static mat at all times when servicing Dell products. In addition, it is critical that technicians keep sensitive parts separate from all insulator parts while performing service and that they use anti-static bags for transporting sensitive components.

Transporting sensitive components

When transporting ESD sensitive components such as replacement parts or parts to be returned to Dell, it is critical to place these parts in anti-static bags for safe transport.

Service mode

Service Mode allows users to immediately cut off electricity from the system and conduct repairs without disconnecting the battery cable from the system board:

To enter the **Service Mode**:

1. Shut down the system and disconnect the AC adapter from the system.
2. Hold **** key on the keyboard press the power button for 3 seconds until the Dell logo appears on the screen. The system boots.



3. The following screen appears.

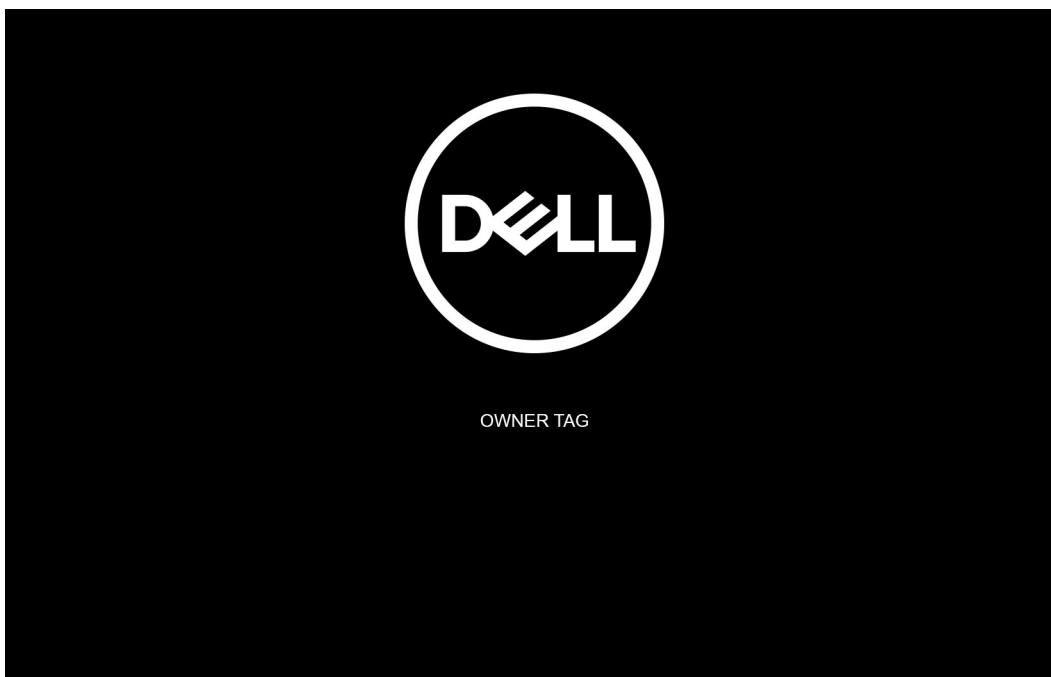

Press any key to continue.

i **NOTE:** The **Service Mode** procedure automatically skips this step if the Owner Tag of the system is not set up in advance by the manufacturer.

4. When the ready-to-proceed message appears on the screen, press any key to proceed. The system emits three short beeps and shuts down immediately.

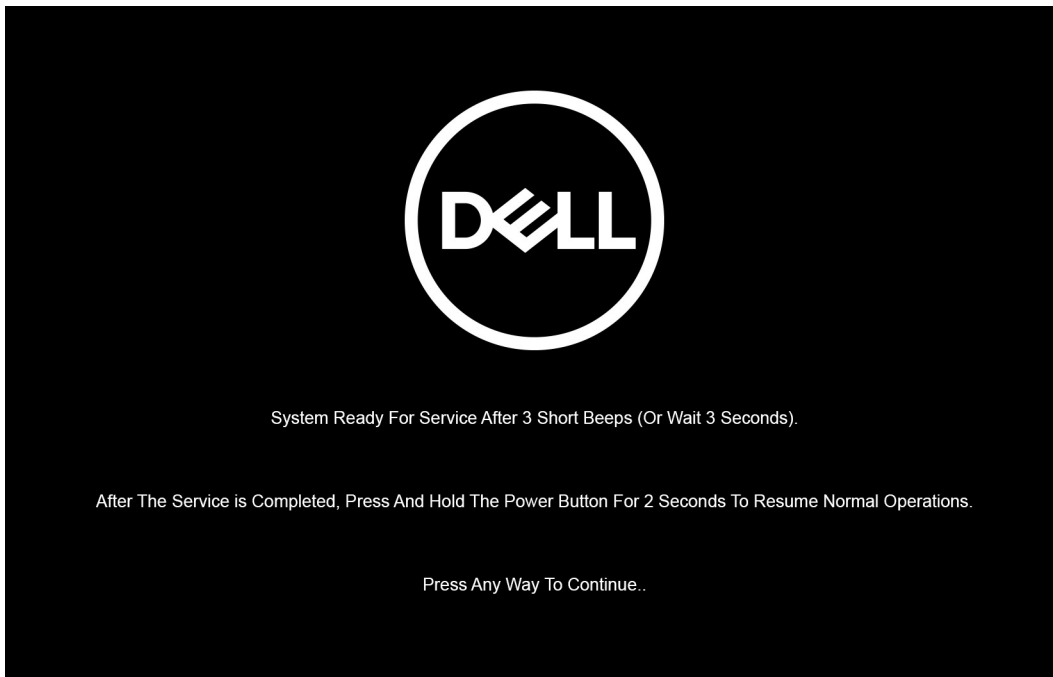

NOTE: If the AC adapter has not been disconnected, a message prompting you to remove the AC adapter appears on the screen. Remove the AC adapter and then press any key to continue the **Service Mode** procedure.

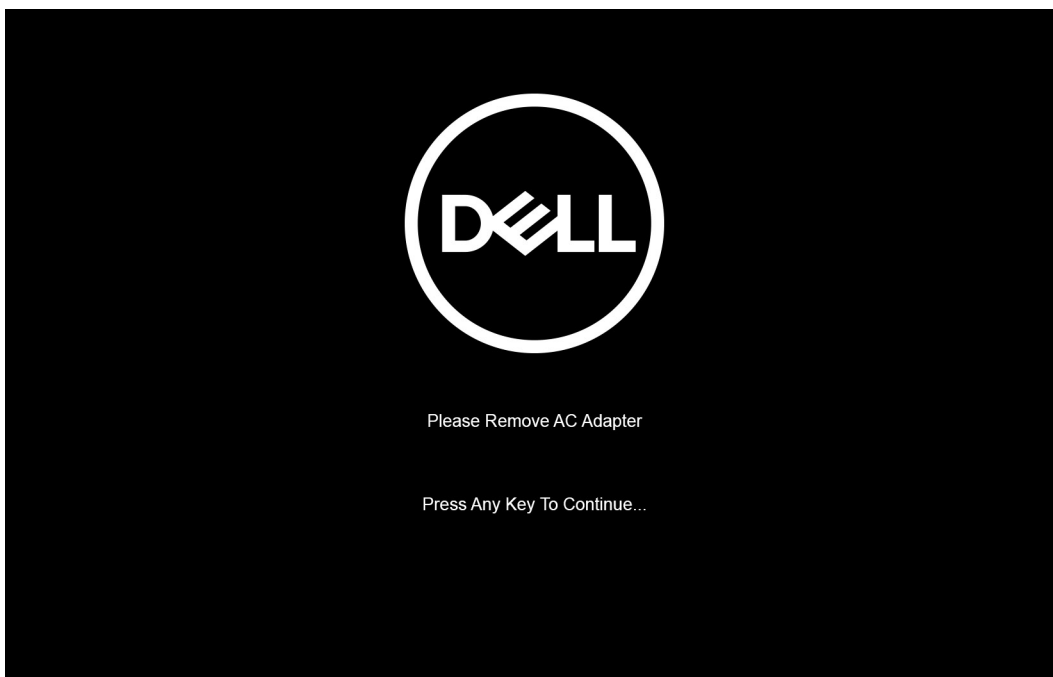

Once the system shuts down, you can perform the replacement procedures without disconnecting the battery cable from the system board.

5. To exit **Service Mode** after finishing replacement procedures, connect AC adapter and press the power button to power on the system. The system automatically returns to normal functioning mode.

After working inside your computer

About this task

CAUTION: Leaving stray or loose screws inside your computer may severely damage your computer.

Steps

1. Replace all screws and ensure that no stray screws remain inside your computer.
2. Connect any external devices, peripherals, or cables you removed before working on your computer.
3. Replace any media cards, discs, or any other parts that you removed before working on your computer.
4. Connect your computer and all attached devices to their electrical outlets.
5. Turn on your computer.

Removing and installing components

NOTE: The images in this document may differ from your computer depending on the configuration you ordered.

Topics:

- Recommended tools
- Screw list
- Major components of your system
- SIM card tray
- MicroSD card
- Base cover
- Battery
- Battery cable
- WLAN card
- WWAN card
- Solid-state drive
- Speakers
- Fan
- Heat sink
- System board
- Power button with fingerprint reader (optional)
- Display assembly
- Display bezel
- Display panel
- Display hinges
- Display back cover assembly
- eDP cable
- Sensor board
- LED board
- Camera
- Smart card reader
- Keyboard
- SIM card slot filler
- Palm-rest and keyboard assembly

Recommended tools

The procedures in this document may require the following tools:

- Phillips #0 screwdriver
- Plastic scribe

NOTE: The #0 screw driver is for screws 0-1, and the #1 screw driver is for screws 2-4.

Screw list

NOTE: When removing screws from a component, it is recommended to note the screw type, the quantity of screws, and then place them in a screw storage box. This is to ensure that the correct number of screws and correct screw type is restored when the component is replaced.

NOTE: Some computers have magnetic surfaces. Ensure that the screws are not left attached to such surface when replacing a component.

NOTE: Screw color may vary with the configuration ordered.

Table 1. Screw list



















Component	Screw type	Quantity	Screw image
Base cover	Captive screws	8	
3-cell battery	Captive screws	4	
4-cell battery	Captive screws	4	
WLAN	M2x3	1	
WWAN	M2x3	1	
Solid-state drive bracket	M2x2.5	2	
Fan	M2x3	2	
Heat sink - UMA only	Captive screws	4	
System board	M2x3 M2x4 M2x2.5	2 1 2	  
Type-C bracket	M2x5	3	
Power button with fingerprint reader	M2x2.5	1	
Fingerprint reader bracket Note: Systems with non-fingerprint reader configuration do not have a fingerprint reader bracket.	M2x4	1	
Keyboard	M2x2	19	
Display assembly	Laptop - M2.5x4 2-in-1 - M2.5x4	4 4	 
Display panel	Laptop - M2x2.5	2	
Hinge screws	M2.5x3	6	

Table 1. Screw list (continued)

Component	Screw type	Quantity	Screw image
eDP (or display) cable bracket	M2x4	1	
LED board	M2x3	1	
Smart card reader (optional)	M2x2.5	2	

Major components of your system

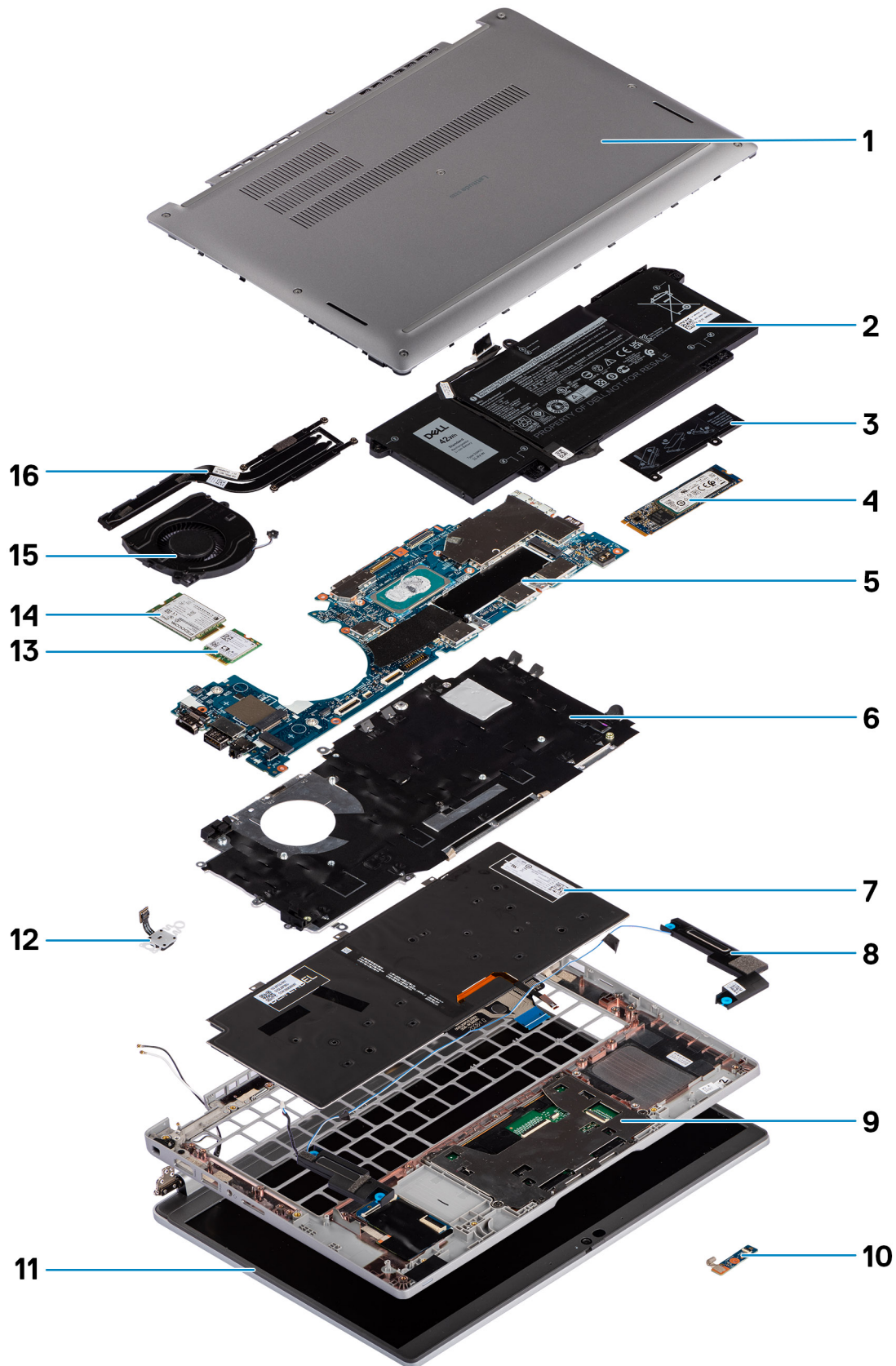

1. Base cover

2. Battery
3. SSD thermal plate
4. M.2 2280 SSD card
5. System board
6. Keyboard bracket
7. Keyboard
8. Speakers
9. Palm-rest assembly
10. LED board
11. Display panel
12. Power button with fingerprint reader (optional)
13. WLAN
14. WWAN
15. Fan
16. Heat sink

i **NOTE:** Dell provides a list of components and their part numbers for the original system configuration purchased. These parts are available according to warranty coverages purchased by the customer. Contact your Dell sales representative for purchase options.

SIM card tray

Removing the SIM card tray

Prerequisites

Follow the procedure in [before working inside your computer](#).

About this task

The following image provides a visual representation of the SIM card tray removal procedure.

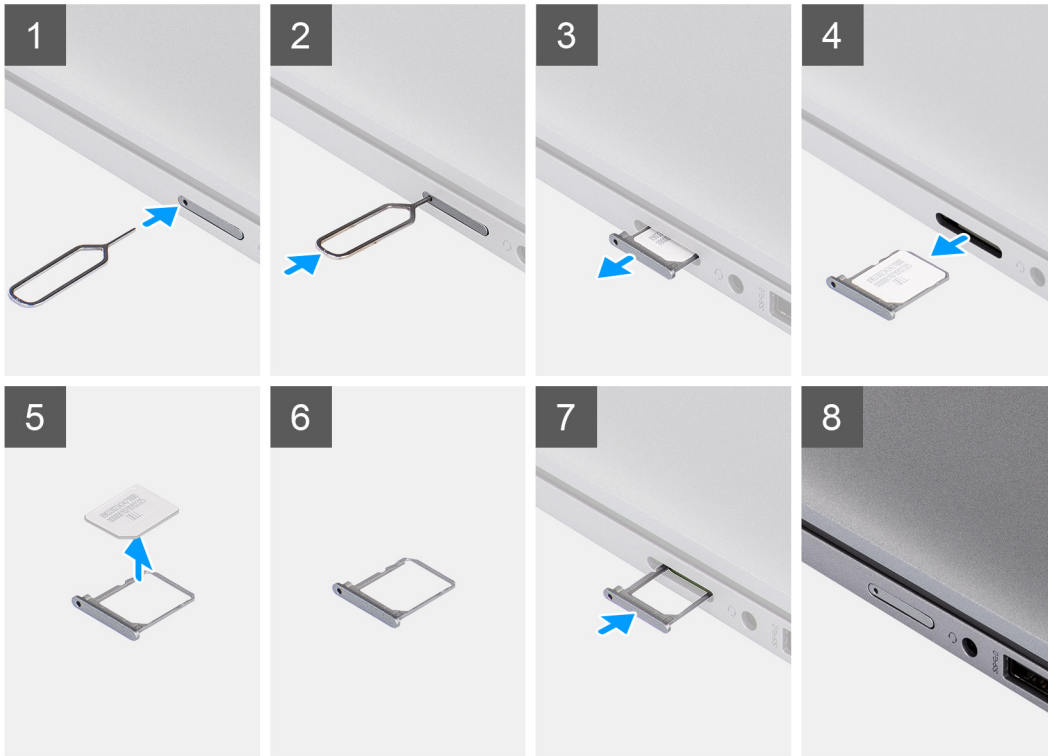

Steps

1. Insert a pin into the release hole to release the SIM card tray.
2. Push the pin to disengage the lock, and eject the SIM card tray.
3. Slide the SIM card tray out of the slot on the system.
4. Remove the SIM card from the SIM card tray.
5. Slide and push the SIM card tray back into the slot.

Installing the SIM card tray

Prerequisites

If you are replacing a component, remove the necessary component before the installation procedure.

About this task

The following image provides a visual representation of the SIM card tray installation procedure.



Steps

1. Align and place the SIM card in the dedicated slot on the SIM card tray.
2. Slide the SIM card tray into the slot in the system [6], and push it to lock in place.

Next steps

Follow the procedure in [After working on your computer](#).

MicroSD card

Removing the micro-SD card

Prerequisites

Follow the procedure in [before working inside your computer](#).

About this task

The following image provides a visual representation of the micro-SD card removal procedure.



Steps

1. Push the micro-SD card to eject it from the system.
2. Remove the micro-SD card from the system.

Installing the micro-SD card

Prerequisites

If you are replacing a component, remove the existing component before performing the installation procedure.

About this task

The following image provides a visual representation of the micro-SD card installation procedure.



Steps

Insert the micro-SD card into its slot until it clicks into place.

Next steps

1. Follow the procedure in [After working on your computer](#).

Base cover

Removing the base cover

Prerequisites

1. Follow the procedure in [before working inside your computer](#).

About this task

The following images indicate the location of the base cover and provide a visual representation of the removal procedure.



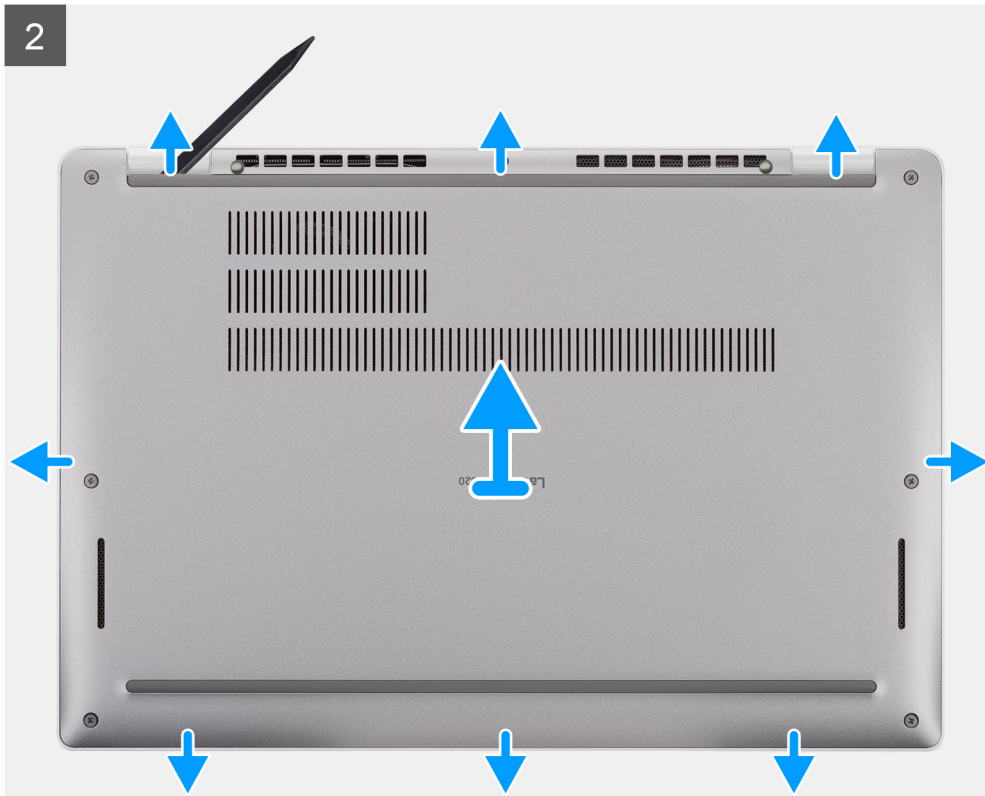

Steps

1. Loosen the eight captive screws that secure the base cover to the palm-rest assembly.
2. Using a plastic scribe, pry the base cover from the U-shaped indents at the top edge of the base cover and continue to work on the sides to release the base cover from the palm-rest assembly.
3. Lift the base cover off the palm-rest assembly.

Installing the base cover

Prerequisites

If you are replacing a component, remove the existing component before performing the installation procedure.

About this task

The following images indicate the location of the base cover and provide a visual representation of the installation procedure.

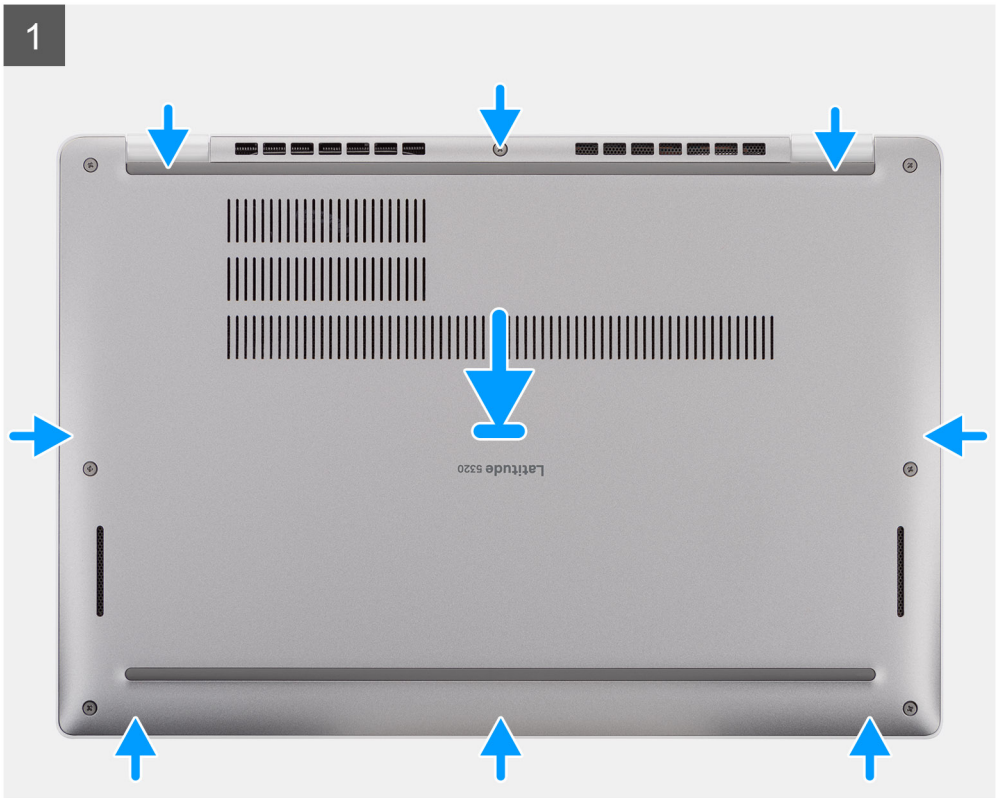

Steps

1. Align the tabs on the base cover with the slots on the system and snap the base cover to the palm-rest assembly.
2. Tighten the eight captive screws to secure the base cover to the palm-rest assembly.

Next steps

1. Follow the procedure in [after working inside your computer](#).

Battery

Lithium-ion battery precautions

CAUTION:

- Exercise caution when handling Lithium-ion batteries.
- Discharge the battery completely before removing it. Disconnect the AC power adapter from the system and operate the computer solely on battery power—the battery is fully discharged when the computer no longer turns on when the power button is pressed.
- Do not crush, drop, mutilate, or penetrate the battery with foreign objects.
- Do not expose the battery to high temperatures, or disassemble battery packs and cells.
- Do not apply pressure to the surface of the battery.
- Do not bend the battery.
- Do not use tools of any kind to pry on or against the battery.
- Ensure any screws during the servicing of this product are not lost or misplaced, to prevent accidental puncture or damage to the battery and other system components.
- If the battery gets stuck inside your computer as a result of swelling, do not try to release it as puncturing, bending, or crushing a lithium-ion battery can be dangerous. In such an instance, contact Dell technical support for assistance. See www.dell.com/contactdell.
- Always purchase genuine batteries from www.dell.com or authorized Dell partners and resellers.
- Swollen batteries should not be used and should be replaced and disposed properly. For guidelines on how to handle and replace swollen Lithium-ion batteries, see [Handling swollen Lithium-ion batteries](#).

Removing the battery

Prerequisites

1. Follow the procedure in [before working inside your computer](#).
2. Remove the [base cover](#).

About this task

 **NOTE:** Latitude 5320 supports 3-cell 42 WHr and 4-cell 63 WHr battery configuration.

The following image indicates the location of the 3-cell 42 WHr battery and provides a visual representation of the removal procedure.



4x

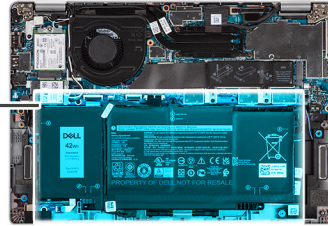
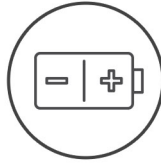

Steps

1. Disconnect the battery cable from its connector on the system board.
2. Loosen the four captive screws that secure the battery to the palm-rest assembly.
3. Lift the battery off the palm-rest assembly.

Installing the battery

Prerequisites

If you are replacing a component, remove the existing component before performing the installation procedure.

About this task

NOTE: Latitude 5320 supports 3-cell 42 WHr and 4-cell 63 WHr battery configuration.

The following image indicates the location of the 3-cell 42 WHr battery and provides a visual representation of the installation procedure.



4x

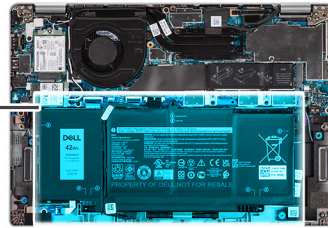
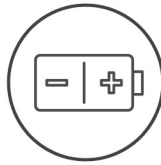

Steps

1. Place the battery on the palm-rest and keyboard assembly and align the screw holes on the battery with the screw holes on the palm-rest and keyboard assembly.
2. Tighten the four captive screws to secure the battery in place.
3. Connect the battery cable to the system board.

Next steps

1. Install the [base cover](#).
2. Follow the procedure in [After working on your computer](#).

Battery cable

Removing the battery cable

Prerequisites

1. Follow the procedure in [before working inside your computer](#).
2. Remove the [base cover](#).
3. Remove the [battery](#).

NOTE: If battery is disconnected from system board for service, then there is a delay during system boot as the system undergoes RTC battery reset.

About this task

The following images indicate the location of the battery cable and provide a visual representation of the removal procedure.

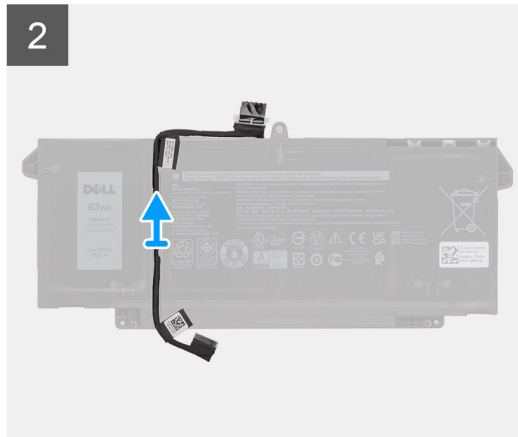
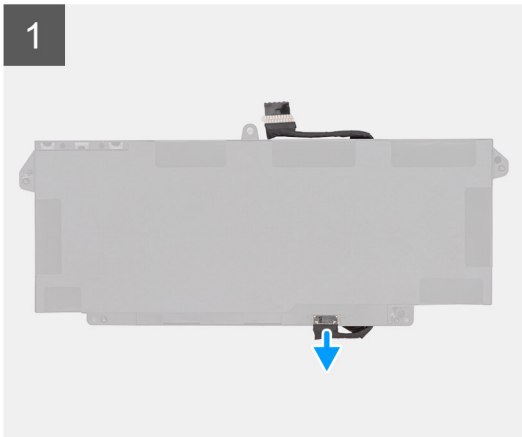

Steps

1. Flip the battery and unrout the battery cable from the routing guides on the battery.
2. Disconnect the battery cable from the connector on the battery.
3. Lift the battery cable away from the battery.

Installing the battery cable

Prerequisites

If you are replacing a component, remove the existing component before performing the installation procedure.

About this task

The following image indicates the location of the battery cable and provides a visual representation of the installation procedure.

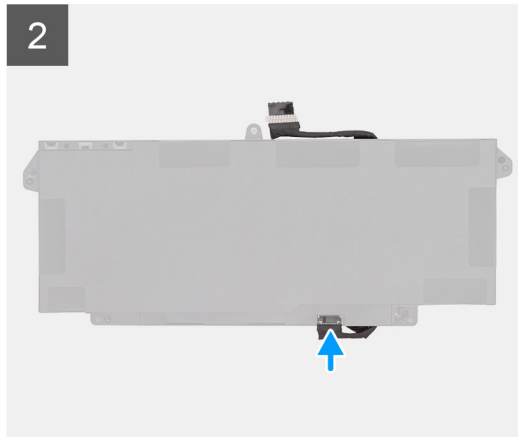
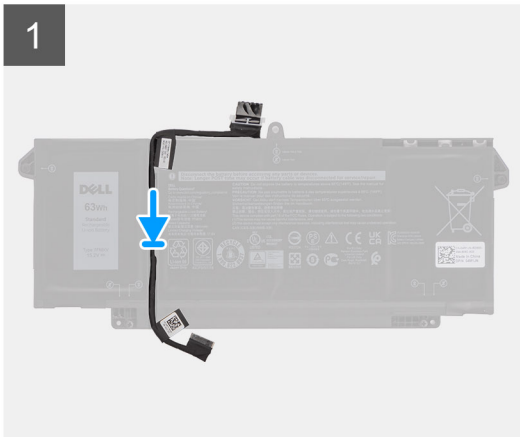

Steps

1. Align and place the battery cable on the battery.
2. Route the battery cable through the routing guides on the battery.
3. Connect the battery cable to the connector on the battery.

Next steps

1. Install the [battery](#).
2. Install the [base cover](#).
3. Follow the procedure in [After working on your computer](#) .

WLAN card

Removing the WLAN card

Prerequisites

1. Follow the procedure in [before working inside your computer](#).
2. Remove the [base cover](#).
3. Enter [service mode](#).

About this task

The following images indicate the location of the WLAN card and provide a visual representation of the removal procedure.



1x
M2x3

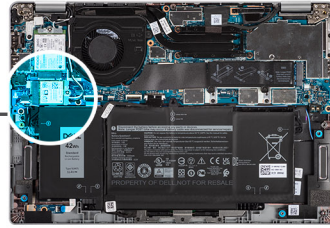

Steps

1. Remove the single screw (M2x3) that secures the WLAN card bracket to the WLAN card.
2. Remove the WLAN card bracket from the WLAN card.
3. Disconnect the antenna cables from the WLAN card.
4. Slide and remove the WLAN card from the WLAN card slot.

i **NOTE:** When removing the WLAN card from the system, if the adhesive pad which helps secure the WLAN card in place is removed from the system along with the WLAN card, adhere it back to the system.

Installing the WLAN card

Prerequisites

If you are replacing a component, remove the existing component before performing the installation procedure.

About this task

The following image indicates the location of the WLAN card and provides a visual representation of the installation procedure.



1x
M2x3

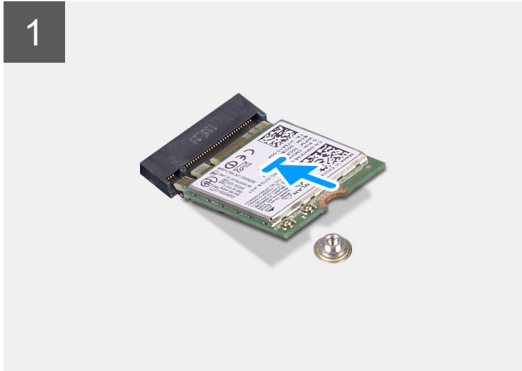
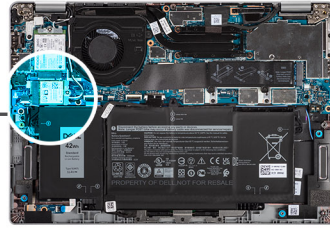

Steps

1. Align the notch on the WLAN card with the tab on the WLAN card slot and insert the WLAN card at an angle into the WLAN card slot.
2. Connect the antenna cables to the WLAN card.
3. Align and place the WLAN card bracket on the WLAN card.
4. Replace the screw (M2x3) to secure the WLAN card bracket to the WLAN card.

Next steps

1. Install the [base cover](#).
2. Connect the AC adapter and power on the system.
3. Follow the procedure in [after working inside your computer](#).

WWAN card

Removing the WWAN card

Prerequisites

1. Follow the procedure in [before working inside your computer](#).
2. Remove the [base cover](#).
3. Enter [service mode](#).

About this task

The following images indicate the location of the WWAN card and provide a visual representation of the removal procedure.

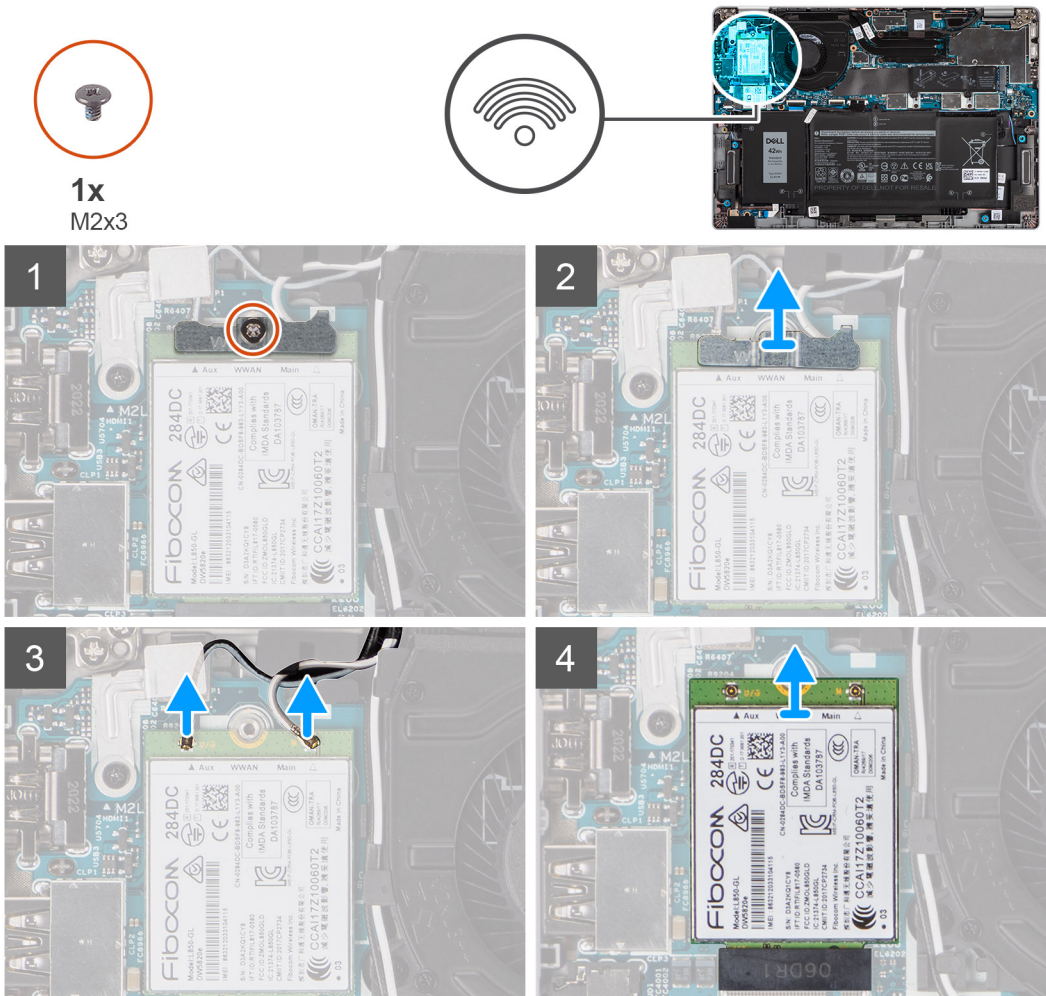

Steps

1. Remove the single screw (M2x3) that secures the WWAN card bracket to the WWAN card.
2. Lift the WWAN-card bracket out of the system.
3. Disconnect the antenna cables from the connectors on the WWAN card.
4. Slide and remove the WWAN card from the WWAN card slot.

Installing the WWAN card

Prerequisites

If you are replacing a component, remove the existing component before performing the installation procedure.

About this task

The following image indicates the location of the WWAN card and provides a visual representation of the installation procedure.



1x
M2x3

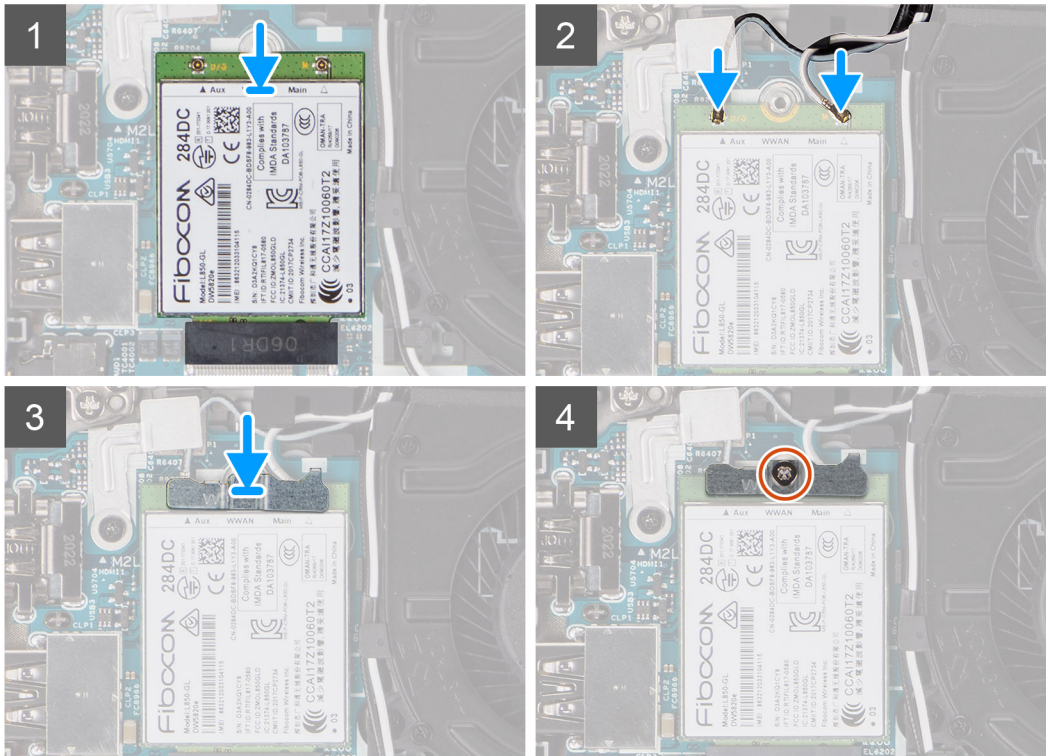
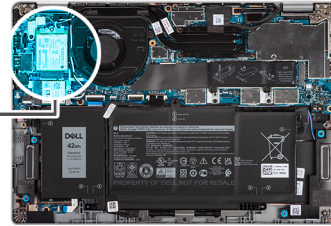

NOTE: For instructions on how to find your computer's IMEI (International Mobile Station Equipment Identity) number, see the knowledge base article [000143678](http://www.dell.com/support) at www.dell.com/support.

Steps

1. Align the notch on the WWAN card and slide the WWAN card at an angle into the WWAN-card slot.
2. Connect the antenna cables to the connectors on the WWAN card.
3. Align and place the WWAN-card bracket on the system board and WWAN card, and tighten the single (M2x3) screw.

Next steps

1. Install the [base cover](#).
2. Connect the AC adapter and power on the system.
3. Follow the procedure in [After working on your computer](#).

Solid-state drive

Removing the M.2 2280 solid-state drive

Prerequisites

1. Follow the procedure in [before working inside your computer](#).
2. Remove the [base cover](#).
3. Enter [service mode](#).

About this task

The following images indicate the location of the solid-state drive and provide a visual representation of the removal procedure of M.2 2280 SSD.

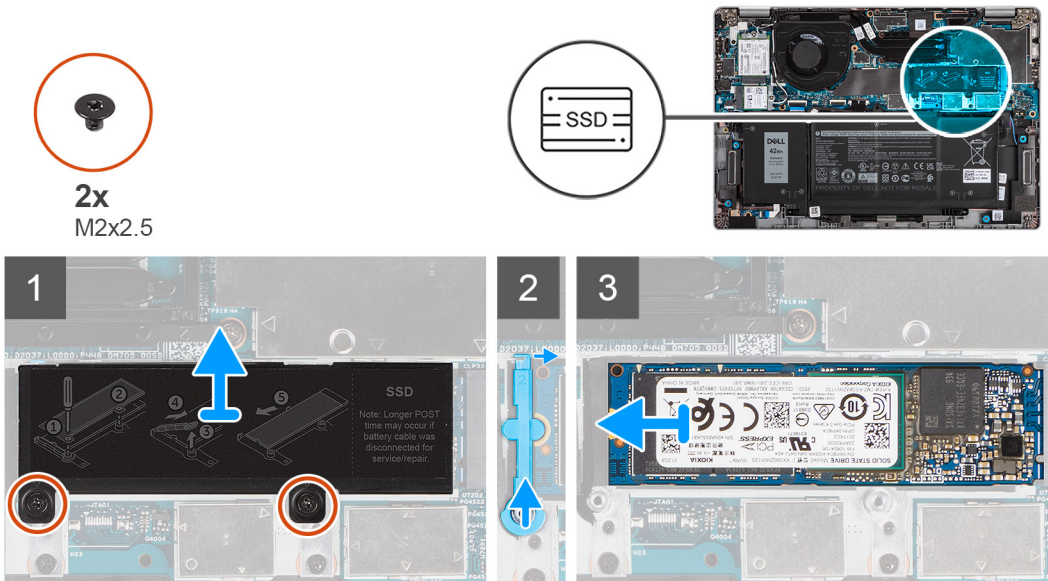

Steps

1. Remove the two screws (M2x2.5) that secure the solid-state drive thermal plate to the system board.
2. Lift the solid-state drive thermal plate away from the system.
3. Lift the securing rod and carefully release it from the hook to remove it.
4. Slide and remove the solid-state drive from the solid-state drive slot on the system board.

Installing the M.2 2280 solid-state drive

Prerequisites

If you are replacing a component, remove the existing component before performing the installation procedure.

About this task

The following image indicates the location of the solid-state drive and provides a visual representation of the installation procedure of M.2 2280 SSD.

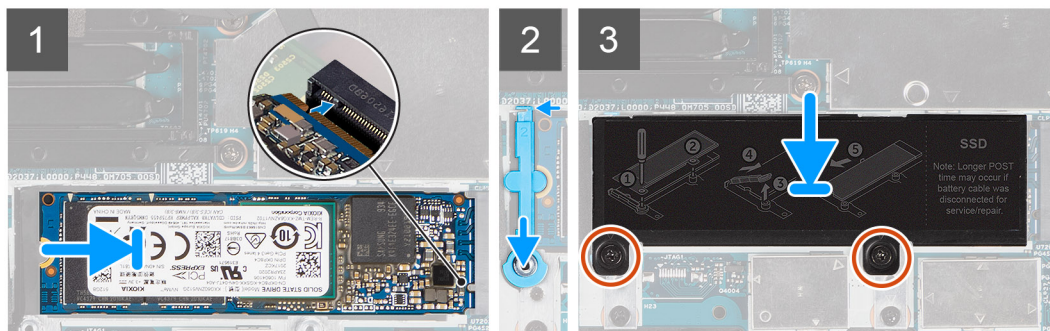
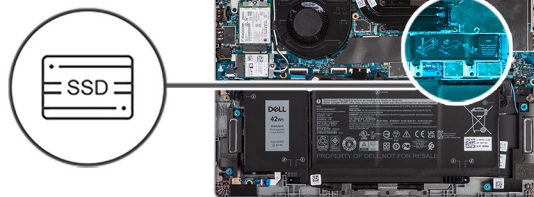

Steps

1. Align the notch on the solid-state drive with the tab on the M.2 card slot.
2. Slide the solid-state drive into the M.2 card slot on the system board.
3. Slide the securing rod over the hook and press it down.
4. Align and place the solid-state drive thermal plate and press to fit it firmly to cover the solid-state drive.
5. Replace the two screws (M2x2.5) that secure the solid-state drive thermal plate to the system board.

Next steps

1. Install the [base cover](#).
2. Connect the AC adapter and power on the system.
3. Follow the procedure in [After working on your computer](#).

Removing the M.2 2230 solid-state drive

Prerequisites

1. Follow the procedure in [before working inside your computer](#).
2. Remove the [base cover](#).
3. Enter [service mode](#).

About this task

The following images indicate the location of the solid-state drive and provide a visual representation of the removal procedure of M.2 2230 SSD.



2x
M2x2.5

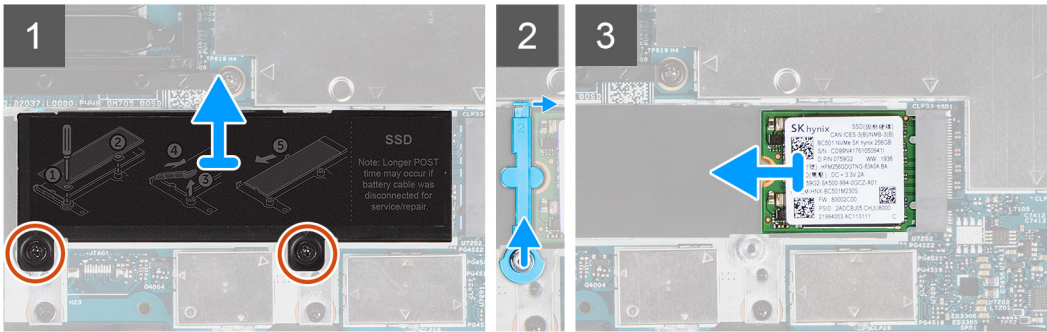
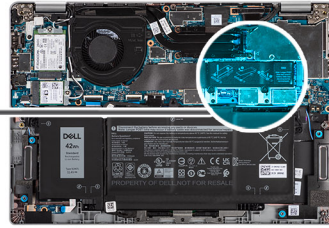

Steps

1. Remove the two screws (M2x2.5) that secure the solid-state drive thermal plate to the system board.
2. Lift the solid-state drive thermal plate away from the system.
3. Lift the securing rod and carefully release it from the hook to remove it.
4. Slide and remove the solid-state drive from the solid-state drive slot on the system board.

Installing the M.2 2230 solid-state drive

Prerequisites

If you are replacing a component, remove the existing component before performing the installation procedure.

About this task

The following image indicates the location of the solid-state drive and provides a visual representation of the installation procedure of M.2 2230 SSD.



2x
M2x2.5

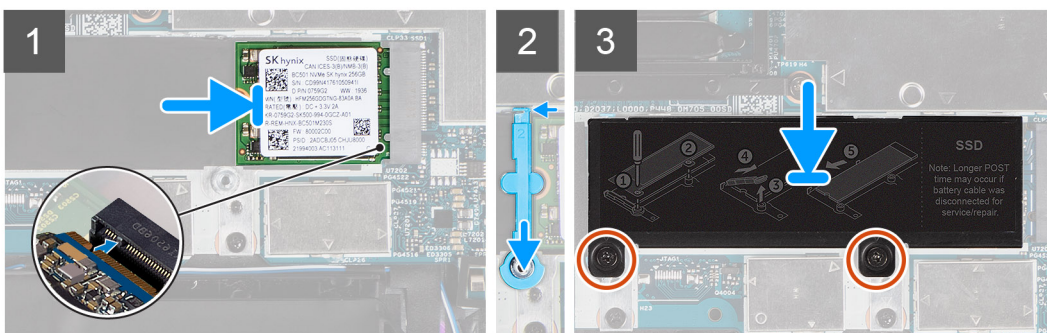
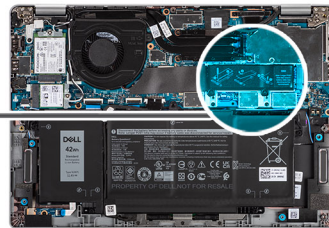

Steps

1. Align the notch on the solid-state drive with the tab on the M.2 card slot.
2. Slide the solid-state drive into the M.2 card slot on the system board.
3. Slide the securing rod over the hook and press it down.
4. Align and place the solid-state thermal plate and press to fit it firmly to cover the solid-state drive.
5. Replace the two screws (M2x2.5) that secure the solid-state drive thermal plate to the system board.

Next steps

1. Install the [base cover](#).
2. Connect the AC adapter and power on the system.
3. Follow the procedure in [After working on your computer](#).

Replacing the SSD securing rod

Prerequisites

1. Follow the procedure in [before working inside your computer](#).
2. Remove the [base cover](#).
3. Enter [service mode](#) if SSD card has been installed and you are removing SSD card before replacing the securing rod.

About this task

The figure provides a visual representation if you are replacing a M.2 2280 solid-state drive with a M.2 2230 solid-state drive.

NOTE: Ensure the M.2 2280 solid-state drive is removed first. See the procedure for removing the [M.2 2280 solid-state drive](#).

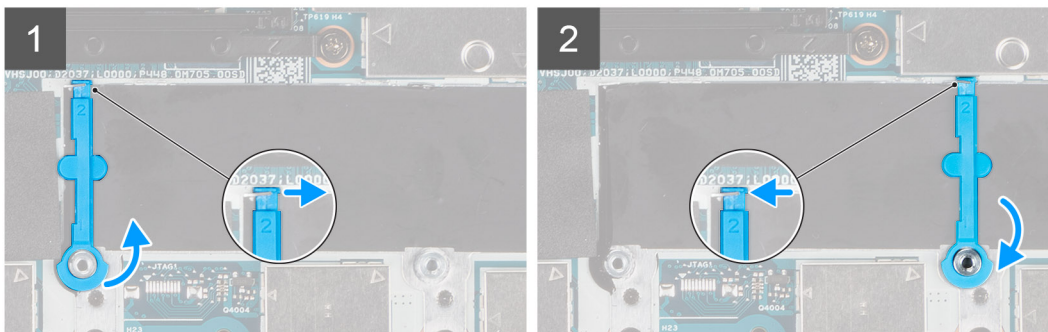
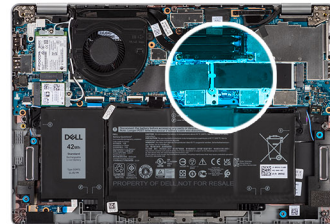

The figure provides a visual representation if you are replacing a M.2 2230 solid-state drive with a M.2 2280 solid-state drive.

NOTE: Ensure the M.2 2230 solid-state drive is removed first. See the procedure for removing the [M.2 2230 solid-state drive](#).

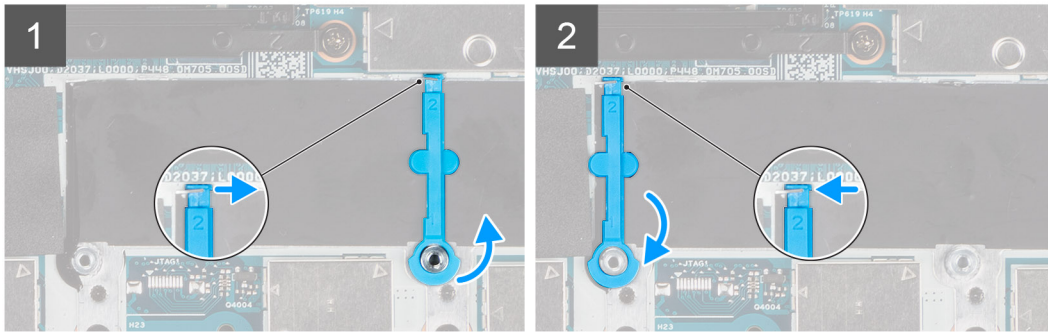
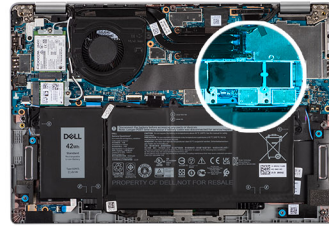

Steps

1. Lift and slide the SSD securing rod over the hook to remove it.
2. Depending on the type of solid-state drive (M.2 2230/ M.2 2280), align and insert the SSD extender.
3. Install the solid-state drive.

Speakers

Removing the speakers

Prerequisites

1. Follow the procedure in [before working inside your computer](#).
2. Remove the [base cover](#).
3. Remove the [battery](#).

About this task

The following images indicate the location of the speakers and provide a visual representation of the removal procedure.

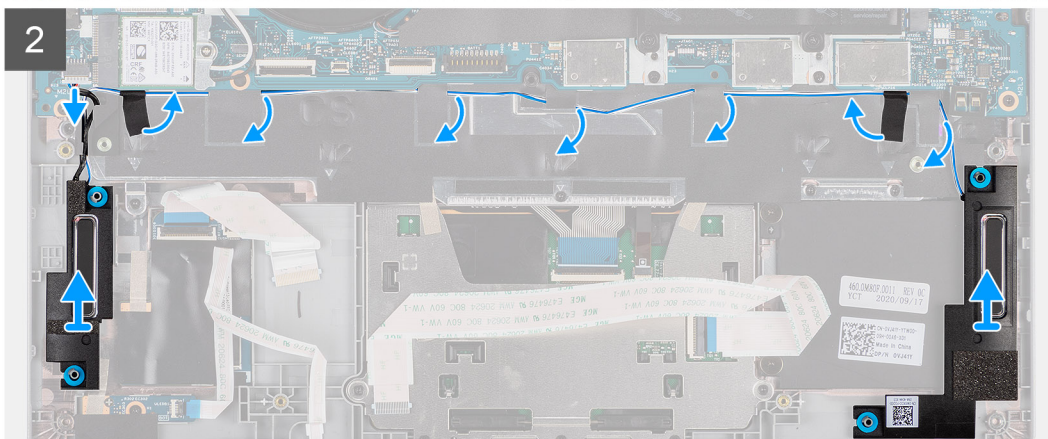
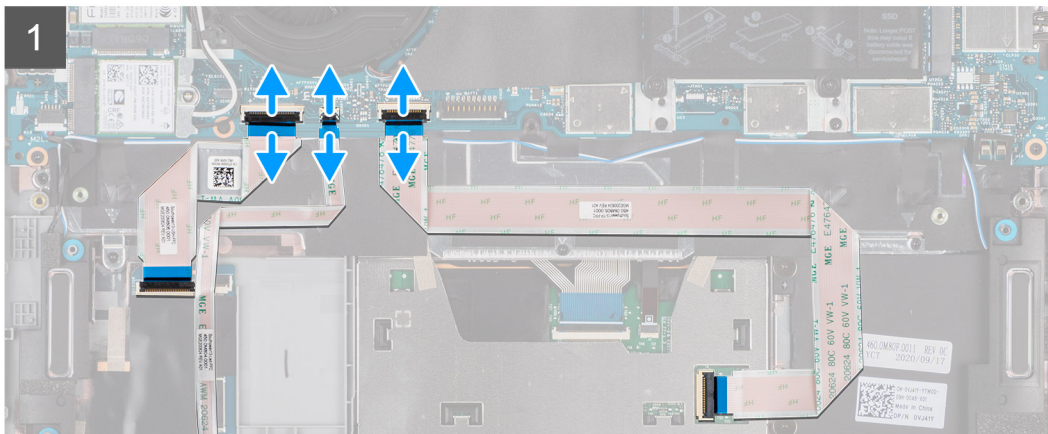
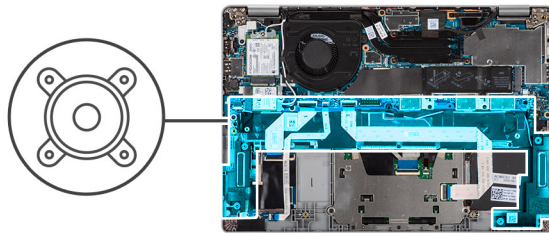

Steps

1. Disconnect the USH cable, LED cable, and the clickpad cable from their connectors on the system board.
2. Disconnect the speaker cable from the connector on the system board.
3. Peel the adhesive tape that secures the speaker cable.
4. Note the speaker cable routing, and remove the speaker cable from the routing guides on the palm-rest and keyboard assembly.
5. Lift the speakers along with the cable off the palm-rest and keyboard assembly.

Installing the speakers

Prerequisites

If you are replacing a component, remove the existing component before performing the installation procedure.

About this task

The following image indicates the location of the speaker and provides a visual representation of the installation procedure.

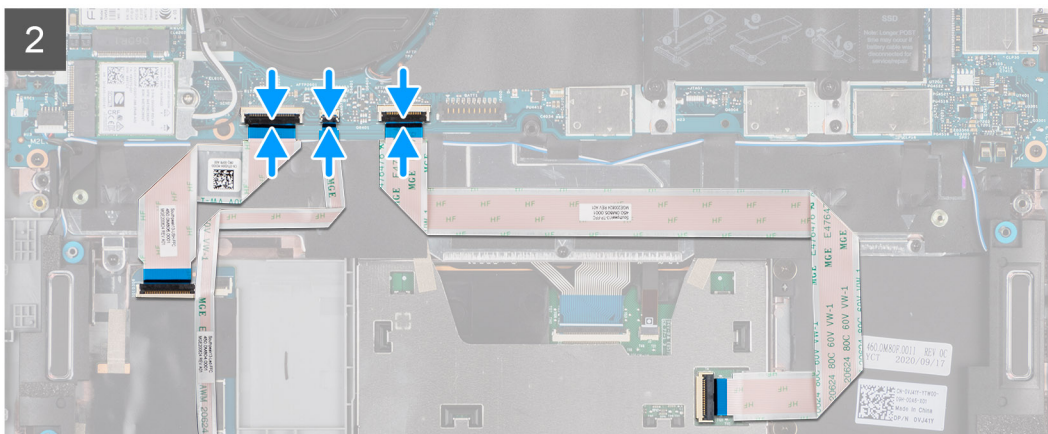
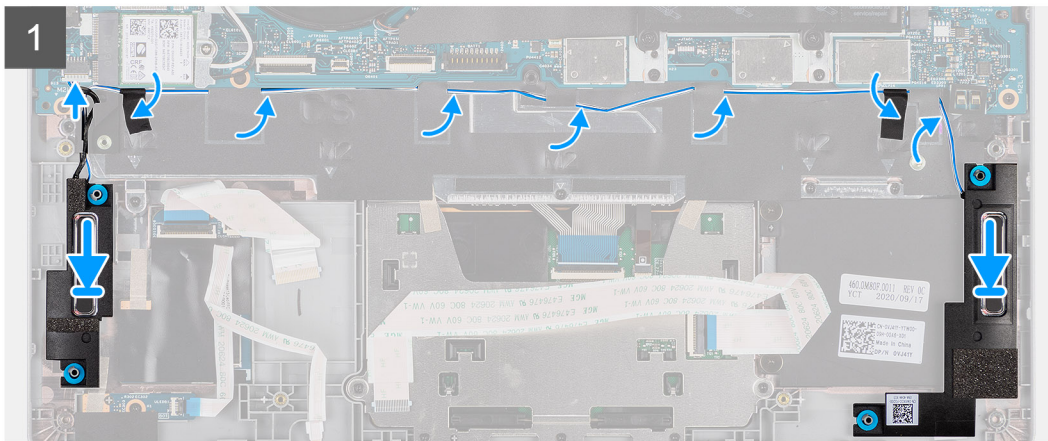
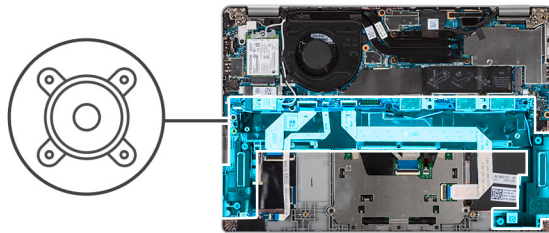

Steps

1. Using the alignment posts and rubber grommets, place the speakers in the slots on the palm-rest and keyboard assembly.
2. Route the speaker cable through the routing guides on the palm-rest and keyboard assembly.
3. Connect the speaker cable to the system board.
4. Adhere the tape back to secure the speaker cables.
5. Connect the speaker cable to its connector on the system board.
6. Connect the USH cable, LED cable, and clickpad cable to its connectors on the system board.

Next steps

1. Install the [battery](#).
2. Install the [base cover](#).
3. Follow the procedure in [after working inside your computer](#).

Fan

Removing the fan

Prerequisites

1. Follow the procedure in [before working inside your computer](#).
2. Remove the [base cover](#).
3. Remove the [battery](#).
4. Remove the [WLAN card](#).
5. Remove the [WWAN card](#) (optional).

About this task

The following images indicate the location of the fan and provide a visual representation of the removal procedure.

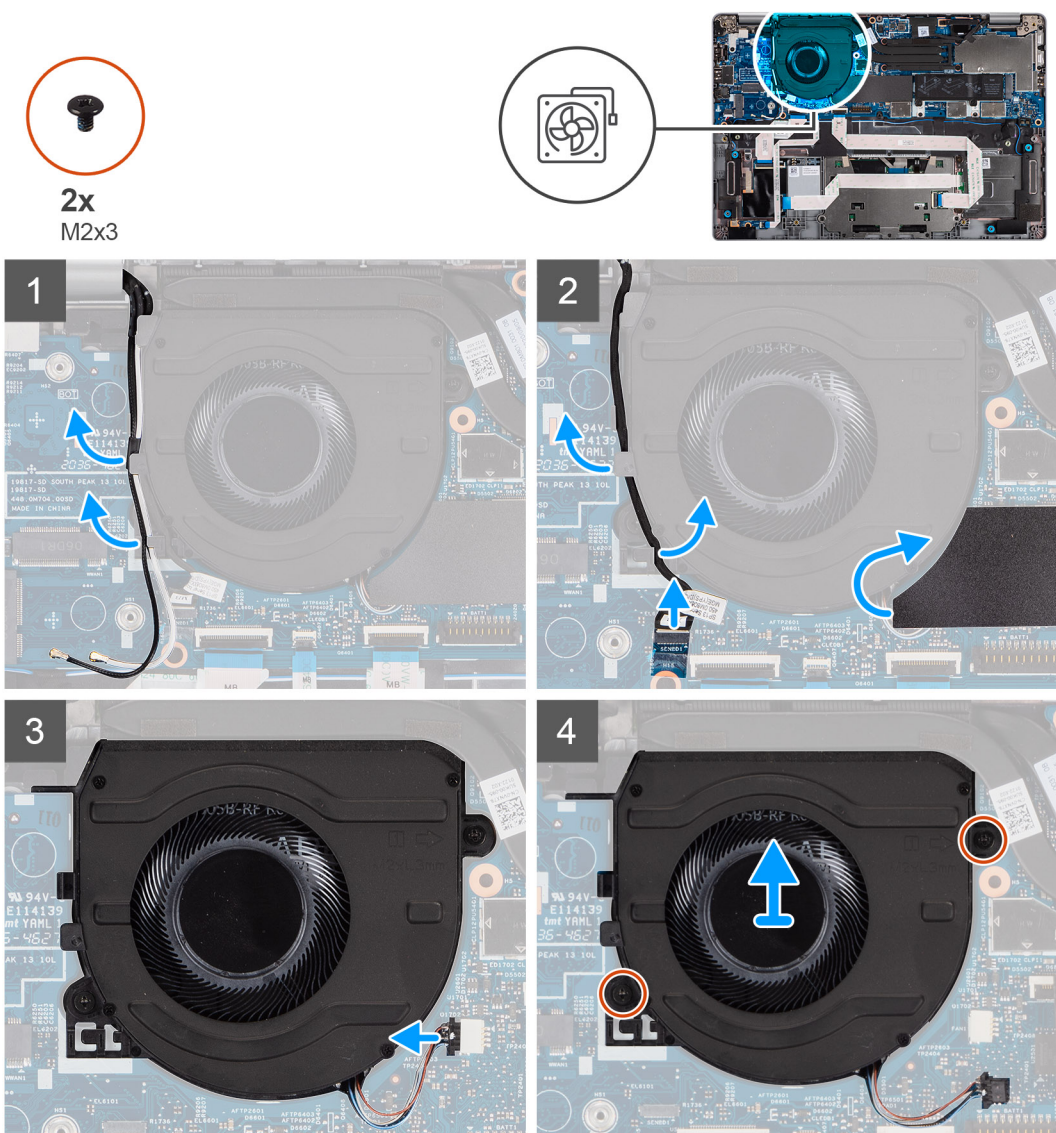

Steps

1. Note the antenna cable routing, and remove the antenna cable from the routing guides on the fan.
2. Disconnect the IR camera cable from its connector on the system board.

- Note the IR camera cable routing, and remove the IR camera cable from the routing guides on the fan.
- Lift the mylar sleeve.
- Disconnect the fan cable from its connector on the system board.
- Remove the two (M2x3) screws that secure the fan to the palm-rest and keyboard assembly.
- Lift the fan off the palm-rest and keyboard assembly.

Installing the fan

Prerequisites

If you are replacing a component, remove the existing component before performing the installation procedure.

About this task

The following image indicates the location of the fan and provides a visual representation of the installation procedure.

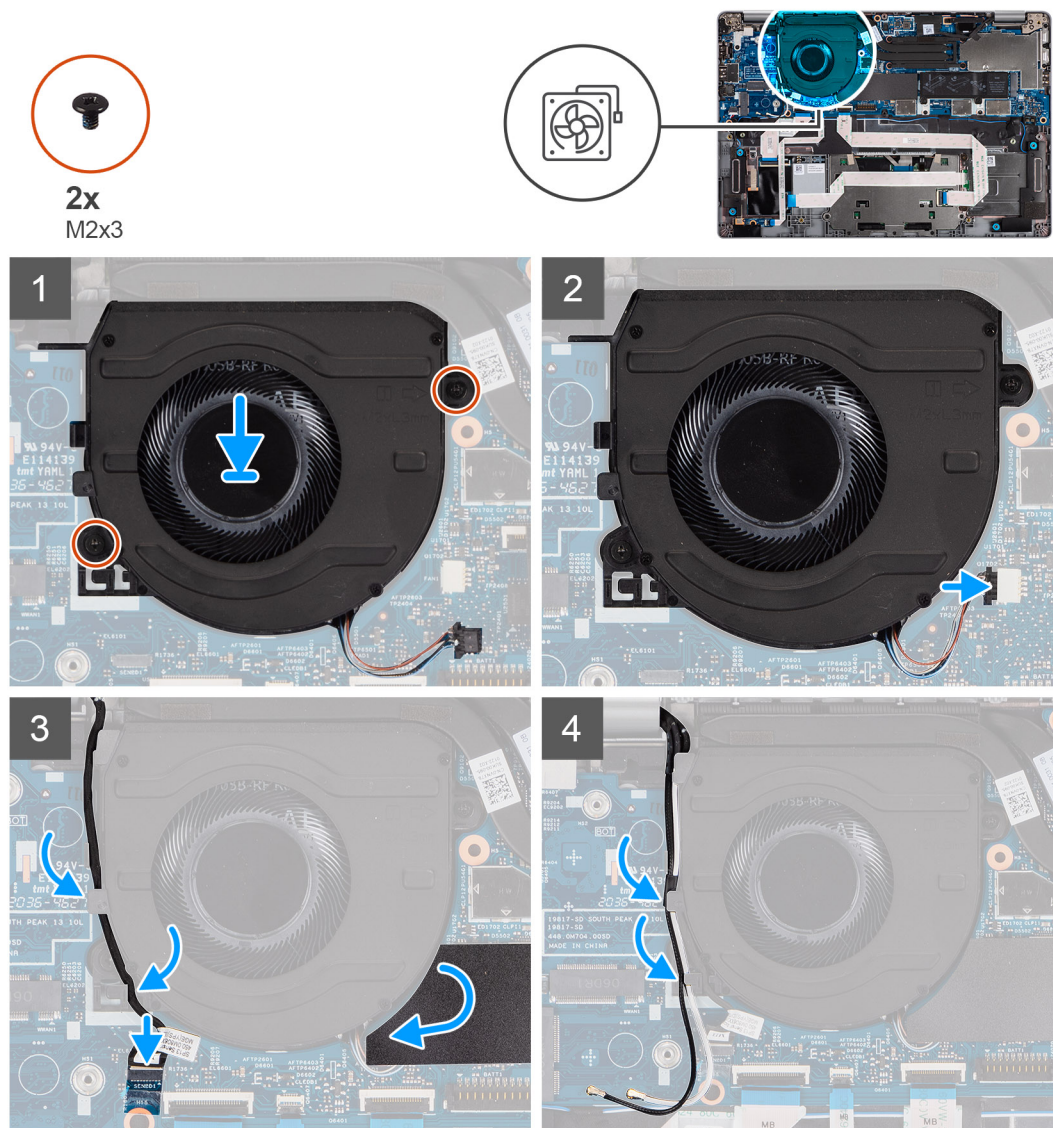

Steps

- Using the alignment posts, place the fan on the palm-rest and keyboard assembly.
- Replace the two (M2x3) screws to secure the fan to the palm-rest and keyboard assembly.
- Connect the fan cable to its connectors on the system board.

4. Route the IR camera cable underneath the fan.
5. Connect the IR camera cable to its connectors on the system board.
6. Place the mylar sleeve back.
7. Route the antenna cables back underneath the fan.

Next steps

1. Install the [WWAN card](#) (optional).
2. Install the [WLAN card](#).
3. Install the [battery](#).
4. Install the [base cover](#).
5. Follow the procedure in [after working inside your computer](#).

Heat sink

Removing the heatsink

Prerequisites

- NOTE:** The heat sink may become hot during normal operation. Allow sufficient time for the heat sink to cool before you touch it.
- NOTE:** For maximum cooling of the processor, do not touch the heat transfer areas on the heat sink. The oils in your skin can reduce the heat transfer capability of the thermal grease.

1. Follow the procedure in [before working inside your computer](#).
2. Remove the [base cover](#).
3. Remove the [battery](#).

About this task

The following images indicate the location of the heatsink and provide a visual representation of the removal procedure.

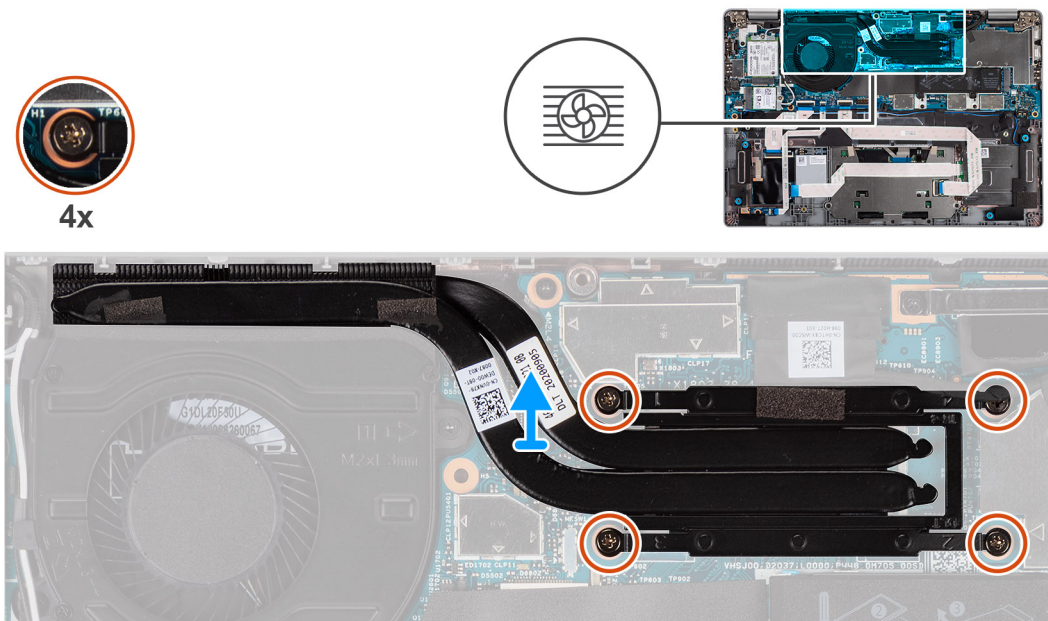

Steps

1. In reverse sequential order (as indicated on the heat sink), loosen the four captive screws that secure the heat sink to the system board.

2. Lift the heat sink off the system board.

Installing the heatsink

Prerequisites

If you are replacing a component, remove the existing component before performing the installation procedure.

- NOTE:** Incorrect alignment of the heat sink can damage the system board and processor.
- NOTE:** If either the system board or the heat sink is replaced, use the thermal pad/paste provided in the kit to ensure that thermal conductivity is achieved.

About this task

The following image indicates the location of the heatsink and provides a visual representation of the installation procedure.

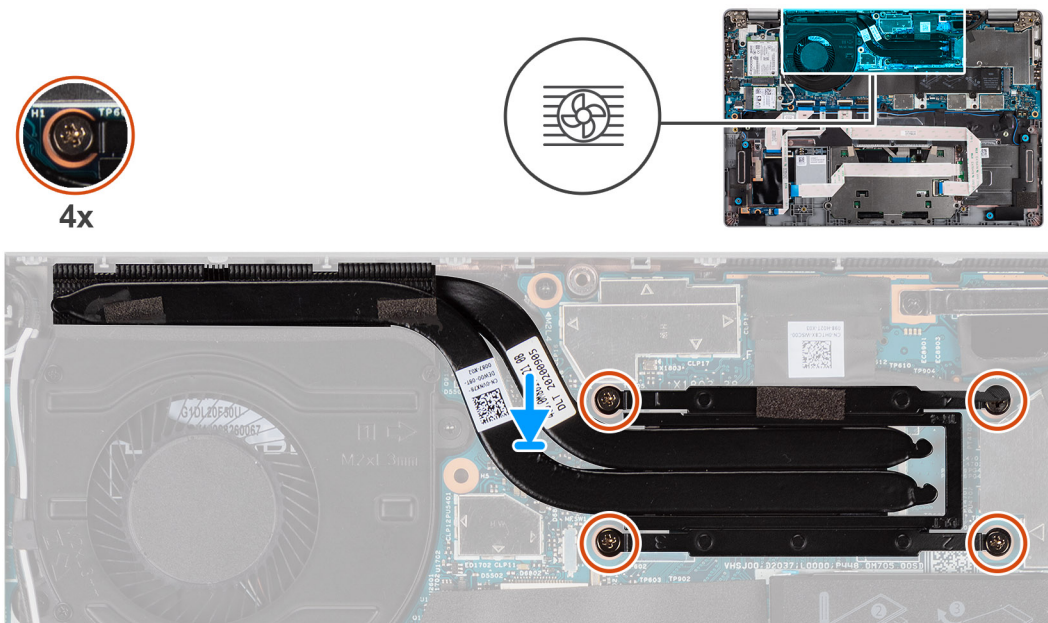

Steps

1. Align the screw holes on the heat sink with the screw holes on the system board.
2. In sequential order (as indicated on the heat sink), tighten the four captive screws that secure the heat sink to the system board.

Next steps

1. Install the [battery](#).
2. Install the [base cover](#).
3. Follow the procedure in [after working inside your computer](#).

System board

Removing the system board

Prerequisites

1. Follow the procedure in [before working inside your computer](#).
2. Remove the [microSD card](#).

3. Remove the [SIM card](#).
4. Remove the [base cover](#).
5. Remove the [battery](#).
6. Remove the [WLAN card](#).
7. Remove the [WWAN card](#) (optional).
8. Remove the [M.2 2280 SSD](#) or [M.2 2230 SSD](#).
9. Remove the [fan](#).
10. Remove the [heat sink](#).

About this task

NOTE: When removing the system board to replace/access other parts, the system board can be removed and installed with the heat sink attached in order to simplify the procedure and preserve the thermal bond between the system board and heat-sink. In order to do so, you must remove the two M2x3 screws securing the fan to the palm rest.

The following images indicate the location of the system board and provide a visual representation of the removal procedure.

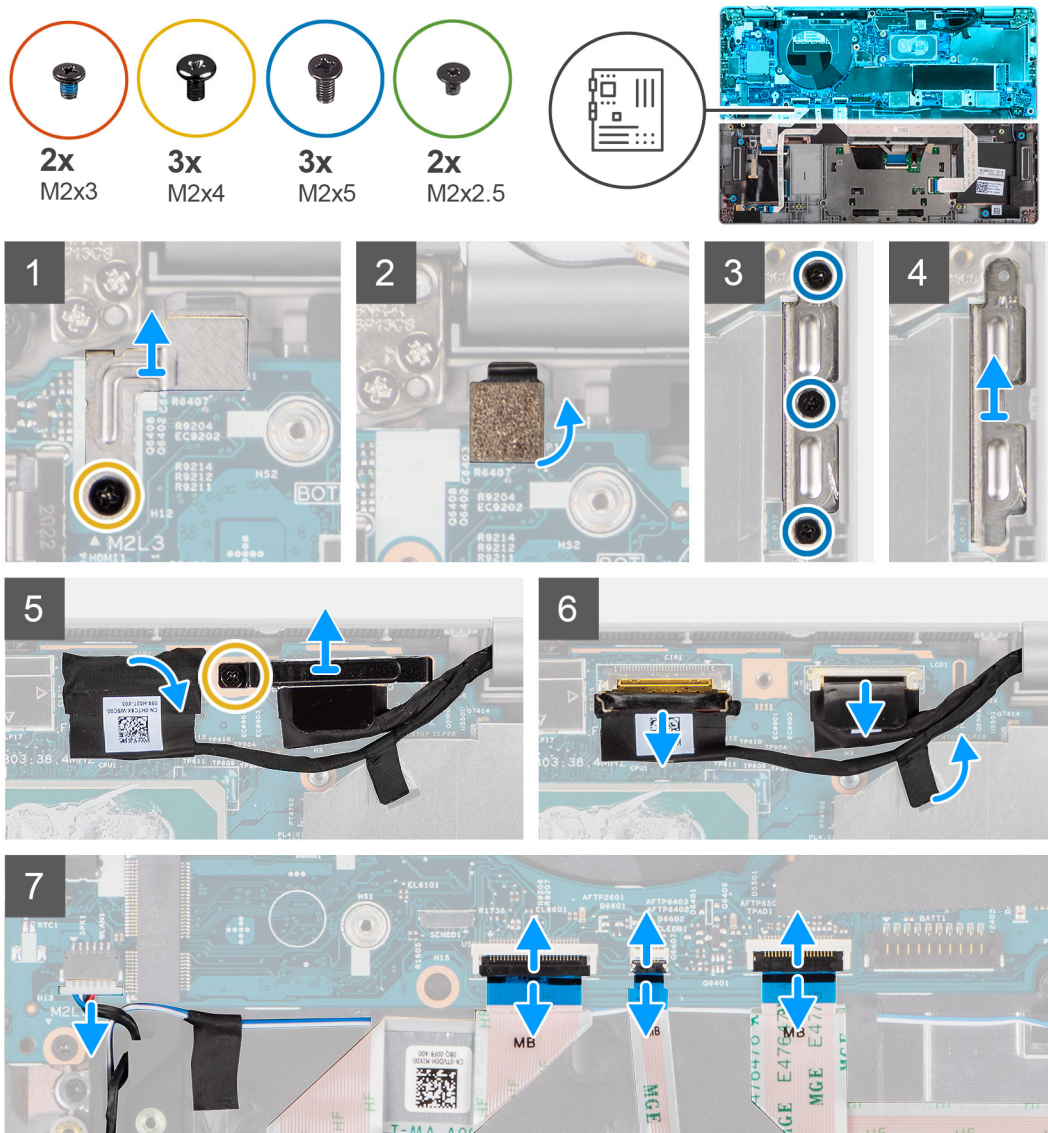

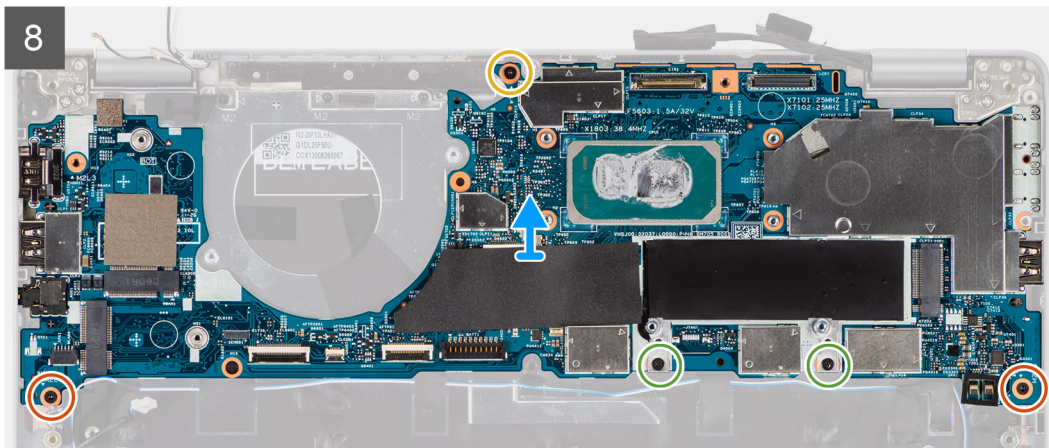

Steps

1. Remove the single (M2x4) screw that secures the fingerprint reader metal bracket.
 - NOTE:** Systems with non-fingerprint reader configuration do not have a fingerprint reader bracket.
2. Remove the fingerprint metal bracket from the system and flip the fingerprint sensor over.
3. Remove the three (M2x5) screws securing the Type-C bracket.
4. Remove the conductive tape covering the eDP cable.
5. Lift the latch and disconnect the display eDP cable its connector on the system board.
6. Remove the single (M2x4) screw that secures the display cable bracket to the system board to release the display cable.
7. Disconnect the display cable from the connector on the system board.
8. Disconnect the speaker cable from the connector on the system board.
9. Disconnect the USH cable from its connectors on the system board.
10. Disconnect the LED cable from its connectors on the system board.
11. Disconnect the clickpad cable from its connectors on the system board.
12. Remove the two (M2x3) screws, two (M2x2.5) screws, and single (M2x4) screw that secures the system board to the palm-rest and keyboard assembly.
13. Lift the system board off the palm-rest and keyboard assembly.

Installing the system board

Prerequisites

If you are replacing a component, remove the existing component before performing the installation procedure.

About this task

NOTE: When replacing/accessing other parts, the system board can be installed with the heat sink attached in order to simplify the procedure and preserve the thermal bond between the system board and heat-sink.

The following image indicates the location of the system board and provides a visual representation of the installation procedure.

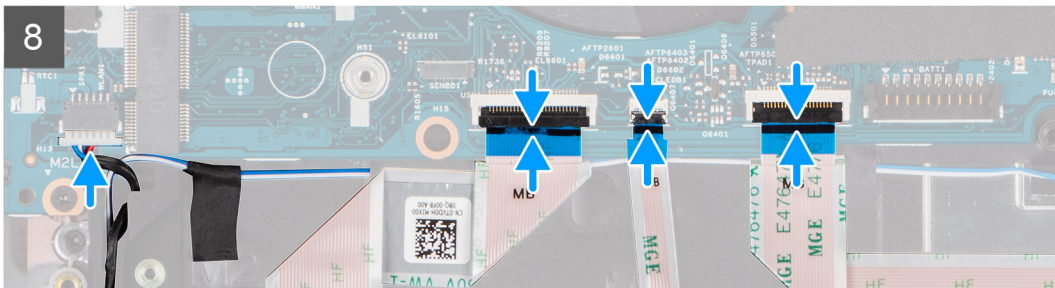
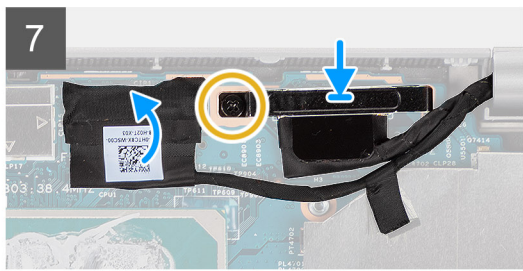
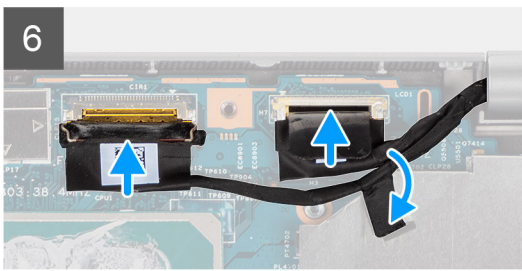
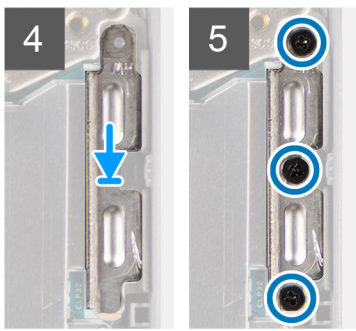
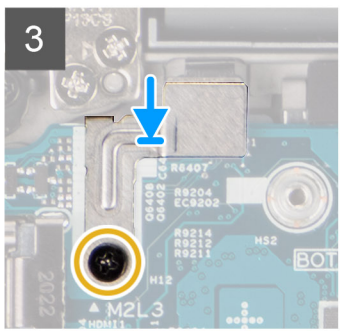
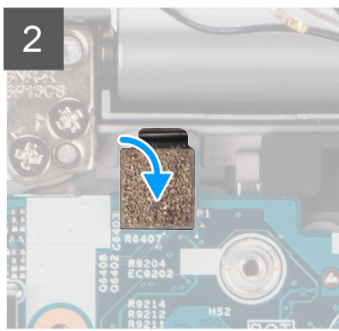
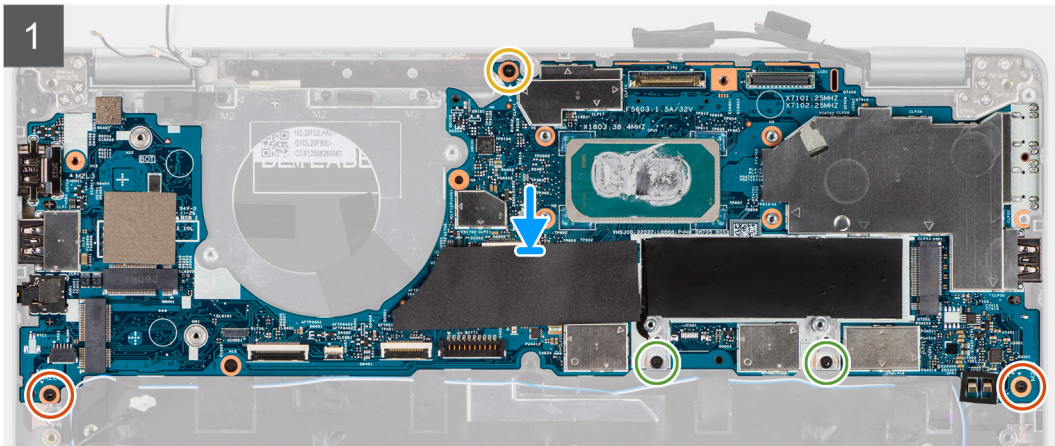
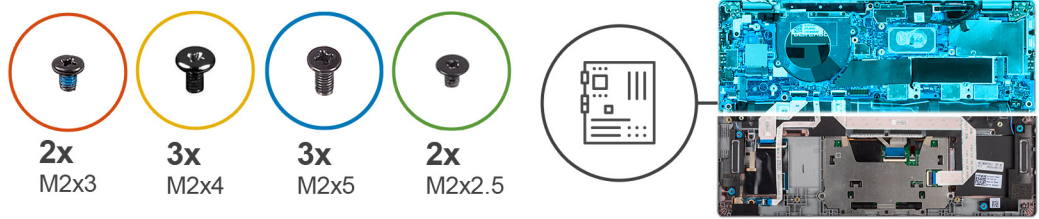

Steps

1. Place the system board on the palm-rest and keyboard assembly.
2. Replace the two (M2x3) screws, two (M2x2.5) screws, and single (M2x4) screw to secure the system board to the palm-rest and keyboard assembly.
3. Replace the fingerprint sensor.

4. Align the fingerprint reader metal bracket and replace the single (M2x4) screw it to the system board.

i **NOTE:** Systems with non-fingerprint reader configuration do not have a fingerprint reader bracket.

5. Place the type-C bracket and replace the three (M2x5) screws to secure it.
6. Connect the display eDP cable to its connector on the system board and close the latch.
7. Adhere the conductive tape to cover the eDP cable.
8. Connect the display cable to its connector on the system board.
9. Align the display cable bracket and replace the single (M2x4) screw to secure the display cable bracket to the system board.
10. Connect the speaker cable from the connector on the system board.
11. Connect the USH cable from its connectors on the system board.
12. Connect the LED cable from its connectors on the system board.
13. Connect the clickpad cable from its connectors on the system board.

Next steps

1. Install the [heat sink](#).
2. Install the [fan](#).
3. Install the [M.2 2280 SSD card](#) or [M.2 2230 SSD card](#).
4. Install the [WWAN card](#) (optional).
5. Install the [WLAN card](#).
6. Install the [battery](#).
7. Install the [base cover](#).
8. Install the [SIM card](#).
9. Install the [microSD card](#).
10. Follow the procedure in [after working inside your computer](#).

Power button with fingerprint reader (optional)

Removing the power button with fingerprint reader (optional)

Prerequisites

1. Follow the procedure in [before working inside your computer](#).
2. Remove the [base cover](#).
3. Remove the [WLAN card](#).
4. Remove the [WWAN card](#) (optional).
5. Remove the [battery](#).
6. Remove the [fan](#).
7. Remove the [heat sink](#).
8. Remove the [system board](#).

About this task

i **NOTE:** The system board can be removed with the heat sink attached in order to simplify the procedure and preserve the thermal bond between the system board and heat sink.

The following images indicate the location of the power-button board and provide a visual representation of the removal procedure.



1x
M2x2.5

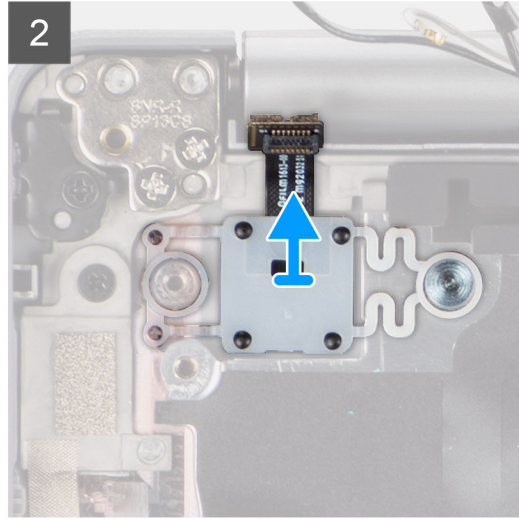
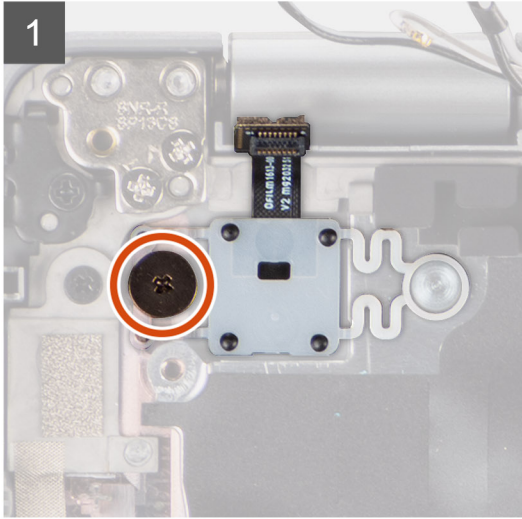
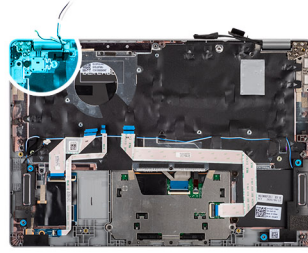

Steps

1. Remove the single (M2x2.5) screw that secures the power button to the palm-rest.
2. Lift the power button with fingerprint reader (optional) out of the system.

Installing the power button with fingerprint reader (optional)

About this task

NOTE: The system board can be installed with the heat sink attached in order to simplify the procedure and preserve the thermal bond between the system board and heat sink.

The following images indicate the location of the power button with fingerprint reader (optional) and provide a visual representation of the removal procedure.



1x
M2x2.5

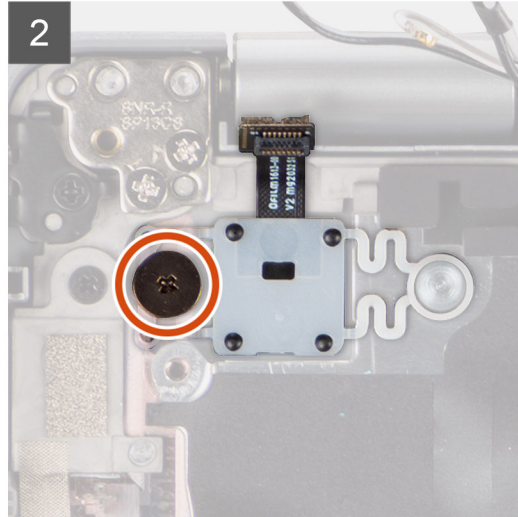
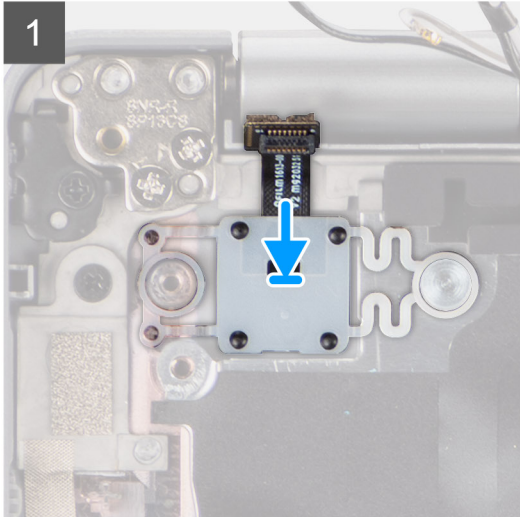
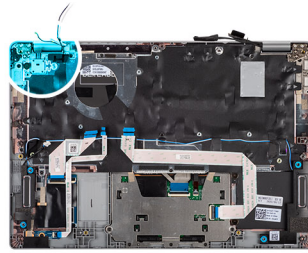

Steps

1. Align and place the power button with fingerprint reader on the palm-rest and keyboard assembly.
2. Replace the single screw (M2x2.5) to secure the power button with optional fingerprint reader to the palm-rest and keyboard assembly.

Next steps

1. Install the [system board](#).
2. Install the [heat sink](#).
3. Install the [fan](#).
4. Install the [battery](#).
5. Install the [WWAN card](#) (optional).
6. Install the [WLAN card](#).
7. Install the [base cover](#).
8. Follow the procedure in [after working inside your computer](#).

Display assembly

Removing the display assembly (laptop)

Prerequisites

1. Follow the procedure in [before working inside your computer](#).
2. Remove the [base cover](#).
3. Remove the [WLAN card](#).
4. Remove the [WWAN card](#) (optional).
5. Remove the [battery](#).

About this task

The following images indicate the location of the display assembly and provide a visual representation of the removal procedure.

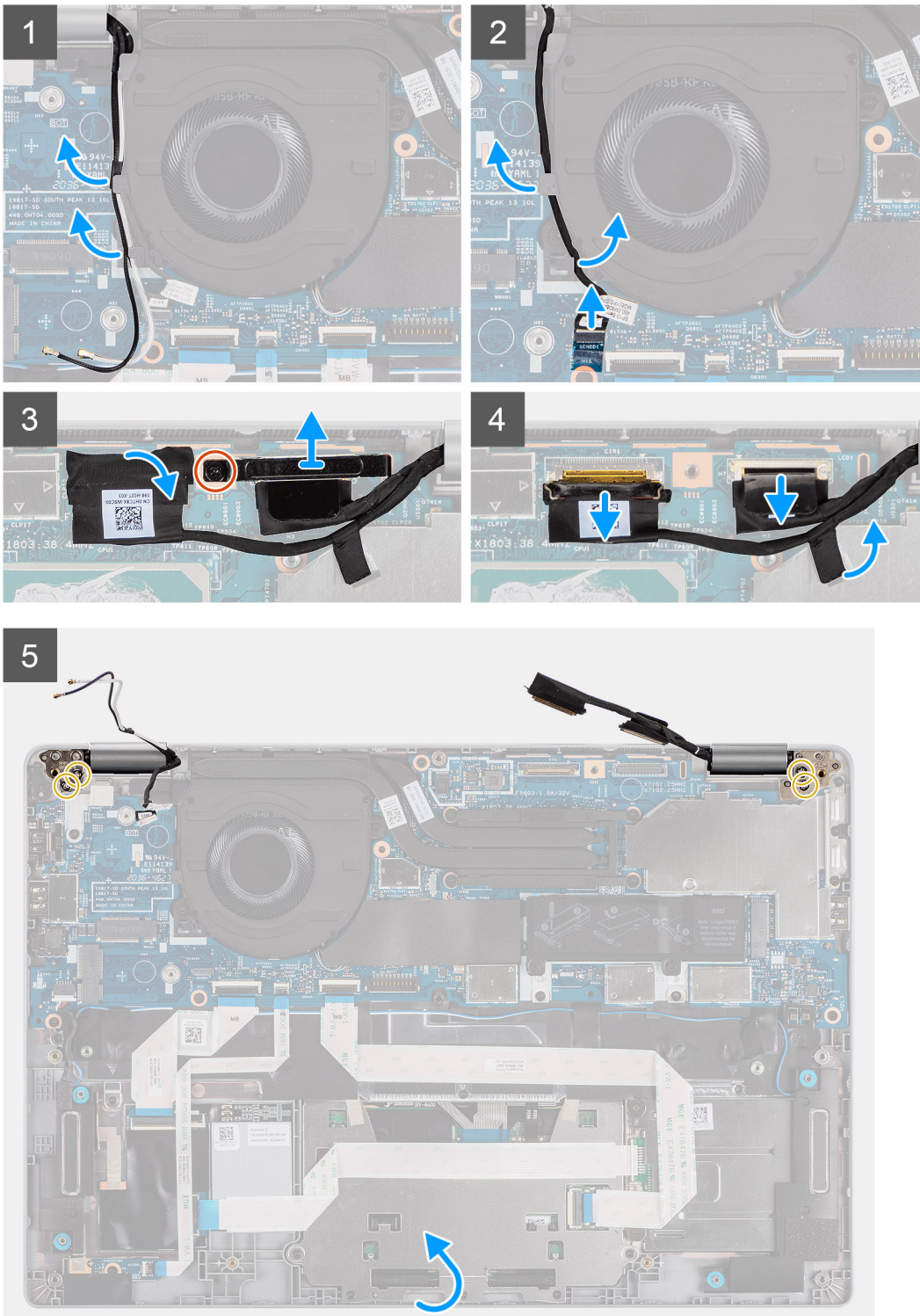
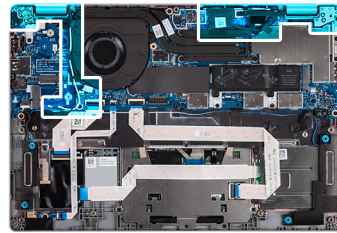

6

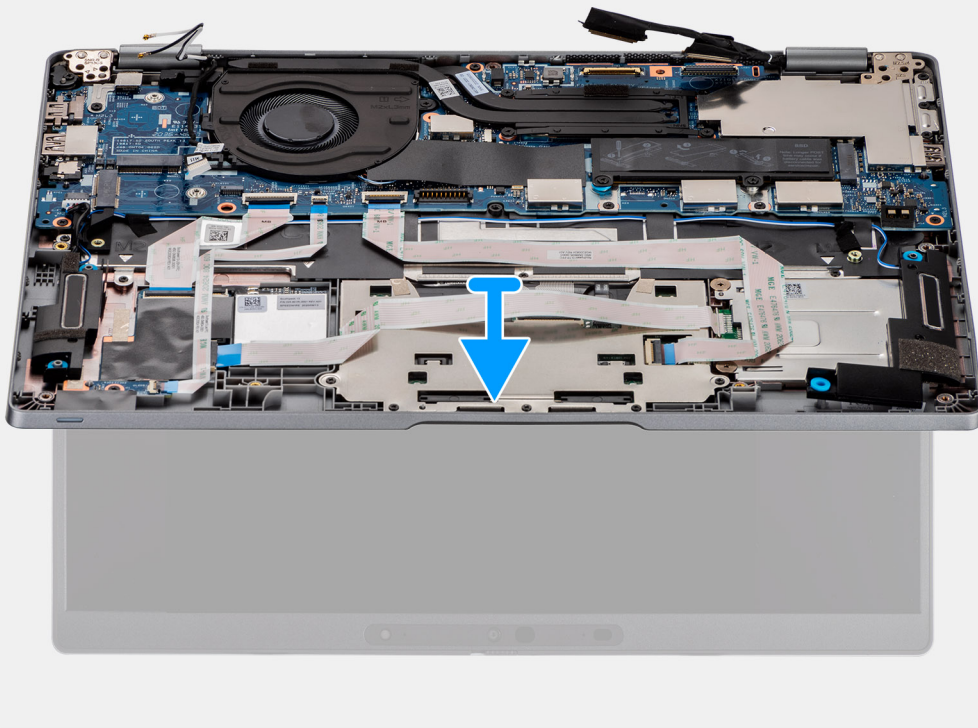

Steps

1. Unroute the antenna cables.
2. Disconnect the IR camera cable from its connector on the system board.
3. Unroute the IR camera cable from underneath the fan.
4. Remove the conductive tape covering the eDP cable.

5. Open the latch and disconnect the display eDP cable its connector on the system board.
6. Remove the single (M2x4) screw that secures the display cable bracket to the system board to release the display cable.
7. Remove the two screws (M2.5x4) that secure the left-display hinge to the system board.
8. Remove the two screws (M2.5x4) that secure the right-display hinge to the system board.
9. Open the display hinges at an angle of 90 degrees.
10. Gently slide the palm-rest and keyboard assembly off the display assembly carefully.

Installing the display assembly (laptop)

Prerequisites

If you are replacing a component, remove the existing component before performing the installation procedure.

About this task

The following image indicates the location of the display assembly and provides a visual representation of the installation procedure.

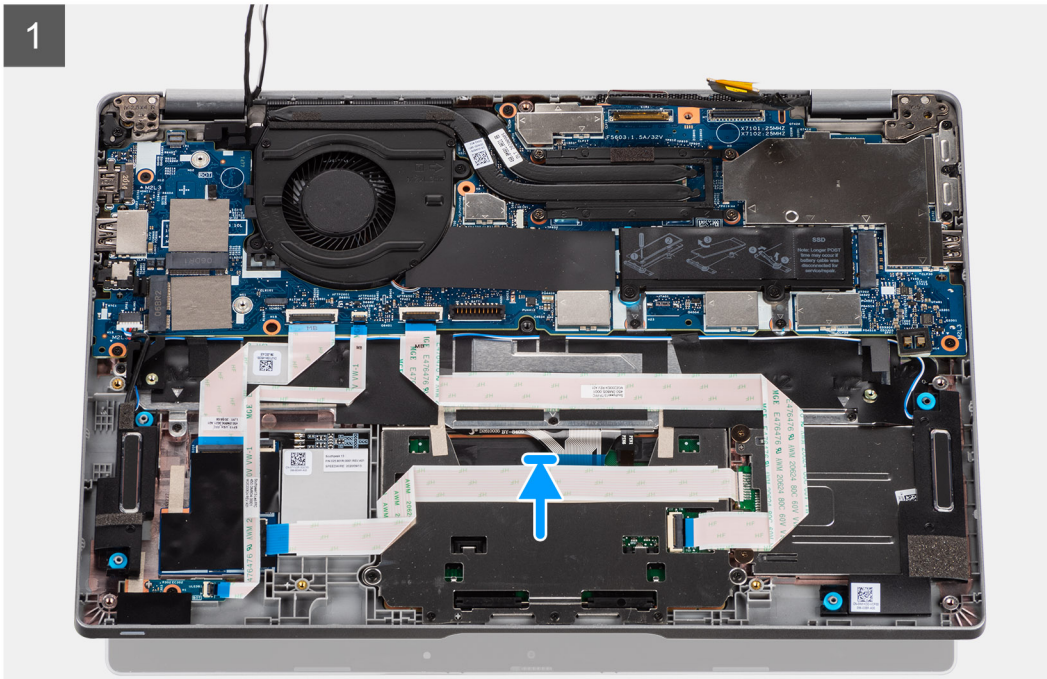
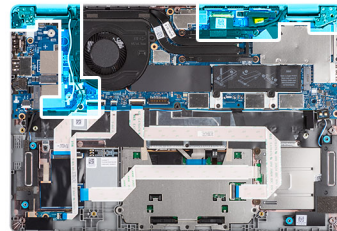

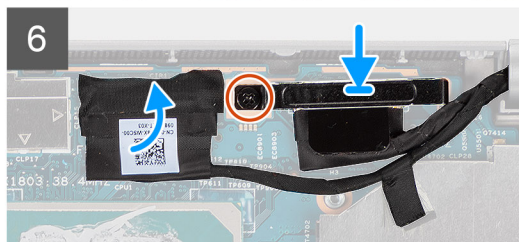
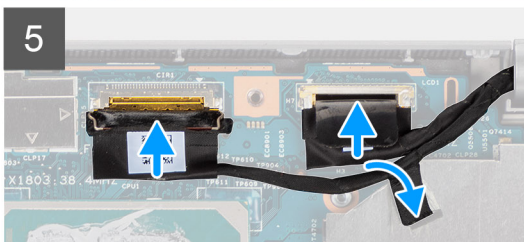
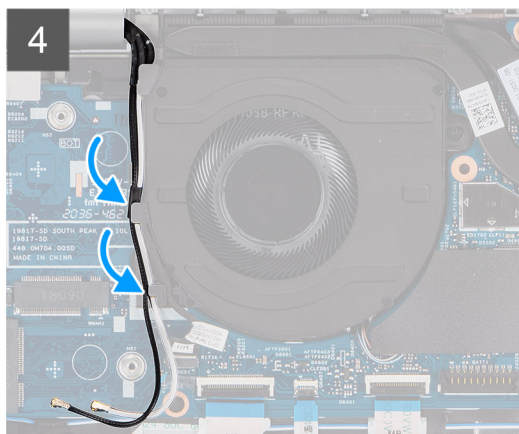
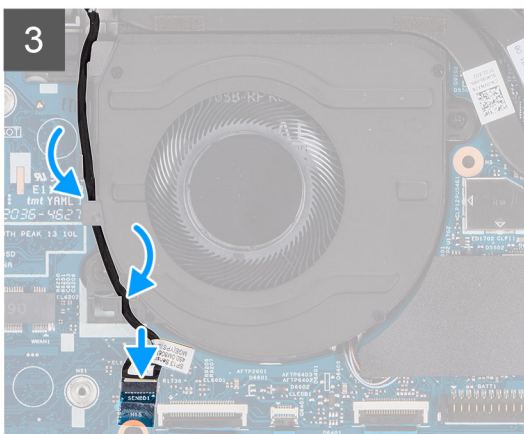
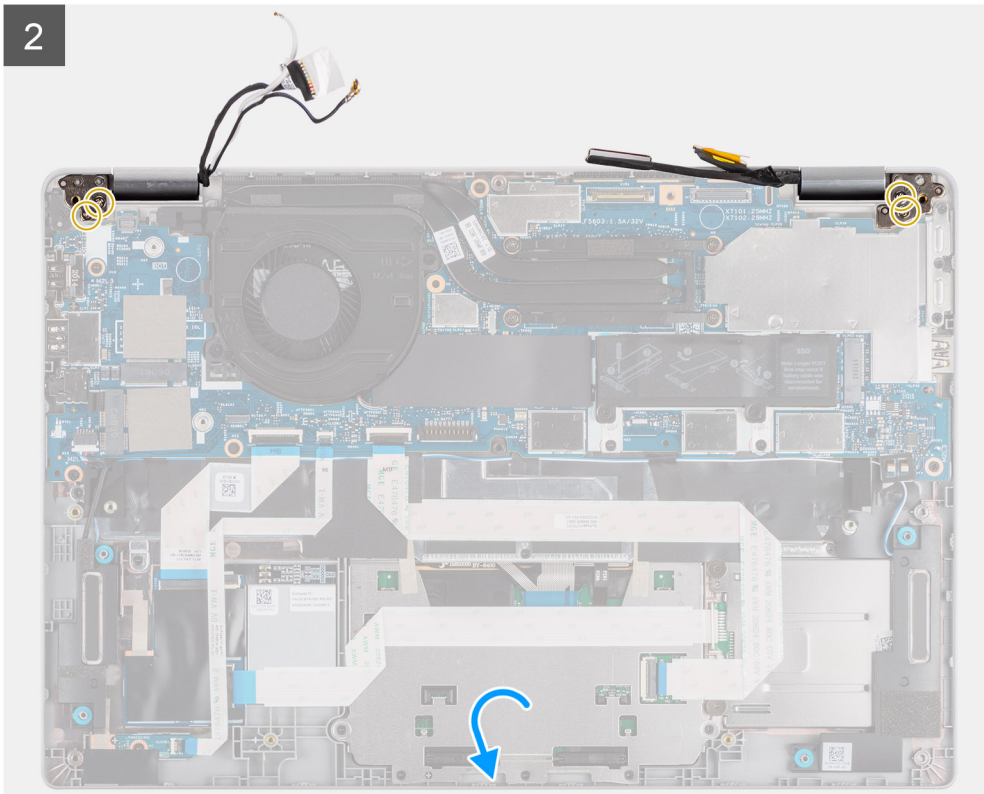

Steps

1. Place the display assembly on a clean and flat surface.
2. Align and place the palm-rest and keyboard assembly on the display assembly.
3. Using the alignment posts, close the display hinges.
4. Replace the two screws (M2.5x4) that secure the left-display hinge to the system board.
5. Replace the two screws (M2.5x4) that secure the right-display hinge to the system board.
6. Route the IR camera cable underneath the fan.
7. Connect the IR camera cable to its connector on the system board.

8. Route the antenna cables underneath the fan.
9. Connect the eDP cable on to its connector on the system board and adhere the conductive tape.
10. Connect the display cable to its connector on the system board.
11. Replace the single screw (M2x4) to secure the display cable bracket.

Next steps

1. Install the [battery](#).
2. Install the [WWAN card](#) (optional).
3. Install the [WLAN card](#).
4. Install the [base cover](#).
5. Follow the procedure in [after working inside your computer](#).

Removing the display assembly (2-in-1)

Prerequisites

1. Follow the procedure in [before working inside your computer](#).
2. Remove the [base cover](#).
3. Remove the [WLAN card](#).
4. Remove the [WWAN card](#) (optional).
5. Remove the [battery](#).

About this task

The following images indicate the location of the display assembly for 2-in-1 and provide a visual representation of the removal procedure.

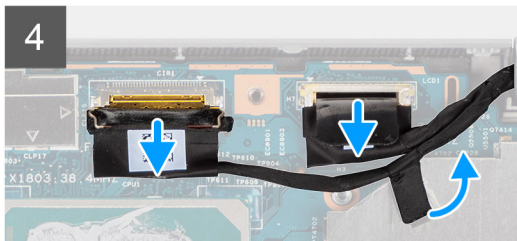
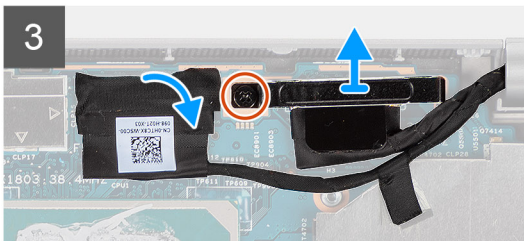
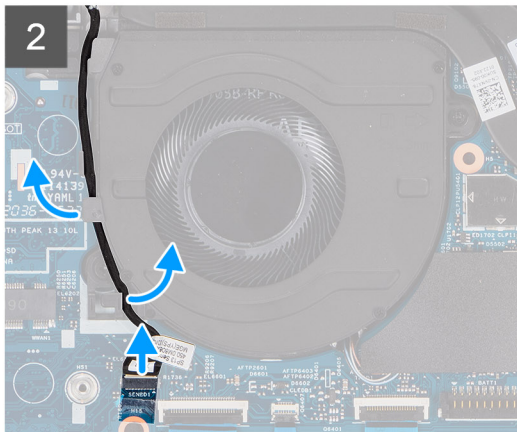
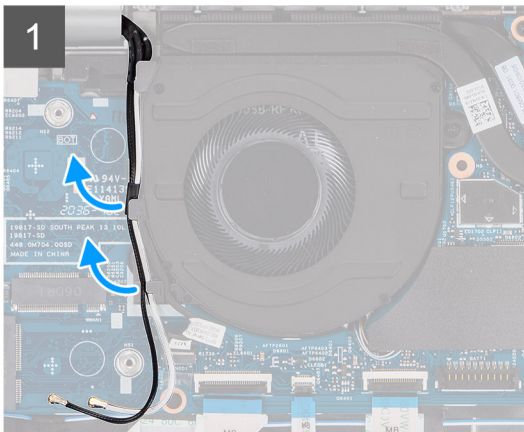
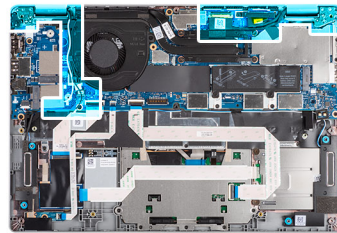

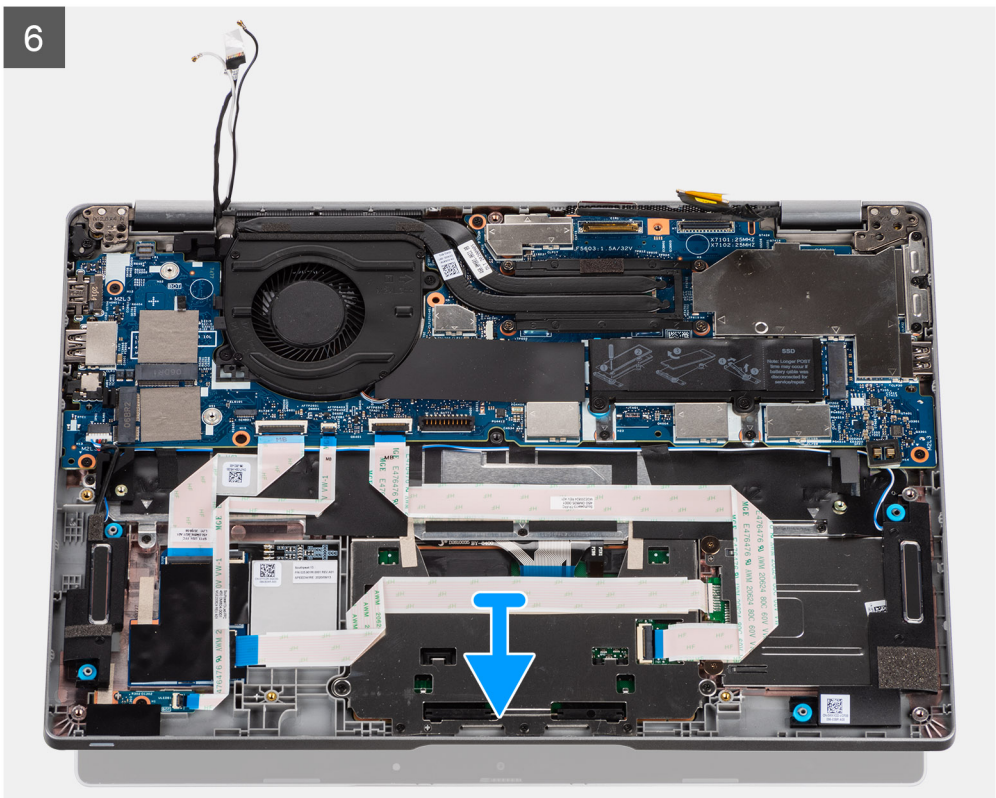
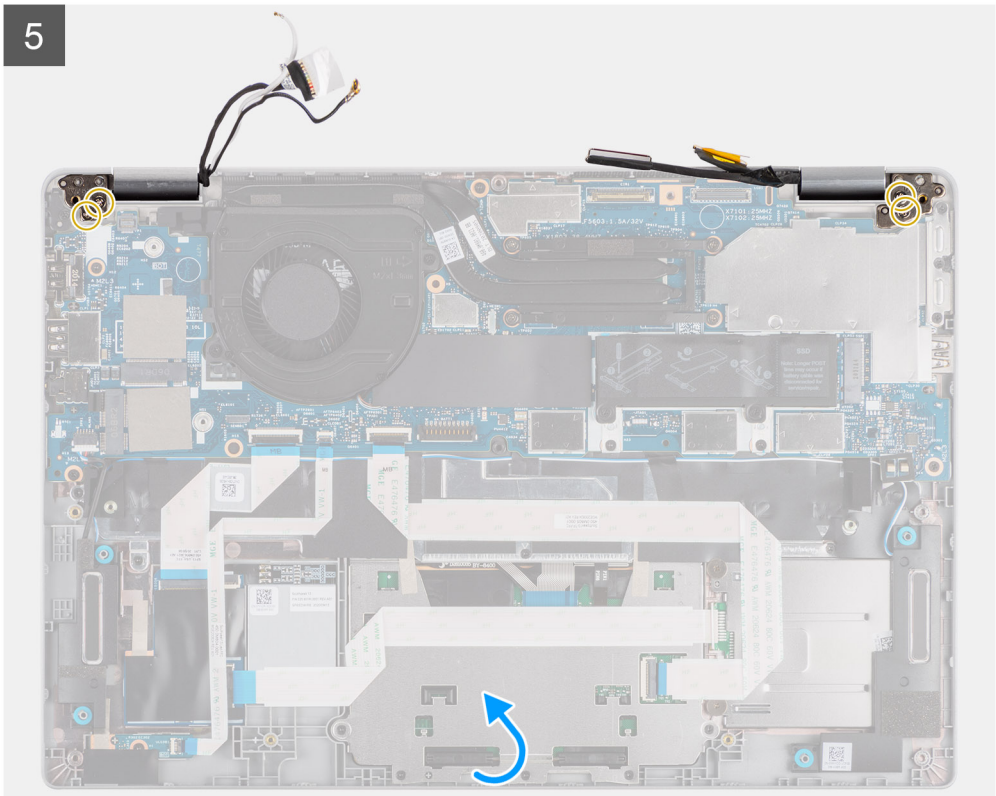



Steps

1. Unroute the antenna cables.
2. Disconnect the IR camera cable from its connector on the system board.
3. Unroute the IR camera cable from underneath the fan.
4. Remove the conductive tape covering the eDP cable.
5. Open the latch and disconnect the display eDP cable its connector on the system board.
6. Remove the single (M2x4) screw that secures the display cable bracket to the system board to release the display cable.
7. Remove the two screws (M2.5x4) that secure the left-display hinge to the system board.
8. Remove the two screws (M2.5x4) that secure the right-display hinge to the system board.
9. Open the display hinges at an angle of 90 degrees.
10. Gently slide the palm-rest and keyboard assembly off the display assembly carefully.

Installing the display assembly (2-in-1)

Prerequisites

If you are replacing a component, remove the existing component before performing the installation procedure.

About this task

The following image indicates the location of the display assembly for 2-in-1 and provides a visual representation of the installation procedure.



1x
M2x4



4x
M2.5x4

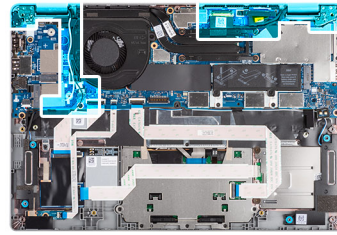

1

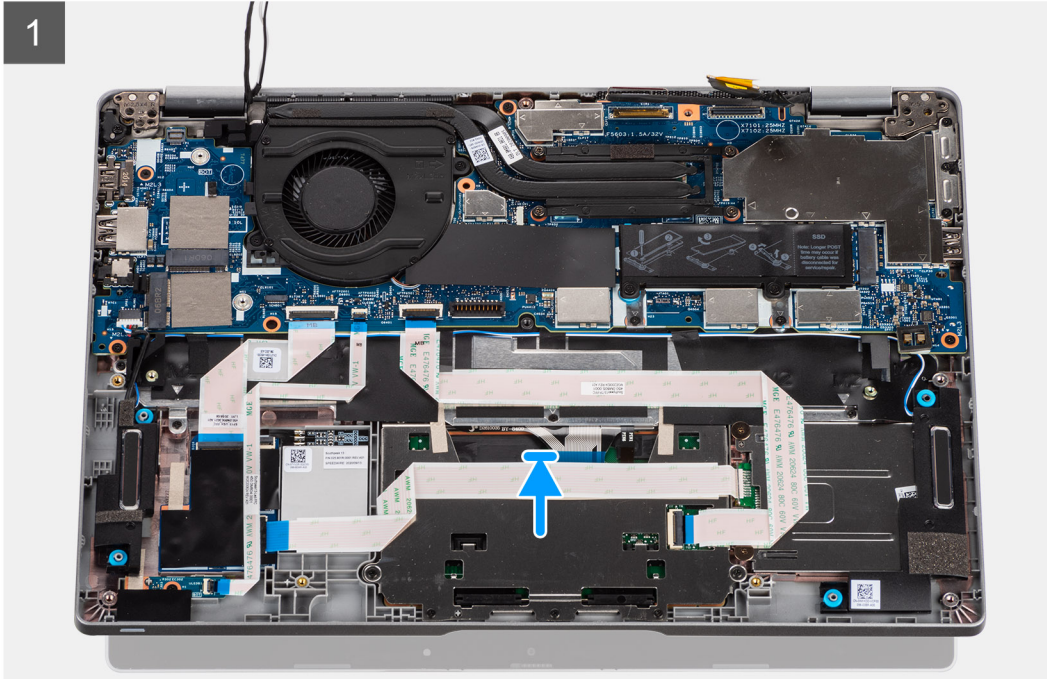

2

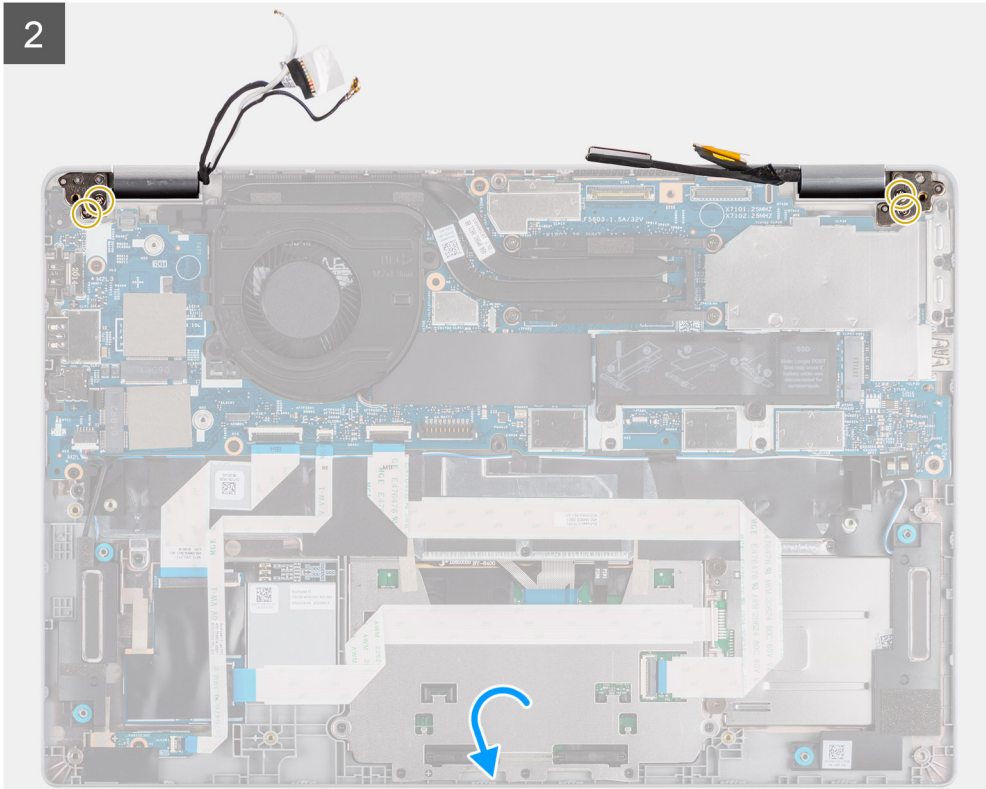

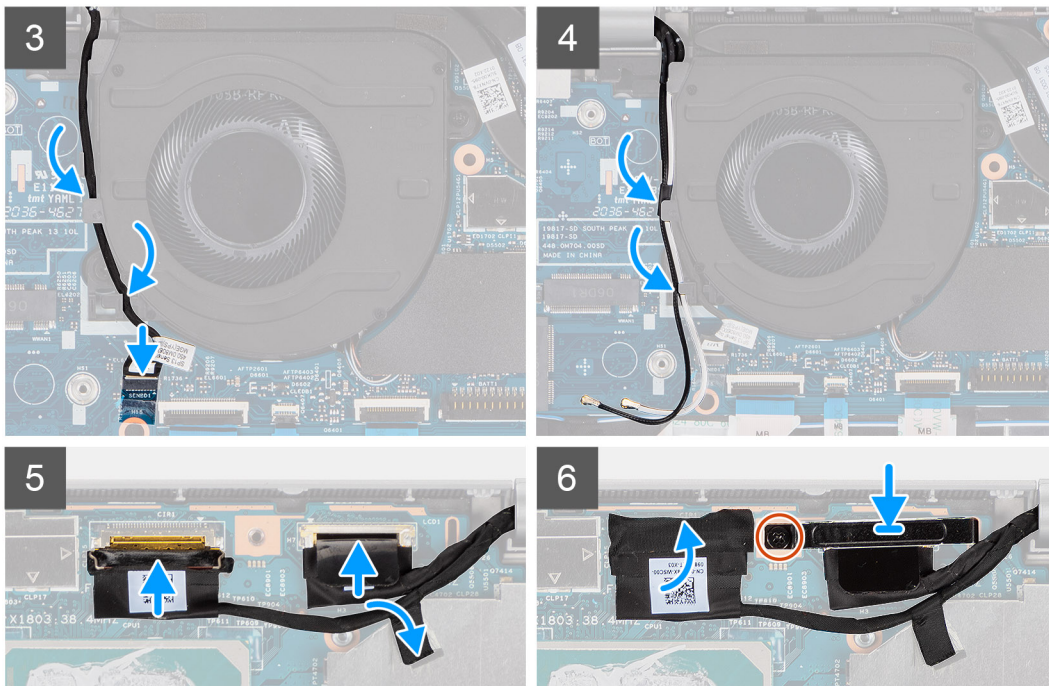

Steps

1. Place the display assembly on a clean and flat surface.
2. Align and place the palm-rest and keyboard assembly on the display assembly.
3. Using the alignment posts, close the display hinges.
4. Replace the two screws (M2.5x4) that secure the left-display hinge to the system board.
5. Replace the two screws (M2.5x4) that secure the right-display hinge to the system board.
6. Route the IR camera cable underneath the fan.
7. Connect the IR camera cable to its connector on the system board.
8. Route the antenna cables underneath the fan.
9. Connect the eDP cable on to its connector on the system board and adhere the conductive tape.
10. Connect the display cable to its connector on the system board.
11. Replace the single screw (M2x4) to secure the display cable bracket.

Next steps

1. Install the [battery](#).
2. Install the [WWAN card](#) (optional).
3. Install the [WLAN card](#).
4. Install the [base cover](#).
5. Follow the procedure in [after working inside your computer](#).

Display bezel

Removing the display bezel

Prerequisites

NOTE: The display bezel removal procedure is applicable only for Latitude 5320 laptop and not for the 2-in-1 configuration.

1. Follow the procedure in [before working inside your computer](#).
2. Remove the [base cover](#).
3. Remove the [battery](#).

4. Remove the [display assembly](#).

About this task

The following images indicate the location of the display bezel and provide a visual representation of the removal procedure.

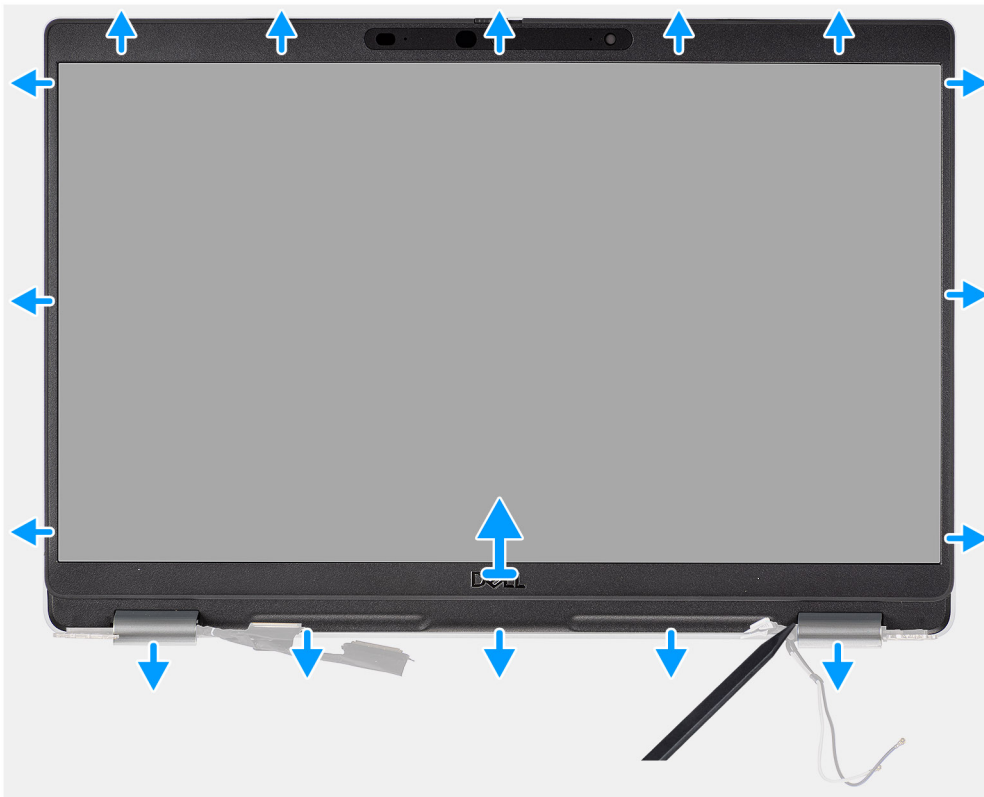

Steps

1. Insert a plastic scribe into the recesses near both the hinge caps to start the prying and release the display bezel.
 - i** **NOTE:** The display bezel is adhered to the display panel with adhesive. Disengage the adhesive from an X and Y axis or moving horizontally along the bezel to disengage the adhesive first before prying upwards.
 - i** **NOTE:** Carefully pry and remove the bezel to minimize risk of display panel damages.
2. Carefully pry along the outside edge of the display bezel and work your way around the entire display bezel until the display bezel is separated from the display cover.
 - i** **NOTE:** Do not use a plastic scribe or any other objects to pry up the display bezel in the manner that is shown in the image as the pressure applied on the display panel by the plastic scribe will damage the display panel.

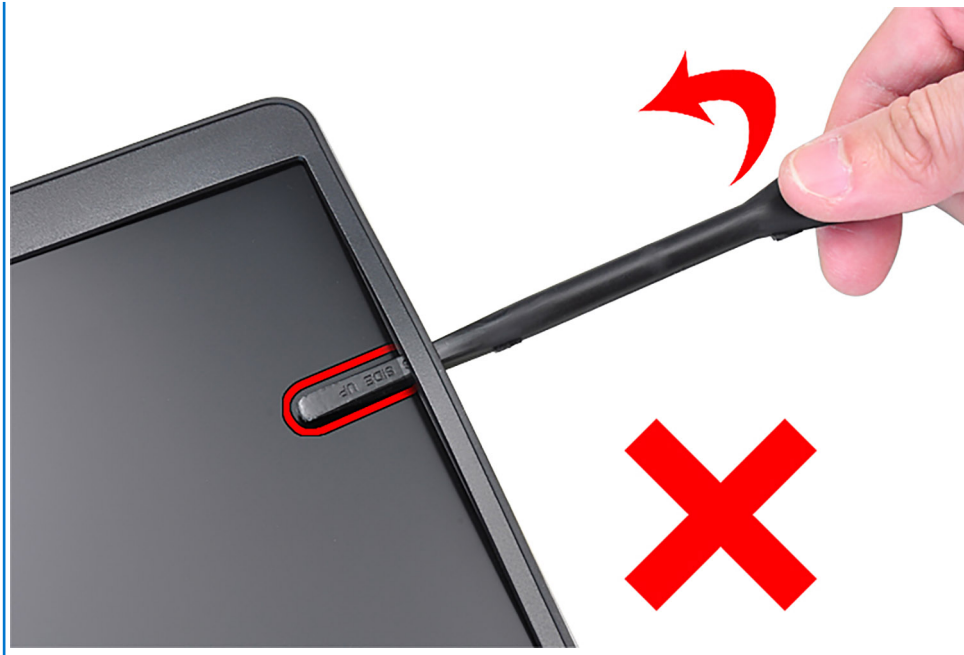

3. Remove the display bezel off the display back cover.

Installing the display bezel

Prerequisites

i **NOTE:** The display bezel installation procedure is applicable only for Latitude 5320 laptop and not for the 2-in-1 configuration.

If you are replacing a component, remove the existing component before performing the installation procedure.

About this task

The following image indicates the location of the display bezel and provides a visual representation of the installation procedure.

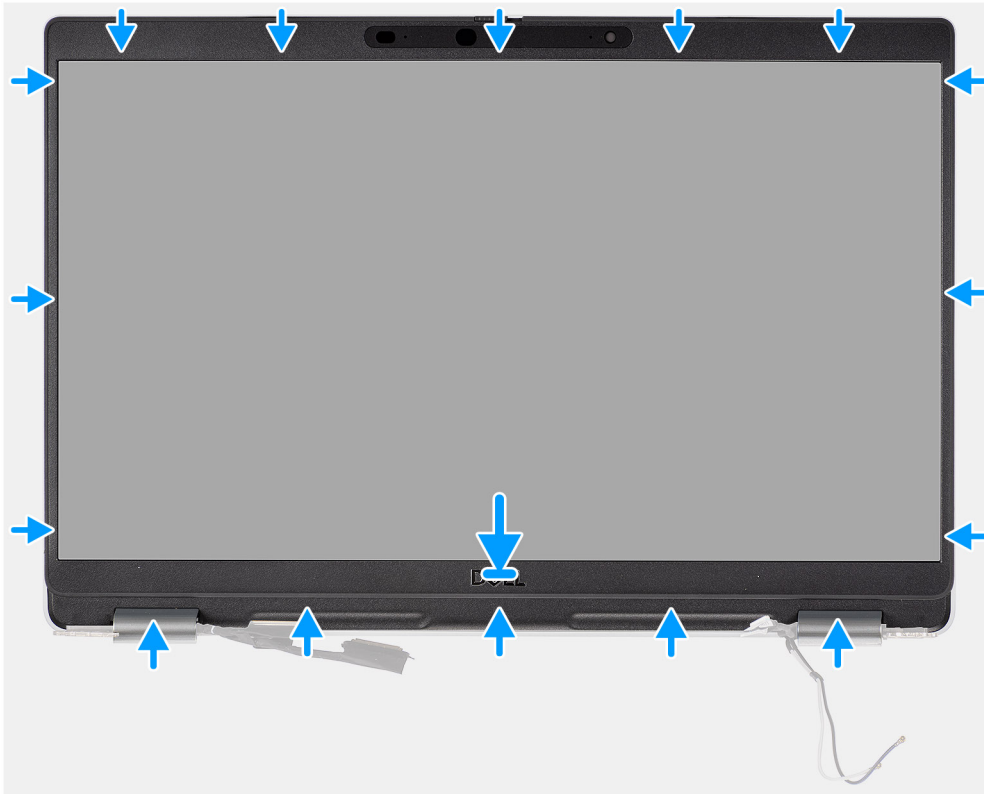

Steps

Align the display bezel with the display back-cover and antenna assembly, and gently snap the display bezel into place.

Next steps

1. Install the [display assembly](#).
2. Install the [battery](#).
3. Install the [base cover](#).
4. Follow the procedure in [after working inside your computer](#).

Display panel

Removing the display panel

Prerequisites

NOTE: The display panel removal procedure is applicable only for Latitude 5320 laptop and not for the 2-in-1 configuration.

NOTE: The display panel (touch and nontouch) and its support brackets are defined as a single assembly and cannot be further disassembled once it is removed from the display back cover. The support brackets are not to be removed from the display panel.

1. Follow the procedure in [before working inside your computer](#).
2. Remove the [base cover](#).
3. Remove the [battery](#).
4. Remove the [display assembly](#).
5. Remove the [display bezel](#).
6. Remove the [display hinges](#).

About this task

The following images indicate the location of the display panel and provide a visual representation of the removal procedure.



2x
M2x2.5

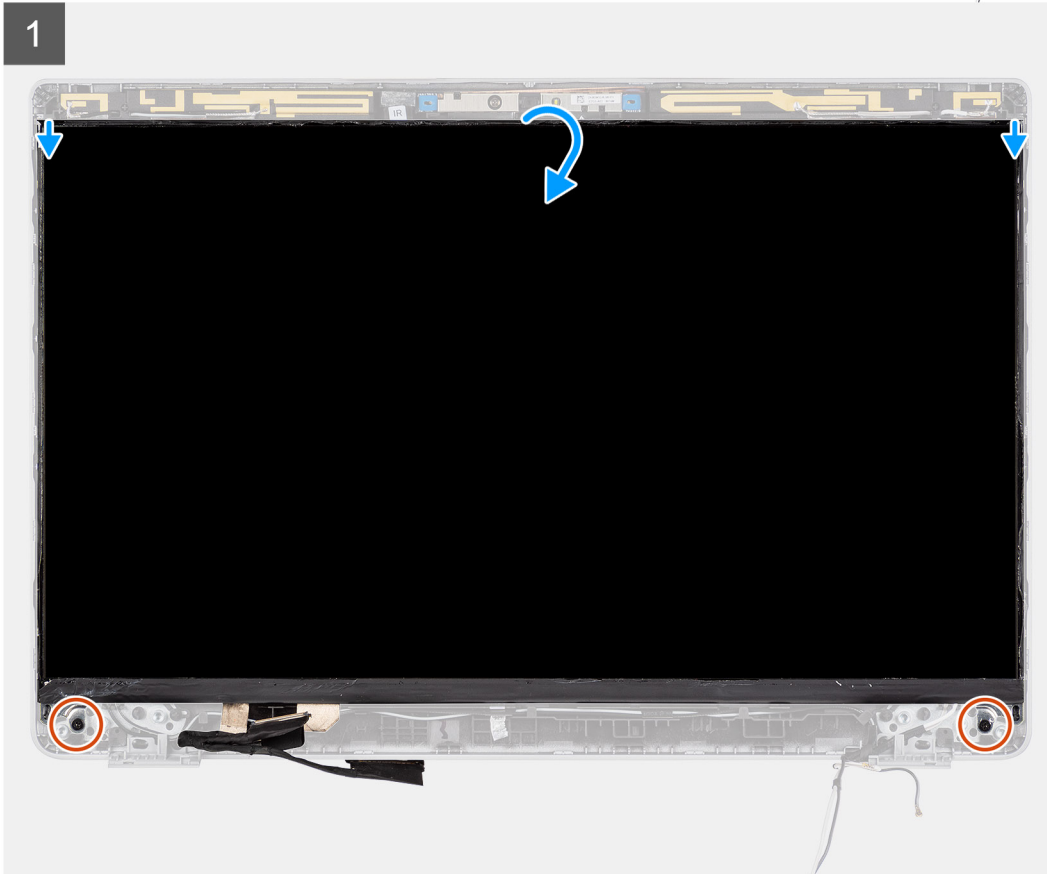

2

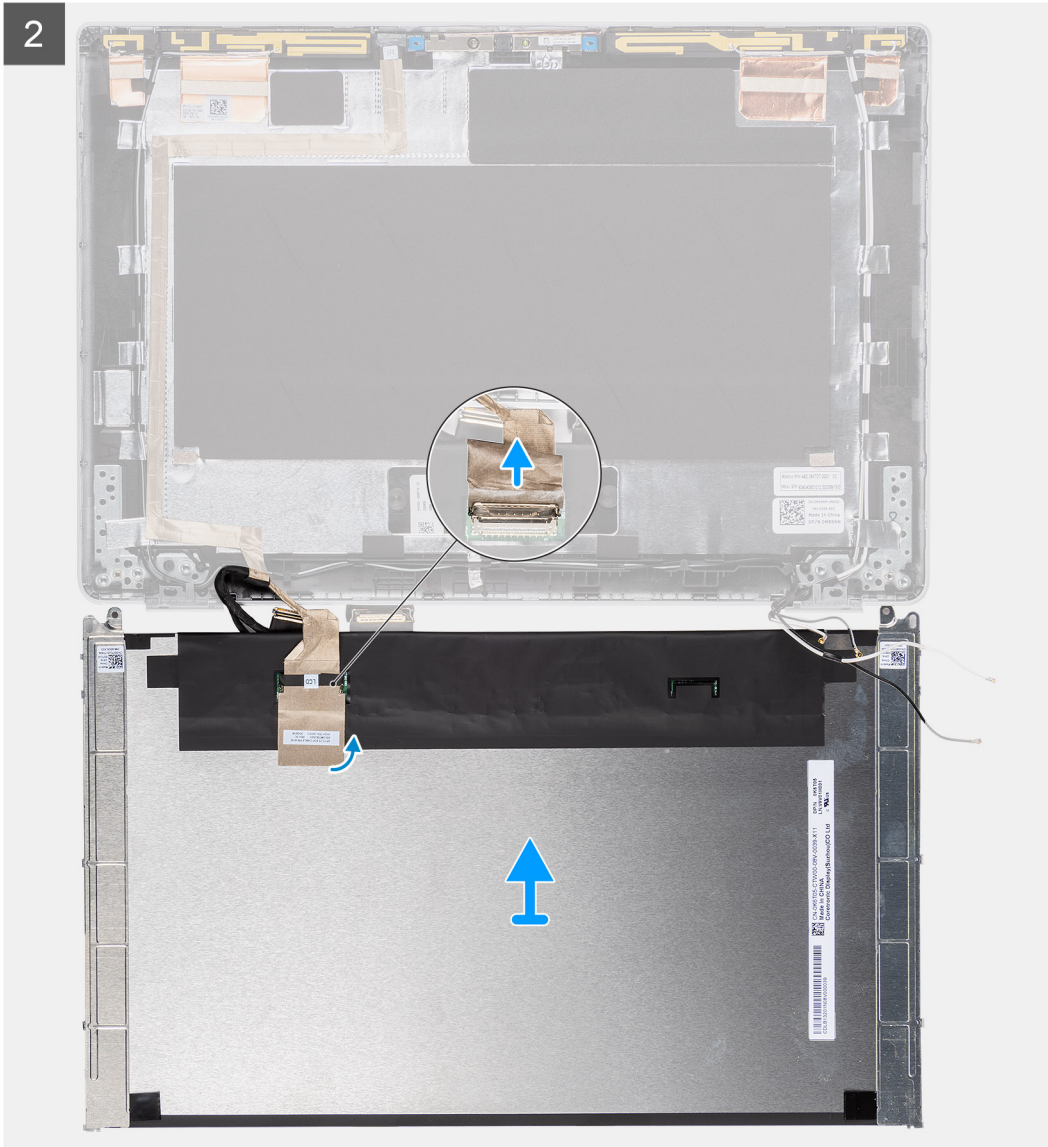



- i** **NOTE:** Do not pull and release the Stretch (SR) Tapes from the display panel. Separation of the brackets from the display panel is not required.
- i** **NOTE:** When removing the display panel, disengage the display panel tabs from the display cover before flipping it over for removal.

Steps

1. Remove the two (M2x2.5) screws that secure the display panel to the display assembly.
2. Lift to turn over the display panel to access the display cable.
3. Peel the conductive tape on the display cable connector.
4. Lift the latch and disconnect the display cable from the connector on the display panel.

Installing the display panel

Prerequisites

- i** **NOTE:** The display panel installation procedure is applicable only for Latitude 5320 laptop and not for the 2-in-1 configuration.
- i** **NOTE:** The display panel (touch and nontouch) and its support brackets are defined as a single assembly and cannot be further disassembled once it is removed from the display back cover. The support brackets are not to be removed from the display panel.
- i** **NOTE:** When installing the display panel, ensure that the display panel tabs are inserted into the slots on the display cover.

If you are replacing a component, remove the existing component before performing the installation procedure.

About this task

The following image indicates the location of the display panel and provides a visual representation of the installation procedure.

1

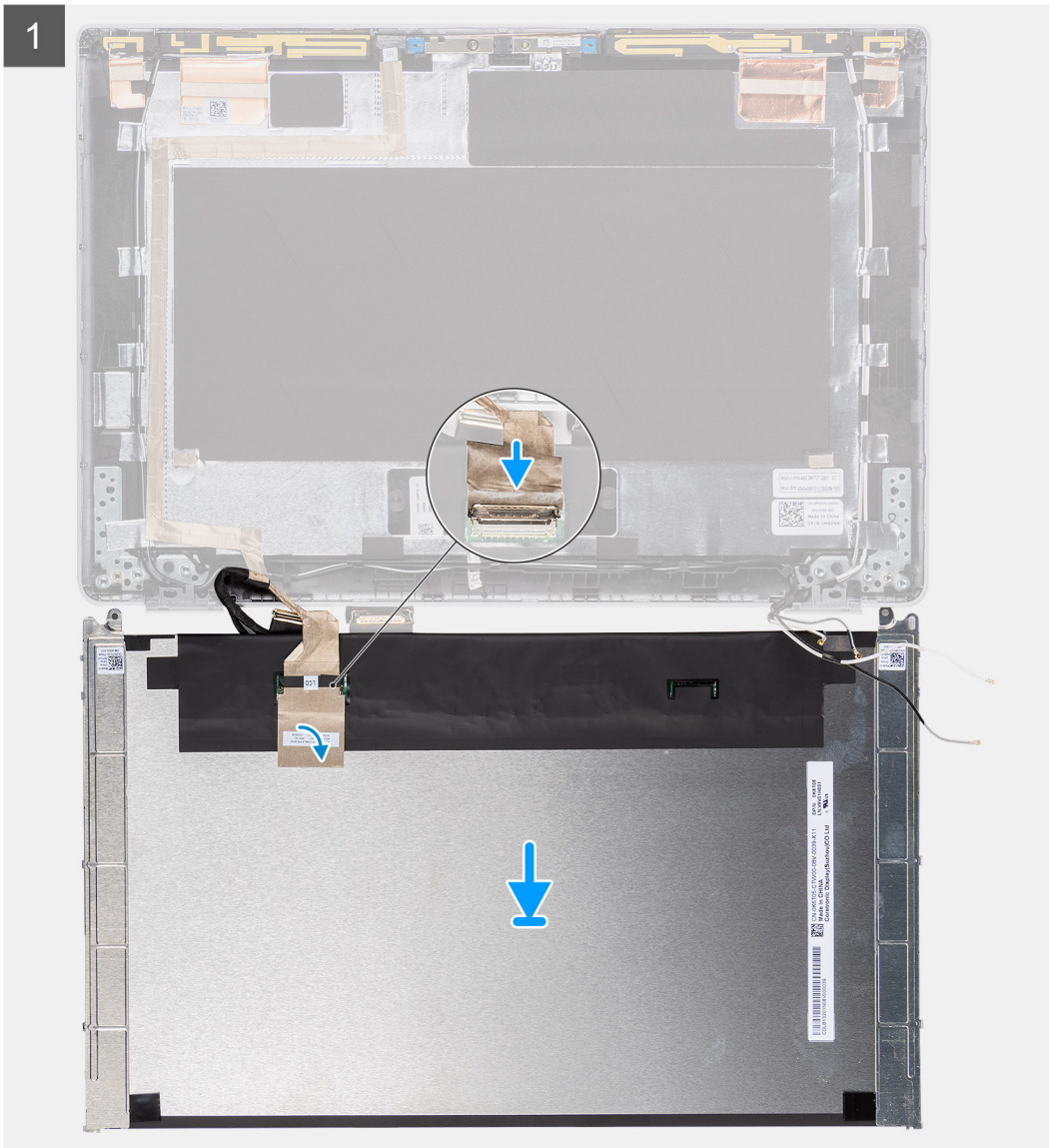



2x
M2x2.5

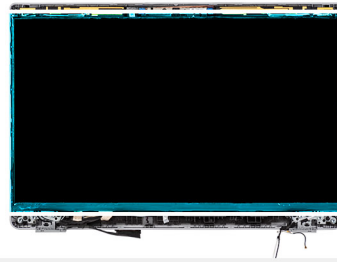

2

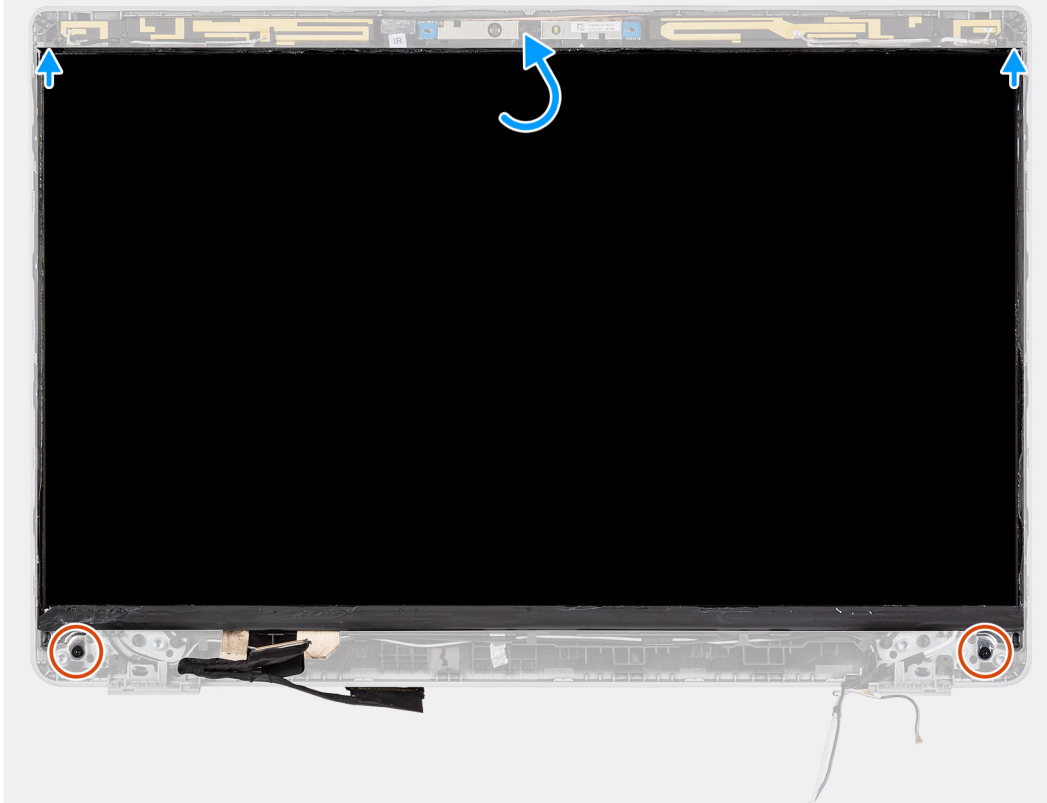

Steps

1. Connect the display cable to the connector and close the latch.
2. Adhere the adhesive strip to secure the display cable connector.
3. Insert the display panel tabs into the slots on the display cover.
4. Replace the two (M2x2.5) screws that secure the display panel to the display assembly.

Next steps

1. Install the [display hinges](#).
2. Install the [display bezel](#).
3. Install the [display assembly](#).
4. Install the [battery](#).
5. Install the [base cover](#).
6. Follow the procedure in [after working inside your computer](#).

Display hinges

Removing the display hinges

Prerequisites

i **NOTE:** The display hinge removal procedure is applicable only for Latitude 5320 laptop and not for the 2-in-1 configuration.

1. Follow the procedure in [before working inside your computer](#).
2. Remove the [base cover](#).
3. Remove the [battery](#).
4. Remove the [display assembly](#).

About this task

The following images indicate the location of the display hinges and provide a visual representation of the removal procedure.



6x
M2.5x3

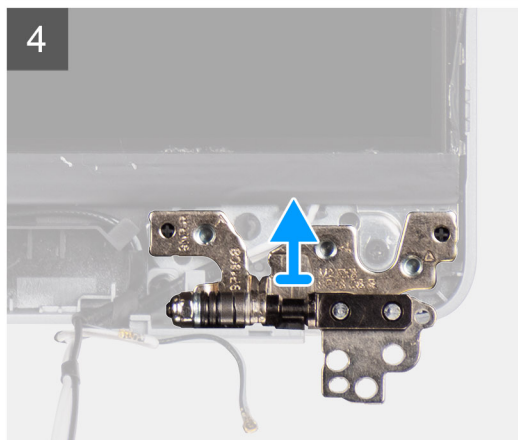
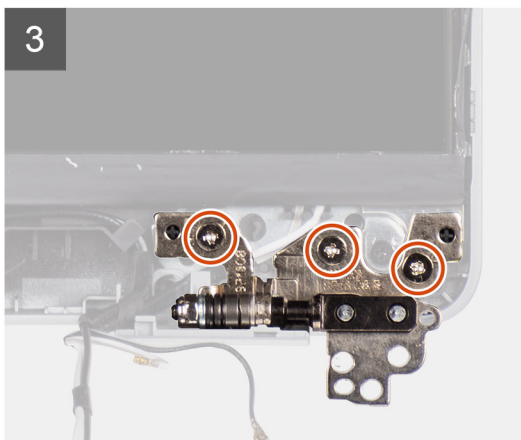
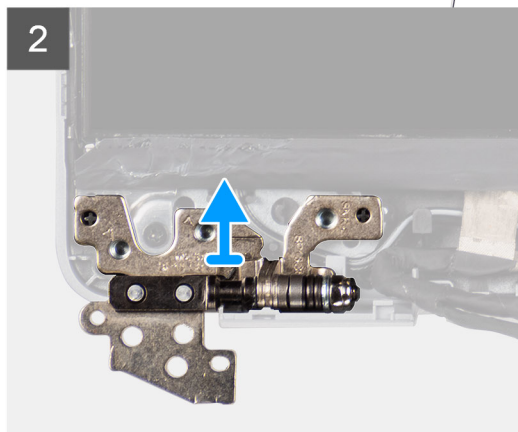
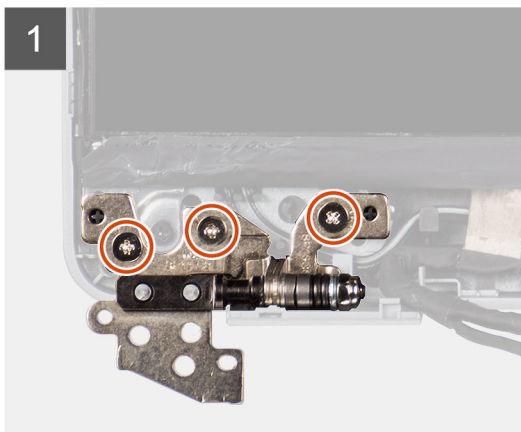

Steps

1. Remove the six (M2.5x3) screws that secure the right and left display hinges to the display back cover.
2. Remove the display hinges from the display back cover.

Installing the display hinges

Prerequisites

NOTE: The display hinge installation procedure is applicable only for Latitude 5320 laptop and not for the 2-in-1 configuration.

If you are replacing a component, remove the existing component before performing the installation procedure.

About this task

The following image indicates the location of the display hinges and provides a visual representation of the installation procedure.



6x
M2.5x3

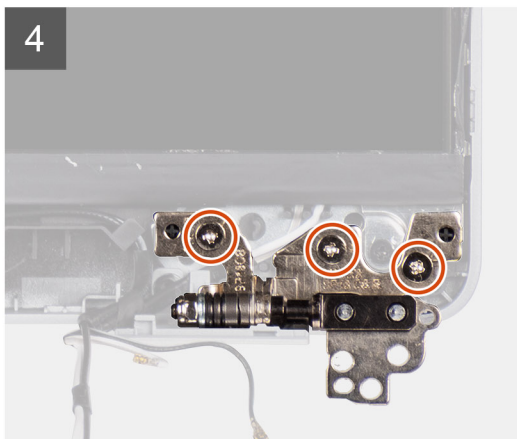
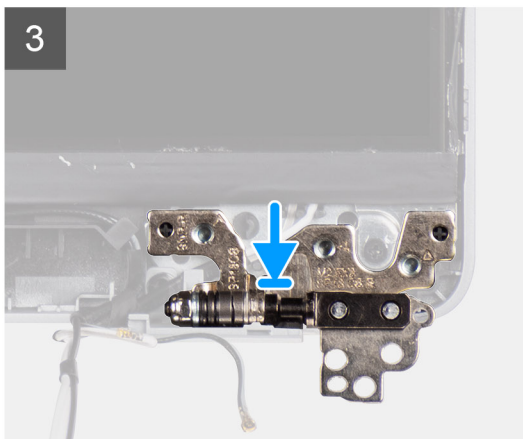
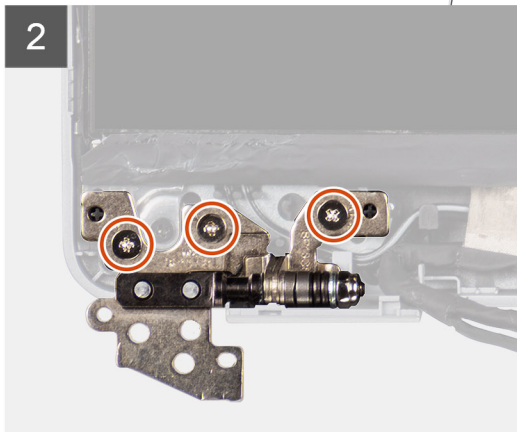
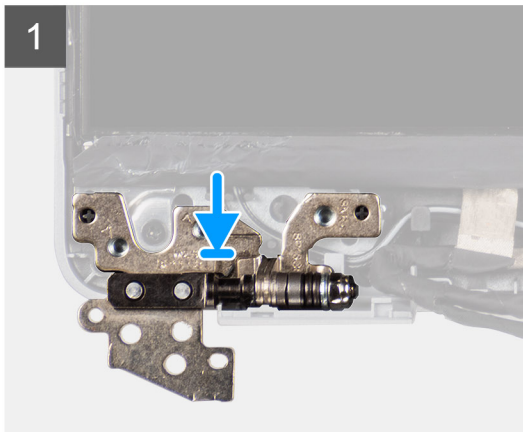
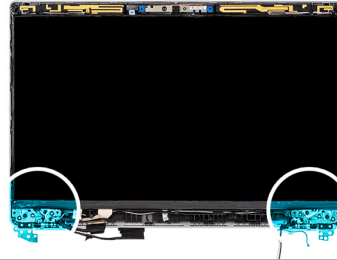

Steps

1. Lower the display hinges on the display assembly.
2. Replace the six (M2.5x3) screws to secure the left and right display hinges to the display back cover.

Next steps

1. Install the [display assembly](#).
2. Install the [battery](#).

3. Install the [base cover](#).
4. Follow the procedure in [after working inside your computer](#).

Display back cover assembly

Removing the display back-cover

Prerequisites

i **NOTE:** The display back-cover removal procedure is applicable only for Latitude 5320 laptop and not for the 2-in-1 configuration.

1. Follow the procedure in [before working inside your computer](#).
2. Remove the [base cover](#).
3. Remove the [battery](#).
4. Remove the [display assembly](#).
5. Remove the [display bezel](#).
6. Remove the [display hinges](#).
7. Remove the [display panel](#).
8. Remove the [camera](#).
9. Remove the [eDP cable](#).

About this task

The following images indicate the location of the display back-cover and provide a visual representation of the removal procedure.

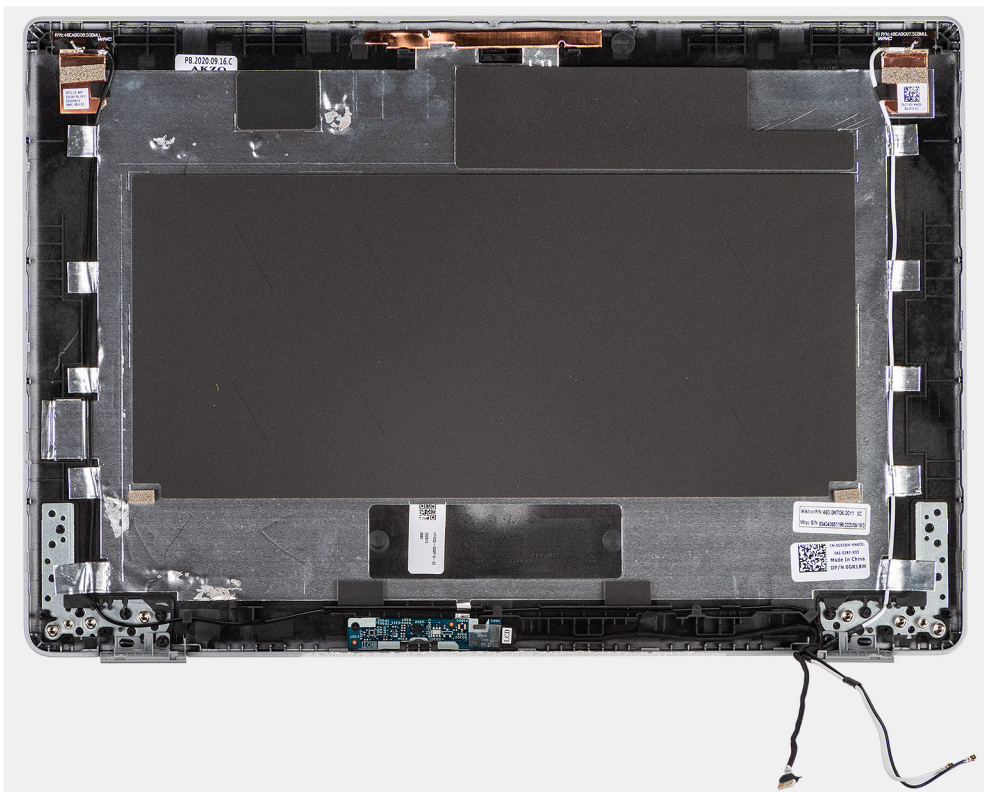

Steps

After performing the preceding steps, you are left with the display back cover.

Installing the display back-cover

Prerequisites

NOTE: The display back-cover installation procedure is applicable only for Latitude 5320 laptop and not for the 2-in-1 configuration.

If you are replacing a component, remove the existing component before performing the installation procedure.

About this task

The following image indicates the location of the display back-cover and provides a visual representation of the installation procedure.

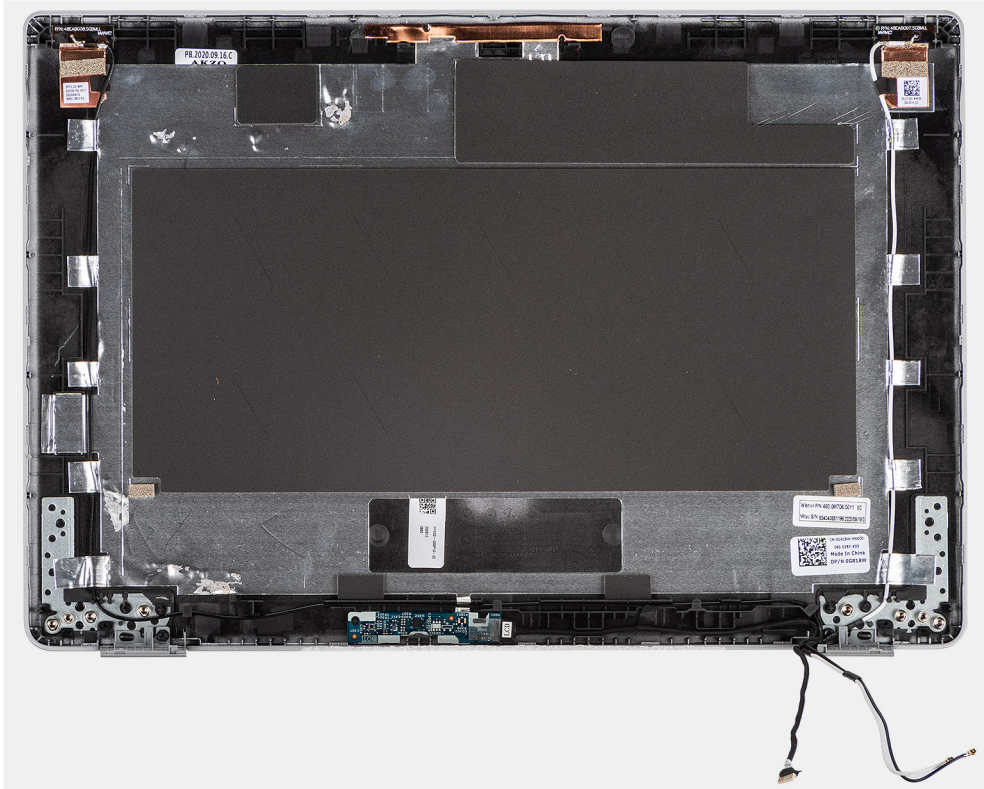

Steps

Place the display back-cover on a flat surface and perform the following steps to install the display back cover.

Next steps

1. Install the [eDP cable](#).
2. Install the [camera](#).
3. Install the [display panel](#).
4. Install the [display hinges](#).
5. Install the [display bezel](#).
6. Install the [display assembly](#).
7. Install the [battery](#).
8. Install the [base cover](#).
9. Follow the procedure in [after working inside your computer](#).

eDP cable

Removing the eDP cable

Prerequisites

i **NOTE:** The eDP cable removal procedure is applicable only for Latitude 5320 laptop and not for the 2-in-1 configuration.

1. Follow the procedure in [before working inside your computer](#).
2. Remove the [base cover](#).
3. Remove the [battery](#).
4. Remove the [display assembly](#).
5. Remove the [display bezel](#).
6. Remove the [display hinges](#).
7. Remove the [display panel](#).

About this task

The following images indicate the location of the eDP cable and provide a visual representation of the removal procedure.

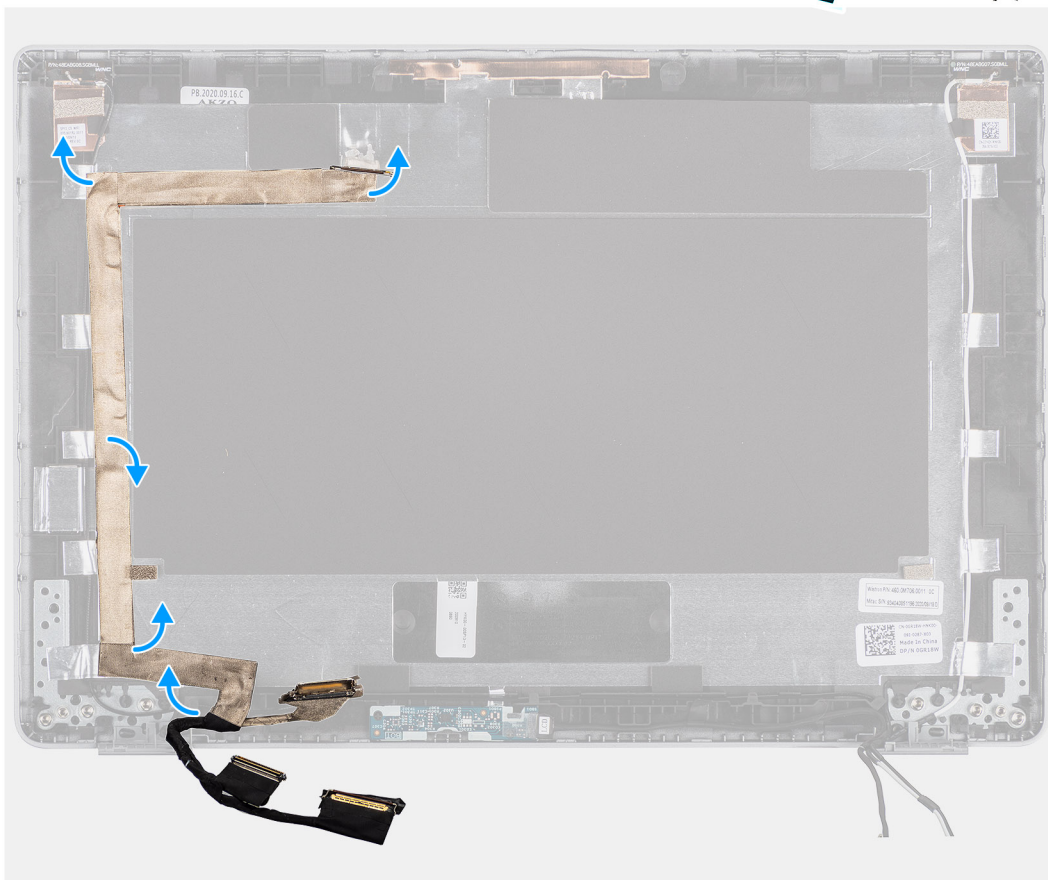

Steps

1. Peel off the tape securing the eDP cable to the back cover.
2. Remove the eDP cable from the system.

Installing the eDP cable

About this task

i **NOTE:** The eDP cable installation procedure is applicable only for Latitude 5320 laptop and not for the 2-in-1 configuration.

The following image indicates the location of the eDP cable and provides a visual representation of the installation procedure.

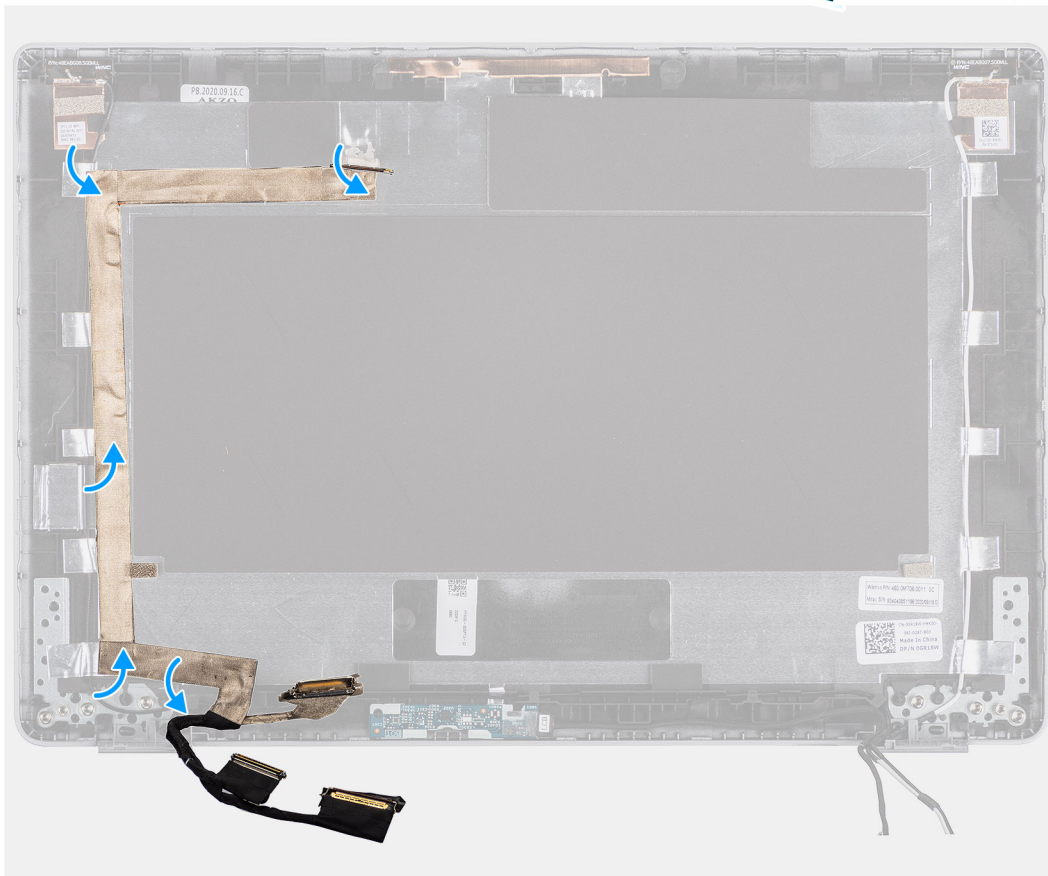
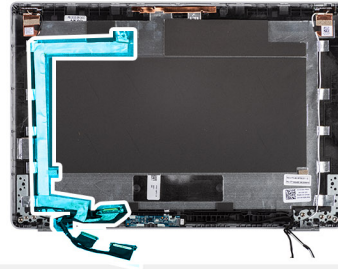

Steps

Adhere the tape to securing the eDP cable to the display back cover.

Next steps

1. Install the [display panel](#).
2. Install the [display hinges](#).
3. Install the [display bezel](#).
4. Install the [display assembly](#).

5. Install the [battery](#).
6. Install the [base cover](#).
7. Follow the procedure in [After working inside your computer](#).

Sensor board

Removing the sensor board

Prerequisites

1. Follow the procedure in [before working inside your computer](#).
2. Remove the [base cover](#).
3. Remove the [battery](#).
4. Remove the [display assembly](#).
5. Remove the [display bezel](#).
6. Remove the [display panel](#).

About this task

The following images indicate the location of the sensor board and provide a visual representation of the removal procedure.

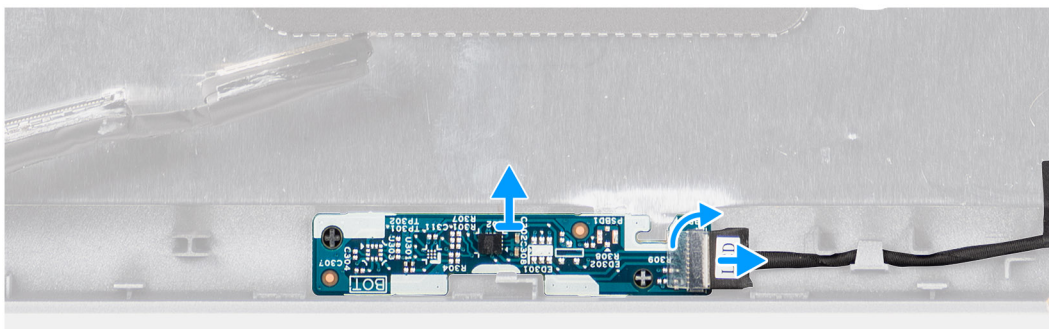
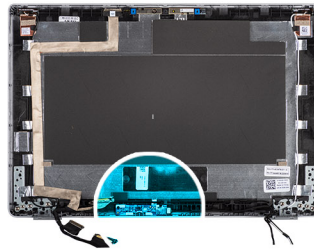

Steps

1. Open the latch and disconnect the display cable from connector on the sensor board.
2. Gently lift the sensor board away from the display back cover.

Installing the sensor board

About this task

The following images indicate the location of the sensor board and provide a visual representation of the removal procedure.

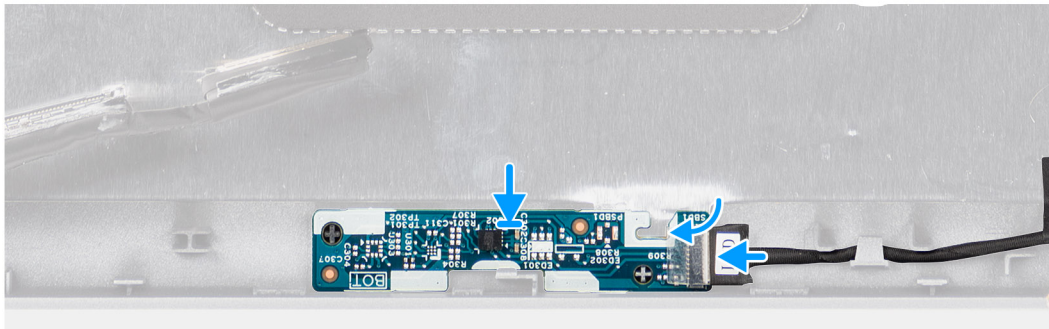
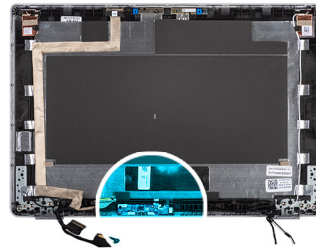

Steps

1. Align and place the sensor board on the display back cover.
2. Connect the display cable to the connector on the sensor board and close the latch.

Next steps

1. Install the [display panel](#).
2. Install the [display bezel](#).
3. Install the [display assembly](#).
4. Install the [battery](#).
5. Install the [base cover](#).
6. Follow the procedure in [After working inside your computer](#).

LED board

Removing the LED board

Prerequisites

1. Follow the procedure in [before working inside your computer](#).
2. Remove the [base cover](#).
3. Remove the [battery](#).

About this task

The following image indicates the location of the LED board and provides a visual representation of the removal procedure.



1x
M2x3

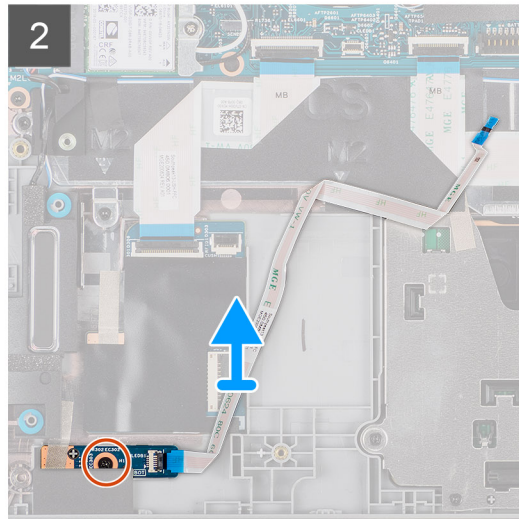
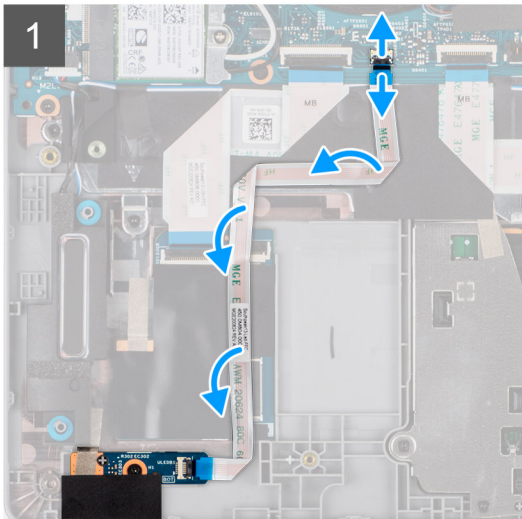
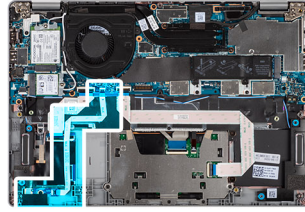

Steps

1. Open the latch and disconnect the LED-board cable from its connector on the system board and LED board.
2. Remove the single screw (M2x3) that secures the LED board to the palm-rest assembly.
3. Lift the LED board and cable away from the palm-rest assembly.

Installing the LED board

Prerequisites

If you are replacing a component, remove the existing component before performing the installation procedure.

About this task

The following image indicates the location of the LED board and provides a visual representation of the installation procedure.



1x
M2x3

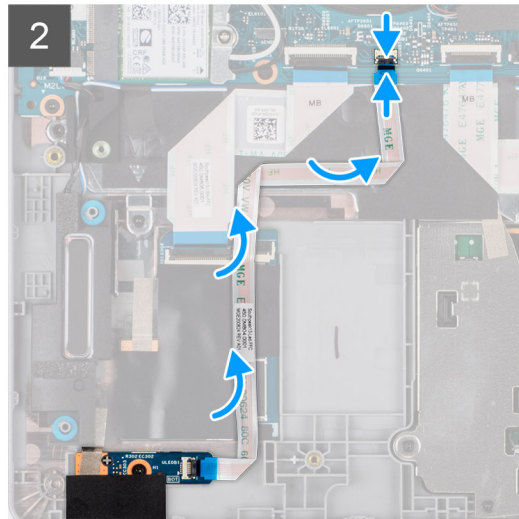
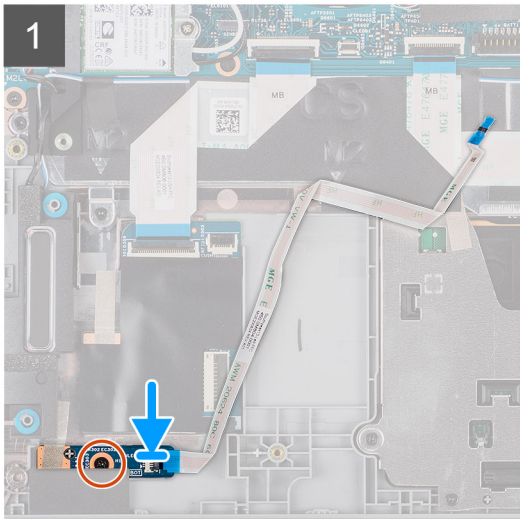
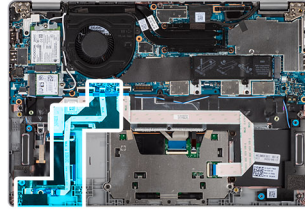

Steps

1. Align the screw hole on the LED board with the screw hole on the palm-rest assembly.
2. Replace the single screw (M2x3) to secure the LED board to the palm-rest assembly.
3. Route the LED-board cable and connect the cable to the connector on the LED board and the system board.

Next steps

1. Install the [battery](#).
2. Install the [base cover](#).
3. Follow the procedure in [after working inside your computer](#).

Camera

Removing the camera

Prerequisites

NOTE: The camera removal procedure is applicable only for Latitude 5320 laptop and not for the 2-in-1 configuration.

1. Follow the procedure in [before working inside your computer](#).
2. Remove the [base cover](#).
3. Remove the [battery](#).
4. Remove the [display assembly](#).
5. Remove the [display bezel](#).
6. Remove the [display hinges](#).
7. Remove the [display panel](#).

About this task

The following images indicate the location of the camera and provide a visual representation of the removal procedure.

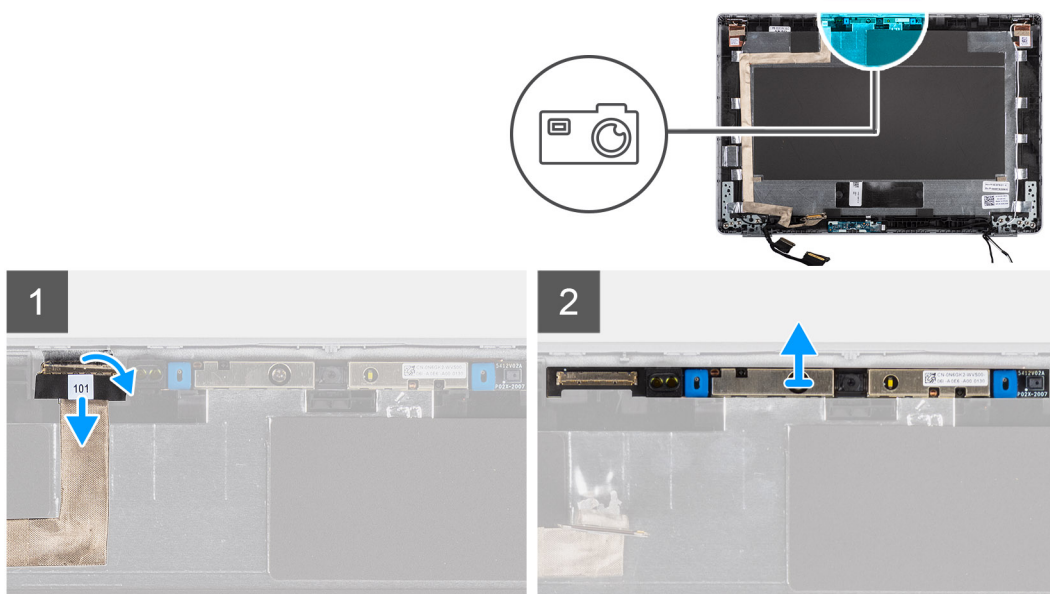

Steps

1. Peel the conductive tape that secures the camera cable in place.
2. Lift the latch and disconnect the camera cable from the connector on the camera module.
3. Carefully pry and lift the camera module from the display back cover.

Installing the camera

Prerequisites

NOTE: The camera installation procedure is applicable only for Latitude 5320 laptop and not for the 2-in-1 configuration.

If you are replacing a component, remove the existing component before performing the installation procedure.

About this task

The following image indicates the location of the camera and provides a visual representation of the installation procedure.

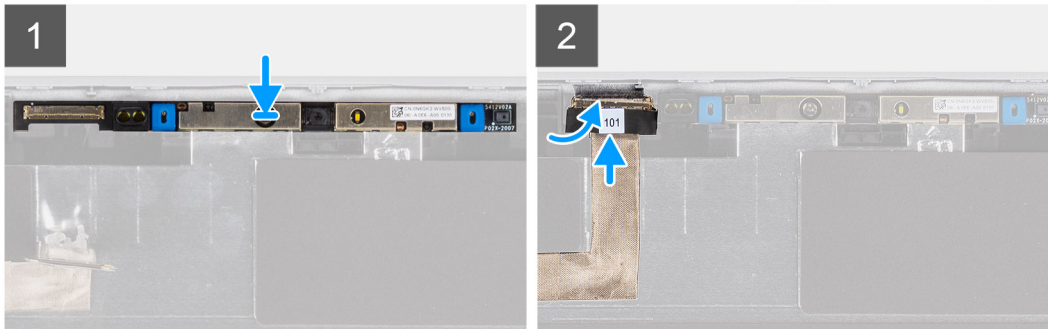
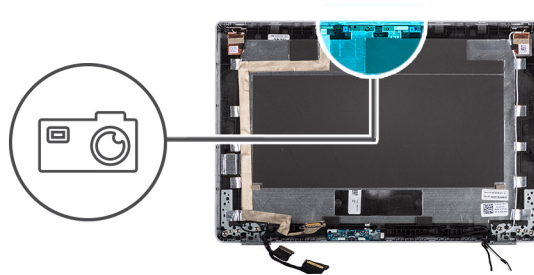

Steps

1. Insert the camera into the slot on the display back cover.
2. Connect the camera cable to the connector and adhere the adhesive tape above the camera connector.

Next steps

1. Install the [display panel](#).
2. Install the [display hinges](#).
3. Install the [display bezel](#).
4. Install the [display assembly](#).
5. Install the [battery](#).
6. Install the [base cover](#).
7. Follow the procedure in [after working inside your computer](#).

Removing the infrared camera

Prerequisites

NOTE: The infrared camera removal procedure is applicable only for Latitude 5320 laptop and not for the 2-in-1 configuration.

1. Follow the procedure in [before working inside your computer](#).
2. Remove the [base cover](#).
3. Remove the [battery](#).
4. Remove the [display assembly](#).
5. Remove the [display bezel](#).
6. Remove the [display hinges](#).
7. Remove the [display panel](#).

About this task

The following images indicate the location of the infrared camera and provide a visual representation of the removal procedure.

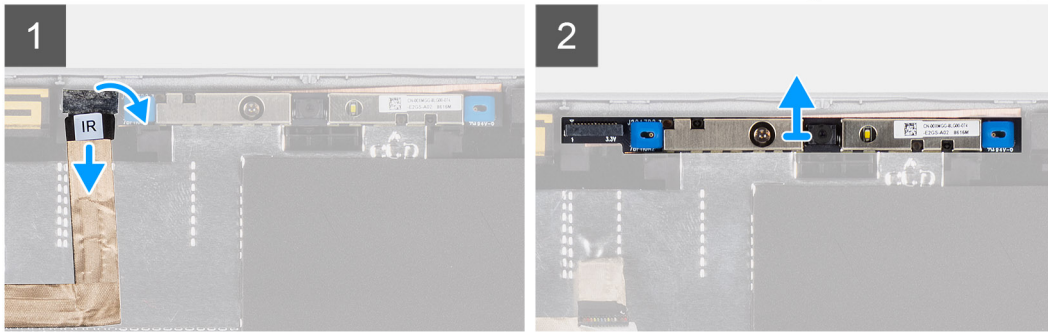
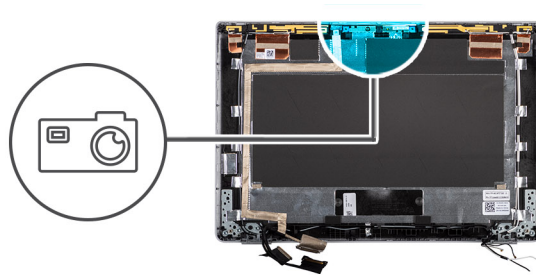

Steps

1. Peel the conductive tape that secures the IR camera cable in place.
2. Disconnect the IR camera cable from the connector on the camera module.
3. Carefully pry and lift the camera module from the display back cover.

Installing the infrared camera

Prerequisites

NOTE: The infrared camera installation procedure is applicable only for Latitude 5320 laptop and not for the 2-in-1 configuration.

If you are replacing a component, remove the existing component before performing the installation procedure.

About this task

The following image indicates the location of the infrared camera and provides a visual representation of the installation procedure.

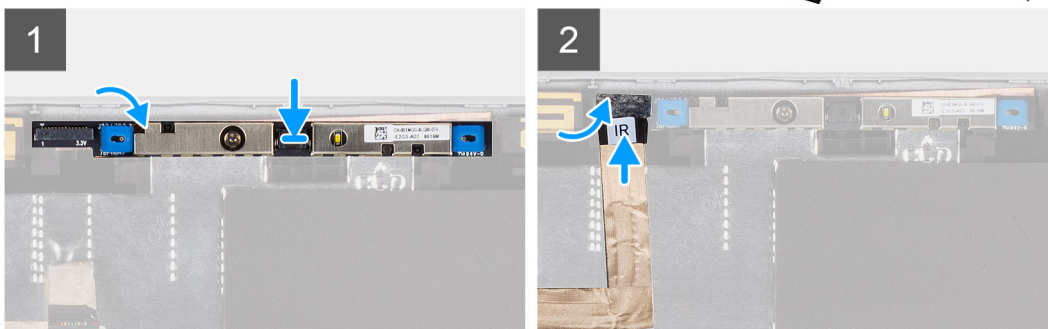
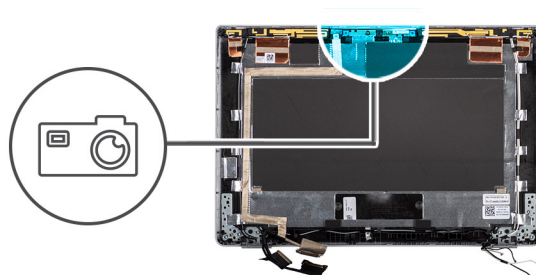

Steps

1. Insert the infrared camera into the slot on the display back cover.
2. Connect the infrared camera cable to the connector and adhere the adhesive tape above the camera connector.

Next steps

1. Install the [display panel](#).
2. Install the [display hinges](#).
3. Install the [display bezel](#).
4. Install the [display assembly](#).
5. Install the [battery](#).
6. Install the [base cover](#).
7. Follow the procedure in [after working inside your computer](#).

Smart card reader

Removing the smart card reader (optional)

Prerequisites

1. Follow the procedure in [before working inside your computer](#).
2. Remove the [base cover](#).
3. Remove the [battery](#).
4. Remove the [speakers](#).

About this task

 **NOTE:** For models with smart card reader configuration, the smart card reader is preinstalled in the replacement palm-rest assembly.

The following images indicate the location of the smart card reader and provide a visual representation of the removal procedure.



2x
M2x2.5

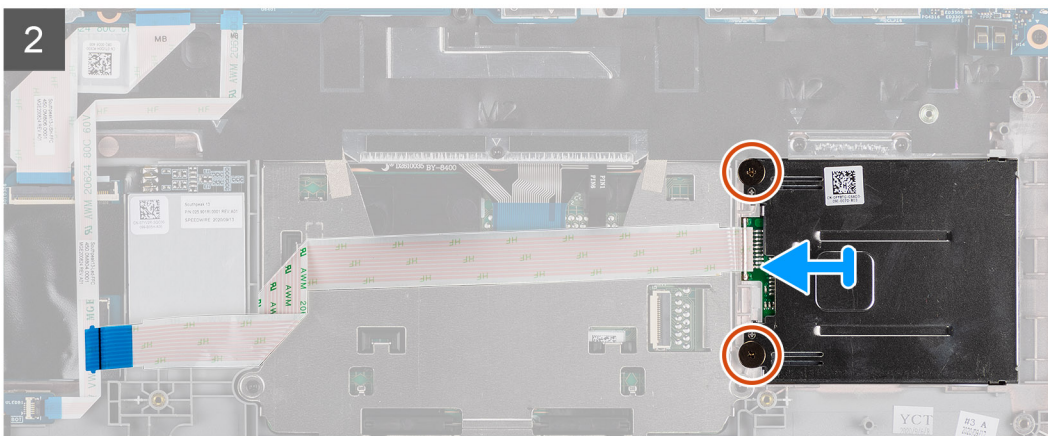
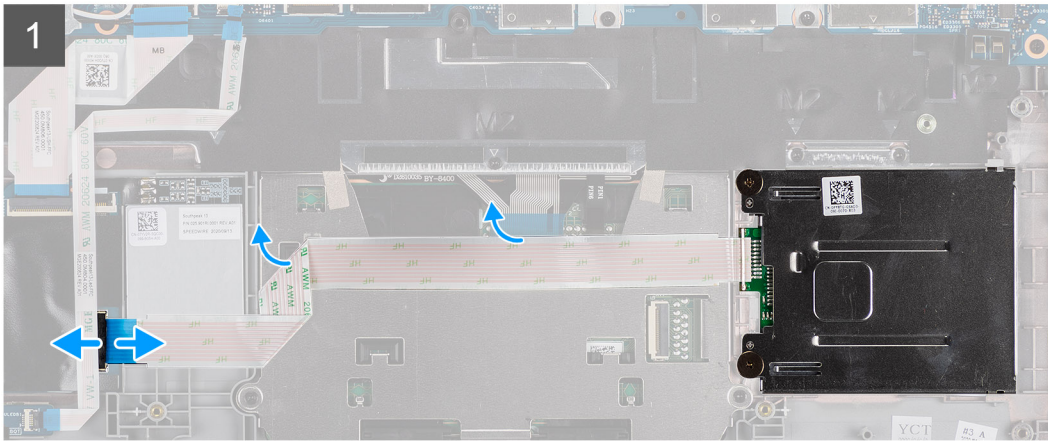
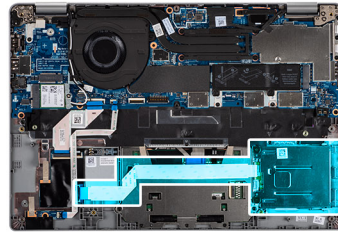

Steps

1. Open the latch and disconnect the clickpad FPC.
2. Open the latch and disconnect the smart card reader cable from its connector.
3. Remove the two screws (M2x2.5) that secure the smart card reader to the palm-rest assembly.
4. Lift the smart card reader off the palm-rest assembly.

Installing the smart card reader (optional)

Prerequisites

If you are replacing a component, remove the existing component before performing the installation procedure.

About this task

The following image indicates the location of the smart card reader and provides a visual representation of the installation



2x
M2x2.5

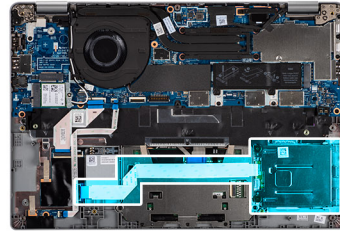

procedure.

Steps

1. Align and place the smart card reader on the palm-rest assembly.
2. Replace the two screws (M2x2.5) to secure the smart card reader to the palm-rest assembly.
3. Connect the smart card reader cable to its connector and close the latch.
4. Connect the clickpad FPC to its connector and close the latch.

Next steps

1. Install the [speakers](#).
2. Install the [battery](#).
3. Install the [base cover](#).
4. Follow the procedure in [after working inside your computer](#).

Keyboard

Removing the keyboard

Prerequisites

1. Follow the procedure in [before working inside your computer](#).
2. Remove the [base cover](#).
3. Remove the [WLAN card](#).
4. Remove the [WWAN card](#) (optional).
5. Remove the [M.2 2280 SSD](#) or [M.2 2230 SSD](#).
6. Remove the [battery](#).
7. Remove the [fan](#).
8. Remove the [heat sink](#).
9. Remove the [system board](#).
10. Remove the [power button with fingerprint reader](#).
11. Remove the [smart card reader](#) (optional).
12. Remove the [speakers](#).
13. Remove the [display assembly](#).

About this task

 **NOTE:** The system board can be removed with the heat sink attached in order to simplify the procedure and preserve the thermal bond between the system board and heat sink.

The following images indicate the location of the keyboard and provide a visual representation of the removal procedure.



16x
M2x2

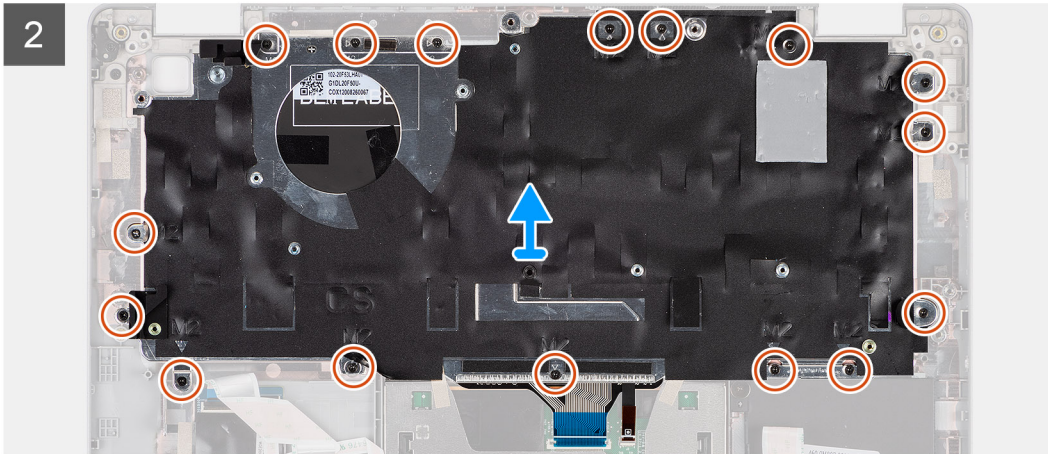
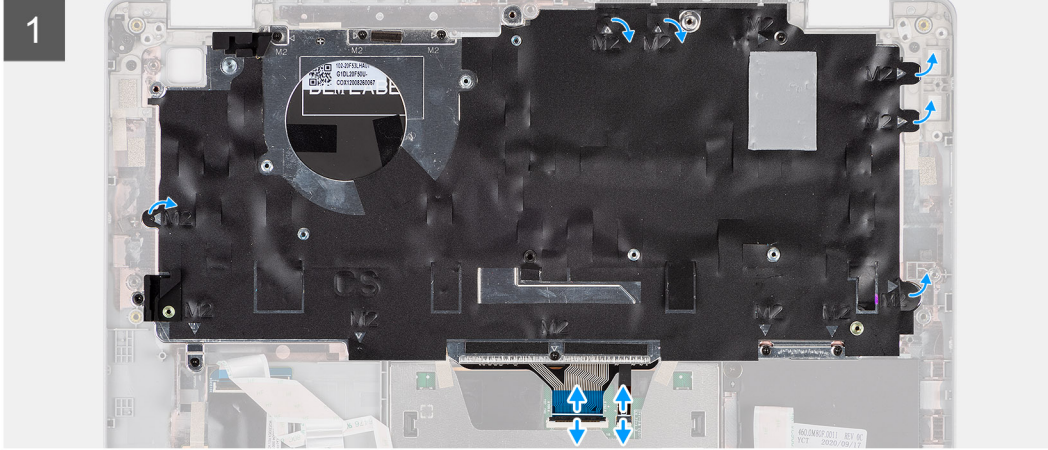
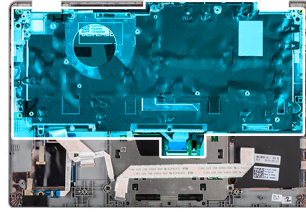



3x
M2x2



Steps

1. Lift the latch and disconnect the keyboard cable and keyboard backlit cable.
2. Lift the mylar tape covering the screws.
3. Remove the sixteen (M2x2) screws that secure the keyboard assembly to the palm-rest.
4. Carefully lift the keyboard assembly from the palm-rest.
5. Flip the keyboard assembly.
6. Remove the three (M2x2) screws that secure the keyboard to the keyboard bracket.
7. Remove the keyboard from the keyboard bracket.

Installing the keyboard

Prerequisites

If you are replacing a component, remove the existing component before performing the installation procedure.

About this task

NOTE: The system board can be installed with the heat sink attached in order to simplify the procedure and preserve the thermal bond between the system board and heat sink.

The following image indicates the location of the keyboard and provides a visual representation of the installation procedure.



3x
M2x2





16x
M2x2

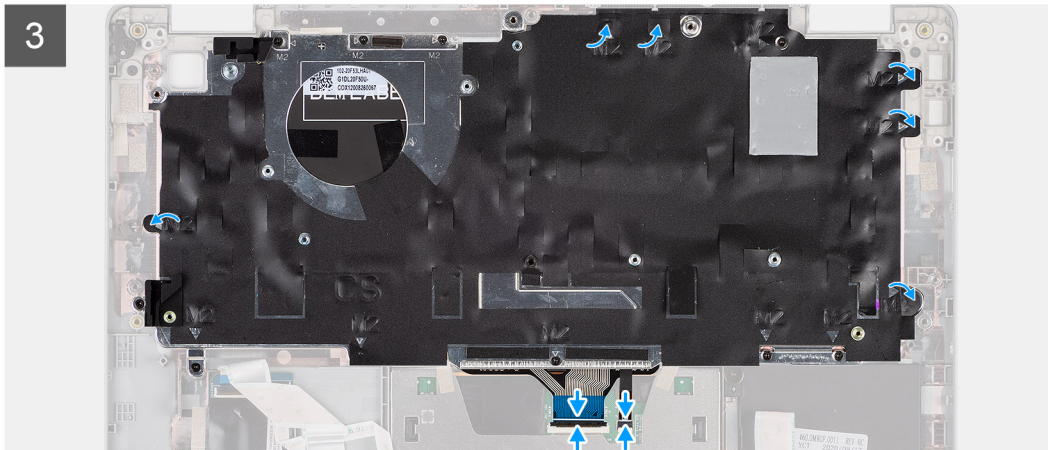
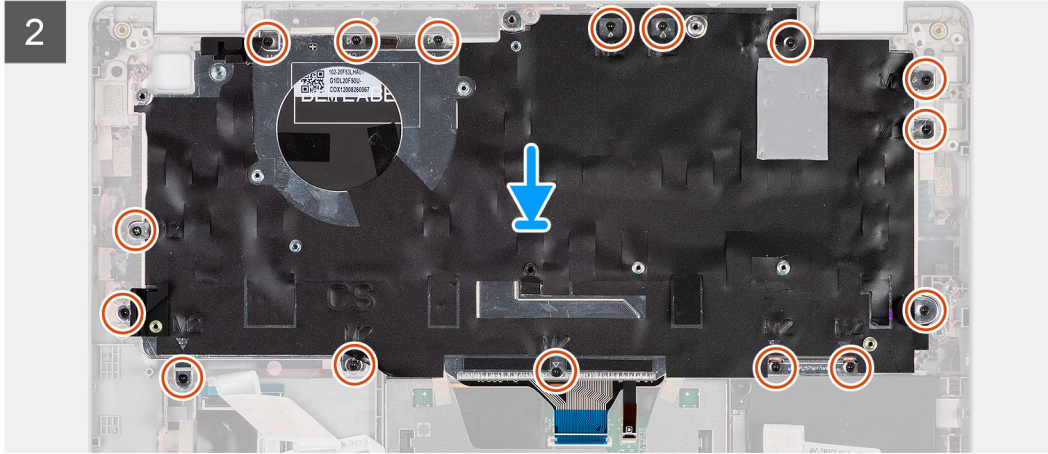
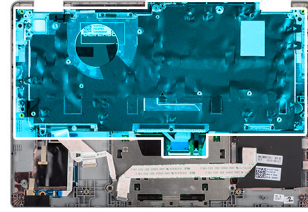

Steps

1. Replace the three (M2x2) screws to secure the keyboard to the keyboard bracket.
2. Flip the keyboard assembly and align it to its slot on the palm-rest.
3. Press down on the lattice at the snap points, in order to secure the keyboard assembly to the palm-rest.
4. Replace the sixteen (M2x2) screws that secure the keyboard assembly to the palm-rest.
5. Connect the keyboard cable and keyboard backlit cable to its connectors.

Next steps

1. Install the [display assembly](#).
2. Install the [speakers](#).
3. Install the [smart card reader \(optional\)](#).
4. Install the [power button with fingerprint reader](#).
5. Install the [system board](#).
6. Install the [heat sink](#).
7. Install the [fan](#).
8. Install the [battery](#).
9. Install the [M.2 2280 SSD card](#) or [M.2 2230 SSD card](#).
10. Install the [WWAN card](#) (optional).
11. Install the [WLAN card](#).

12. Install the [base cover](#).
13. Follow the procedure in [after working inside your computer](#).

SIM card slot filler

Removing the SIM card slot filler

Prerequisites

Follow the procedure in [before working inside your computer](#).

About this task

NOTE: For models shipped with WLAN antennas only, the SIM card slot filler is a separate service part and is not included with replacement palm rest, as a result the SIM card slot filler must be removed and then re-installed when replacing the palm rest.

The following image provides a visual representation of the SIM card slot filler removal procedure.

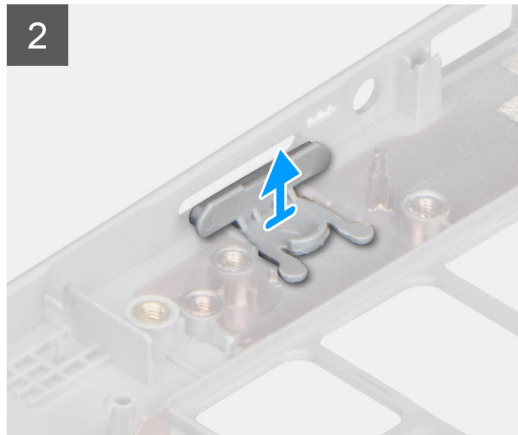
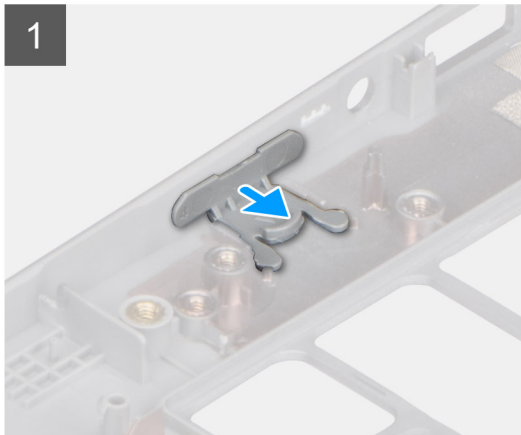
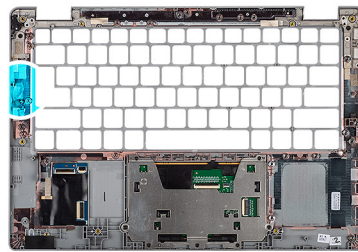

Steps

1. Pull the SIM card slot filler from the top side of the palm rest.
2. Lift the SIM card slot filler out of the system.

Installing the SIM card slot filler

Prerequisites

If you are replacing a component, remove the necessary component before the installation procedure.

About this task

The following image provides a visual representation of the SIM card slot filler installation procedure.

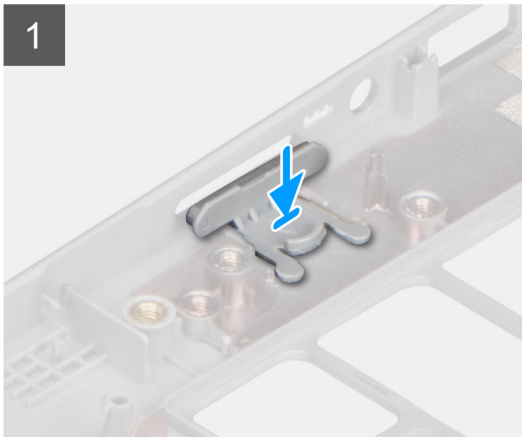
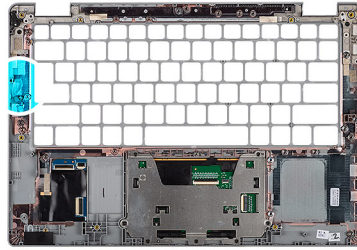

Steps

1. Place the SIM card slot filler into its compartment on the palm rest ensuring that the SIM card slot filler is aligned with the ribs on the palm rest.
2. Press the SIM card slot filler until you hear it click ensuring it fits securely into the SIM card slot filler.

Next steps

Follow the procedure in [After working on your computer](#).

Palm-rest and keyboard assembly

Removing the palmrest

Prerequisites

NOTE: The system board can be removed with the heat sink attached in order to simplify the procedure and preserve the thermal bond between the system board and heat sink.

NOTE: For models with smart card reader configuration, the smart card reader is preinstalled in the replacement palm-rest assembly.

1. Follow the procedure in [before working inside your computer](#).
2. Remove the [SIM card](#).
3. Remove the [microSD card](#).
4. Remove the [base cover](#).
5. Remove the [battery](#).
6. Remove the [WLAN card](#).
7. Remove the [WWAN card](#) (optional).
8. Remove the [SIM card slot filler](#) (for non-WWAN configuration).
9. Remove the [M.2 2280 SSD](#) or [M.2 2230 SSD](#).
10. Remove the [fan](#).
11. Remove the [smart card reader](#) (optional).
12. Remove the [speakers](#).

13. Remove the [heat sink](#).
14. Remove the [power button with fingerprint reader](#).
15. Remove the [display assembly](#).
16. Remove the [system board](#).

About this task

The following images indicate the location of the palm-rest and provide a visual representation of the removal procedure.

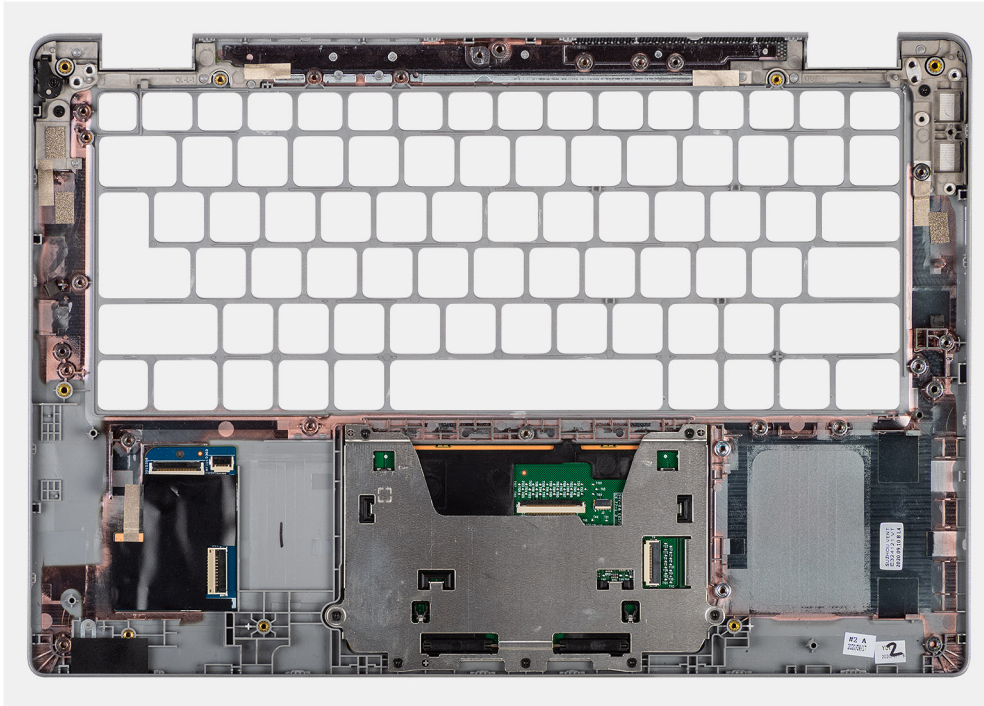

Steps

Installing the palm-rest

Prerequisites

If you are replacing a component, remove the existing component before performing the installation procedure.

About this task

The following image indicates the palm-rest and provides a visual representation of the installation procedure.

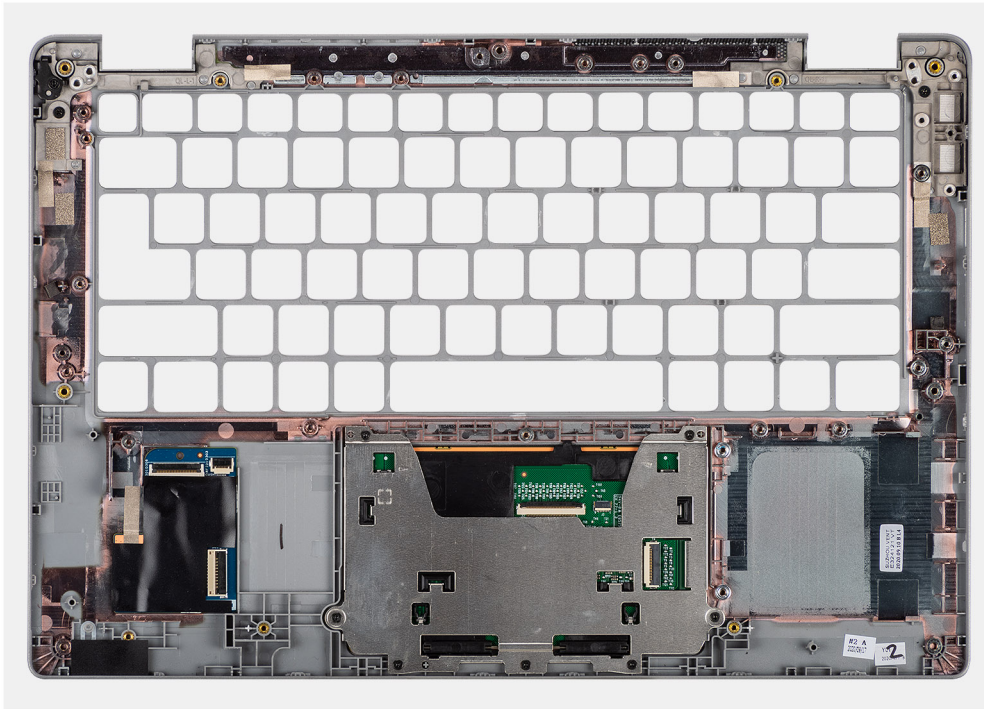

Steps

Place the palm-rest and keyboard assembly on a flat surface.

Next steps

i **NOTE:** The system board can be installed with the heat sink attached in order to simplify the procedure and preserve the thermal bond between the system board and heat sink.

1. Install the [system board](#).
2. Install the [display assembly](#).
3. Install the [power button with fingerprint reader \(optional\)](#).
4. Install the [heat sink](#).
5. Install the [speakers](#).
6. Install the [smart card reader \(optional\)](#).
7. Install the [fan](#).
8. Install the [M.2 2280 SSD card](#) or [M.2 2230 SSD card](#).
9. Install the [WWAN card](#) (optional).
10. Install the [SIM card slot filler](#) (for non-WWAN configuration).
11. Install the [WLAN card](#).
12. Install the [battery](#).
13. Install the [base cover](#).
14. Follow the procedure in [after working inside your computer](#).

Drivers and downloads

When troubleshooting, downloading, or installing drivers, it is recommended that you read the Dell knowledge base article, [Drivers and Downloads FAQs](#) .

BIOS setup

CAUTION: Unless you are an expert computer user, do not change the settings in the BIOS Setup program. Certain changes can make your computer work incorrectly.

NOTE: Depending on the computer and its installed devices, the items listed in this section may or may not be displayed.

NOTE: Before you change BIOS Setup program, it is recommended that you write down the BIOS Setup program screen information for future reference.

Use the BIOS Setup program for the following purposes:

- Get information about the hardware installed in your computer, such as the amount of RAM and the size of the hard drive.
- Change the system configuration information.
- Set or change a user-selectable option, such as the user password, type of hard drive installed, and enabling or disabling base devices.

Topics:

- [BIOS overview](#)
- [Entering BIOS setup program](#)
- [Navigation keys](#)
- [One time boot menu](#)
- [BIOS setup](#)
- [Updating the BIOS](#)
- [System and setup password](#)
- [Clearing BIOS \(System Setup\) and System passwords](#)

BIOS overview

The BIOS manages data flow between the computer's operating system and attached devices such as hard disk, video adapter, keyboard, mouse, and printer.

Entering BIOS setup program

Steps

1. Turn on your computer.
2. Press F2 immediately to enter the BIOS setup program.

NOTE: If you wait too long and the operating system logo appears, continue to wait until you see the desktop. Then, turn off your computer and try again.

Navigation keys

NOTE: For most of the System Setup options, changes that you make are recorded but do not take effect until you restart the system.

Table 2. Navigation keys

Keys	Navigation
Up arrow	Moves to the previous field.
Down arrow	Moves to the next field.
Enter	Selects a value in the selected field (if applicable) or follow the link in the field.
Spacebar	Expands or collapses a drop-down list, if applicable.
Tab	Moves to the next focus area.  NOTE: For the standard graphics browser only.
Esc	Moves to the previous page until you view the main screen. Pressing Esc in the main screen displays a message that prompts you to save any unsaved changes and restarts the system.

One time boot menu

To enter **one time boot menu**, turn on your computer, and then press F12 immediately.

 **NOTE:** It is recommended to shutdown the computer if it is on.

The one-time boot menu displays the devices that you can boot from including the diagnostic option. The boot menu options are:

- Removable Drive (if available)
- STXXXX Drive (if available)
 **NOTE:** XXX denotes the SATA drive number.
- Optical Drive (if available)
- SATA Hard Drive (if available)
- Diagnostics

The boot sequence screen also displays the option to access the System Setup screen.

BIOS setup

 **NOTE:** Depending on the laptop and its installed devices, the items listed in this section may or may not appear.

Overview

Table 3. Overview

Option	Description
System Information	This section lists the primary hardware features on your system. The options are: <ul style="list-style-type: none">• System Information<ul style="list-style-type: none">○ BIOS version○ Service Tag○ Asset Tag○ Manufacture Date○ Ownership Date○ Express Service Code

Table 3. Overview

Option	Description
	<ul style="list-style-type: none"> ○ Ownership Tag ○ Signed Firmware Update ● Battery <ul style="list-style-type: none"> ○ Primary ○ Battery Level ○ Battery State ○ Health ○ AC Adapter ● Processor Information <ul style="list-style-type: none"> ○ Processor Type ○ Maximum Clock Speed ○ Minimum Clock Speed ○ Current Clock Speed ○ Core Count ○ Processor ID ○ Processor L2 Cache ○ Processor L3 Cache ○ Microcode Version ○ Intel Hyper-Threading Capable ○ 64-Bit Technology ● Memory Configuration <ul style="list-style-type: none"> ○ Memory Installed ○ Memory Available ○ Memory Speed ○ Memory Channel Mode ○ Memory Technology ● Device Information <ul style="list-style-type: none"> ○ Panel Type ○ Privacy Screen ○ Video Controller ○ Video Memory ○ Wi-Fi Device ○ Native Resolution ○ Video BIOS Version ○ Audio Controller ○ Bluetooth Device ○ Pass Through MAC Address ○ Cellular Device

Boot configuration

Table 4. Boot configuration

Option	Description
Boot Sequence	<p>Allows you to set the order in which the BIOS searches devices to find an operating system to boot.</p> <p>The options are:</p> <ul style="list-style-type: none"> ● Windows Boot Manager ● UEFI RST <p> NOTE: Legacy Boot mode is not supported on this platform.</p>

Table 4. Boot configuration (continued)

Option	Description
Secure Digital (SD) Card Boot	Allows you to enable or disable Enable Secure Digital (SD) Card Boot .
Secure Boot	Secure Boot helps ensure your system boots using only validated boot software. Enable Secure Boot —By default, this option is enabled.
Secure Boot Mode	Changes to the Secure Boot operation mode modifies the behavior of Secure Boot to allow evaluation of UEFI driver signatures. The options are: <ul style="list-style-type: none"> • Deployed Mode—By default, this option is enabled. • Audit Mode
Expert Key Management	Allows you to enable or disable Expert Key Management. Enable Custom Mode —By default, this option is disabled. The Custom Mode Key Management options are: <ul style="list-style-type: none"> • PK—By default, this option is enabled. • KEK • db • dbx

Integrated Devices

Table 5. Integrated device options

Option	Description
Date/Time	Allows you to set the date and time. The change to the system date and time takes effect immediately.
Camera	Allows you to enable or disable camera. Enable Camera - This option is enabled by default.
Audio	Allows you to turn off all integrated audio. By default, the Enable Audio option is selected. Allows you to enable or disable the integrated audio or microphone and speaker separately. By default, the Enable Audio option is selected. The options are: <ul style="list-style-type: none"> • Enable Microphone • Enable Internal Speaker
USB/Thunderbolt Configuration	Allows you to enable or disable the USB mass storage devices to boot through the boot sequence or boot menu. The options are: <ul style="list-style-type: none"> • Enable External USB Port - This option is enabled by default. • Enable USB Boot Support - This option is enabled by default. By default, all the options are enabled.

Table 5. Integrated device options (continued)

Option	Description
Enable Thunderbolt Technology Support	Allows you to enable or disable the Thunderbolt Technology. Enable Thunderbolt Technology Support - This option is enabled by default.
Enable Thunderbolt Boot Support	Allows you to enable or disable the Thunderbolt adapter features during preboot. Enable Thunderbolt Boot Support - This option is disabled by default.
Enable Thunderbolt (and PCIe behind TBT) pre-boot modules	Allows you to enable or disable the PCIe devices that are connected through Thunderbolt adapter features to run the PCIe device's UEFI Option ROMs if present during preboot. Enable Thunderbolt (and PCIe behind TBT) pre-boot modules - This option is disabled by default.
Disable USB4 PCIe Tunneling	By default the Disable USB4 PCIe Tunneling is disabled.
Video/Power only on Type-C Ports	This feature limits Type-C port functionality to video or power only. Video/Power only on Type-C Ports - This option is disabled by default. i NOTE: Enabling the Enable Thunderbolt Adapter Boot Support or Enable Thunderbolt Adapter Pre-Boot Modules option may allow devices that are connected to Thunderbolt adapter during preboot to function in the operating system regardless of the security level selected in BIOS setup. The device continues to operate in the operating system until it is disconnected. When connected while within the operating system, the device connects according to the security level and previous operating system authorizations.
Type-C Dock Override	This feature allows the users to use connected Type-C Dell Dock to provide data stream when keeping the external USB ports disabled port functionality to video or power only. Type-C Dock Override - This option is enabled by default. The submenu is: Video Allows users to use video on Dell Dock external ports. Audio Allows users to use audio on Dell Dock external ports. LAN Allows users to use LAN on Dell Dock external ports. Audio and LAN - These options are enabled by default.
Miscellaneous Drives	Enable Fingerprint Reader Device - Allows you to enable or disable the fingerprint reader device. This option is enabled by default.
Unobstrusive Mode	Enable Unobstrusive Mode - - Allows you to turn off the system light and sound. This option is set to Off by default.

Storage

Table 6. Storage options

Option	Description
SATA/NVMe Operation	Allows you to set the operating mode of the integrated storage device controller. The options are: <ul style="list-style-type: none"> • Disabled • AHCI/NVMe • RAID On— By default, the RAID On option is enabled.
Storage Interface	Port Enablement - Allows you to select onboard drives. The options are: <ul style="list-style-type: none"> • SATA-1 — By default, the RAID On option is enabled. • M.2 PCIe SSD — By default, the RAID On option is enabled. By default, all the options are enabled.
SMART Reporting	This field controls whether hard drive errors for integrated drives are reported during system startup. This technology is part of the Self Monitoring Analysis and Reporting Technology (SMART) specification. By default, the Enable SMART Reporting option is disabled .
Drive Information	Provides information about drive type and device.
Enable MediaCard	Allows you to switch all media cards On/Off or enable/disable the media card in read-only state. Secure Digital (SD) Card - This option is enabled by default. Secure Digital (SD) Card Read-Only Mode

Display

Table 7. Display options

Option	Description
Display Brightness	Allows you to set the screen brightness when running on battery and AC power. The options are: <ul style="list-style-type: none"> • Brightness on battery power - By default, set to 50. • Brightness on AC power - By default, set to 100.
Touchscreen	Allows you to enable or disable the touchscreen for the operating system. NOTE: Touchscreen always works in the BIOS setup irrespective of this setting. Touchscreen - By default, this option is enabled.
Full Screen Logo	Displays full screen logo when the image matches screen resolution. By default, this option is disabled.
Privacy Screen	Allows you to set the operating mode of the Privacy Screen.

Table 7. Display options (continued)

Option	Description
	<p>The options are:</p> <ul style="list-style-type: none"> • Disabled • Enabled - By default, this option is enabled. • Always On

Connection options

Table 8. Connection

Option	Description
Wireless Device Enable	<p>WWAN/GPS Allows you to enable or disable the internal WWAN/GPS device.</p> <p>WWAN Bus Mode - Allows you to set the interface type of the wireless WAN card.</p> <p>The options are:</p> <p>Bus Mode PCIe - This option is recommended for Microsoft Windows users.</p> <p>Bus Mode USB</p> <p>WLAN Allows you to enable or disable the internal WLAN device.</p> <p>Bluetooth Allows you to enable or disable the internal Bluetooth device.</p> <p>Contactless smartcard/NFC Allows you to enable or disable the internal Near Field Computing device.</p>
Enable UEFI Network Stack	<p>It allows pre-OS and early operating system networking features to use any enabled NICs when UEFI networking protocols are installed and available. This can be used without PXE turned on.</p> <p>Enable UEFI Network Stack - This option is enabled by default.</p>
Wireless Radio Control	<p>This feature senses the connection of the system to a wired network and disables the selected wireless radios (WLAN and/or WWAN).</p> <p>The options are:</p> <ul style="list-style-type: none"> • Control WLAN radio - This option is disabled by default. • Control WWAN radio - This option is disabled by default. <p>NOTE: Checking Control WLAN radio can result in loss of dock connectivity when the system is docked over WiGig while also connected over a wired network.</p>
HTTPs Boot Failure	<p>Allows you to enable or disable HTTPs Boot feature.</p> <p>HTTPs Boot - This option is enabled by default.</p>

Power management

Table 9. Power Management

Option	Description
Battery Configuration	<p>Allows the system to run on battery during peak power usage hours.</p> <p>The options are:</p> <ul style="list-style-type: none"> • Adaptive—This option is enabled by default.

Table 9. Power Management (continued)

Option	Description
	<ul style="list-style-type: none"> ● Standard ● ExpressCharge ● Primarily AC Use ● Custom <p>i NOTE: If Custom Charge is selected, you can also configure Custom Charge Start and Custom Charge Stop.</p>
Advanced Configuration	<p>This option enables you to maximize the battery health.</p> <p>By default, the Enable Advanced Battery Charge Mode option is disabled.</p> <p>i NOTE: The user can charge battery using feature Beginning of Day and Work Period.</p> <p>By default, Work Period is disabled.</p> <p>Use ExpressCharge for accelerated battery charging.</p>
Peak Shift	<p>Allows the system to run on battery during peak power usage hours.</p> <p>Peak Shift - By default, this option is disabled.</p> <p>i NOTE: The user can:</p> <ul style="list-style-type: none"> ● Set Battery Threshold Min = 15, Max = 100 ● Prevent AC power between certain times of the day using Peak Shift Start, Peak Shift End, and Peak Shift Charge Start.
USB PowerShare	<p>Allows external devices such as phones and portable music players to be charged when the system is in sleep state using system stored battery.</p> <p>Enable USB PowerShare-This option is disabled by default.</p>
Thermal Management	<p>Allows cooling of fans and the processor heat management to adjust system performance, noise, and temperature.</p> <p>The options are:</p> <ul style="list-style-type: none"> ● Optimized—This option is enabled by default. ● Cool ● Quiet ● Ultra Performance
USB Wake Support	<p>Wake on Dell USB-C Dock Allows you to connect a Dell USB-C Dock to wake the system from standby mode.</p> <p>By default, the option Wake on Dell USB-C Dock is enabled.</p> <p>i NOTE: These features are only functional when the AC power adapter is connected. If the AC power adapter is removed before Standby, the BIOS removes power from all USB ports to conserve battery power.</p>
Block Sleep	<p>This option enables you to block entering to sleep (S3) mode in operating system environment. By default, the Block Sleep option is disabled.</p> <p>i NOTE: When Block Sleep is enabled, the system does not go to sleep. Intel Rapid Start gets disabled automatically, and the operating system power option remains blank if it was set to Sleep.</p>
Lid Switch	<p>Allows you to disable the lid switch.</p> <p>The options are:</p> <ul style="list-style-type: none"> ● Enable Lid Switch—This option is enabled by default.

Table 9. Power Management (continued)

Option	Description
Intel Speed Shift technology	Allows you to enable or disable the Intel Speed Shift Technology support. By default, Intel Speed Shift technology is enabled. Enabling this option allows the operating system to select appropriate processor performance.
Long Life Cycle Primary Battery	The options are: <ul style="list-style-type: none"> ● Normal battery—This option is enabled by default. ● LCL Gen1 Battery ● LCL Gen2 Battery

Security

Table 10. Security

Option	Description
TPM 2.0 Security	Allows you to enable or disable the Trusted Platform Module (TPM). The options are: <ul style="list-style-type: none"> ● TPM 2.0 Security On—This option is enabled by default. ● Attestation Enable—This option is enabled by default. ● Key Storage Enable—This option is enabled by default. ● SHA-256—This option is enabled by default. ● Clear ● PPI Bypass for Clear Command
Intel Total Memory Encryption	Total Memory Encryption - This option is disabled by default. It is used to protect memory from physical attacks including freeze spray and probing DDR to read the cycles. The system memory is encrypted by TME block attached to the memory controller.
Chassis Intrusion	Controls chassis intrusion feature. The options are: <ul style="list-style-type: none"> ● Disabled ● Enabled ● On-Silent—This option is enabled by default.
SMM Security Mitigation	Allows you to enable or disable additional UEFI SMM Security Mitigation protection. SMM Security Mitigation - By default, this option is enabled.
Data Wipe on Next Boot	Allows BIOS to queue up data wipe cycle for storage devices connected to the motherboard on the next reboot. Start Data Wipe - By default, this option is disabled.  NOTE: Secure Wipe operation deletes information in a way that it cannot be reconstructed.
Absolute	This field allows you to Enable, Disable, or Permanently Disable the BIOS module interface of the optional Absolute Persistence Module service from Absolute® Software. The options are: <ul style="list-style-type: none"> ● Enabled—This option is enabled by default. ● Disabled ● Permanently Disable Absolute
UEFI Boot Path Security	Controls whether the system prompts the user to enter the admin password (if set) when booting to a UEFI boot path device from the F12 boot menu.

Table 10. Security (continued)

Option	Description
	<p>The options are:</p> <ul style="list-style-type: none"> • Never • Always • Always Except Internal HDD—This option is enabled by default. • Always Except Internal HDD&PXE

Password

Table 11. Security



Option	Description
Admin Password	<p>Allows you to set, change, or delete the administrator (admin) password.</p> <p>The entries to set password are:</p> <ul style="list-style-type: none"> • Enter the old password: • Enter the new password: <p>Press Enter once you enter the new password and again press Enter to confirm the new password.</p> <p> NOTE: Deleting the admin password deletes the system password (if set). The admin password can also be used to delete hard drive password. For this reason, you cannot set an admin password if a system password or hard drive password is set. Hence, an admin password has to be set first if the admin password has to be used with system password and/or hard drive password.</p>
System Password	<p>Allows you to set, change, or delete the system password.</p> <p>The entries to set password are:</p> <ul style="list-style-type: none"> • Enter the old password: • Enter the new password: <p>Press Enter once you enter the new password and again press Enter to confirm the new password.</p>
NVMe SSD0	<p>Allows you to set, change, or delete the NVMe SSD0 password.</p> <p>The entries to set password are:</p> <ul style="list-style-type: none"> • Enter the old password: • Enter the new password: <p>Press Enter once you enter the new password and again press Enter to confirm the new password.</p>
Password Configuration	<p>Allows you to configure a password.</p> <p>Upper Case Letter When enabled, this field reinforces password must contain at least one upper capital letter.</p> <p>Lower Case Letter When enabled, this field reinforces password must contain at least one lower capital letter.</p> <p>Digit When enabled, this field reinforces password must contain at least one-digit number.</p> <p>Special Character When enabled, this field reinforces password must contain at least one special character.</p> <p> NOTE: These options by default are disabled.</p>

Table 11. Security (continued)

Option	Description
	<p>Minimum Characters Defines the number of characters allowed for a password. Min = 4</p>
Password Bypass	<p>Allows prompts for system and internal hard drive password, when powered on from Off state.</p> <p>The options are:</p> <ul style="list-style-type: none"> • Disabled—This option is enabled by default. • Reboot bypass
Password Changes	<p>Allows you to change the system password and hard drive password without the need of administrator password.</p> <p>Enable Non-Admin Password Changes - By default, this option is enabled.</p>
Admin Setup Lockout	<p>Allows the administrator to control how the user can access BIOS setup.</p> <p>Enable Admin Setup Lockout - By default, this option is disabled.</p> <p>NOTE:</p> <ul style="list-style-type: none"> • If the admin password is set and Enable Admin Setup Lockout is enabled, you cannot view the BIOS setup (using F2 or F12) without the admin password. • If the admin password is set and Enable Admin Setup Lockout is disabled, the BIOS setup can be entered and items that are viewed in Locked mode.
Master Password Lockout	<p>Allows you to disable master password support.</p> <p>Enable Master Password Lockout - By default, this option is disabled.</p> <p>NOTE: The Hard Disk password has to be cleared before the settings can be changed.</p>
Allow Non-Admin PSID Revert	<p>Controls access to the Physical Security ID (PSID) revert of NVMe hard drives from Dell Security Manager prompt.</p> <p>Enable Allow Non-Admin PSID Revert - By default, this option is disabled.</p>

Update and Recovery

Table 12. Update and recovery

Option	Description
UEFI Capsule Firmware Updates	<p>Allows you to update the system BIOS through UEFI capsule update packages.</p> <p>Enable UEFI Capsule Firmware Updates - By default, this option is enabled.</p> <p>NOTE: Disabling this option blocks BIOS updates from services such as Microsoft Windows update or Linux Vendor Firmware Services.</p>
BIOS Recovery from Hard Drive	<p>Allows you to recover BIOS on the primary hard drive or external USB drive in corrupted conditions.</p> <p>BIOS Recovery from Hard Drive - By default, this option is enabled.</p> <p>NOTE: BIOS Recovery from hard drives is not available for Self-Encrypting Drives (SED).</p>
BIOS Downgrade	<p>Allows you to control flashing of the system firmware to previous versions.</p> <p>Allow BIOS Downgrade - By default, this option is enabled.</p>
SupportAssist OS Recovery	<p>Allows you to enable or disable the boot flow for SupportAssist OS Recovery if there are certain system errors.</p>

Table 12. Update and recovery (continued)

Option	Description
	<p>SupportAssist OS Recovery - By default, this option is enabled.</p> <p> NOTE: If SupportAssist OS Recovery setup option is disabled, then all the automatic boot flow for SupportAssist OS Recovery tool is disabled.</p>
BIOSConnect	<p>Allows you to recover cloud service operating system if the main operating system and/or local service operating system fails to boot with the number of failures equal to or greater than the value specified by the Auto OS Recovery Threshold setup and local Service OS does not boot or is not installed.</p> <p>BIOSConnect - By default, this option is enabled.</p>
Dell Auto OS Recovery Threshold	<p>The Auto OS Recovery threshold setup options control the automatic flow for SupportAssist System Resolution Console and for Dell OS Recovery Tool.</p> <p>The options are:</p> <ul style="list-style-type: none"> ● Off ● 1 ● 2 - Default ● 3

System management

Table 13. System management

Option	Description
Service Tag	Displays the service tag of your system.
Asset Tag	An Asset Tag is a string of 64 characters that IT administrators use to uniquely identify a particular system. Once an asset tag is set, it cannot be changed.
AC Behavior	<p>Allows you to enable or disable the system from turning on automatically when an AC adapter is connected.</p> <p>Wake on AC - This option is disabled by default.</p>
Wake on LAN	<p>Allows the system to power on using special LAN signals.</p> <p>The options are:</p> <ul style="list-style-type: none"> ● Disabled - This option is enabled by default. ● LAN Only ● LAN with PXE Boot ●
Auto On Time	<p>This setting allows a system to automatically power on for defined days/time.</p> <p>The options are:</p> <ul style="list-style-type: none"> ● Disabled - This option is enabled by default. ● Every Day ● Weekdays ● Select Days

Keyboard

Table 14. Keyboard





Option	Description
Fn Lock Options	<p>Allows you to change the function key settings.</p> <p>Fn Lock Mode - This option is enabled by default.</p> <p>The options are:</p> <ul style="list-style-type: none"> ● Lock Mode Standard ● Lock Mode Secondary- This option is enabled by default.
Keyboard Illumination	<p>Allows you to set keyboard illumination settings using hotkeys <Fn>+<F10> during normal system operation.</p> <p>The options are:</p> <ul style="list-style-type: none"> ● Disabled ● Dim ● Bright- This option is enabled by default. <p> NOTE: The keyboard illumination brightness level can be set from 0% to 100%.</p>
Keyboard Backlight Timeout on AC	<p>This feature defines the timeout value for the keyboard backlight when an AC adapter is plugged in the system.</p> <p>The options are:</p> <ul style="list-style-type: none"> ● 5 seconds ● 10 seconds - This option is enabled by default. ● 15 seconds ● 30 seconds ● 1 minute ● 5 minutes ● 15 minutes ● Never <p> NOTE: If Never is selected, the backlight stays on always when the system has AC adapter plugged in.</p>
Keyboard Backlight Timeout on Battery	<p>This feature defines the timeout value for the keyboard backlight when the system is running only on battery power.</p> <p>The options are:</p> <ul style="list-style-type: none"> ● 5 seconds ● 10 seconds - This option is enabled by default. ● 15 seconds ● 30 seconds ● 1 minute ● 5 minutes ● 15 minutes ● Never <p> NOTE: If Never is selected, the backlight stays on always when the system is running on battery power.</p>
Device Configuration Hotkey Access	<p>This feature allows users to access device configuration screens using hotkeys during system startup. It prevents user access to Intel RAID (CTRL+I), LSI RAID (CTRL+C), or Intel Management Engine BIOS Extension (CTRL+P/F12).</p> <p>The options are:</p> <ul style="list-style-type: none"> ● Enabled - This option is enabled by default. ● One Time Enable

Table 14. Keyboard (continued)

Option	Description
	<ul style="list-style-type: none"> • Disabled

Pre-boot behavior

Table 15. Pre-boot behavior

Option	Description
Adapter Warnings	<p>This option displays warning messages during boot when adapters with little power capacity are detected.</p> <ul style="list-style-type: none"> • Enable Adapter Warnings—enabled by default
Warnings and Errors	<p>This option causes the boot process to only pause when warnings and errors are detected rather than stop, prompt, and wait for user input. This feature is useful where the system is being remotely managed.</p> <p>Select one of the following options:</p> <ul style="list-style-type: none"> • Prompt on Warnings and Errors—enabled by default • Continue on Warnings • Continue on Warnings and Errors <p> NOTE: Errors deemed critical to the operation of the system hardware always stop the system.</p>
Fastboot	<p>This option allows you to configure the speed of UEFI boot process.</p> <p>Select one of the following options:</p> <ul style="list-style-type: none"> • Minimal —enabled by default • Thorough • Auto
Extend BIOS POST Time	<p>This option allows you to configure the BIOS POST load time.</p> <p>Select one of the following options:</p> <ul style="list-style-type: none"> • 0 seconds—enabled by default. • 5 seconds • 10 seconds
MAC Address Pass-Through	<p>This allows you to choose a selected MAC address from the system to the external NIC MAC address (in a supported dock or dongle).</p> <p>The options are:</p> <ul style="list-style-type: none"> • System Unique MAC Address - enabled by default • Disabled

Virtualization support

Table 16. Virtualization Support

Option	Description
Intel Virtualization Technology	<p>This option specifies whether the system can run on a Virtual Machine Monitor (VMM).</p> <p>Enable Intel Virtualization Technology (VT) - This option is enabled by default.</p>
VT for Direct I/O	<p>This option specifies whether the system can perform Virtualization technology for direct I/O; an Intel method for virtualization for memory map I/O.</p>

Table 16. Virtualization Support (continued)

Option	Description
	Enable Intel VT for Direct I/O - This option is enabled by default.

Performance

Table 17. Performance

Option	Description
Multi Core Support	<p>Allows you to change the number of CPU cores available to the operating system. The default value is set to the maximum number of cores.</p> <ul style="list-style-type: none"> • All Cores — This option is enabled by default. • 1 • 2 • 3
Intel SpeedStep	<p>This feature allows the system to dynamically adjust processor voltage and core frequency, decreasing average power consumption and heat production.</p> <p>Enable Intel SpeedStep Technology - This option is enabled by default.</p>
C-States Control	<p>This feature allows you to enable or disable the ability of the CPU to enter and exit low-power states.</p> <p>Enable C-state control - This option is enabled by default.</p>
Intel Turbo Boost Technology	<p>This option allows you to enable or disable the Intel TurboBoost mode of the processor.</p> <p>Enable Intel Turbo Boost Technology - This option is enabled by default.</p>
Intel Hyper-Threading Technology	<p>This option allows you to enable or disable the HyperThreading in the processor.</p> <p>Enable Intel Hyper-Threading Technology - This option is enabled by default.</p>

System logs

Table 18. System Logs

Option	Description
BIOS Event Log	<p>Allows you to either keep and clear the BIOS event log.</p> <p>Clear BIOS Event Log</p> <p>The options are:</p> <ul style="list-style-type: none"> • Keep - This option is enabled by default. • Clear
Thermal Event Log	<p>Allows you to either keep and clear the Thermal event log.</p> <p>Clear Thermal Event Log</p> <p>The options are:</p>

Table 18. System Logs (continued)

Option	Description
	<ul style="list-style-type: none"> ● Keep - This option is enabled by default. ● Clear
Power Event Log	<p>Allows you to either keep and clear the Power event log.</p> <p>Clear Power Event Log</p> <p>The options are:</p> <ul style="list-style-type: none"> ● Keep - This option is enabled by default. ● Clear

Updating the BIOS

Updating the BIOS in Windows

About this task

CAUTION: If BitLocker is not suspended before updating the BIOS, the next time you reboot the system it will not recognize the BitLocker key. You will then be prompted to enter the recovery key to progress and the system will ask for this on each reboot. If the recovery key is not known this can result in data loss or an unnecessary operating system re-install. For more information on this subject, see Knowledge Article: <https://www.dell.com/support/article/sln153694>

Steps

1. Go to www.dell.com/support.
2. Click **Product support**. In the **Search support** box, enter the Service Tag of your computer, and then click **Search**.

NOTE: If you do not have the Service Tag, use the SupportAssist feature to automatically identify your computer. You can also use the product ID or manually browse for your computer model.
3. Click **Drivers & Downloads**. Expand **Find drivers**.
4. Select the operating system installed on your computer.
5. In the **Category** drop-down list, select **BIOS**.
6. Select the latest version of BIOS, and click **Download** to download the BIOS file for your computer.
7. After the download is complete, browse the folder where you saved the BIOS update file.
8. Double-click the BIOS update file icon and follow the on-screen instructions.

For more information, see knowledge base article [000124211](https://www.dell.com/support/article/000124211) at www.dell.com/support.

Updating the BIOS in Linux and Ubuntu

To update the system BIOS on a computer that is installed with Linux or Ubuntu, see the knowledge base article [000131486](https://www.dell.com/support/article/000131486) at www.dell.com/support.

Updating the BIOS using the USB drive in Windows

About this task

CAUTION: If BitLocker is not suspended before updating the BIOS, the next time you reboot the system it will not recognize the BitLocker key. You will then be prompted to enter the recovery key to progress and the system will ask for this on each reboot. If the recovery key is not known this can result in data loss or an

unnecessary operating system re-install. For more information on this subject, see Knowledge Article: <https://www.dell.com/support/article/sln153694>

Steps

1. Follow the procedure from step 1 to step 6 in [Updating the BIOS in Windows](#) to download the latest BIOS setup program file.
2. Create a bootable USB drive. For more information, see the knowledge base article [000145519](#) at www.dell.com/support.
3. Copy the BIOS setup program file to the bootable USB drive.
4. Connect the bootable USB drive to the computer that needs the BIOS update.
5. Restart the computer and press **F12**.
6. Select the USB drive from the **One Time Boot Menu**.
7. Type the BIOS setup program filename and press **Enter**.
The **BIOS Update Utility** appears.
8. Follow the on-screen instructions to complete the BIOS update.

Updating the BIOS from the F12 One-Time boot menu

Update your computer BIOS using the BIOS update.exe file that is copied to a FAT32 USB drive and booting from the F12 One-Time boot menu.

About this task

 **CAUTION:** If BitLocker is not suspended before updating the BIOS, the next time you reboot the system it will not recognize the BitLocker key. You will then be prompted to enter the recovery key to progress and the system will ask for this on each reboot. If the recovery key is not known this can result in data loss or an unnecessary operating system re-install. For more information on this subject, see Knowledge Article: <https://www.dell.com/support/article/sln153694>

BIOS Update

You can run the BIOS update file from Windows using a bootable USB drive or you can also update the BIOS from the F12 One-Time boot menu on the computer.

Most of the Dell computers built after 2012 have this capability, and you can confirm by booting your computer to the F12 One-Time Boot Menu to see if BIOS FLASH UPDATE is listed as a boot option for your computer. If the option is listed, then the BIOS supports this BIOS update option.

 **NOTE:** Only computers with BIOS Flash Update option in the F12 One-Time boot menu can use this function.

Updating from the One-Time boot menu

To update your BIOS from the F12 One-Time boot menu, you need the following:

- USB drive formatted to the FAT32 file system (key does not have to be bootable)
- BIOS executable file that you downloaded from the Dell Support website and copied to the root of the USB drive
- AC power adapter that is connected to the computer
- Functional computer battery to flash the BIOS

Perform the following steps to perform the BIOS update flash process from the F12 menu:

 **CAUTION:** Do not turn off the computer during the BIOS update process. The computer may not boot if you turn off your computer.

Steps

1. From a turn off state, insert the USB drive where you copied the flash into a USB port of the computer.
2. Turn on the computer and press F12 to access the One-Time Boot Menu, select BIOS Update using the mouse or arrow keys then press Enter.
The flash BIOS menu is displayed.
3. Click **Flash from file**.
4. Select external USB device.
5. Select the file and double-click the flash target file, and then click **Submit**.

6. Click **Update BIOS**. The computer restarts to flash the BIOS.
7. The computer will restart after the BIOS update is completed.

System and setup password

Table 19. System and setup password

Password type	Description
System password	Password that you must enter to log in to your system.
Setup password	Password that you must enter to access and make changes to the BIOS settings of your computer.

You can create a system password and a setup password to secure your computer.

 **CAUTION:** The password features provide a basic level of security for the data on your computer.

 **CAUTION:** Anyone can access the data that is stored on your computer if it is not locked and left unattended.

 **NOTE:** System and setup password feature is disabled.

Assigning a system setup password

Prerequisites

You can assign a new **System or Admin Password** only when the status is in **Not Set**.

About this task

To enter the system setup, press F12 immediately after a power-on or reboot.

Steps

1. In the **System BIOS** or **System Setup** screen, select **Security** and press Enter.
The **Security** screen is displayed.
2. Select **System/Admin Password** and create a password in the **Enter the new password** field.
Use the following guidelines to assign the system password:
 - A password can have up to 32 characters.
 - At least one special character: ! " # \$ % & ' () * + , - . / : ; < = > ? @ [\] ^ _ ` { | }
 - Numbers 0 through 9.
 - Upper case letters from A to Z.
 - Lower case letters from a to z.
3. Type the system password that you entered earlier in the **Confirm new password** field and click **OK**.
4. Press Esc and save the changes as prompted by the pop-up message.
5. Press Y to save the changes.
The computer restarts.

Deleting or changing an existing system setup password

Prerequisites

Ensure that the **Password Status** is Unlocked (in the System Setup) before attempting to delete or change the existing System and/or Setup password. You cannot delete or change an existing System or Setup password, if the **Password Status** is Locked.

About this task

To enter the System Setup, press F12 immediately after a power-on or reboot.

Steps

1. In the **System BIOS** or **System Setup** screen, select **System Security** and press Enter.
The **System Security** screen is displayed.
2. In the **System Security** screen, verify that **Password Status** is **Unlocked**.
3. Select **System Password**, update, or delete the existing system password, and press Enter or Tab.
4. Select **Setup Password**, update, or delete the existing setup password, and press Enter or Tab.
 **NOTE:** If you change the System and/or Setup password, reenter the new password when prompted. If you delete the System and/or Setup password, confirm the deletion when prompted.
5. Press Esc and a message prompts you to save the changes.
6. Press Y to save the changes and exit from System Setup.
The computer restarts.

Clearing BIOS (System Setup) and System passwords

About this task

To clear the system or BIOS passwords, contact Dell technical support as described at www.dell.com/contactdell.

-  **NOTE:** For information on how to reset Windows or application passwords, refer to the documentation accompanying Windows or your application.

Troubleshooting

Topics:

- [Handling swollen Lithium-ion batteries](#)
- [Dell SupportAssist Pre-boot System Performance Check diagnostics](#)
- [Built-in self-test \(BIST\)](#)
- [System diagnostic lights](#)
- [Recovering the operating system](#)
- [Real-Time Clock \(RTC Reset\)](#)
- [Updating the BIOS in Windows](#)
- [Updating the BIOS using the USB drive in Windows](#)
- [Backup media and recovery options](#)
- [WiFi power cycle](#)
- [Drain residual flea power \(perform hard reset\)](#)

Handling swollen Lithium-ion batteries

Like most laptops, Dell laptops use lithium-ion batteries. One type of lithium-ion battery is the lithium-ion polymer battery. Lithium-ion polymer batteries have increased in popularity in recent years and have become standard in the electronics industry due to customer preferences for a slim form factor (especially with newer ultra-thin laptops) and long battery life. Inherent to lithium-ion polymer battery technology is the potential for swelling of the battery cells.

Swollen battery may impact the performance of the laptop. To prevent possible further damage to the device enclosure or internal components leading to malfunction, discontinue the use of the laptop and discharge it by disconnecting the AC adapter and letting the battery drain.

Swollen batteries should not be used and should be replaced and disposed of properly. We recommend contacting Dell product support for options to replace a swollen battery under the terms of the applicable warranty or service contract, including options for replacement by a Dell authorized service technician.

The guidelines for handling and replacing Lithium-ion batteries are as follows:

- Exercise caution when handling Lithium-ion batteries.
- Discharge the battery before removing it from the system. To discharge the battery, unplug the AC adapter from the system and operate the system only on battery power. When the system will no longer power on when the power button is pressed, the battery is fully discharged.
- Do not crush, drop, mutilate, or penetrate the battery with foreign objects.
- Do not expose the battery to high temperatures, or disassemble battery packs and cells.
- Do not apply pressure to the surface of the battery.
- Do not bend the battery.
- Do not use tools of any type to pry on or against the battery.
- If a battery gets stuck in a device as a result of swelling, do not try to free it as puncturing, bending, or crushing a battery can be dangerous.
- Do not attempt to reassemble a damaged or swollen battery into a laptop.
- Swollen batteries that are covered under warranty should be returned to Dell in an approved shipping container (provided by Dell)—this is to comply with transportation regulations. Swollen batteries that are not covered under warranty should be disposed of at an approved recycling center. Contact Dell product support at <https://www.dell.com/support> for assistance and further instructions.
- Using a non-Dell or incompatible battery may increase the risk of fire or explosion. Replace the battery only with a compatible battery purchased from Dell that is designed to work with your Dell computer. Do not use a battery from other computers with your computer. Always purchase genuine batteries from <https://www.dell.com> or otherwise directly from Dell.

Lithium-ion batteries can swell for various reasons such as age, number of charge cycles, or exposure to high heat. For more information on how to improve the performance and lifespan of the laptop battery and to minimize the possibility of occurrence of the issue, see [Dell Laptop Battery - Frequently Asked Questions](#).

Dell SupportAssist Pre-boot System Performance Check diagnostics

About this task

SupportAssist diagnostics (also known as system diagnostics) performs a complete check of your hardware. The Dell SupportAssist Pre-boot System Performance Check diagnostics is embedded with the BIOS and is launched by the BIOS internally. The embedded system diagnostics provides a set of options for particular devices or device groups allowing you to:

- Run tests automatically or in an interactive mode
- Repeat tests
- Display or save test results
- Run thorough tests to introduce additional test options to provide extra information about the failed device(s)
- View status messages that inform you if tests are completed successfully
- View error messages that inform you of problems encountered during testing

 **NOTE:** Some tests for specific devices require user interaction. Always ensure that you are present at the computer terminal when the diagnostic tests are performed.

For more information, see <https://www.dell.com/support/kbdoc/000180971>.

Running the SupportAssist Pre-Boot System Performance Check

Steps

1. Turn on your computer.
2. As the computer boots, press the F12 key as the Dell logo appears.
3. On the boot menu screen, select the **Diagnostics** option.
4. Click the arrow at the bottom left corner. Diagnostics front page is displayed.
5. Click the arrow in the lower-right corner to go to the page listing. The items detected are listed.
6. To run a diagnostic test on a specific device, press Esc and click **Yes** to stop the diagnostic test.
7. Select the device from the left pane and click **Run Tests**.
8. If there are any issues, error codes are displayed. Note the error code and validation number and contact Dell.

Built-in self-test (BIST)

M-BIST

M-BIST (Built In Self-Test) is the system board's built-in self-test diagnostics tool that improves the diagnostics accuracy of system board embedded controller (EC) failures.

 **NOTE:** M-BIST can be manually initiated before POST (Power On Self Test).

How to run M-BIST

 **NOTE:** M-BIST must be initiated on the system from a power-off state either connected to AC power or with battery only.

1. Press and hold both the **M** key on the keyboard and the **power button** to initiate M-BIST.

2. With both the **M** key and the **power button** held down, the battery indicator LED may exhibit two states:
 - a. OFF: No fault detected with the system board
 - b. AMBER: Indicates a problem with the system board
3. If there is a failure with the system board, the battery status LED will flash one of the following error codes for 30 seconds:

Table 20. LED error codes

Blinking Pattern		Possible Problem
Amber	White	
2	1	CPU Failure
2	8	LCD Power Rail Failure
1	1	TPM Detection Failure
2	4	Unrecoverable SPI Failure

4. If there is no failure with the system board, the LCD will cycle through the solid color screens described in the LCD-BIST section for 30 seconds and then power off.

LCD Power rail test (L-BIST)

L-BIST is an enhancement to the single LED error code diagnostics and is automatically initiated during POST. L-BIST will check the LCD power rail. If there is no power being supplied to the LCD (i.e., the L-BIST circuit fails), the battery status LED will flash either an error code [2,8] or an error code [2,7].

 **NOTE:** If L-BIST fails, LCD-BIST cannot function as no power will be supplied to the LCD.

How to invoke L-BIST Test:

1. Press the power button to start the system.
2. If the system does not start up normally, look at the battery status LED:
 - If the battery status LED flashes an error code [2,7], the display cable may not be connected properly.
 - If the battery status LED flashes an error code [2,8], there is a failure on the LCD power rail of the system board, hence there is no power supplied to the LCD.
3. For cases, when a [2,7] error code is shown, check to see if the display cable is properly connected.
4. For cases when a [2,8] error code is shown, replace the system board.

LCD Built-in Self Test (BIST)

Dell laptops have a built-in diagnostic tool that helps you determine if the screen abnormality you are experiencing is an inherent problem with the LCD (screen) of the Dell laptop or with the video card (GPU) and PC settings.

When you notice screen abnormalities like flickering, distortion, clarity issues, fuzzy or blurry image, horizontal or vertical lines, color fade etc., it is always a good practice to isolate the LCD (screen) by running the Built-In Self Test (BIST).

How to invoke LCD BIST Test

1. Power off the Dell laptop.
2. Disconnect any peripherals that are connected to the laptop. Connect only the AC adapter (charger) to the laptop.
3. Ensure that the LCD (screen) is clean (no dust particles on the surface of the screen).
4. Press and hold **D** key and **Power on** the laptop to enter LCD built-in self test (BIST) mode. Continue to hold the D key, until the system boots up.
5. The screen will display solid colors and change colors on the entire screen to white, black, red, green, and blue twice.
6. Then it will display the colors white, black and red.
7. Carefully inspect the screen for abnormalities (any lines, fuzzy color or distortion on the screen).
8. At the end of the last solid color (red), the system will shut down.

NOTE: Dell SupportAssist Pre-boot diagnostics upon launch, initiates an LCD BIST first, expecting a user intervention confirm functionality of the LCD.

System diagnostic lights

Battery-status light

Indicates the power and battery-charge status.

Solid white — Power adapter is connected and the battery has more than 5 percent charge.

Amber — Computer is running on battery and the battery has less than 5 percent charge.

Off

- Power adapter is connected and the battery is fully charged.
- Computer is running on battery and the battery has more than 5 percent charge.
- Computer is in sleep state, hibernation, or turned off.

The power and battery-status light blinks amber along with beep codes indicating failures.

For example, the power and battery-status light blinks amber two times followed by a pause, and then blinks white three times followed by a pause. This 2,3 pattern continues until the computer is turned off indicating no memory or RAM is detected.

The following table shows different power and battery-status light patterns and associated problems.

Blinking Pattern		Problem description	Suggested resolution
1	1	TPM detection failure	Replace the system board.
1	2	Unrecoverable SPI flash failure	Replace the system board.
1	5	EC unable to program i-Fuse	Replace the system board.
1	6	Generic catch-all for ungraceful EC code flow errors	Disconnect all power source (AC, battery, coin cell) and drain flea power by pressing & holding down power button.
2	1	CPU failure	Run the Intel CPU diagnostics tools. If problem persists, replace the system board.
2	2	System Board failure (included BIOS corruption or ROM error)	Flash latest BIOS version. If problem persists, replace the system board.
2	3	No Memory / RAM detected	Confirm that the memory module is installed properly. If problem persists, replace the memory module.
2	4	Memory / RAM failure	Reset and swap memory modules amongst the slots. If problem persists, replace the memory module.
2	5	Invalid memory installed	Reset and swap memory modules amongst the slots. If problem persists, replace the memory module.
2	6	System board / Chipset Error	Replace the system board.
2	7	LCD failure (SBIOS message)	Replace the LCD module.
2	8	LCD failure (EC detection of power rail failure)	Replace the system board.

Blinking Pattern		Problem description	Suggested resolution
3	1	CMOS battery failure	Reset the CMOS battery connection. If problem persists, replace the RTC battery.
3	2	PCI or Video card/chip failure	Replace the system board.
3	3	BIOS recovery image not found	Flash latest BIOS version. If problem persists, replace the system board.
3	4	BIOS recovery image found but invalid	Flash latest BIOS version. If problem persists, replace the system board.
3	5	Power rail failure	Replace the system board.
3	6	Flash corruption detected by SBIOS.	Replace the system board.
3	7	Timeout waiting on ME to reply to HECI message.	Replace the system board.

Camera status light: Indicates whether the camera is in use.

- Solid white — Camera is in use.
- Off — Camera is not in use.

Caps Lock status light: Indicates whether Caps Lock is enabled or disabled.

- Solid white — Caps Lock enabled.
- Off — Caps Lock disabled.

Recovering the operating system

When your computer is unable to boot to the operating system even after repeated attempts, it automatically starts Dell SupportAssist OS Recovery.

Dell SupportAssist OS Recovery is a standalone tool that is preinstalled in all Dell computers installed with Windows operating system. It consists of tools to diagnose and troubleshoot issues that may occur before your computer boots to the operating system. It enables you to diagnose hardware issues, repair your computer, back up your files, or restore your computer to its factory state.

You can also download it from the Dell Support website to troubleshoot and fix your computer when it fails to boot into their primary operating system due to software or hardware failures.

For more information about the Dell SupportAssist OS Recovery, see *Dell SupportAssist OS Recovery User's Guide* at www.dell.com/serviceabilitytools. Click **SupportAssist** and then, click **SupportAssist OS Recovery**.

Real-Time Clock (RTC Reset)

The Real Time Clock (RTC) reset function allows you or the service technician to recover Dell Latitude systems from No POST/No Power/No Boot situations. The legacy jumper enabled RTC reset has been retired on these models.

Start the RTC reset with the system powered off and connected to AC power. Press and hold the power button for thirty (30) seconds. The system RTC Reset occurs after you release the power button.

Updating the BIOS in Windows

Steps

1. Go to www.dell.com/support.

2. Click **Product support**. In the **Search support** box, enter the Service Tag of your computer, and then click **Search**.

 **NOTE:** If you do not have the Service Tag, use the SupportAssist feature to automatically identify your computer. You can also use the product ID or manually browse for your computer model.

3. Click **Drivers & Downloads**. Expand **Find drivers**.
4. Select the operating system installed on your computer.
5. In the **Category** drop-down list, select **BIOS**.
6. Select the latest version of BIOS, and click **Download** to download the BIOS file for your computer.
7. After the download is complete, browse the folder where you saved the BIOS update file.
8. Double-click the BIOS update file icon and follow the on-screen instructions.

For more information, see knowledge base article [000124211](https://www.dell.com/support/000124211) at www.dell.com/support.

Updating the BIOS using the USB drive in Windows

Steps

1. Follow the procedure from step 1 to step 6 in [Updating the BIOS in Windows](#) to download the latest BIOS setup program file.
2. Create a bootable USB drive. For more information, see the knowledge base article [000145519](https://www.dell.com/support/000145519) at www.dell.com/support.
3. Copy the BIOS setup program file to the bootable USB drive.
4. Connect the bootable USB drive to the computer that needs the BIOS update.
5. Restart the computer and press **F12**.
6. Select the USB drive from the **One Time Boot Menu**.
7. Type the BIOS setup program filename and press **Enter**.
The **BIOS Update Utility** appears.
8. Follow the on-screen instructions to complete the BIOS update.

Backup media and recovery options

It is recommended to create a recovery drive to troubleshoot and fix problems that may occur with Windows. Dell proposes multiple options for recovering Windows operating system on your Dell PC. For more information, see [Dell Windows Backup Media and Recovery Options](#).

WiFi power cycle

About this task

If your computer is unable to access the internet due to WiFi connectivity issues a WiFi power cycle procedure may be performed. The following procedure provides the instructions on how to conduct a WiFi power cycle:

 **NOTE:** Some ISPs (Internet Service Providers) provide a modem/router combo device.

Steps

1. Turn off your computer.
2. Turn off the modem.
3. Turn off the wireless router.
4. Wait for 30 seconds.
5. Turn on the wireless router.
6. Turn on the modem.
7. Turn on your computer.

Drain residual flea power (perform hard reset)

About this task

Flea power is the residual static electricity that remains in the computer even after it has been powered off and the battery is removed.

For your safety, and to protect the sensitive electronic components in your computer, you are requested to drain residual flea power before removing or replacing any components in your computer.

Draining residual flea power, also known as a performing a "hard reset", is also a common troubleshooting step if your computer does not power on or boot into the operating system.

To drain residual flea power (perform a hard reset)

Steps

1. Turn off your computer.
2. Disconnect the power adapter from your computer.
3. Remove the base cover.
4. Remove the battery.
5. Press and hold the power button for 20 seconds to drain the flea power.
6. Install the battery.
7. Install the base cover.
8. Connect the power adapter to your computer.
9. Turn on your computer.





NOTE: For more information about performing a hard reset, see the knowledge base article [000130881](https://www.dell.com/support) at www.dell.com/support.

Getting help and contacting Dell

Self-help resources

You can get information and help on Dell products and services using these self-help resources:

Table 21. Self-help resources

Self-help resources	Resource location
Information about Dell products and services	www.dell.com
My Dell app	
Tips	
Contact Support	In Windows search, type <code>Contact Support</code> , and press Enter.
Online help for operating system	www.dell.com/support/windows
Access top solutions, diagnostics, drivers and downloads, and learn more about your computer through videos, manuals and documents.	Your Dell computer is uniquely identified by a Service Tag or Express Service Code. To view relevant support resources for your Dell computer, enter the Service Tag or Express Service Code at www.dell.com/support . For more information on how to find the Service Tag for your computer, see Locate the Service Tag on your computer .
Dell knowledge base articles for a variety of computer concerns	<ol style="list-style-type: none"> 1. Go to www.dell.com/support. 2. On the menu bar at the top of the Support page, select Support > Knowledge Base. 3. In the Search field on the Knowledge Base page, type the keyword, topic, or model number, and then click or tap the search icon to view the related articles.

Contacting Dell

To contact Dell for sales, technical support, or customer service issues, see www.dell.com/contactdell.

 **NOTE:** Availability varies by country/region and product, and some services may not be available in your country/region.

 **NOTE:** If you do not have an active Internet connection, you can find contact information about your purchase invoice, packing slip, bill, or Dell product catalog.