

Instruction Manual

Thank you for purchasing this product.
Before using this product please read the instructions carefully.
After reading the instruction manual, please keep it for reference.

Caution



- Only use the supplied power cable.
- Do not plug the power cable into an outlet with incorrect voltage.
- Do not use the power cable if it is damaged, frayed, or broken.
- Ensure that the power cable is completely plugged into the outlet.
- Unplug the power cable from the outlet when the product is not in use.
- Do not block the air vents of the steering wheel unit.
- Keep the steering wheel at least 4 inches (10cm) away from the wall.
- Keep the air vents of the steering wheel unit clear of dust.
- Avoid long gameplay and try to take a 10-15 minute break every hour.
- If your hands, wrists, feet, or other parts of your body feel tired or sore, stop playing the game and take a break for few hours. If symptoms continue, stop gameplay and consult your doctor.
- During gameplay, hold the steering wheel with both hands in the correct position do not completely let go of the steering wheel.
- Keep your fingers away from the foot pedals during gameplay.
- Do not place your hands or arms near the rotating base of the steering wheel during gameplay.



Caution

Parents/Guardians:

Please read the following information carefully.

- This product contains small parts. Keep away from children under 3 years old.
- Keep this product away from small children or infants. Seek medical attention immediately if any small parts are swallowed.
- Long cord. Strangulation hazard.
- Keep the product away from dusty or humid areas.
- Do not use this product if it has been damaged or modified.
- Do not get this product wet. This may cause an electric shock or malfunction.
- Do not place this product near heat sources or leave under direct sunlight for an extended period. Overheating may cause malfunction.
- Do not touch the metal parts of the USB plug.
- Do not apply strong impact or weight on the product.
- Do not pull roughly or bend the cable of the product.
- Do not disassemble, modify or attempt to repair this product.
- If product needs cleaning, use only a soft dry cloth. Do not use any chemical agents like benzene or thinner.
- Do not use this product for anything other than its intended purpose. We are not responsible for any accidents or damages in the event of use other than the intended purpose.

Included

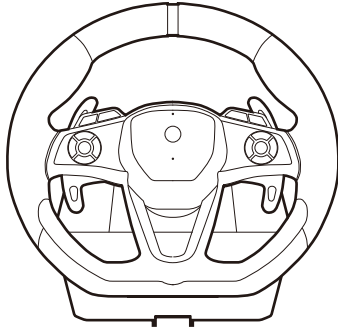

Steering unit

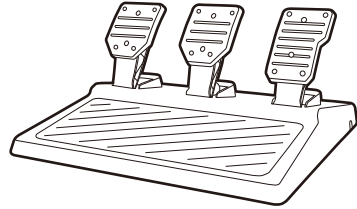

Foot pedals

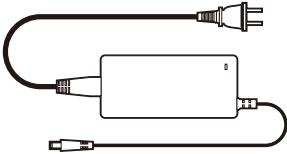

Power Cable

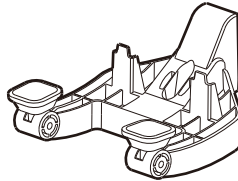

Clamp



Screw

Platform

Xbox Series X|S / Xbox One

Important

Before using this product with the Xbox Series X|S / Xbox One system, please read the included instructions carefully. Please check that your Xbox Series X|S / Xbox One is updated to the latest system firmware.

This product is designed for the Xbox Series X|S, but it can also be used with the Xbox One by following the instructions in this manual.

Layout

Steering unit

【Front View】

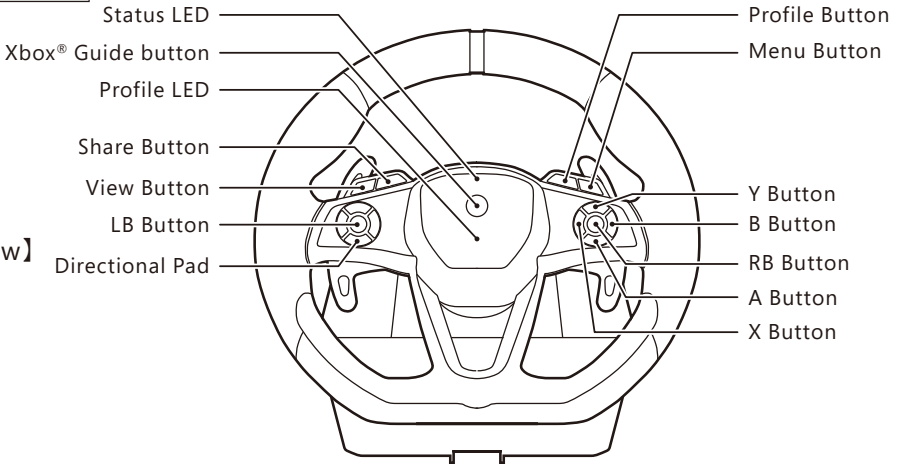

【Back View】

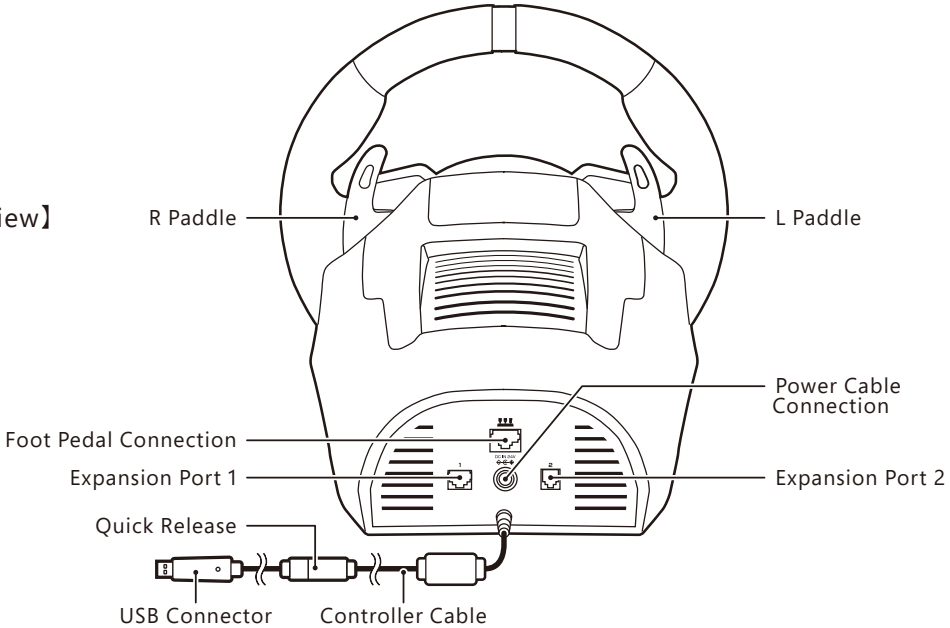

Foot pedals

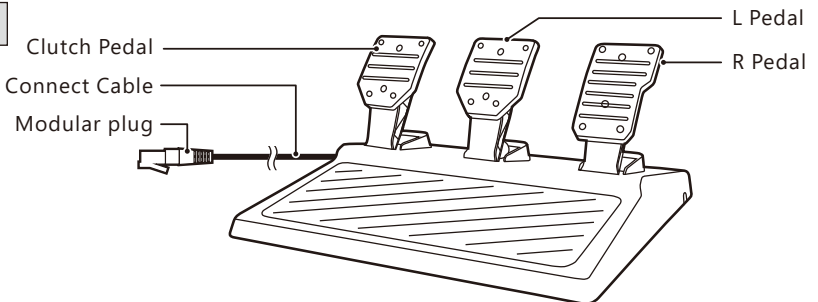

How to attach

When Mounting with a Clamp

- 1 Tighten the clamp into the steering unit base with the clamp screw.
- 2 Use the clamp to secure the steering unit to a flat, hard surface (i.e. table).

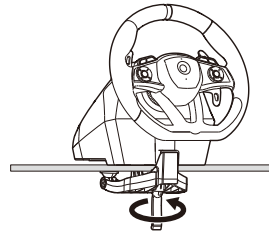
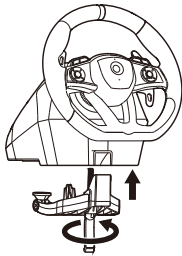

- * Do not attach to furniture made from glass or other fragile materials.
- * Carefully detach from furniture to prevent damage to furniture or product.

When Mounting to a Racing Wheel Stand

* Racing wheel stand sold separately

Screw the M6 screws into the holes as shown below.

- * M6 screws sold separately.
- * Ensure that the M6 screws do not exceed 26 mm in length as they may damage internal parts.

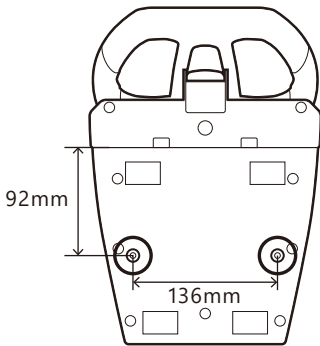

Bottom of Steering Unit

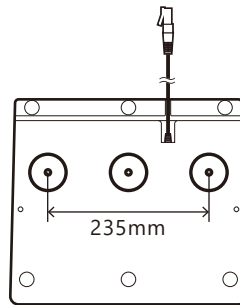

Bottom of Foot Pedals

Foot pedals

Slide the foot pedal cable through any of the three grooves on the bottom of the steering wheel unit.

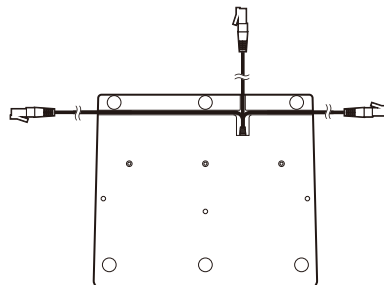

Bottom of Foot Pedals

How to Connect

Connect as shown in the image below.

- * When connecting each plug, do not push any buttons.
- * Check the direction of each plug carefully when connecting the cables.

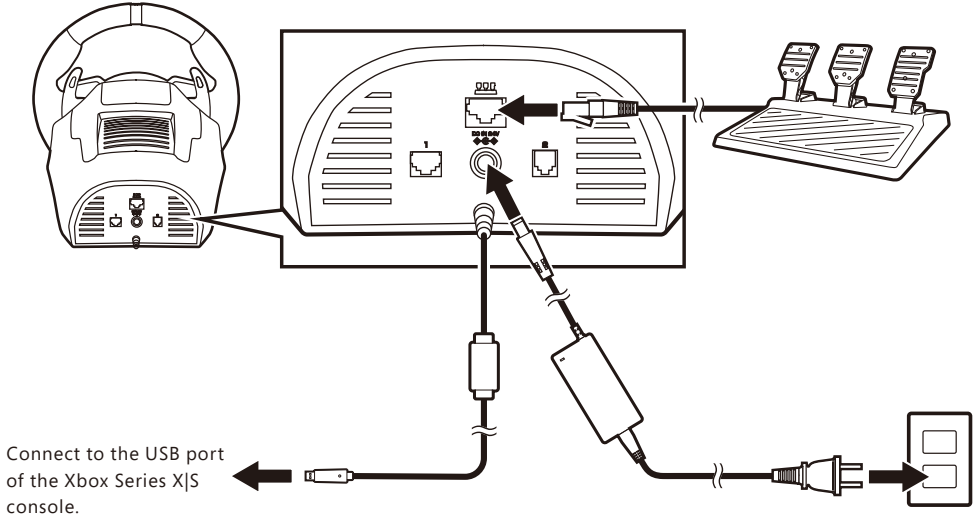

- ⚠ When connected and powered on, the steering wheel will automatically rotate in both directions in order to calibrate. Please do not touch the wheel or allow cables to be tangled during this calibration. There is a risk of injury or improper calibration.

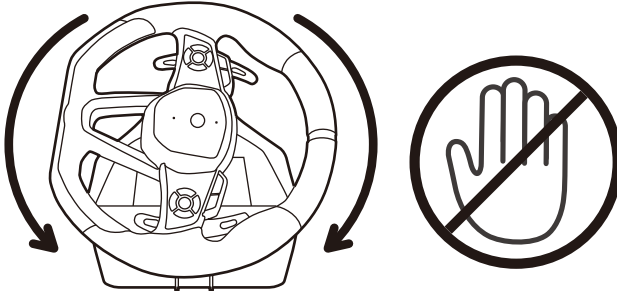

Quick Release

Your controller cord has a quick release. This is a safety feature designed to reduce the chance of the Xbox Series X|S console or computer from falling when the cord is pulled. If the console or computer falls and hits someone, especially a small child, it could cause a serious injury. To reduce the risk of injuries or damage to the console or computer, it is important to use the controller and the quick release properly. Use the controller connector, not the quick release, to routinely connect and disconnect the controller. If the quick release disconnects, simply reconnect it by aligning the grooved indentations and pressing the two parts completely together. The controller will not work unless the quick release is connected properly.



Never tape, glue, or otherwise prevent the quick release from pulling apart. The quick release reduces, but does not eliminate, the risk of the computer or console being pulled off its surface. To further reduce the risk:

- Do not allow anyone to pull on the controller or controller cord in a way that causes the computer or console to move.
- Do not allow controller cords to become crossed or tangled with one another.

Download App

『HORI FFB RWD Device Manager for Xbox Series X』

<How to Download>

- ① Search for "HORI" on the Microsoft Store.
- ② Install the "HORI FFB RWD Device Manager for Xbox Series X" App.

●About Profile

The Profile Button is used to toggle between profiles (profiles are adjusted via the HORI FFB RWD Device Manager for Xbox Series X).



Profile Button

Each time the Profile Button is pushed, the profiles cycle through Profile 1 to Profile 8.

The following features can be adjusted in the app:

- Steering Wheel Settings
- Assign Mode
- Force Feedback Settings
- Profile
- Foot Pedal Settings

The Profile LED will change based on Profile setting.

Profile Set	Profile LED
1	No LED
2	Green
3	Yellow
4	Red
5	Purple
6	Blue
7	Light Blue
8	White

Main Features

Steering unit

External Dimensions	: 300×360×310mm
Steering Diameter	: 300mm
Angle of Rotation	: 90°
Weight	: 3.4kg
Cable Length	: 3.0m
Power Supply	: DC5V / 500mA(max) 、DC 24V / 2.0A(max)

Foot pedals

External Dimensions	: 340×300×160mm
Weight	: 1.35kg
Cable Length	: 1.5m

Power Cable

Cable Length	: 2.6m
Input	: AC100V ~ AC240V
Output	: DC24V/2.0A(max)

THE FCC WANTS YOU TO KNOW

This device complies with part 15 of the FCC Rules. Operation is subject to the following two conditions: (1) This device may not cause harmful interference, and (2) this device must accept any interference received, including interference that may cause undesired operation.

NOTE: This equipment has been tested and found to comply with the limits for a Class B digital device, pursuant to part 15 of the FCC Rules. These limits are designed to provide reasonable protection against harmful interference in a residential installation. This equipment generates, uses and can radiate radio frequency energy and, if not installed and used in accordance with the instructions, may cause harmful interference to radio communications. However, there is no guarantee that interference will not occur in a particular installation. If this equipment does cause harmful interference to radio or television reception, which can be determined by turning the equipment off and on, the user is encouraged to try to correct the interference by one or more of the following measures:

- Reorient or relocate the receiving antenna.
- Increase the separation between the equipment and receiver.
- Connect the equipment into an outlet on a circuit different from that to which the receiver is connected.
- Consult the dealer or an experienced radio/TV technician for help.

The normal function of the product may be disturbed by strong electro-magnetic interference. If so, simply reset the product to resume normal operation by following the instruction manual (How to connect). In case the function does not resume, please relocate to an area which does not have electro-magnetic interference to use the product.

The wires are not to be inserted into socket-outlets.

The packaging must be retained since it contains important information.

PRODUCT DISPOSAL INFORMATION

Where you see this symbol on any of our electrical products or packaging, it indicates that the relevant electrical product or battery should not be disposed of as general household waste in Europe. To ensure the correct waste treatment of the product and battery, please dispose of them in accordance with any applicable local laws or requirements for disposal of electrical equipment or batteries. In so doing, you will help to conserve natural resources and improve standards of environmental protection in treatment and disposal of electrical waste. Applicable to EU countries and Turkey only.



EU and Turkey only

US

Warranty

HORI warrants to the original purchaser that the product purchased new in its original packaging shall be free of any defects in material and workmanship for a period of 90 days from the original date of purchase. If the warranty claim cannot be processed through the original retailer please contact HORI customer support directly at infous@hori.jp. Please visit <http://stores.horiusa.com/policies/> for warranty details.

EU

Warranty

For all warranty claims made within the first 30 days after purchase, please check with the retailer where the original purchase was made for details. If the warranty claim cannot be processed through the original retailer or for any other inquiries pertaining to our products, please contact HORI customer support directly at infoeu@hori.jp.

- The image on the package may differ from the actual product.
- The manufacturer reserves the right to change the product design or specifications without notice.
- Microsoft, Xbox, Xbox "Sphere" Design, Xbox Series X|S, Xbox One are trademarks of the Microsoft group of companies.
- HORI & HORI logo are registered trademarks of HORI.



MADE IN CHINA

Ages 6+