

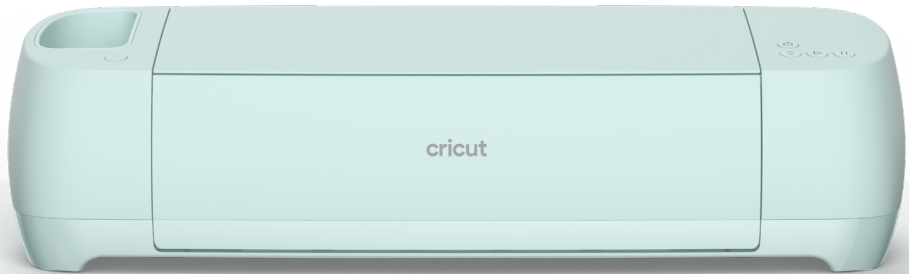

cricut explore 3



User Guide
Maunuel de l'utilisateur
Manual de usuario
Bedienungsanleitung

Manuale per l'utente
Manual do usuário
Gebruikershandleiding
Brugermanual

Bruksanvisning
Käyttöohje
Brukerveiledning







03

EN - English

07

FR - Français

11

ES - Español

15

DE - Deutsche

19

IT - Italiano

23

PT - Português

27

NL - Nederlands

31

DA - Dansk

35

SV - Svenska

39

NO - Norsk

43

FI - Suomalainen





03

Included

- Cricut Explore™ 3 machine
- Premium Fine-Point Blade + Housing
- Welcome Card
- Power adapter
- USB cable
- Free trial subscription to Cricut Access™ (for new subscribers)
- 100 ready-to-make projects online
- Material for a practice cut

Get started with Design Space™

Your creative journey starts with Design Space, a free, easy-to-learn design app for Cricut smart cutting machines. Here, you can browse thousands of images, projects, and fonts in the Cricut Library. Or design your own project from scratch.

Because it's cloud-based, you can start a design on your computer and finish it on your mobile device. To design without an internet connection, just download your favorite fonts and projects for offline use.

Download Design Space at cricut.com/setup

Cricut Access™

With a Cricut Access subscription, in addition to the free images included in Design Space, you'll have access to an ever-growing library of images, fonts, and projects. Your first month is free! Learn more at cricut.com/access





Machine overview

1. Slot for mobile device
2. Clamp A
3. Clamp B
4. Storage cup
5. Storage
6. Power button
7. Load/Unload button
8. Go button
9. Pause button
10. USB port
11. Material guides

EN

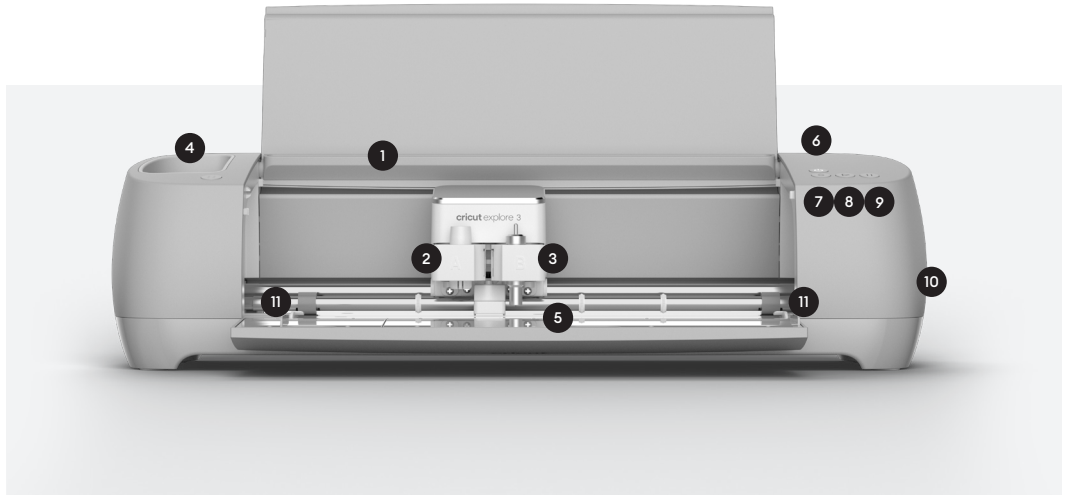

For more info, see cricut.com/more





05

Load Smart Materials™

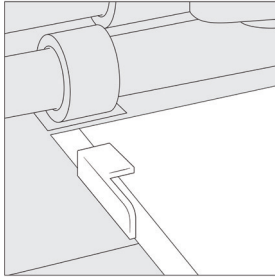

1. Position material under material guides.

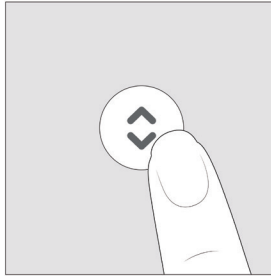

2. Hold against rollers as you press the flashing Load/Unload button.

Load machine mat with material

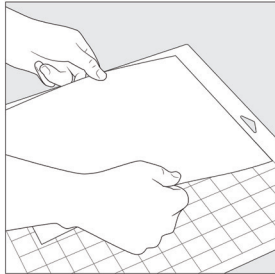

1. Remove plastic cover, then align material onto mat. For fabric, use brayer to smooth down.

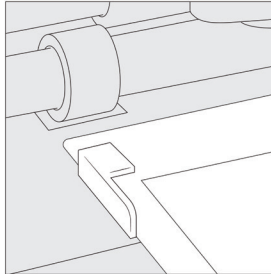

2. When prompted, insert mat under material guides.

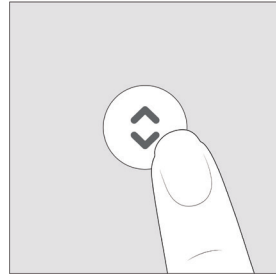

3. Hold mat against rollers as you press flashing Load/Unload button.





Change tool

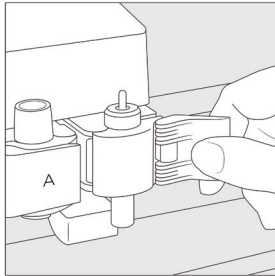

1. Open Clamp B, and remove tool housing.

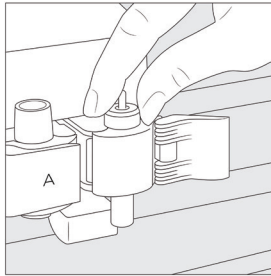

2. Firmly seat new tool.

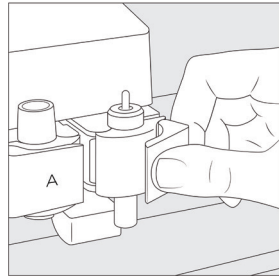

3. Close clamp.

Use caution, and follow instructions when replacing blade.
For instructions, see blade packaging or help.cricut.com/blades

For more info, see cricut.com/more



07

Inclus

- Machine Cricut Explore™ 3
- Abonnement d'essai gratuit à Cricut Access™
- Lame à pointe fine Premium + boîtier (pour les nouveaux abonnés)
- Carte de bienvenue
- 100 projets en ligne prêts à la création
- Adaptateur secteur
- Matériau pour découpe d'essai
- Câble USB

Débutez avec Design Space™

Votre voyage créatif commence avec Design Space, une application de conception gratuite et facile à apprendre pour les machines de découpe intelligentes Cricut. Vous pouvez parcourir des milliers d'images, de projets et de polices depuis la bibliothèque Cricut. Ou bien vous pouvez créer votre propre projet à partir de zéro.

Parce que tout est basé dans le cloud, vous pouvez commencer un projet sur votre ordinateur et le terminer sur votre appareil mobile. Pour continuer à créer sans connexion Internet, téléchargez simplement vos polices et projets préférés pour une utilisation hors ligne.

Téléchargez Design Space via cricut.com/setup

Cricut Access™

Avec un abonnement Cricut Access, vous avez accès à une bibliothèque grandissante d'images, de polices de caractères et de projets en plus des images gratuites déjà incluses. Votre premier mois est gratuit ! Pour en savoir plus, visitez cricut.com/access





Vue d'ensemble de la machine

- | | | |
|-------------------------------------|-----------------------------|--|
| 1. Emplacement pour appareil mobile | 5. Stockage | 9. Bouton Pause |
| 2. Mâchoire A | 6. Bouton d'alimentation | 10. Port USB |
| 3. Mâchoire B | 7. Bouton Charger/Décharger | 11. Roulettes de guidage des matériaux |
| 4. Pot de rangement | 8. Bouton Aller | |

FR

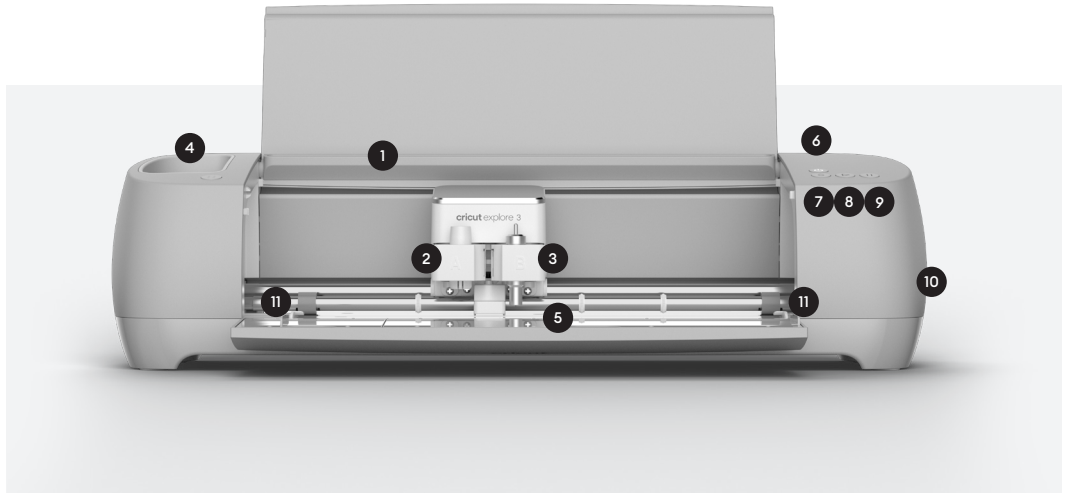

Pour plus d'informations, visitez cricut.com/more





09

Charger un rouleau Smart Materials™

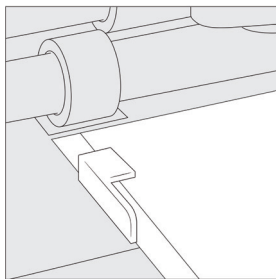

1. Placez le matériau sous les roulettes de guidage.

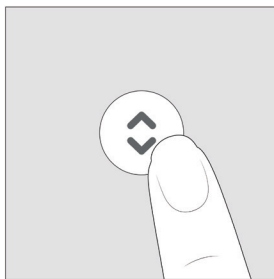

2. Maintenez-le contre les rouleaux tout en pressant le bouton Charger/ Décharger qui clignote.

Chargez le tapis de découpe avec un matériel

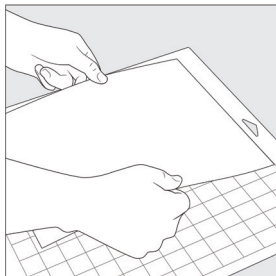

1. Retirez le couvercle en plastique, puis alignez le matériel sur le tapis. Utilisez la brosse pour lisser les tissus.

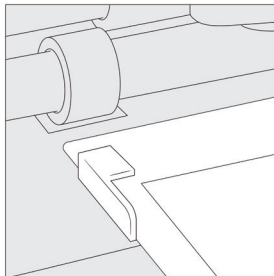

3. Lorsque vous y êtes invité, insérez le tapis sous les roulettes de guidage.

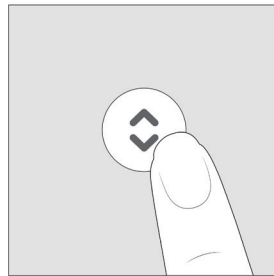

4. Maintenez le tapis contre les rouleaux en appuyant sur le bouton Charger/Décharger qui clignote.





Changer d'outil

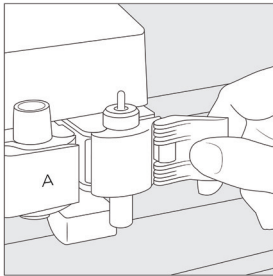

1. Ouvrez la mâchoire B et retirez l'outil.

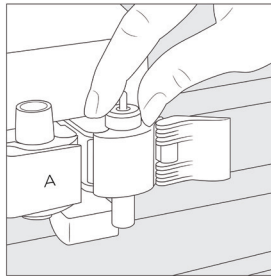

2. Enfoncez fermement le nouvel outil.

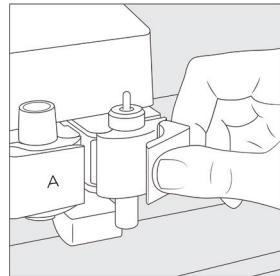

3. Fermez la mâchoire.

FR

Faites preuve de prudence et suivez les instructions lors du emplacement de la lame. Pour plus d'informations, consultez l'emballage des lames ou le site help.cricut.com/blades

Pour plus d'informations, visitez cricut.com/more



Incluye

- Máquina Cricut Explore™ 3
- Cuchilla de punta fina Premium y portacuchillas
- Tarjeta de bienvenida
- Adaptador de corriente
- Cable USB
- Suscripción de prueba gratuita a Cricut Access™ (para nuevos suscriptores)
- 100 proyectos prediseñados en línea
- Material para realizar cortes de prueba

Primeros pasos con Design Space™

Tu viaje creativo comienza con Design Space, una aplicación de diseño gratuita y fácil de usar para las máquinas de corte inteligente de Cricut. Aquí podrás explorar miles de imágenes, proyectos y fuentes en la biblioteca de Cricut. O diseñar tu propio proyecto desde cero.

Como está alojada en la nube, puedes iniciar un diseño en tu equipo informático y terminarlo en tu dispositivo móvil. Para diseñar sin conexión a internet, solo tienes que descargar tus fuentes y proyectos favoritos para usarlos sin conexión.

Descarga Design Space en cricut.com/setup

Cricut Access™

Con una suscripción a Cricut Access, además de las imágenes gratuitas incluidas en Design Space, tendrás acceso a una biblioteca de imágenes, fuentes y proyectos que nunca deja de crecer. ¡Tu primer mes es gratis! Más información en cricut.com/access



Descripción de la máquina

- | | | |
|-------------------------------------|----------------------------|-----------------------|
| 1. Ranura para el dispositivo móvil | 5. Almacenamiento | 9. Botón de pausa |
| 2. Cabezal A | 6. Botón de encendido | 10. Puerto USB |
| 3. Cabezal B | 7. Botón de carga/descarga | 11. Guías de material |
| 4. Copa de almacenamiento | 8. Botón de inicio | |

ES

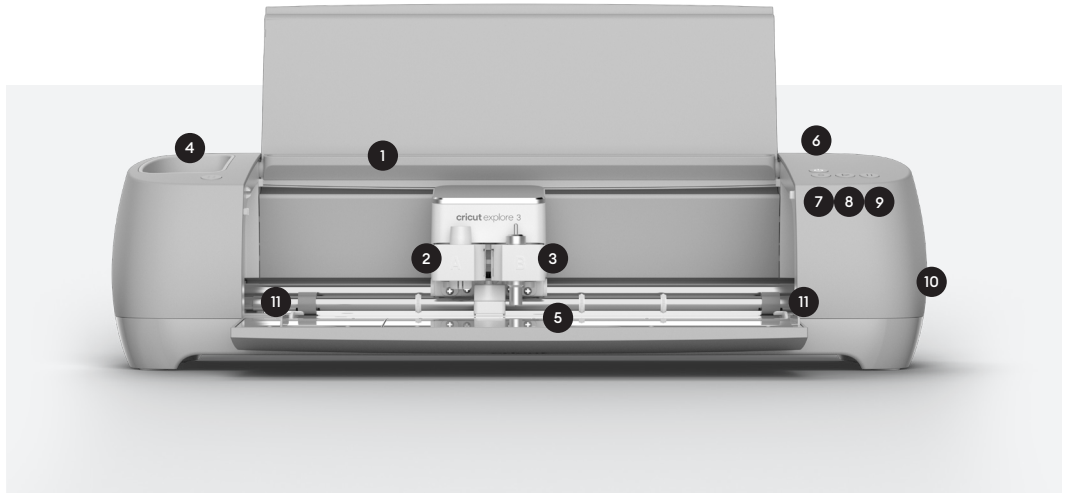

Para obtener más información, consulta cricut.com/more





Cargar Smart Materials™

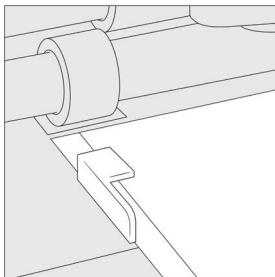

1. Coloca el material debajo de las guías de material.

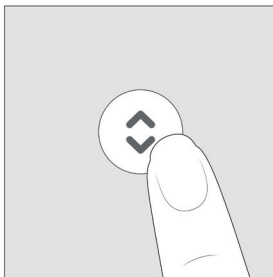

2. Manténlo presionado contra los rodillos mientras pulsas el botón parpadeante de carga/descarga.

Cargar el material en el tapete de la máquina

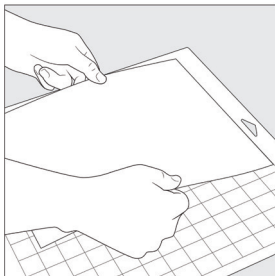

1. Retira la cubierta de plástico y alinea el material sobre el tapete. Alisa la tela con el rodillo.

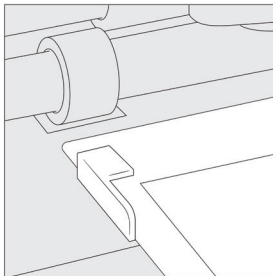

3. Cuando se te indique, inserta el tapete debajo de las guías de material.

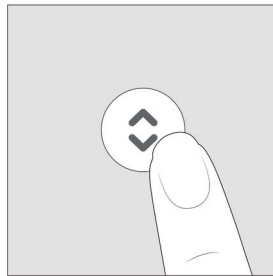

4. Mantén presionado el tapete contra los rodillos mientras pulsas el botón parpadeante de carga/descarga.





Cambiar herramienta

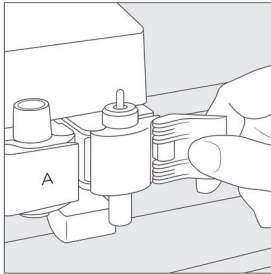

1. Abre el cabezal B y retira la herramienta.

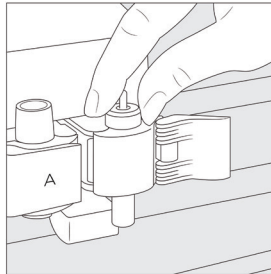

2. Asienta firmemente la nueva herramienta.

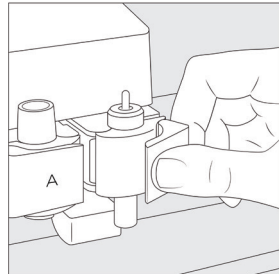

3. Cierra el cabezal.

ES

Ten cuidado y sigue las instrucciones cuando cambies la cuchilla.
Para más información, mira el envoltorio de la cuchilla o entra
en help.cricut.com/blades

Para obtener más información, consulta cricut.com/more



Eingeschlossen

- Cricut Explore™ 3-Maschine
- Premium-Feinschnittklinge und Gehäuse
- Willkommenskarte
- Netzteil
- USB-Kabel
- Kostenlose Testmitgliedschaft für Cricut Access™ (für neue Abonnenten)
- 100 Fixfertig-Projekte online
- Material für einen Testschnitt

Mit Design Space™ loslegen

Deine kreative Reise beginnt mit Design Space, einer kostenlosen, leicht erlernbaren Design-App für smarte Schneidemaschinen von Cricut. Hier kannst du Tausende von Bildern, Projekten und Schriftarten in der Cricut-Bibliothek durchsuchen. Oder dein eigenes Projekt von Grund auf gestalten.

Da es cloudbasiert ist, kannst du ein Design auf deinem Computer beginnen und es auf deinem Mobilgerät beenden. Lade einfach deine Lieblingsschriftarten und -projekte für die Offline-Nutzung herunter, um ohne Internetverbindung entwerfen zu können.

Design Space auf cricut.com/Setup herunterladen

Cricut Access™

Mit einem Cricut Access-Abonnement erhältst du zusätzlich zu den kostenlosen Bildern in Design Space Zugriff auf eine ständig wachsende Bibliothek aus Bildern, Schriftarten und Projekten. Der erste Monat ist kostenlos! Weitere Infos unter cricut.com/access



Maschinenübersicht

- | | | |
|--------------------------|-------------------------------|-----------------------|
| 1. Slot für Mobilgerät | 5. Aufbewahrungsfach | 9. Pause-Taste |
| 2. Klemme A | 6. Netzschalter | 10. USB-Anschluss |
| 3. Klemme B | 7. Einziehen-/Auswerfen-Taste | 11. Materialführungen |
| 4. Aufbewahrungsbehälter | 8. Los-Taste | |

DE

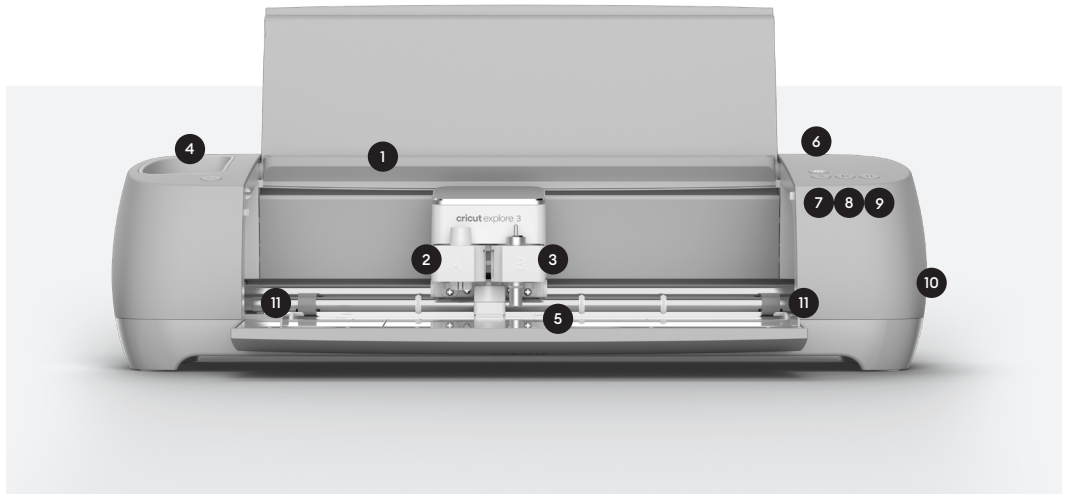

Weitere Infos unter cricut.com/more



Smart Materials™ laden

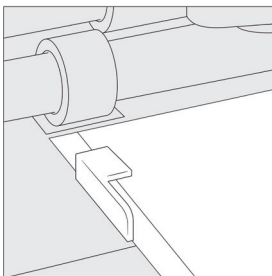

1. Material unter Materialführungen positionieren.

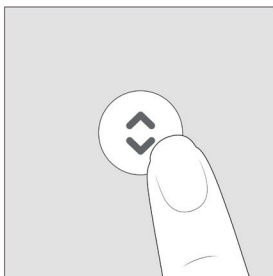

2. Gegen die Rollen halten und gleichzeitig die blinkende Einziehen-/Auswerfen-Taste drücken.

Schneidematte mit Material laden

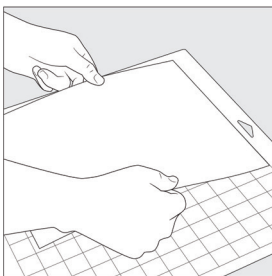

1. Kunststoffolie entfernen und anschließend Material auf Matte ausrichten. Bei Verwendung von Stoff diesen mit Handroller glätten.

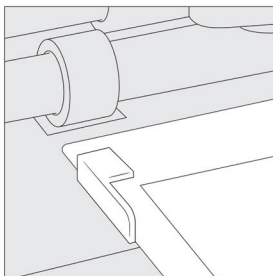

3. Bei Aufforderung die Schneidematte unter Materialführungen einschieben.

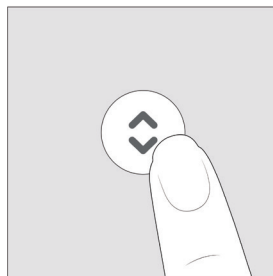

4. Matte gegen Rollen halten und gleichzeitig die blinkende Einziehen-/Auswerfen-Taste drücken.





Werkzeug wechseln

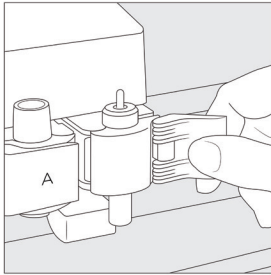

1. Klemme B öffnen und Werkzeug entfernen.

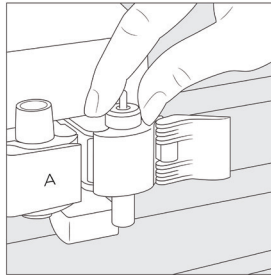

2. Neues Werkzeug einrasten lassen.

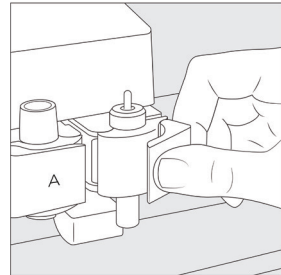

3. Klemme schließen.

DE

Beim Ersetzen der Klinge bitte vorsichtig vorgehen und Anweisungen befolgen. Die Anweisungen sind auf der Klingerverpackung bzw. unter help.cricut.com/blades verfügbar.

Weitere Infos unter cricut.com/more



Incluso

- Macchina Cricut Explore™ 3
- Lama a punta fine di prima qualità + Alloggiamento
- Biglietto di benvenuto
- Adattatore di alimentazione
- Cavo USB
- Abbonamento di prova gratuito a Cricut Access™ (per i nuovi abbonati)
- 100 progetti pronti per essere creati online
- Materiale per eseguire tagli di prova

Inizia con Design Space™

Il tuo viaggio creativo inizia con Design Space, un'applicazione per la progettazione gratuita e intuitiva per le macchine da taglio intelligenti Cricut. Qui puoi cercare migliaia di immagini, progetti e font nell'archivio Cricut. Oppure puoi creare il tuo progetto da zero.

Poiché è basata su cloud, puoi avviare un progetto sul tuo computer e terminarlo sul tuo dispositivo mobile. Per progettare senza connessione internet, scarica i tuoi font e progetti preferiti per l'uso offline.

Scarica Design Space su cricut.com/setup

Cricut Access™

Con un abbonamento Cricut Access, oltre alle immagini gratuite incluse in Design Space, avrai accesso a un archivio in continua espansione di immagini, font e progetti. Il tuo primo mese è gratuito! Maggiori informazioni su cricut.com/access





Panoramica della macchina

- | | | |
|---|-------------------------------|-------------------------|
| 1. Alloggiamento per dispositivo mobile | 4. Vano contenitore | 8. Pulsante di avvio |
| 2. Morsetto A | 5. Contenitore | 9. Pulsante di pausa |
| 3. Morsetto B | 6. Tasto di accensione | 10. Porta USB |
| | 7. Pulsante di carico/scarico | 11. Guide per materiale |

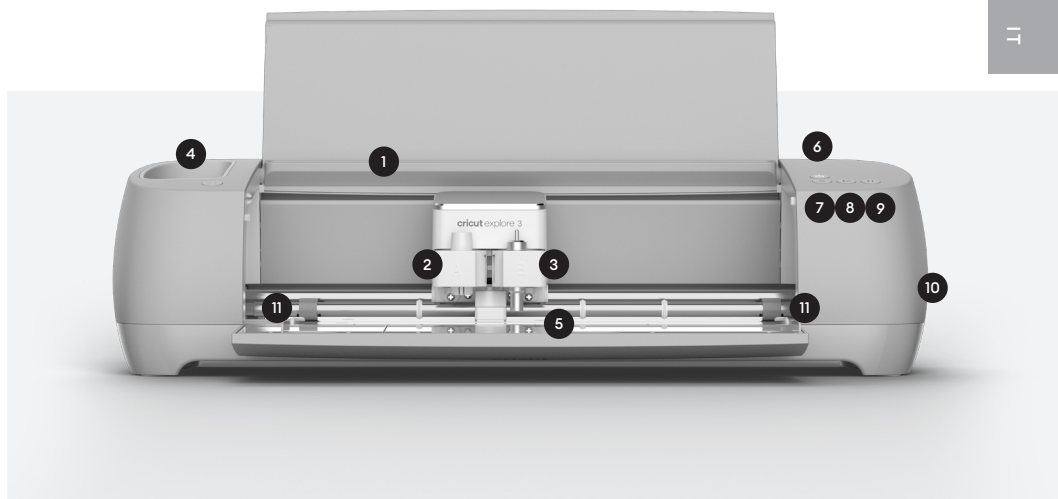

Per maggiori informazioni, visitare cricut.com/more





Caricare Smart Materials™

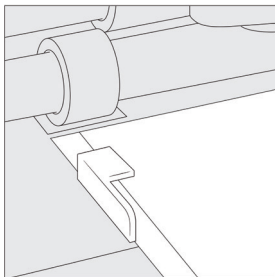

1. Posizionare il materiale sotto le guide per materiale.

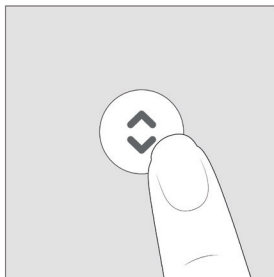

2. Mantenere il materiale contro i rulli mentre si preme il pulsante lampeggiante di carico/scarico.

Caricare il tappetino per macchina insieme al materiale

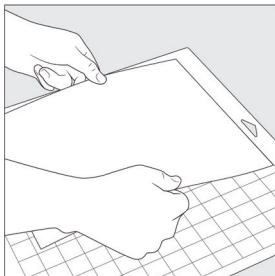

1. Rimuovere la copertura in plastica, poi allineare il materiale sul tappetino. Se si usa il tessuto, usare il rullo per appianarlo.

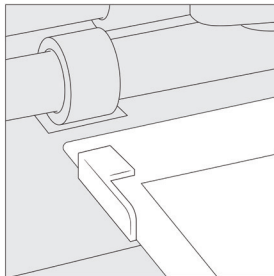

3. Quando richiesto, inserire il tappetino sotto le guide per materiale.

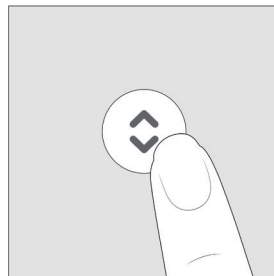

4. Mantenere il tappetino contro i rulli mentre si preme il pulsante lampeggiante di carico/scarico.





Cambiare strumento

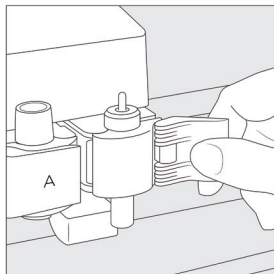

1. Aprire il morsetto B e rimuovere lo strumento.

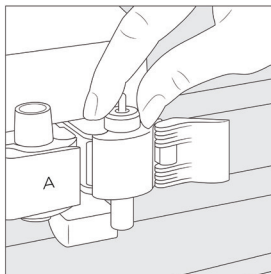

2. Posizionare il nuovo strumento in modo stabile.

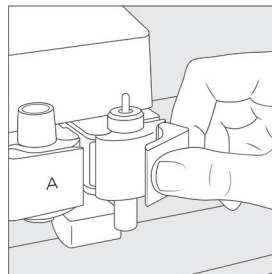

3. Chiudere il morsetto.

IT

Presta estrema attenzione e segui le istruzioni quando sostituisci la lama. Per istruzioni, guarda sulla confezione della lama o consulta help.cricut.com/blades

Per maggiori informazioni, visitare cricut.com/more



Incluso

- Máquina Cricut Explore™ 3
- Lâmina de ponta fina premium + Suporte
- Cartão de boas-vindas
- Adaptador de energia
- Cabo USB
- Teste grátis de associação ao Cricut Access™ (para novos assinantes)
- 100 projetos online prontos para fazer
- Material para corte de treinamento

Começando com o Design Space™

A sua jornada criativa começa com o Design Space, um aplicativo gratuito e fácil de usar para as máquinas de corte inteligente Cricut. Aqui, você pode navegar por milhares de imagens, projetos e fontes na Biblioteca Cricut. Ou então, criar o seu próprio projeto do zero.

Por ser baseado na nuvem, você pode iniciar um desenho no seu computador e terminá-lo no seu dispositivo móvel. Para criar sem uma conexão com a internet, basta baixar suas fontes e projetos favoritos para usar offline.

Baixe o Design Space em cricut.com/setup

Cricut Access™

Com uma assinatura do Cricut Access, além das imagens gratuitas incluídas no Design Space, você terá acesso a uma biblioteca cada vez maior de imagens, fontes e projetos. O seu primeiro mês é gratuito! Saiba mais em cricut.com/access





Visão geral da máquina

- | | | |
|----------------------------------|----------------------------------|------------------------|
| 1. Slot para dispositivos móveis | 5. Armazenamento | 9. Botão de pausa |
| 2. Braçadeira A | 6. Botão de energia | 10. Entrada USB |
| 3. Braçadeira B | 7. Botão de carregar/descarregar | 11. Guias de materiais |
| 4. Copo de armazenamento | 8. Botão de avançar | |

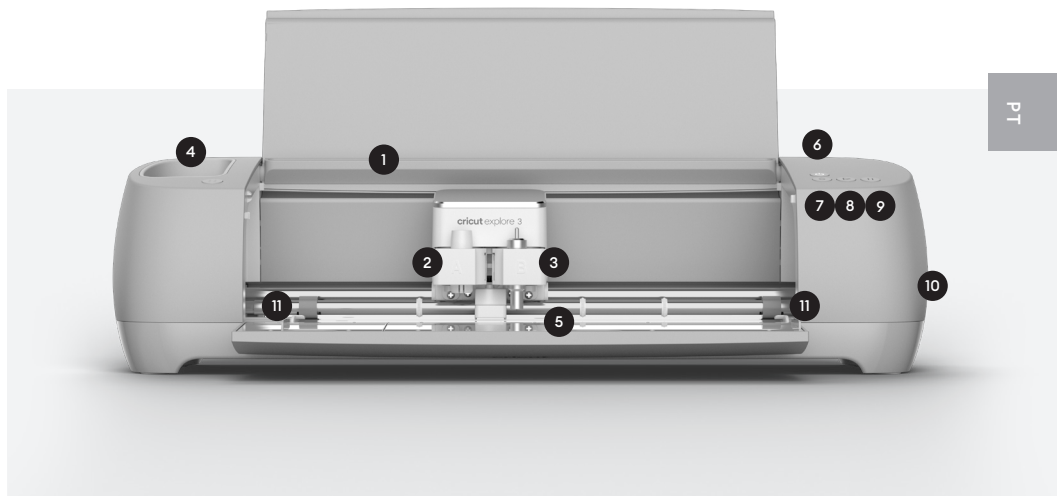

Para mais informações, consulte cricut.com/mais





Carregar Smart Materials™

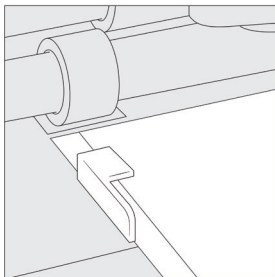

1. Posicione o material de acordo com os guias de materiais.

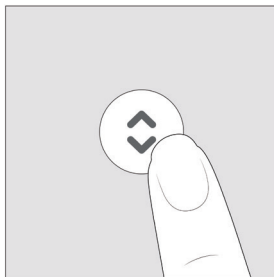

2. Segure-o contra os rolos e pressione o botão piscante Carregar/Descarregar.

Carregue a base da máquina com material

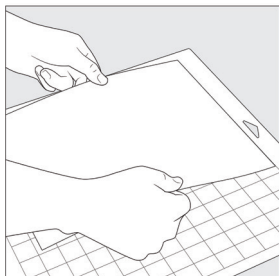

1. Remova a capa de plástico, então alinhe o material na base. Para tecido, use o rolo para suavizar.

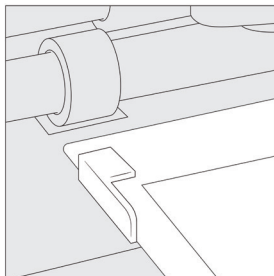

3. Quando solicitado, insira a base de acordo com os guias dos materiais.

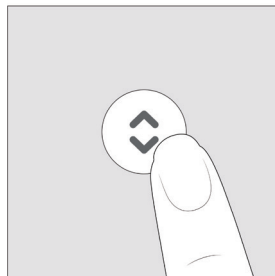

4. Segure a base contra os rolos e pressione o botão piscante Carregar/Descarregar.





Mudar ferramenta

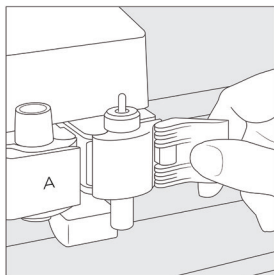

1. Abra a braçadeira B e remova a ferramenta.

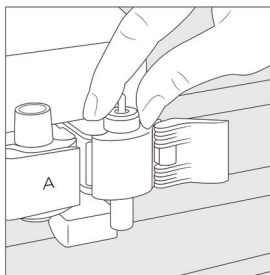

2. Assente a nova ferramenta firmemente.

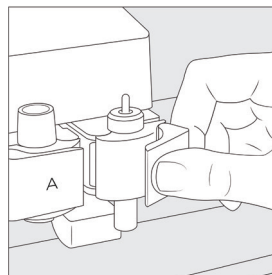

3. Feche a braçadeira.

Tenha cuidado e siga as instruções quando substituir a lâmina.
Para instruções, veja a embalagem de lâminas ou
help.cricut.com/blades

Para mais informações, consulte cricut.com/mais



Inbegrepen

- Cricut Explore™ 3 machine
- Kwaliteitsklasse standaardmes + schede
- Welkomstkaart
- Stroomadapter
- USB-kabel
- Gratis proefabonnement op Cricut Access™ (voor nieuwe abonnees)
- 100 kant-en-klare projecten online
- Materiaal om eerst mee te oefenen

Aan de slag met Design Space™

Begin je creatieve reis met Design Space, een gratis en gemakkelijk te leren ontwerp-app voor slimme Cricut-snijmachines. Blader door duizenden afbeeldingen, projecten en lettertypen in de Cricut Bibliotheek. Of ontwerp een compleet nieuw eigen project.

Alles staat in de cloud. Je kunt op je computer een ontwerp beginnen en het op je mobiele apparaat afronden. Om te ontwerpen zonder internetverbinding, download je gewoon je favoriete lettertypen en projecten voor offline gebruik.

Download Design Space op cricut.com/setup

Cricut Access™

Met een Cricut Access-abonnement heb je, naast de gratis afbeeldingen in Design Space, toegang tot een almaar groeiende bibliotheek met afbeeldingen, lettertypen en projecten. Je eerste maand is gratis! Kom meer te weten op cricut.com/access





Overzicht van de machine

- | | | |
|-------------------------------|---------------------|------------------------|
| 1. Sleuf voor mobiel apparaat | 5. Opslag | 9. Pauzeknop |
| 2. Klem A | 6. Aan/uitknop | 10. USB-poort |
| 3. Klem B | 7. Knop Load/Unload | 11. Materiaalgeleiders |
| 4. Bewaarbeker | 8. Go-knop | |

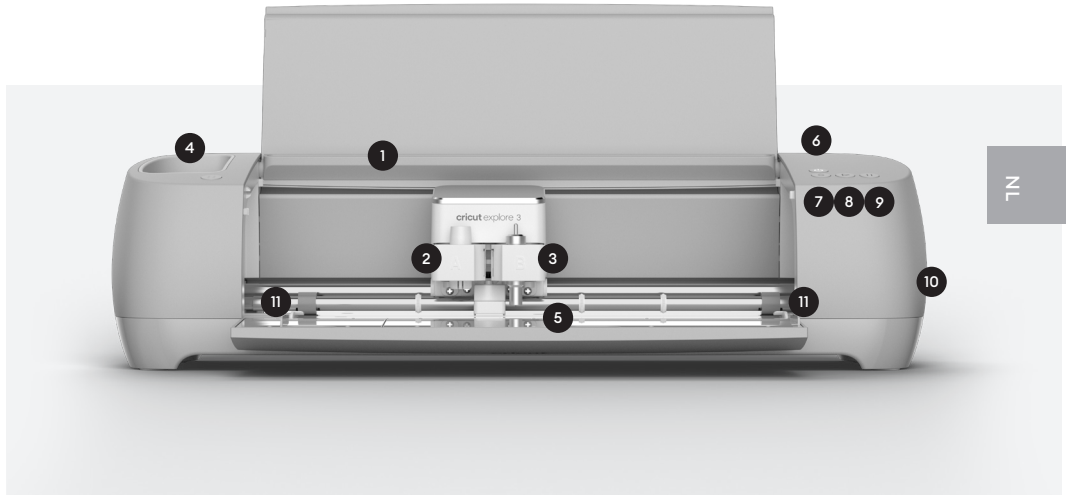

Ga voor meer informatie naar cricut.com/more





Laad Smart Materials™

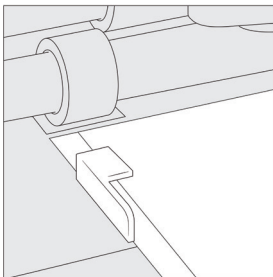

1. Plaats het materiaal onder de materiaalgeleiders.

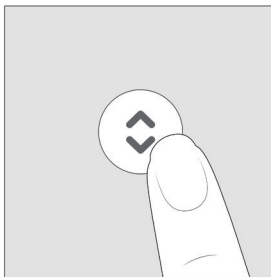

2. Plaats tegen de rollers terwijl je op de knipperende knop Load/Unload drukt.

Laad de machinemat met materiaal

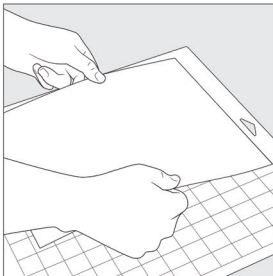

1. Verwijder de plastic hoes en lijn het materiaal uit op de mat. Gebruik een brayer om stof glad te strijken.

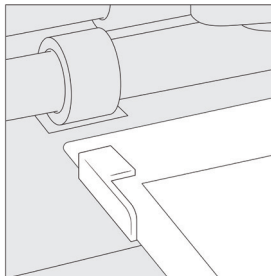

3. Plaats desgevraagd de mat onder de materiaalgeleiders.

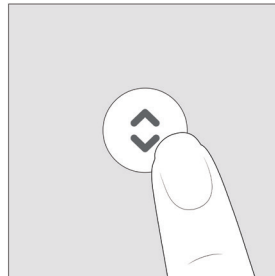

4. Houd de mat tegen de rollers, terwijl je de op de knipperende Load/Unload-knop drukt.





Gereedschap wisselen

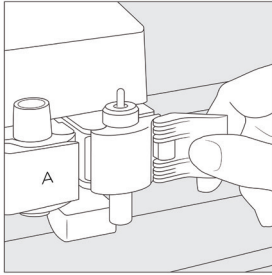

1. Open Klem B en verwijder het gereedschap.

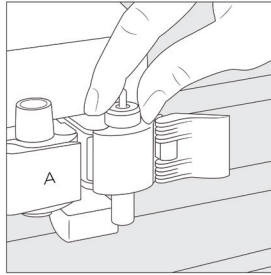

2. Plaats het nieuwe gereedschap en zet goed vast.

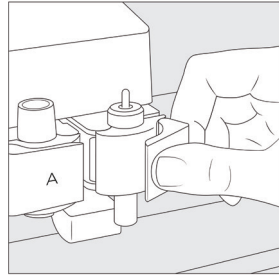

3. Sluit de klem.

Wees voorzichtig en volg de instructies bij het vervangen van het mes. Zie de verpakking van het mes of help.cricut.com/blades voor instructies

Z

Ga voor meer informatie naar cricut.com/more



Indeholder

- Cricut Explore™ 3 maskine
- Premium Fine-Point klinge + klingeholder
- Velkomstkort
- Strømkabel
- USB-kabel
- Gratis prøvemedslemskab til Cricut Access™ (for nye abonnenter)
- 100 projekter online, der er klar til at blive lavet
- Materiale til en prøveudskæring

Kom i gang med Design Space™

Din kreative rejse starter med Design Space, en gratis, lærenem app til Cricut's smarte skæremaskiner. Her kan du gennemse tusindvis billeder, projekter og skrifttyper i Cricut-biblioteket. Eller design dit eget projekt fra bunden.

Eftersom det er cloud-based, kan du starte et design på din computer og færdiggøre det på din mobilenhed. For at designe uden internetforbindelse, skal du blot downloade dine foretrukne skrifttyper og projekter til offline brug.

Download Design Space fra cricut.com/setup

Cricut Access™

Med et medlemskab til Cricut Cricut Access vil du, udover de gratis billeder inkluderet i Design Space, have adgang til et konstant voksende bibliotek af billeder, skrifttyper og projekter. Din første måned er gratis! Få mere information på cricut.com/access





Overzicht over maskinen

- | | | |
|----------------------------------|---------------------|----------------------------|
| 1. Udvidelsesstik til mobilenhed | 5. Opbevaring | 9. Pause-knap |
| 2. Klemme A | 6. Strøm-knap | 10. USB-portal |
| 3. Klemme B | 7. Load/Unload-knap | 11. Materiale vejledninger |
| 4. Opbevaringsbæger | 8. Start-knap | |

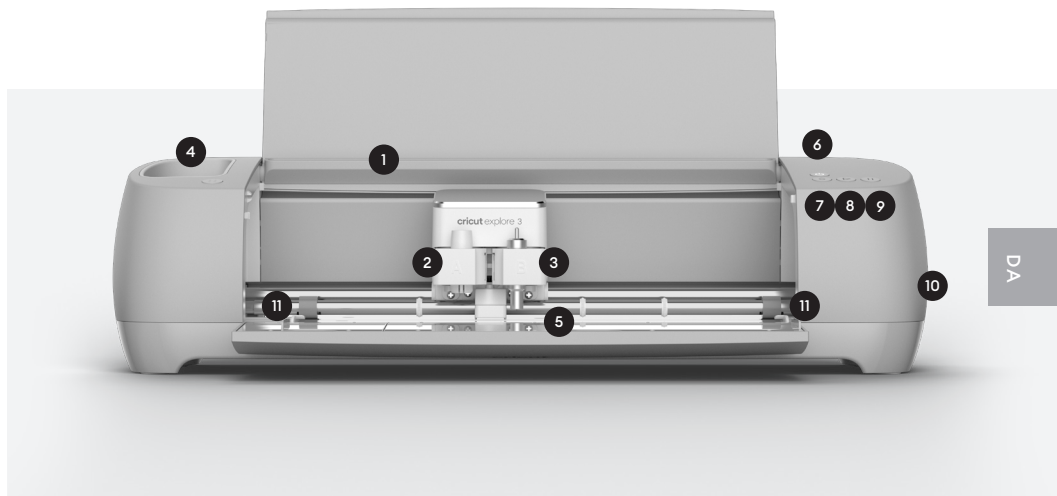

For yderligere oplysninger, se cricut.com/more





Indlæs Smart Materials™

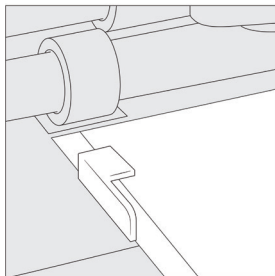

1. Placer materiale under materiale vejledninger.

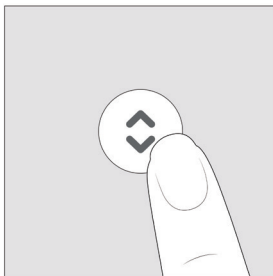

2. Hold op i mod rullerne, mens du trykker på den blinkende Load/Unload-knap.

Fyld materiale på maskinemåtte

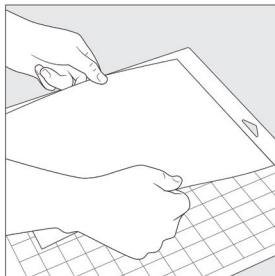

1. Fjern plastikbeskyttelsen, og placér derefter materialet på måtten, så det flugter. Anvend en udruller, hvis det er stof til at glatte materialet ud.

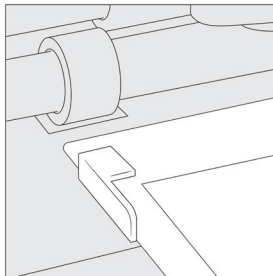

3. Anbring derefter underlaget under materiale vejledninger.

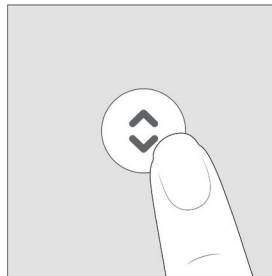

4. Hold underlaget mod rullerne, mens du trykker på Load/Unload-knappen.





Skift værktøj

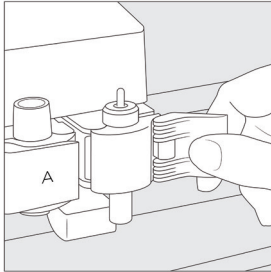

1. Åbn Klemme B, og fjern værktøj.

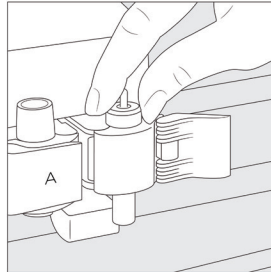

2. Indsæt nyt værktøj.

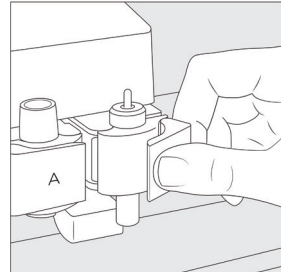

3. Luk Klemme.

Vær forsigtig, og følg instruktionerne, når du udskifter klingens.
For instruktioner, se blademballage eller help.cricut.com/blades

DA

For yderligere oplysninger, se cricut.com/more





Sisältää

- Cricut Explore™ 3 -kone
- Premium fine-point-blad + hölje
- Välkomstkort
- Nätdapter
- USB-kabel
- Gratis provmedlemskap i Cricut Access™ (för nya medlemmar)
- 100 projekt som är redo att skapas online
- Material för en provskärning

Kom igång med Design Space™

Din kreativa resa börjar med Design Space, en kostnadsfri app för Cricut smarta skärmaskiner som är lätt att lära sig. Här kan du bläddra igenom tusentals bilder, projekt och teckensnitt i Cricut-biblioteket. Eller utforma ditt eget projekt från noll.

Eftersom det är molnbaserat kan du starta en design på datorn och avsluta den på din mobila enhet. För att designa utan internet-anslutning kan du helt enkelt ladda ner dina favoritteckensnitt och -projekt för användning offline.

Ladda ner Design Space på cricut.com/setup

Cricut Access™

Med ett Cricut Access-medlemskap har du förutom de fria bilderna som ingår i Design Space också tillgång till ett ständigt växande bibliotek med bilder, teckensnitt och projekt. Din första månad är kostnadsfri! Läs mer på cricut.com/access





Maskinöversikt

1. Spår för mobil enhet
2. Klämma A
3. Klämma B
4. Förvaringsfack
5. Lagring
6. Strömknapp
7. Lägg i/ta ur-knapp
8. Startknapp
9. Pausknapp
10. USB-port
11. Materialskenor

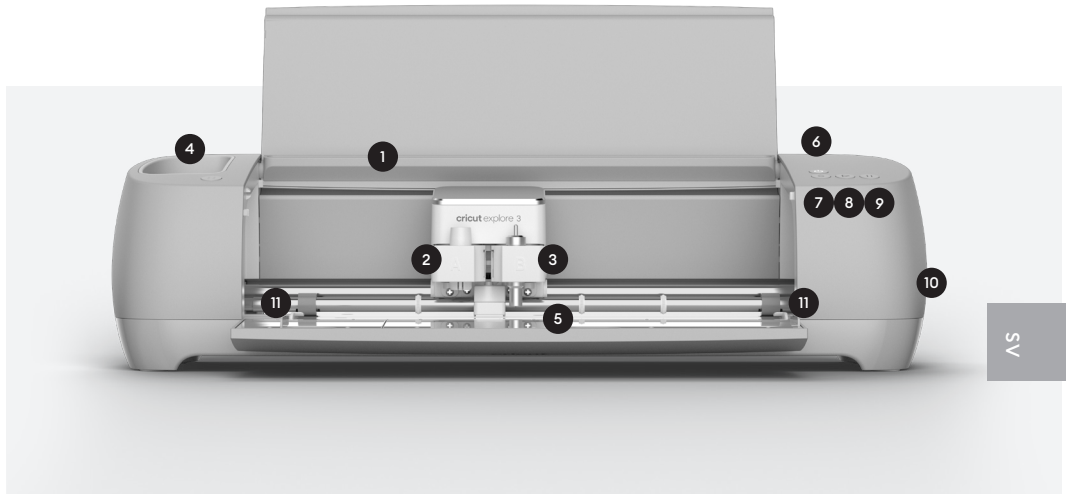

För mer information, se cricut.com/more





Ladda Smart Materials™

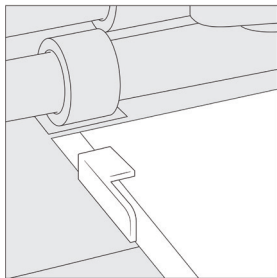

1. Placera material under materialskenorna.

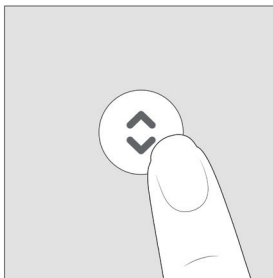

2. Håll emot rullarna medan du trycker på den blinkande Lägg i/ta ur-knappen.

Lägg i maskinmatta med material

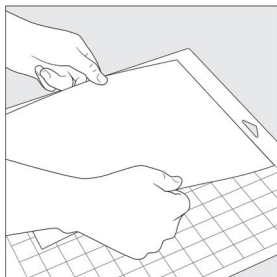

1. Ta bort plasthöljet och anpassa materialet på mattan. När det gäller tyg ska du använda en rulle för att släta ut det.

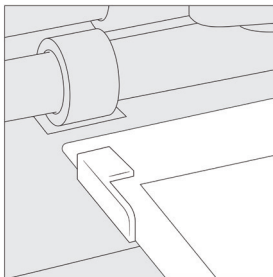

3. På begäran ska mattan föras in under materialskenorna.

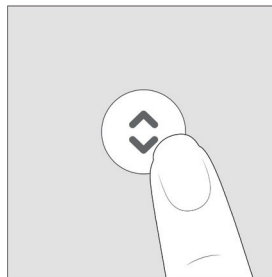

4. Håll mattan mot rullarna medan du trycker på den blinkande Lägg i/ta ur-knappen.





Byt verktyg

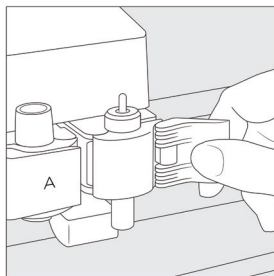

1. Öppna Klämma B och ta bort verktyget.

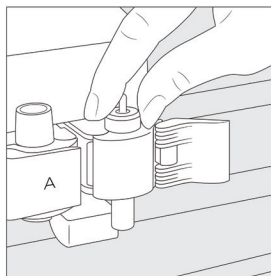

2. Sätt in det nya verktyget ordentligt.

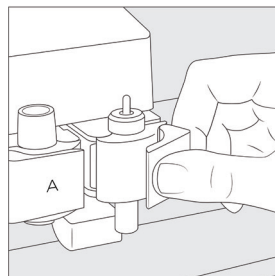

3. Stäng klämma.

Var försiktig och följ instruktionerna när du byter blad. För instruktioner, se blademballage eller help.cricut.com/blades

AS

För mer information, se cricut.com/more





Medfølger

- Cricut Explore™ 3-maskin
- Premium høykvalitetsblad + hus
- Velkomstkort
- Strømadapter
- USB-kabel
- Gratis prøveabonnement i Cricut Access™ (for nye abonnenter)
- 100 ferdige prosjektmaler på nettet
- Materialer til øvelseskutting

Kom i gang med Design Space™

Den kreative reisen begynner med Design Space, en kostnadsfri, brukervennlig designapp for Cricut smarte kuttemaskiner. Her kan du bla i tusenvis av bilder, prosjekter, og skrifttyper i Cricut-biblioteket. Eller design ditt eget prosjekt fra grunnen av.

Siden den er skybasert kan du starte på designet på datamaskinen og gjøre det ferdig på mobilenheten. For å designe uten en internettilforbindelse kan du enkelt laste ned dine skrifttyper og prosjekter, og så bruke disse mens du er frakoblet fra internett.

På cricut.com/setup kan du laste ned Design Space

Cricut Access™

Med et abonnement på Cricut Access får du tilgang til det stadig voksende biblioteket av bilder, skrifttyper og prosjekter, i tillegg til gratisbildene som er inkludert i Design Space. Den første måneden er gratis! Les mer på cricut.com/access





Oversikt over maskinen

- | | | |
|----------------------------|---------------------------|-------------------|
| 1. Inngang for mobil enhet | 5. Lager | 9. Pause-knapp |
| 2. Klemme A | 6. På-knapp | 10. USB-port |
| 3. Klemme B | 7. Last inn/Last ut-knapp | 11. Materialleder |
| 4. Oppbevaringsrom | 8. Start-knapp | |

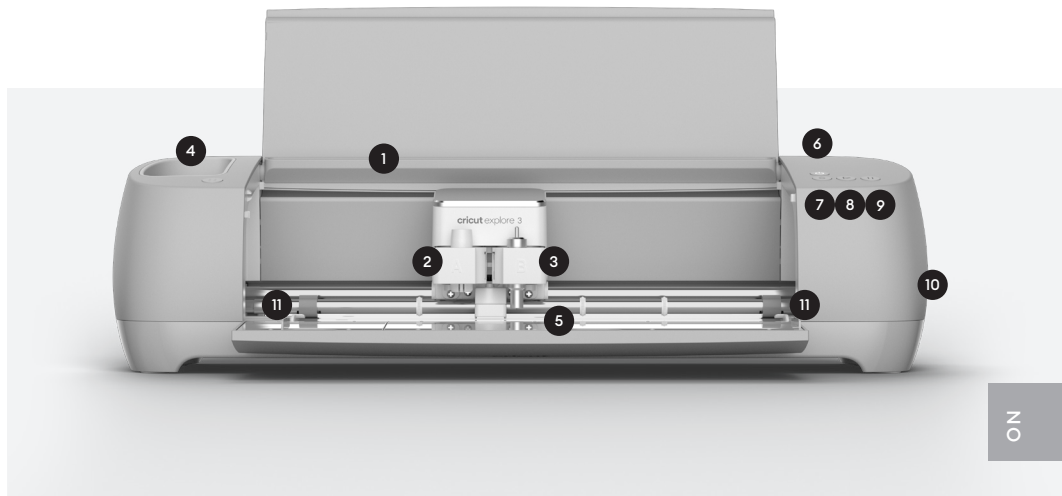

Se [cricut/more/more](#) for mer informasjon.





Sette inn Smart Materials™

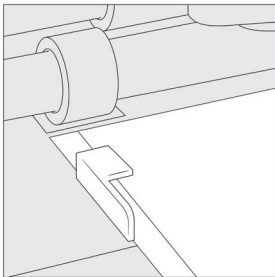

1. Sett materiale under materiallederen.

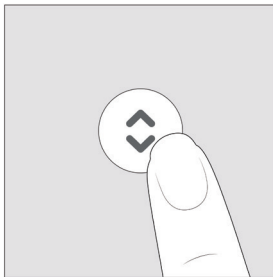

2. Hold det mot rollene samtidig som du trykker den blinkende Last inn/Last ut-knappen.

Last materialer inn på maskinmatten

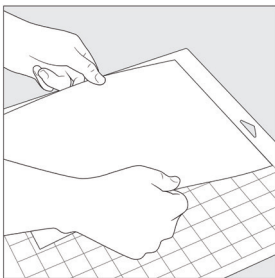

1. Fjern plastdekelet og rett inn materialet på maten. Bruk valsen for å jevne ut om du bruker stoff.

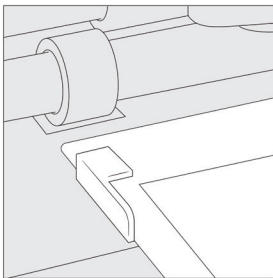

3. Når meldingen kommer, settes maten inn under materiallederen.

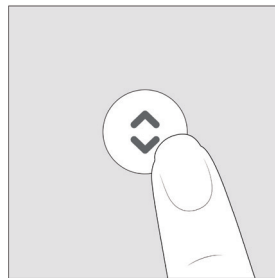

4. Hold maten mot rollene når du trykker på den blinkende Last inn/Last ut-knappen.





Endre verktøy

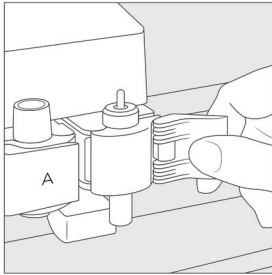

1. Åpne Klemme B, og ta ut verktøyet.

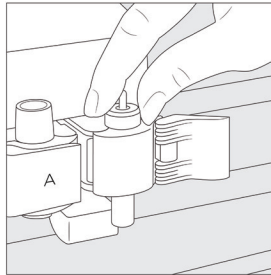

2. Fest sikkert det nye verktøyet.

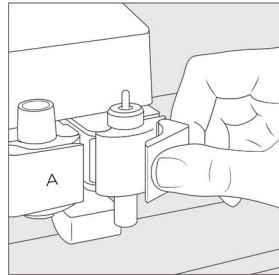

3. Lukk klemmen.

Vær forsiktig, og følg instruksjonene når du skifter blad. For instruksjoner, se blademballasje eller help.cricut.com/blades

NO

Se cricut/more/more for mer informasjon.



Medfølger

- Cricut Explore™ 3 -kone
- Premium ohutkärkinen terä + kotelo
- Tervetuloa-kortti
- Virta-adapteri
- USB-kaapeli
- Ilmainen Cricut Access™ -tilauksen kokeilu (uusille tilaajille)
- 100 heti toteutettavissa olevaa projektia verkossa
- Materiaalia leikkaamisen harjoitteluun

Design Space™-sovelluksen käytön aloittaminen

Aloita suunnittelu Design Space -sovelluksella. Design Space on helppokäyttöinen suunnittelusovellus älykkäille Cricut-leikkauskoneille. Sovelluksella voit selata tuhansia kuvia, projekteja ja kirjasmia Cricut-kirjastossa. Voit myös suunnitella oman projektisi alusta asti.

Sovellus on pilvipohjainen, joten voit aloittaa suunnittelun tietokoneella ja tehdä sen loppuun mobiililaitteella. Jos haluat suunnitella ilman internet-yhteyttä, lataa haluamasi kirjaset ja projektit offline-käyttöä varten.

Lataa Design Space -sovellus osoitteessa cricut.com/setup

Cricut Access™

Cricut Access-tilauksella saat Design Space -sovellukseen sisältyvien kuvien lisäksi käyttöön jatkuvasti kasvavan kirjaston, jossa on kuvia, kirjasmia ja projekteja. Ensimmäinen kuukausi on ilmainen! Lisätietoja on osoitteessa cricut.com/access





Koneen yleiskuvaus

- | | | |
|-----------------------------|--------------------------|--------------------------|
| 1. Paikka mobiililaitteelle | 5. Säilytystaso | 9. Keskeytyspainike |
| 2. Puristin A | 6. Virtapainike | 10. USB-portti |
| 3. Puristin B | 7. Syöttö-/poistopainike | 11. Materiaalin ohjaimet |
| 4. Säilytyslokero | 8. Aloituspainike | |

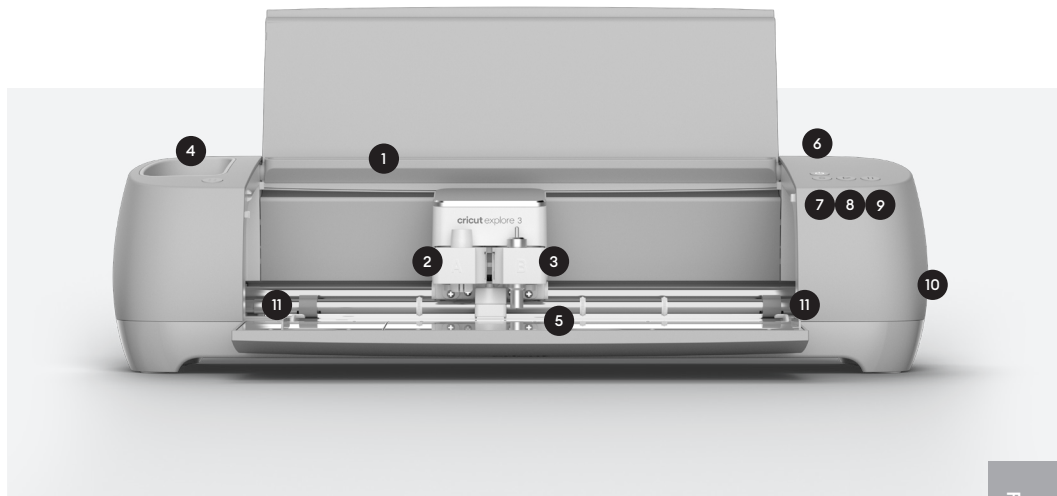

E

Lisätietoja on osoitteessa cricut.com/more





Smart Materials™ -materiaalien syöttö

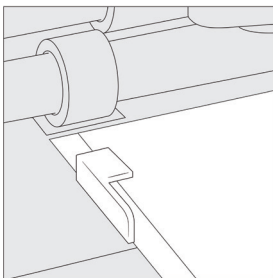

1. Asettele materiaali materiaalin ohjainten alle.

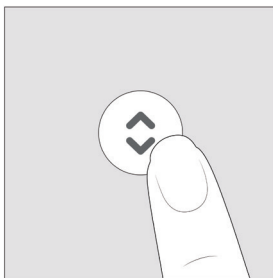

2. Pidä materiaalia rullia vastaan ja paina vilkkuvaa syöttö-/poistopainiketta.

Lataa konematto ja materiaali

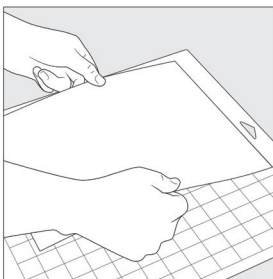

1. Poista muovipäällinen ja asettele materiaali matolle. Jos käytät kangasta, tasaista se käsitelällä.

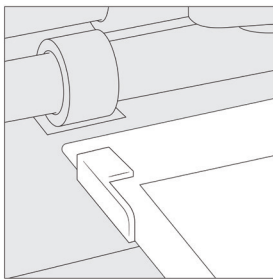

3. Aseta matto materiaalin ohjainten alle pyydettyäessä.

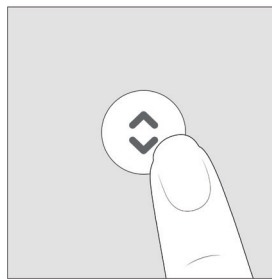

4. Pidä mattoa rullia vastaan ja paina vilkkuvaa syöttö-/poistopainiketta.





Työkalun vaihto

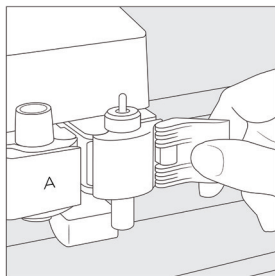

1. Avaa puristin B ja poista työkalu.

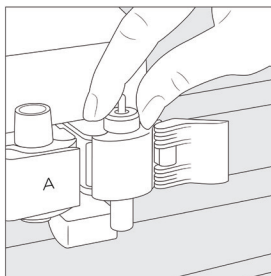

2. Aseta uusi työkalu tukevasti paikalleen.

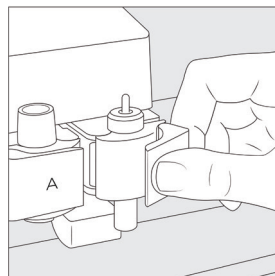

3. Sulje puristin.

Ole varovainen ja noudata ohjeita vaihdettaessa terää. Ohjeet ovat terän pakkauksessa tai help.cricut.com/blades



cricut[™]

