

Precision 3450 Small Form Factor

Service Manual



Notes, cautions, and warnings

 **NOTE:** A NOTE indicates important information that helps you make better use of your product.

 **CAUTION:** A CAUTION indicates either potential damage to hardware or loss of data and tells you how to avoid the problem.

 **WARNING:** A WARNING indicates a potential for property damage, personal injury, or death.

Working inside your computer

Topics:

- [Safety instructions](#)

Safety instructions

Prerequisites

Use the following safety guidelines to protect your computer from potential damage and to ensure your personal safety. Unless otherwise noted, each procedure included in this document assumes that the following conditions exist:

- You have read the safety information that shipped with your computer.
- A component can be replaced or, if purchased separately, installed by performing the removal procedure in reverse order.

About this task

⚠ WARNING: Before working inside your computer, read the safety information that shipped with your computer. For additional safety best practices information, see the [Regulatory Compliance Homepage](#)

⚠ CAUTION: Many repairs may only be done by a certified service technician. You should only perform troubleshooting and simple repairs as authorized in your product documentation, or as directed by the online or telephone service and support team. Damage due to servicing that is not authorized by Dell is not covered by your warranty. Read and follow the safety instructions that came with the product.

⚠ CAUTION: To avoid electrostatic discharge, ground yourself by using a wrist grounding strap or by periodically touching an unpainted metal surface at the same time as touching a connector on the back of the computer.

⚠ CAUTION: Handle components and cards with care. Do not touch the components or contacts on a card. Hold a card by its edges or by its metal mounting bracket. Hold a component such as a processor by its edges, not by its pins.

⚠ CAUTION: When you disconnect a cable, pull on its connector or on its pull-tab, not on the cable itself. Some cables have connectors with locking tabs; if you are disconnecting this type of cable, press in on the locking tabs before you disconnect the cable. As you pull connectors apart, keep them evenly aligned to avoid bending any connector pins. Also, before you connect a cable, ensure that both connectors are correctly oriented and aligned.

ⓘ NOTE: Disconnect all power sources before opening the computer cover or panels. After you finish working inside the computer, replace all covers, panels, and screws before connecting to the power source.

ⓘ NOTE: The color of your computer and certain components may appear differently than shown in this document.

⚠ CAUTION: System will shut down if side covers are removed while the system is running. The system will not power on if the side cover is removed.

Before working inside your computer

About this task

ⓘ NOTE: The images in this document may differ from your computer depending on the configuration you ordered.

Steps

1. Save and close all open files and exit all open applications.
2. Shut down your computer. Click **Start** > **Power** > **Shut down**.

 **NOTE:** If you are using a different operating system, see the documentation of your operating system for shut-down instructions.

3. Disconnect your computer and all attached devices from their electrical outlets.
4. Disconnect all attached network devices and peripherals, such as keyboard, mouse, and monitor from your computer.

 **CAUTION:** To disconnect a network cable, first unplug the cable from your computer and then unplug the cable from the network device.

5. Remove any media card and optical disc from your computer, if applicable.

Safety precautions

The safety precautions chapter details the primary steps to be taken before performing any disassembly instructions.

Observe the following safety precautions before you perform any installation or break/fix procedures involving disassembly or reassembly:

- Turn off the system and all attached peripherals.
- Disconnect the system and all attached peripherals from AC power.
- Disconnect all network cables, telephone, and telecommunications lines from the system.
- Use an ESD field service kit when working inside any tablet/notebook/desktop to avoid electrostatic discharge (ESD) damage.
- After removing any system component, carefully place the removed component on an anti-static mat.
- Wear shoes with non-conductive rubber soles to reduce the chance of getting electrocuted.

Standby power

Dell products with standby power must be unplugged before you open the case. Systems that incorporate standby power are essentially powered while turned off. The internal power enables the system to be remotely turned on (wake on LAN) and suspended into a sleep mode and has other advanced power management features.

Unplugging, pressing and holding the power button for 20 seconds should discharge residual power in the system board. Remove the battery from tablets/notebooks.

Bonding

Bonding is a method for connecting two or more grounding conductors to the same electrical potential. This is done through the use of a field service electrostatic discharge (ESD) kit. When connecting a bonding wire, ensure that it is connected to bare metal and never to a painted or non-metal surface. The wrist strap should be secure and in full contact with your skin, and ensure that you remove all jewelry such as watches, bracelets, or rings prior to bonding yourself and the equipment.

Electrostatic discharge—ESD protection

ESD is a major concern when you handle electronic components, especially sensitive components such as expansion cards, processors, memory DIMMs, and system boards. Very slight charges can damage circuits in ways that may not be obvious, such as intermittent problems or a shortened product life span. As the industry pushes for lower power requirements and increased density, ESD protection is an increasing concern.

Due to the increased density of semiconductors used in recent Dell products, the sensitivity to static damage is now higher than in previous Dell products. For this reason, some previously approved methods of handling parts are no longer applicable.

Two recognized types of ESD damage are catastrophic and intermittent failures.

- **Catastrophic** – Catastrophic failures represent approximately 20 percent of ESD-related failures. The damage causes an immediate and complete loss of device functionality. An example of catastrophic failure is a memory DIMM that has received a static shock and immediately generates a "No POST/No Video" symptom with a beep code emitted for missing or nonfunctional memory.

- **Intermittent** – Intermittent failures represent approximately 80 percent of ESD-related failures. The high rate of intermittent failures means that most of the time when damage occurs, it is not immediately recognizable. The DIMM receives a static shock, but the tracing is merely weakened and does not immediately produce outward symptoms related to the damage. The weakened trace may take weeks or months to melt, and in the meantime may cause degradation of memory integrity, intermittent memory errors, etc.

The more difficult type of damage to recognize and troubleshoot is the intermittent (also called latent or "walking wounded") failure.

Perform the following steps to prevent ESD damage:

- Use a wired ESD wrist strap that is properly grounded. The use of wireless anti-static straps is no longer allowed; they do not provide adequate protection. Touching the chassis before handling parts does not ensure adequate ESD protection on parts with increased sensitivity to ESD damage.
- Handle all static-sensitive components in a static-safe area. If possible, use anti-static floor pads and workbench pads.
- When unpacking a static-sensitive component from its shipping carton, do not remove the component from the anti-static packing material until you are ready to install the component. Before unwrapping the anti-static packaging, ensure that you discharge static electricity from your body.
- Before transporting a static-sensitive component, place it in an anti-static container or packaging.

ESD field service kit

The unmonitored Field Service kit is the most commonly used service kit. Each Field Service kit includes three main components: anti-static mat, wrist strap, and bonding wire.

Components of an ESD field service kit

The components of an ESD field service kit are:

- **Anti-Static Mat** – The anti-static mat is dissipative and parts can be placed on it during service procedures. When using an anti-static mat, your wrist strap should be snug and the bonding wire should be connected to the mat and to any bare metal on the system being worked on. Once deployed properly, service parts can be removed from the ESD bag and placed directly on the mat. ESD-sensitive items are safe in your hand, on the ESD mat, in the system, or inside a bag.
- **Wrist Strap and Bonding Wire** – The wrist strap and bonding wire can be either directly connected between your wrist and bare metal on the hardware if the ESD mat is not required, or connected to the anti-static mat to protect hardware that is temporarily placed on the mat. The physical connection of the wrist strap and bonding wire between your skin, the ESD mat, and the hardware is known as bonding. Use only Field Service kits with a wrist strap, mat, and bonding wire. Never use wireless wrist straps. Always be aware that the internal wires of a wrist strap are prone to damage from normal wear and tear, and must be checked regularly with a wrist strap tester in order to avoid accidental ESD hardware damage. It is recommended to test the wrist strap and bonding wire at least once per week.
- **ESD Wrist Strap Tester** – The wires inside of an ESD strap are prone to damage over time. When using an unmonitored kit, it is a best practice to regularly test the strap prior to each service call, and at a minimum, test once per week. A wrist strap tester is the best method for doing this test. If you do not have your own wrist strap tester, check with your regional office to find out if they have one. To perform the test, plug the wrist-strap's bonding-wire into the tester while it is strapped to your wrist and push the button to test. A green LED is lit if the test is successful; a red LED is lit and an alarm sounds if the test fails.
- **Insulator Elements** – It is critical to keep ESD sensitive devices, such as plastic heat sink casings, away from internal parts that are insulators and often highly charged.
- **Working Environment** – Before deploying the ESD Field Service kit, assess the situation at the customer location. For example, deploying the kit for a server environment is different than for a desktop or portable environment. Servers are typically installed in a rack within a data center; desktops or portables are typically placed on office desks or cubicles. Always look for a large open flat work area that is free of clutter and large enough to deploy the ESD kit with additional space to accommodate the type of system that is being repaired. The workspace should also be free of insulators that can cause an ESD event. On the work area, insulators such as Styrofoam and other plastics should always be moved at least 12 inches or 30 centimeters away from sensitive parts before physically handling any hardware components
- **ESD Packaging** – All ESD-sensitive devices must be shipped and received in static-safe packaging. Metal, static-shielded bags are preferred. However, you should always return the damaged part using the same ESD bag and packaging that the new part arrived in. The ESD bag should be folded over and taped shut and all the same foam packing material should be used in the original box that the new part arrived in. ESD-sensitive devices should be removed from packaging only at an ESD-protected work surface, and parts should never be placed on top of the ESD bag because only the inside of the bag is shielded. Always place parts in your hand, on the ESD mat, in the system, or inside an anti-static bag.
- **Transporting Sensitive Components** – When transporting ESD sensitive components such as replacement parts or parts to be returned to Dell, it is critical to place these parts in anti-static bags for safe transport.

ESD protection summary

It is recommended that all field service technicians use the traditional wired ESD grounding wrist strap and protective anti-static mat at all times when servicing Dell products. In addition, it is critical that technicians keep sensitive parts separate from all insulator parts while performing service and that they use anti-static bags for transporting sensitive components.

After working inside your computer

About this task

 **CAUTION:** Leaving stray or loose screws inside your computer may severely damage your computer.

Steps

1. Replace all screws and ensure that no stray screws remain inside your computer.
2. Connect any external devices, peripherals, or cables you removed before working on your computer.
3. Replace any media cards, discs, or any other parts that you removed before working on your computer.
4. Connect your computer and all attached devices to their electrical outlets.
5. Turn on your computer.

Disassembly and reassembly

Topics:

- Recommended tools
- Screw List
- Major components of your system
- Side cover
- Intrusion switch
- Front bezel
- Hard-drive assembly
- Hard-drive and optical-drive module
- Optical drive
- Solid-state drive
- WLAN card
- SD card reader - optional
- Expansion card
- Memory modules
- Heat sink
- Coin-cell battery
- Processor
- Power switch
- Power-supply unit
- System fan
- System board

Recommended tools

The procedures in this document may require the following tools:

- Phillips #0 screwdriver
- Phillips #1 screwdriver
- Philips #2 screwdriver
- Plastic scribe
- T-30 torx screwdriver

Screw List

The following table shows the screw list and the images for different components.

Table 1. Screw list







Component	Screw type	Quantity	Image
M.2 2230/2280 Solid-state drive	M2x3	1	
WLAN card	M2x3	1	
SD card reader	M6x32	2	

Table 1. Screw list (continued)

Component	Screw type	Quantity	Image
Support bracket	M6x32	2	
Power supply unit	M6x32	2	
System board	M2x4 6-32	1 5	 

Major components of your system

1. Side cover
2. Memory module
3. I/O panel
4. Fan and Heat-sink assembly
5. Processor
6. Solid-state drive
7. Power button
8. System board
9. Chassis
10. Front bezel
11. 3.5-inch Hard-drive
12. System fan
13. Graphics card
14. Optical drive (Optional)
15. Power-supply unit

Side cover

Removing the side cover

Prerequisites

1. Follow the procedure in [before working inside your computer](#).
 **NOTE:** Ensure that you remove the security cable from the security-cable slot (if applicable).

About this task

The following images indicate the location of the side cover and provides a visual representation of the removal procedure.

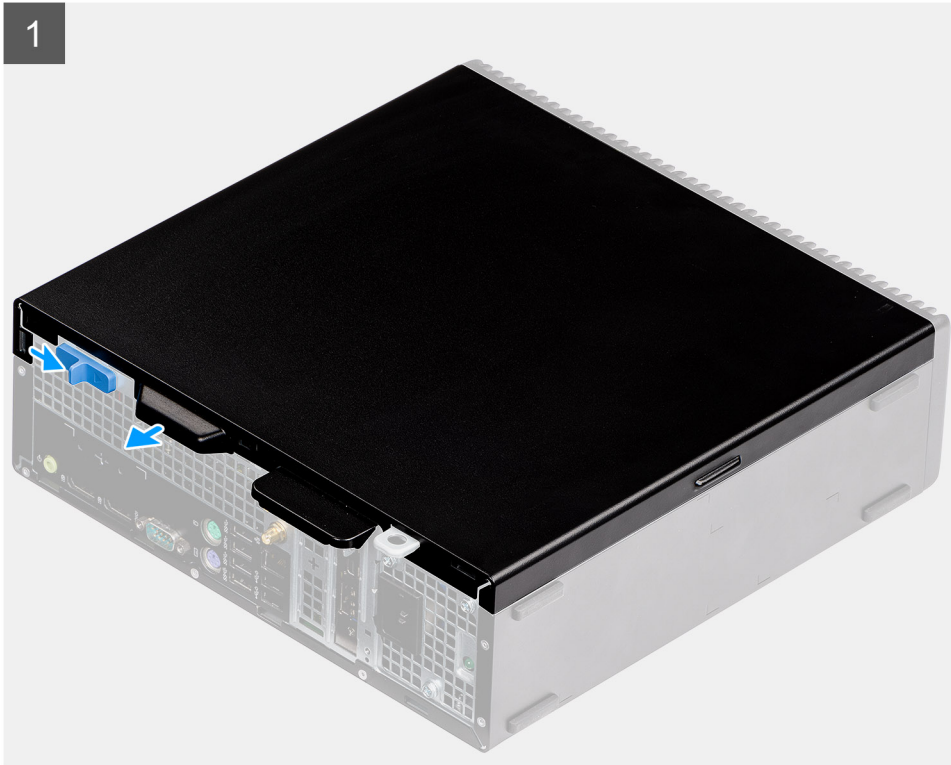

Steps

1. Slide the release latch to unlock the side cover.
2. Slide the side cover towards the back of the system.
3. Lift the side cover from the system.

Installing the side cover

Prerequisites

About this task

The following image indicates the location of the side panels and provides a visual representation of the installation procedure.

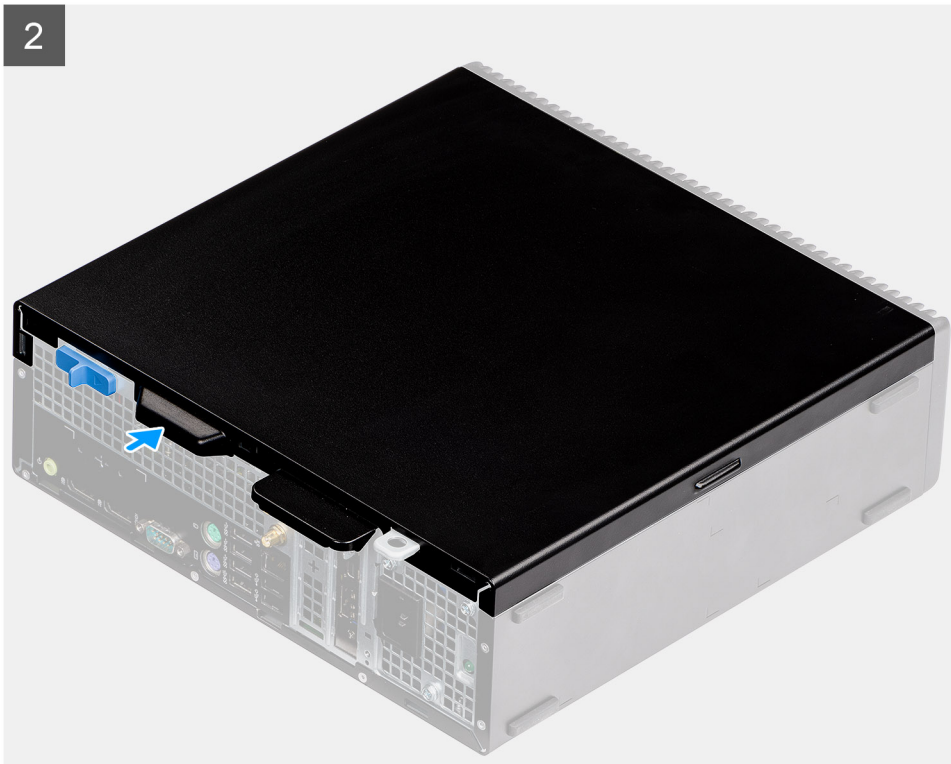

Steps

1. Place the side cover on your computer.
2. Slide the side cover towards the front of the system till you hear the release latch click.

Next steps

1. Follow the procedure in [after working inside your computer](#).

Intrusion switch

Removing the intrusion switch

Prerequisites

1. Follow the procedure in [Before working inside your computer](#).
2. Remove the [Side cover](#)

About this task

The following images indicate the location of the intrusion switch and provide a visual representation of the removal procedure.

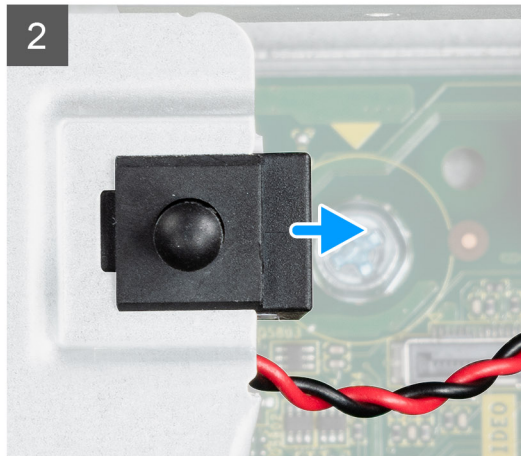
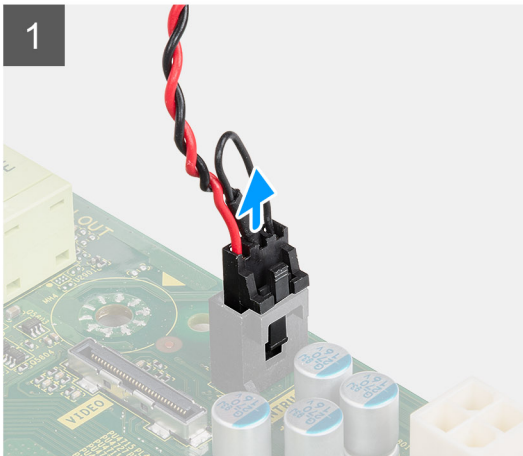

Steps

1. Disconnect the intrusion switch cable from the connector on the system board.
2. Slide the intrusion switch from the system .

Installing the intrusion switch

Prerequisites

About this task

The following image indicates the location of the intrusion switch and provides a visual representation of the installation procedure.

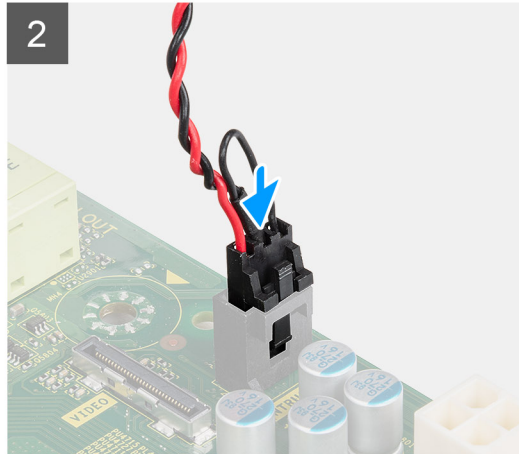
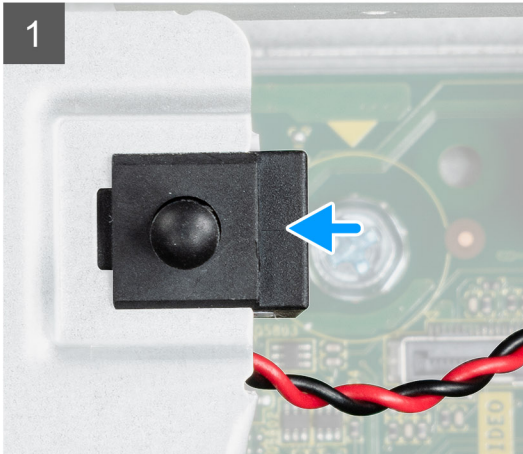
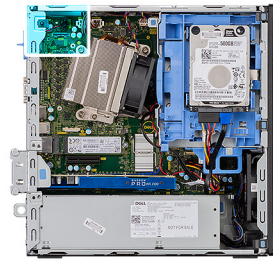

Steps

1. Slide the intrusion switch into the slot on the chassis.
2. Connect the intrusion switch cable to the connector on the system board. .

Next steps

1. Install the [Side cover](#)
2. Follow the procedure in [After working inside your computer](#).

Front bezel

Removing the front bezel

Prerequisites

1. Follow the procedure in [before working inside your computer](#).
2. Remove the [side cover](#).

About this task

The following images indicate the location of the front bezel and provide a visual representation of the removal procedure.

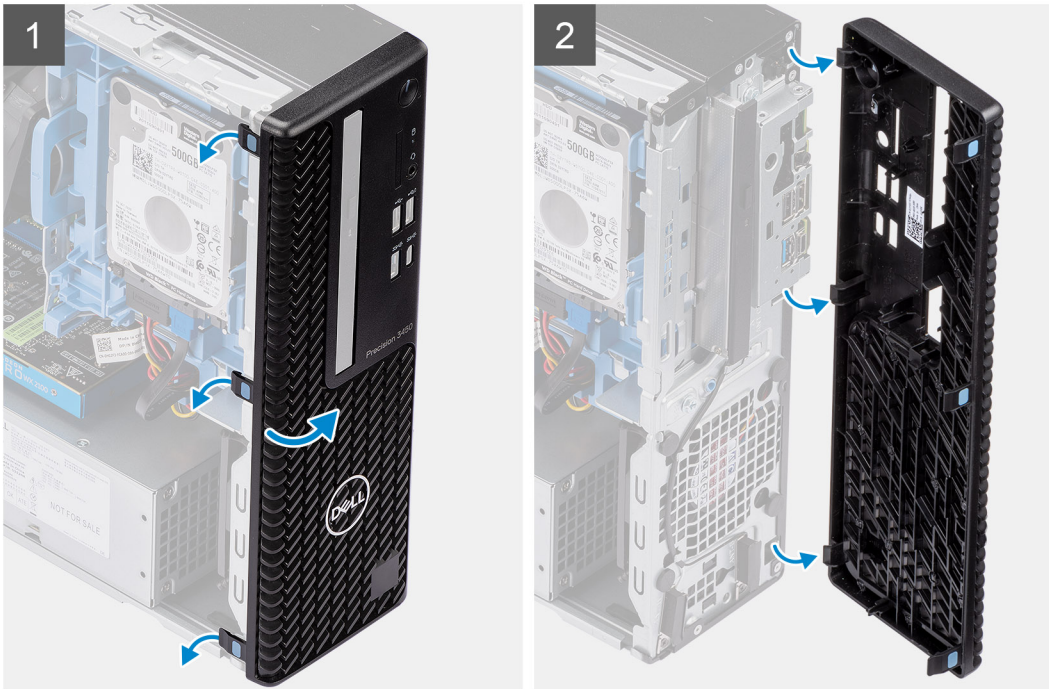

Steps

1. Pry the retention tabs to release the front bezel from the system.
2. Rotate and remove the front bezel from the system.

Installing the front bezel

Prerequisites

About this task

The following image indicates the location of the front bezel and provides a visual representation of the installation procedure.

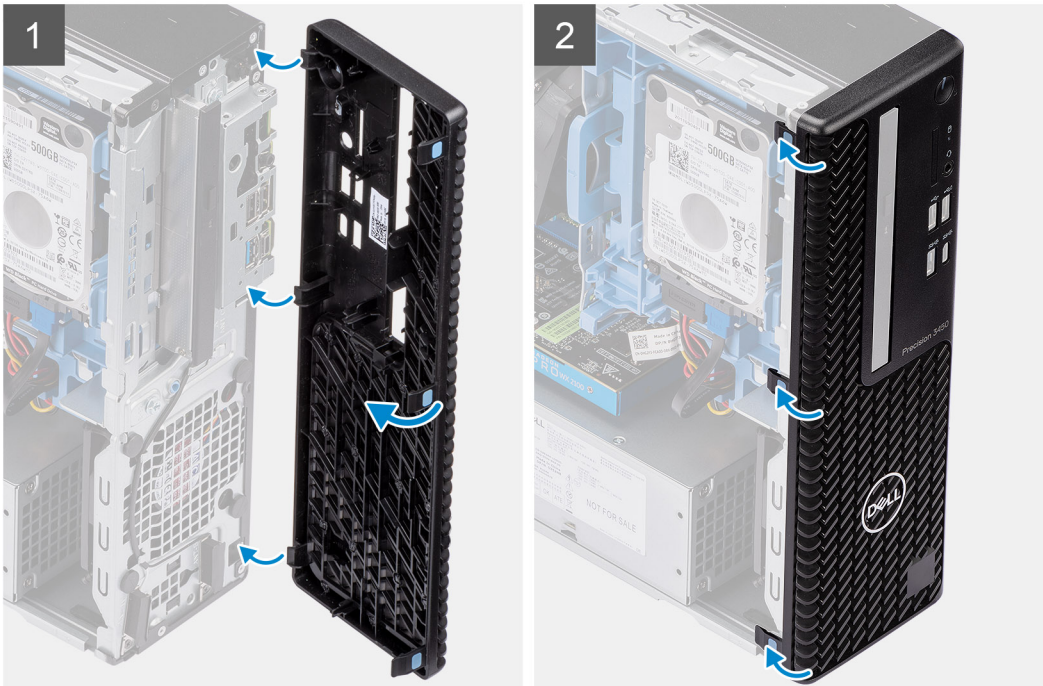
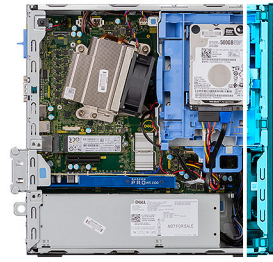

Steps

1. Align the bezel and insert the retention tabs on the bezel into the slots on the system.
2. Press the bezel until the retention tabs click into place.

Next steps

1. Install the [side cover](#).
2. Follow the procedure in [after working inside your computer](#).

Hard-drive assembly

Removing the 2.5 in. hard-disk drive assembly

Prerequisites

1. Follow the procedure in [before working inside your computer](#).
2. Remove the [side cover](#).
3. Remove the [front bezel](#).

About this task

The following images indicate the location of the 2.5 in. hard-disk drive assembly and provide a visual representation of the removal procedure.

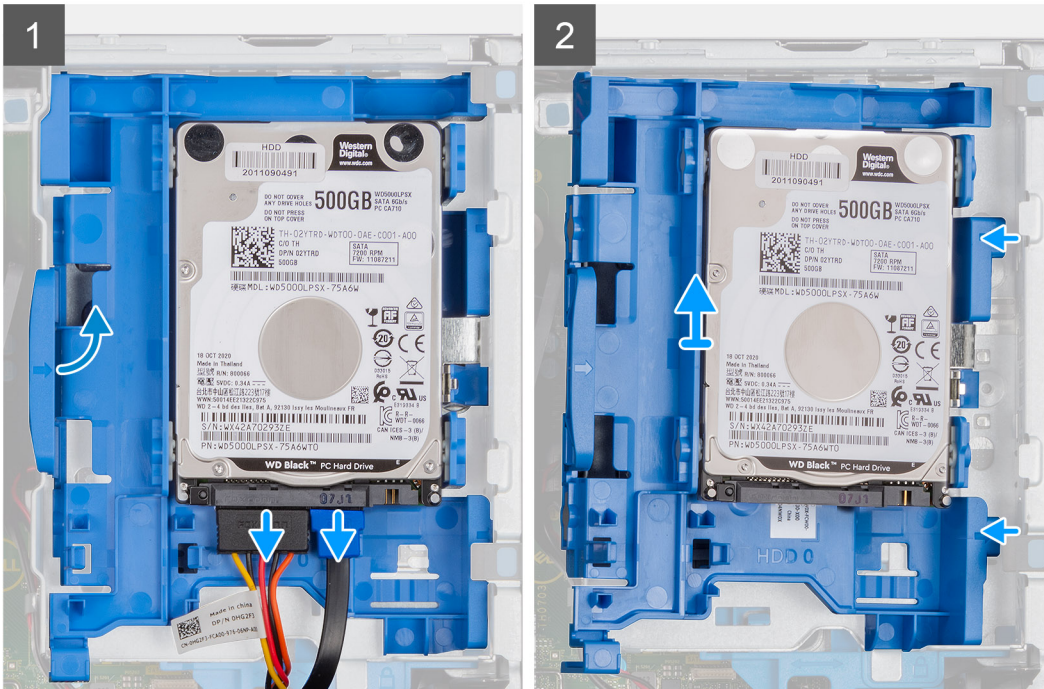
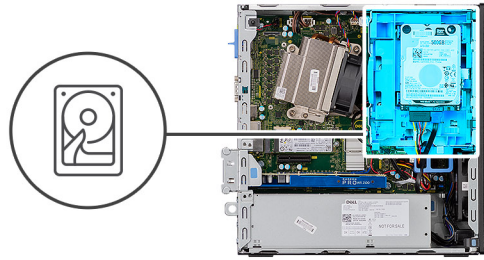

Steps

1. Disconnect the hard-disk drive data cable and power cable from the connectors on the hard-disk drive.
2. Push the release tab and slightly lift the hard-disk drive assembly.
3. Release the hard-disk drive assembly from the notch and slide the hard-disk drive assembly out.

NOTE: Note the orientation of the hard-disk drive so that you can replace it correctly.

Removing the hard-disk drive bracket

Prerequisites

1. Follow the procedure in [before working inside your computer](#).
2. Remove the [side cover](#).
3. Remove the [front bezel](#).
4. Remove the [2.5 in. hard-disk drive](#).

About this task

The following images indicate the location of the hard-disk drive bracket and provide a visual representation of the removal procedure.

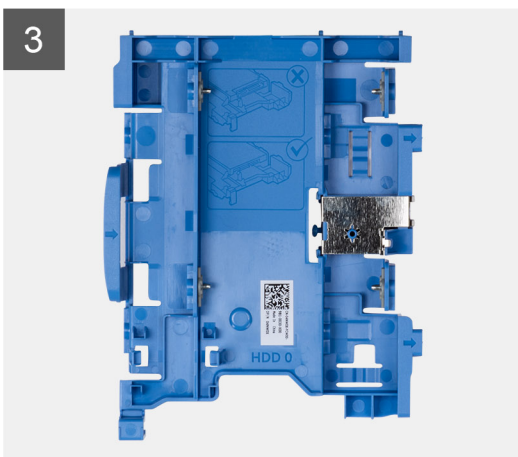
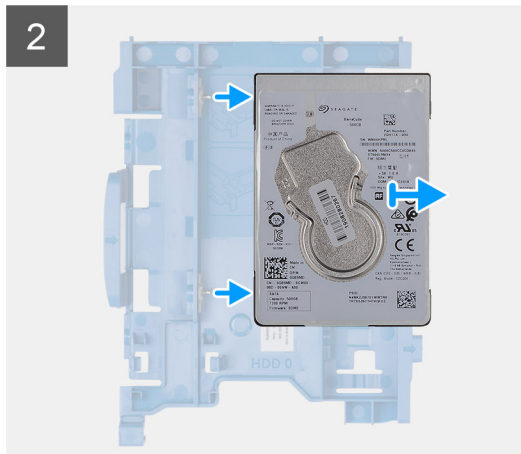
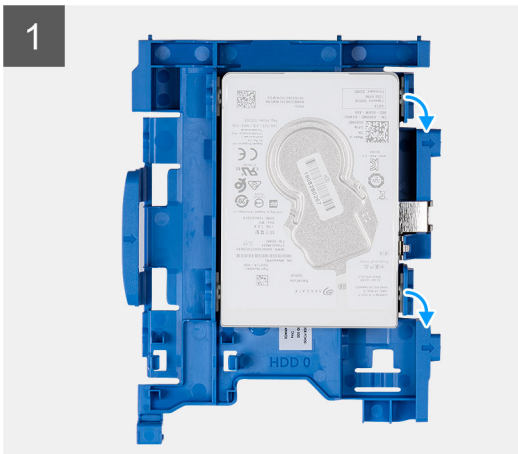

Steps

1. Pull one side of the hard-disk drive bracket to disengage the pins on the bracket from the slots on the drive.
2. Slide the hard-disk drive out of the bracket
3. Hard-disk drive bracket for the 2.5 in. hard-disk drive.
4. 2.5 in. hard-disk drive.

Installing the hard-disk drive bracket

Prerequisites

About this task

The following image indicates the location of the hard-disk drive bracket and provides a visual representation of the installation procedure.

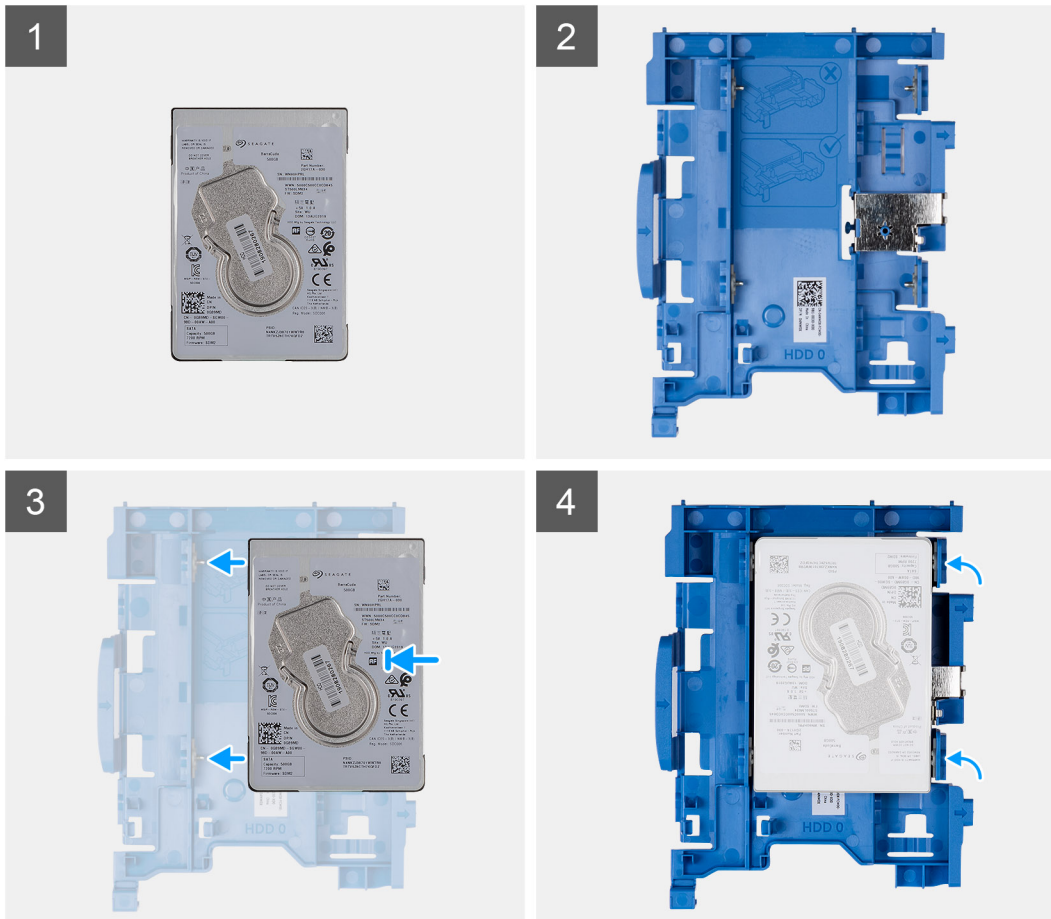

Steps

1. 2.5 in. hard-disk drive.
2. Hard-disk drive bracket for the 2.5 in. hard-disk drive.
3. Align and insert the pins on the drive bracket with the slots on the hard-disk drive.
4. 2.5 in. hard-disk drive assembly.

Next steps

1. Install the [2.5 in. hard-disk drive assembly](#).
2. Install the [front bezel](#).
3. Install the [side cover](#).
4. Follow the procedure in [after working inside your computer](#).

Installing the 2.5 in. hard-disk drive assembly

Prerequisites

About this task

The following image indicates the location of the 2.5 in. hard-disk drive and provides a visual representation of the installation procedure.

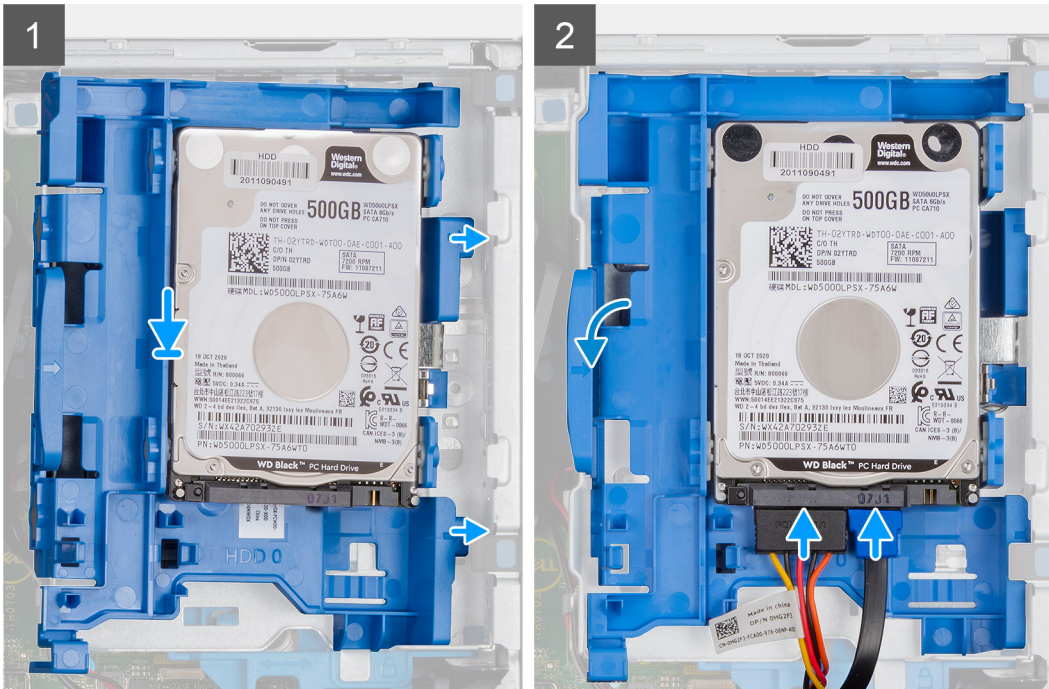
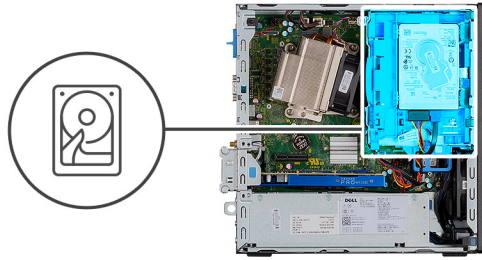

Steps

1. Insert the hard-disk drive assembly into the slot on the system and slide the hard-disk drive assembly down.
2. Press down the hard-disk drive assembly, until it clicks into place.
3. Connect the power cable and hard-disk drive cable to the connectors on the hard-disk drive.

Next steps

1. Install the [front bezel](#).
2. Install the [side cover](#).
3. Follow the procedure in [after working inside your computer](#).

Hard-drive and optical-drive module

Removing the hard-disk drive and optical-disk drive module

Prerequisites

1. Follow the procedure in [Before working inside your computer](#).
2. Remove the [Side cover](#)
3. Remove the [Front bezel](#)

About this task

The following images indicate the location of the hard-disk drive and optical-disk drive module and provide a visual representation of the removal procedure.

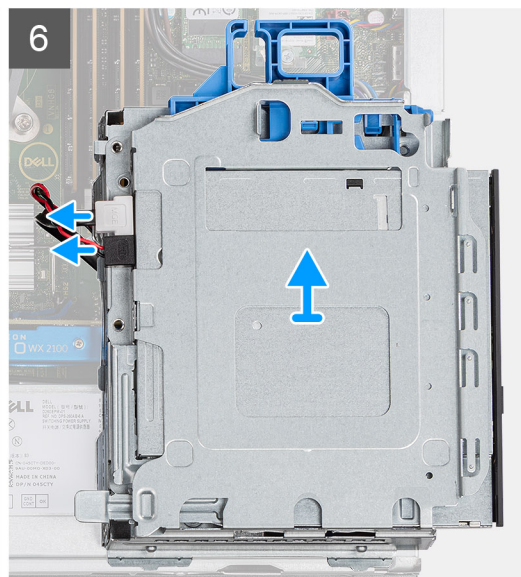
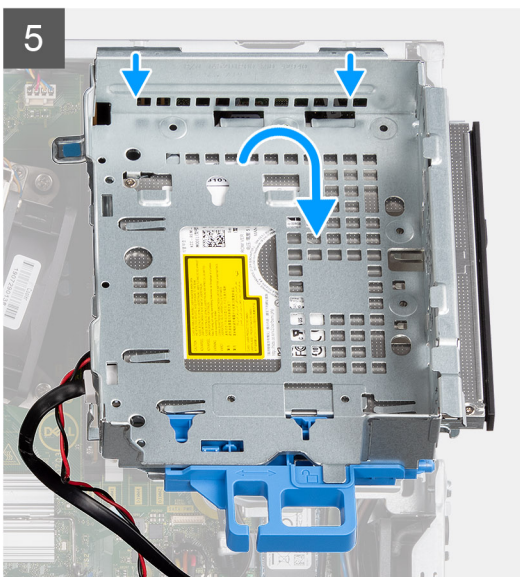
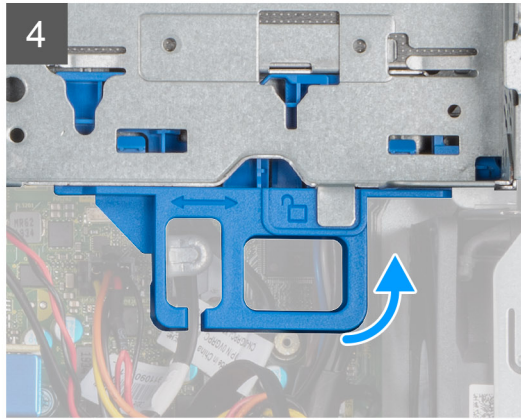
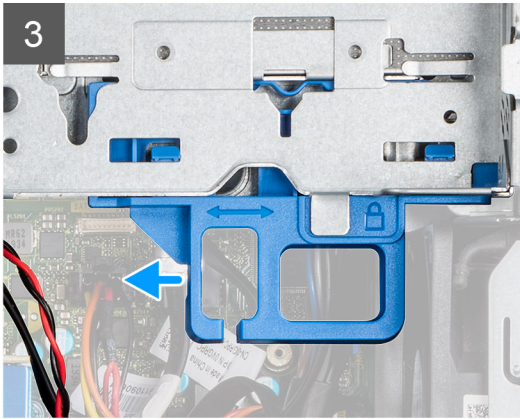
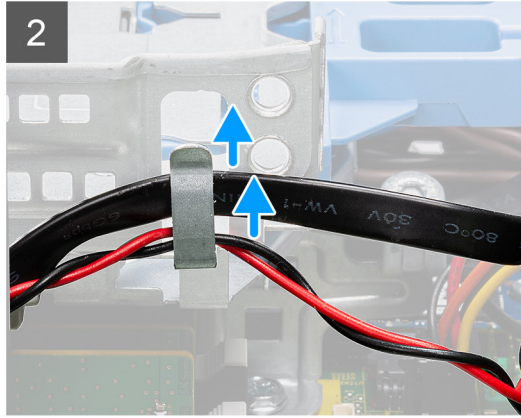
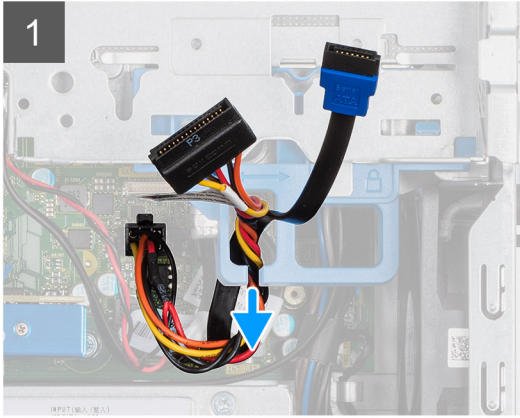

Steps

1. Remove the hard-disk drive power cable and the SATA cable through the recess in the release latch.

2. Unroute the optical-disk drive cable and the hard-disk drive cable from the retention clip on the hard-disk drive and optical-disk drive module.
3. Slide the release latch to unlock the hard-disk drive and optical-disk drive module.
4. Holding the release latch lift the hard-disk drive and optical-disk drive module.
5. Lift the hard-disk drive and optical-disk drive module and slide it out of the slot.
6. Flip the hard-disk drive and optical-disk drive module to disconnect the optical-disk drive data and power cables.

Installing the hard-disk drive and optical-disk drive module

Prerequisites

About this task

The following image indicates the location of the hard-disk drive and optical-disk drive module and provides a visual representation of the installation procedure.

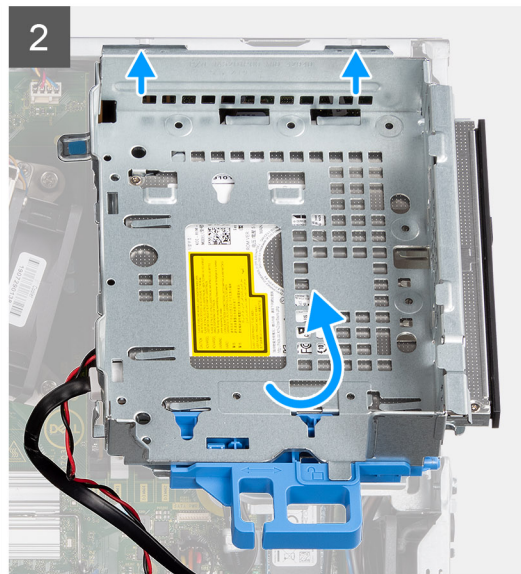
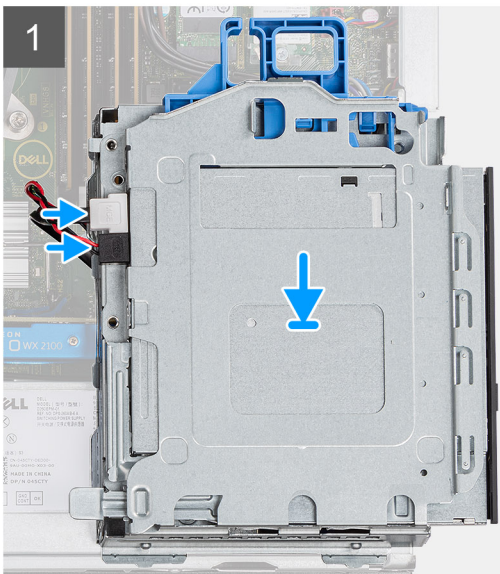
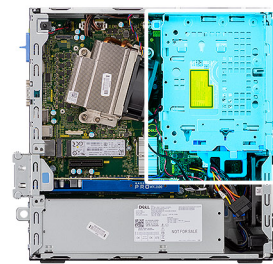

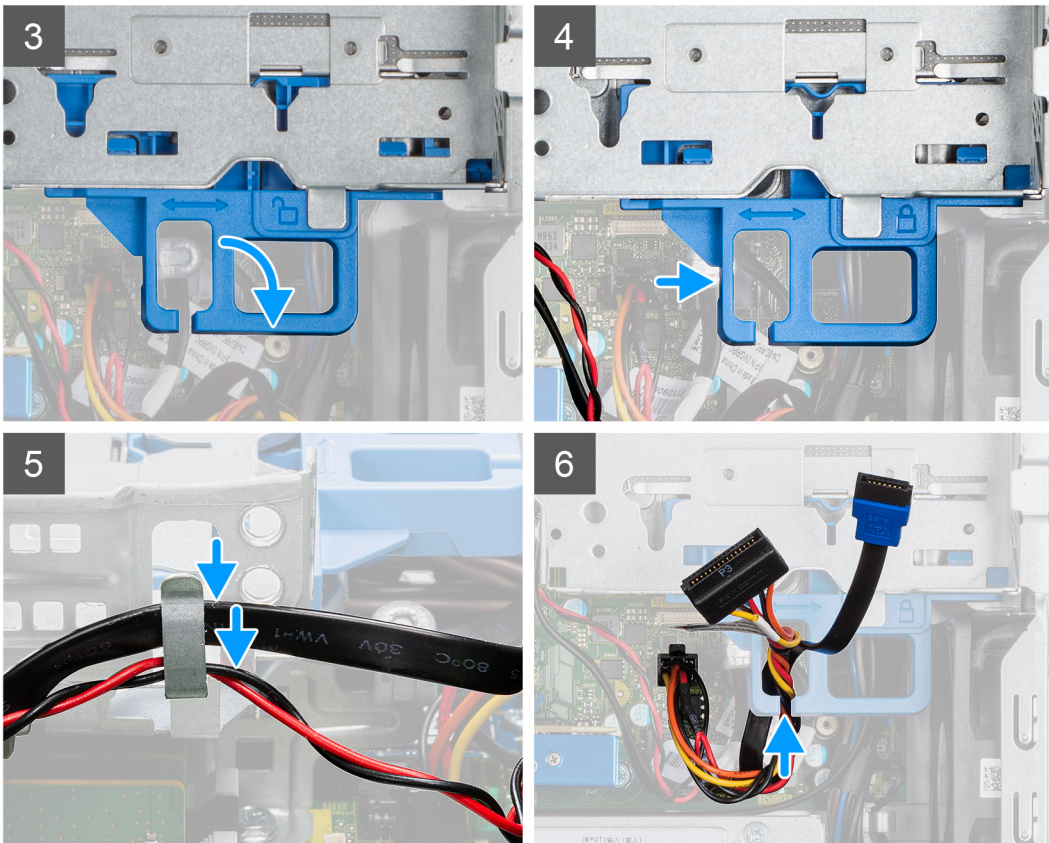

Steps

1. Connect the optical-drive data and power cable to the connectors on the optical-drive and flip the hard-disk drive and optical-disk drive module.
2. Insert the tabs on the hard-disk drive and optical-disk drive module into the slot on the system at an angle.
3. Lower the hard-disk drive and optical-disk drive module into the slot.
4. Slide the release latch to lock the hard-disk drive and optical-disk drive module.
5. Reroute the hard-disk drive power cable and SATA cable through the retention clips on the hard-disk drive and optical-disk drive module.
6. Reroute the hard-disk drive power cable and the SATA cable through the recess on the release tab.

Next steps

1. Install the [Front bezel](#)
2. Install the [Side cover](#)
3. Follow the procedure in [After working inside your computer](#).

Optical drive

Removing the slim optical-drive

Prerequisites

1. Follow the procedure in [Before working inside your computer](#).
2. Remove the [Side cover](#)
3. Remove the [Front bezel](#)

About this task

The following images indicate the location of the slim optical-drive and provide a visual representation of the removal procedure.

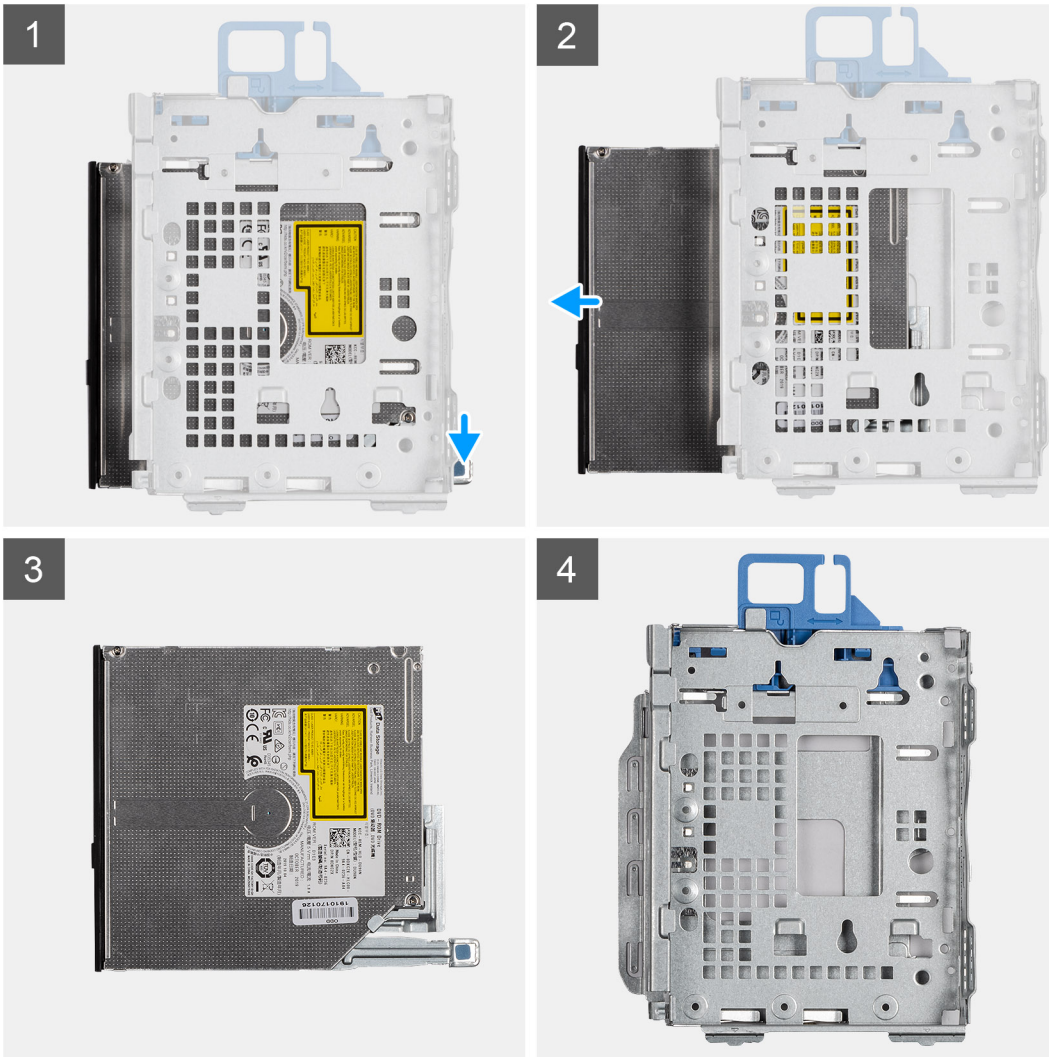

Steps

1. Press the release tab on the optical-drive/ hard-drive module.
2. Slide the optical-drive out of the optical-drive/ hard-drive module.
3. Optical-drive unit.
4. Optical-drive/ hard-drive module.

Installing the slim optical-drive

Prerequisites

About this task

The following image indicates the location of the slim optical-drive and provides a visual representation of the installation procedure.

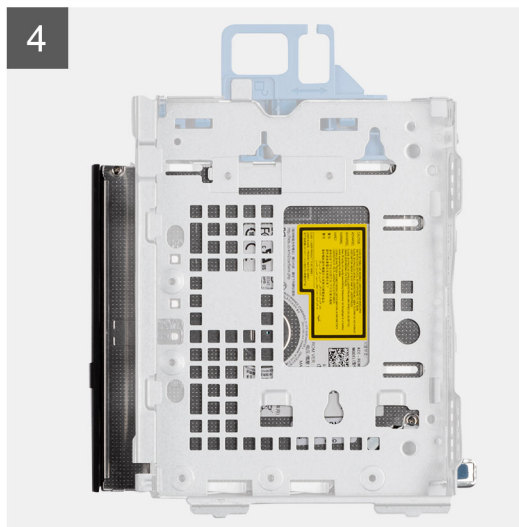
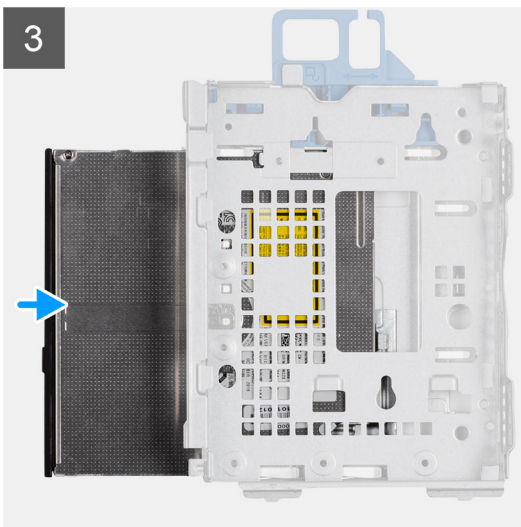
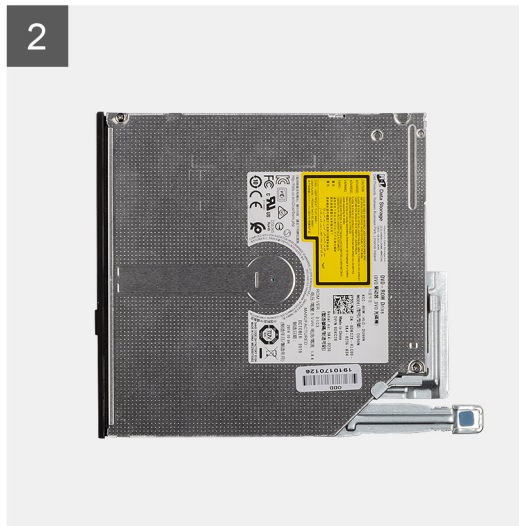

Steps

1. Optical drive/ hard drive module.
2. Optical drive unit.
3. Insert the optical drive into the optical drive/ hard drive module.
4. Press the Optical drive unit until it clicks in place.

Next steps

1. Install the [Front bezel](#)
2. Install the [Side cover](#)
3. Follow the procedure in [After working inside your computer](#).

Solid-state drive

Removing the M.2 2230 PCIe solid-state drive

Prerequisites

1. Follow the procedure in [before working inside your computer](#).
2. Remove the [side cover](#).
3. Remove the [front bezel](#).

4. Remove the 2.5 in. hard drive assembly.

About this task

The following images indicate the location of the solid-state drive and provide a visual representation of the removal procedure.



1x
M2x3

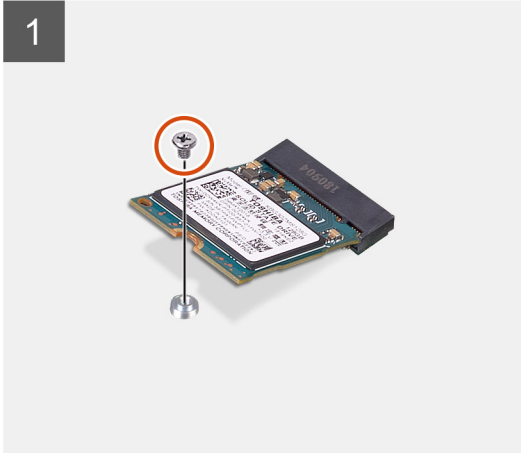
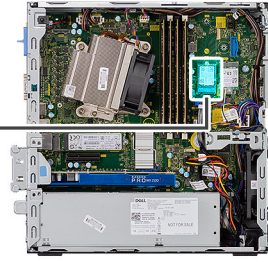

Steps

1. Remove the screw (M2x3) that secures the solid-state drive to the system board.
2. Slide and lift the solid-state drive off the system board.

Installing the M.2 2230 PCIe solid-state drive

Prerequisites

About this task

The following image indicates the location of the solid-state drive and provides a visual representation of the installation procedure.



1x
M2x3

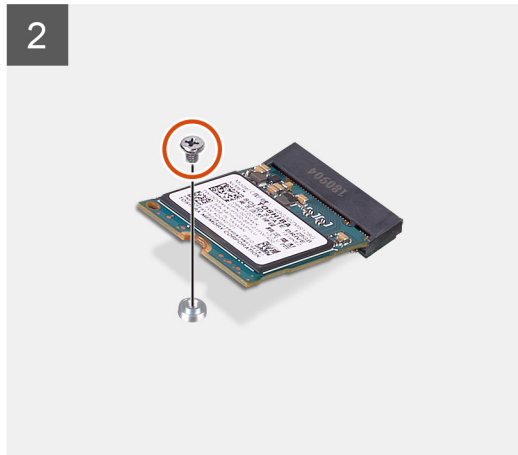
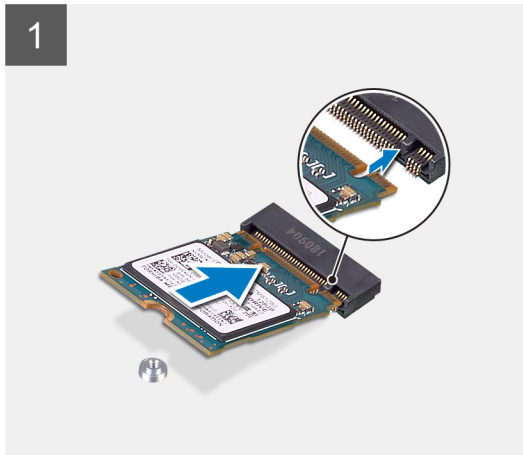
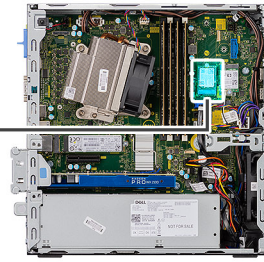

Steps

1. Align the notch on the solid-state drive with the tab on the solid-state drive connector.
2. Insert the solid-state drive at a 45-degree angle into the connector on the system board.
3. Replace the screw (M2x3) that secures the M.2 2230 PCIe solid-state drive to the system board.

Next steps

1. Install the [2.5 in. hard drive assembly](#).
2. Install the [front bezel](#).
3. Install the [side cover](#).
4. Follow the procedure in [after working inside your computer](#).

Removing the M.2 2280 PCIe solid-state drive

Prerequisites

1. Follow the procedure in [before working inside your computer](#).
2. Remove the [side cover](#).
3. Remove the [front bezel](#).
4. Remove the [2.5 in. hard drive assembly](#).

About this task

The following images indicate the location of the solid-state drive and provide a visual representation of the removal procedure.



1x
M2x3

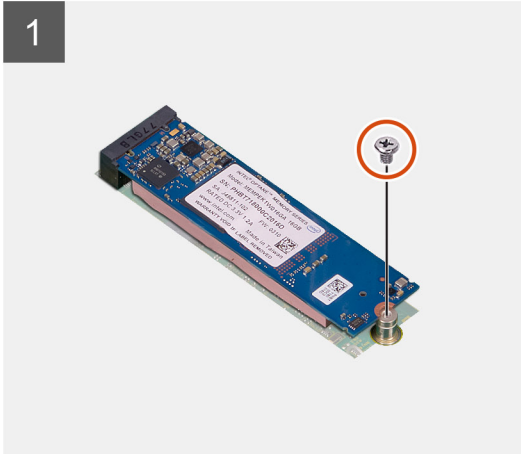
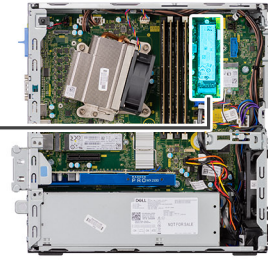

Steps

1. Remove the screw (M2x3) that secures the solid-state drive to the system board.
2. Slide and lift the solid-state drive off the system board.

Installing the M.2 2280 PCIe solid-state drive

Prerequisites

About this task

The following image indicates the location of the solid-state drive and provides a visual representation of the installation procedure.



1x
M2x3

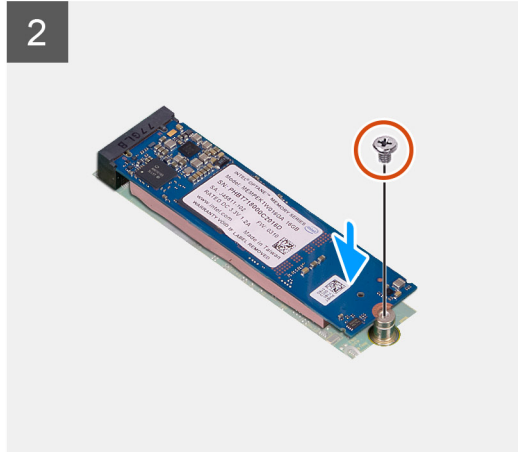
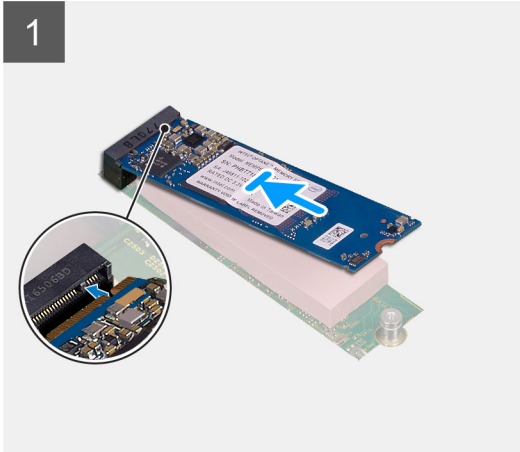
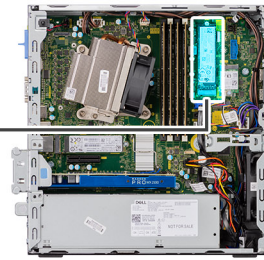

Steps

1. Align the notch on the solid-state drive with the tab on the solid-state drive connector.
2. Insert the solid-state drive at a 45-degree angle into the connector on the system board.
3. Replace the screw (M2x3) that secures the M.2 2280 PCIe solid-state drive to the system board.

Next steps

1. Install the [2.5 in. hard drive assembly](#).
2. Install the [front bezel](#).
3. Install the [side cover](#).
4. Follow the procedure in [after working inside your computer](#).

WLAN card

Removing the WLAN card

Prerequisites

1. Follow the procedure in [before working inside your computer](#).
2. Remove the [side cover](#).
3. Remove the [front bezel](#).
4. Remove the [2.5 in. hard drive assembly](#).

About this task

The following images indicate the location of the wireless card and provide a visual representation of the removal procedure.



1x
M2x3

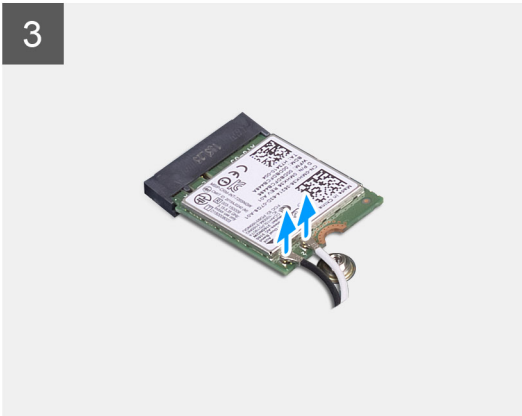
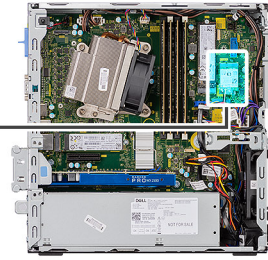

Steps

1. Remove the (M2x3) screw that secures the WLAN bracket and WLAN card to the system board.
2. Slide and lift the WLAN card bracket away from the WLAN card.
3. Disconnect the antenna cables from the WLAN card.
4. Slide and remove the WLAN card from the connector on the system board.

Installing the WLAN card

Prerequisites

About this task

The following image indicates the location of the wireless card and provides a visual representation of the installation procedure.



1x
M2x3

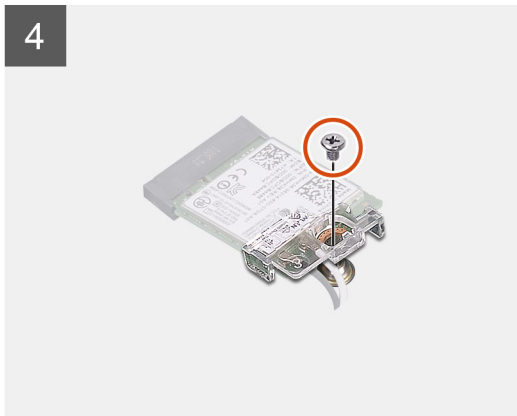
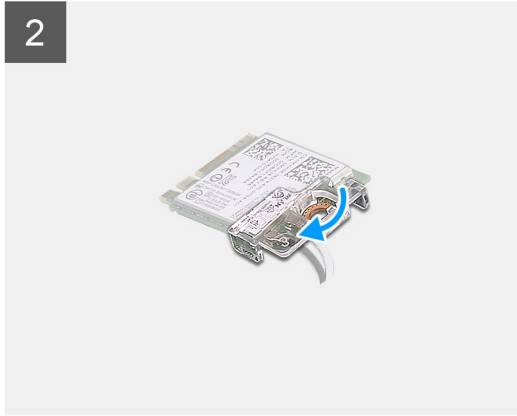
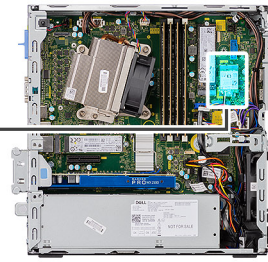

Steps

1. Connect the antenna cables to the WLAN card.
The following table provides the antenna-cable color scheme for the WLAN card of your computer.

Table 2. Antenna-cable color scheme

Connectors on the wireless card	Antenna-cable color
Main (white triangle)	White
Auxiliary (black triangle)	Black

2. Place the WLAN card bracket to secure the antenna cables.
3. Align the notch on the WLAN card with the tab on the WLAN-card slot and insert it into the connector on the system board.
4. Replace the (M2x3) screw to secure the WLAN card bracket and WLAN card to the system board.

Next steps

1. Install the [2.5 in. hard drive assembly](#).
2. Install the [front bezel](#).
3. Install the [side cover](#).
4. Follow the procedure in [after working inside your computer](#).

SD card reader - optional

Removing the SD card reader

Prerequisites

1. Follow the procedure in [Before working inside your computer](#).
2. Remove the [Side cover](#)
3. Remove the [Front bezel](#)
4. Remove the [Hard drive assembly](#)
5. Remove the [Optical drive assembly](#)

About this task

The following images indicate the location of the graphics card and provide a visual representation of the removal procedure.



2x
M6x32

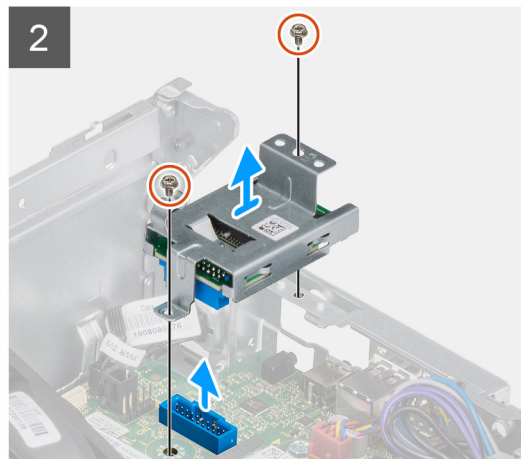
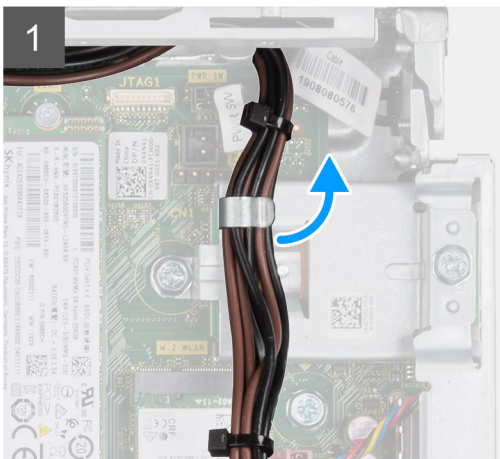

Steps

1. Unroute the power supply cables from the retention clip on the SD card reader.
2. Remove the two screws (M6X32) and lift the SD card reader from the chassis.

Installing the SD card reader

Prerequisites

About this task

The following image indicates the location of the SD card reader and provides a visual representation of the installation procedure.



2x
M6x32

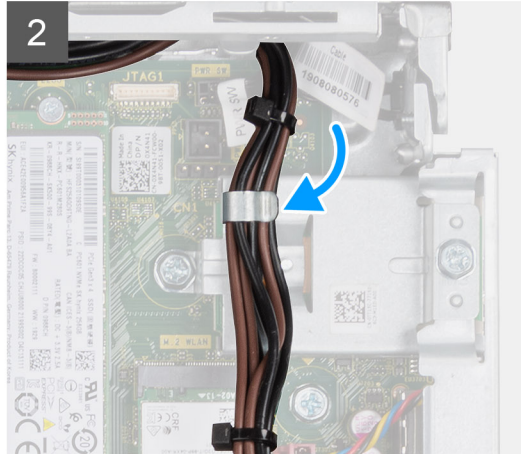
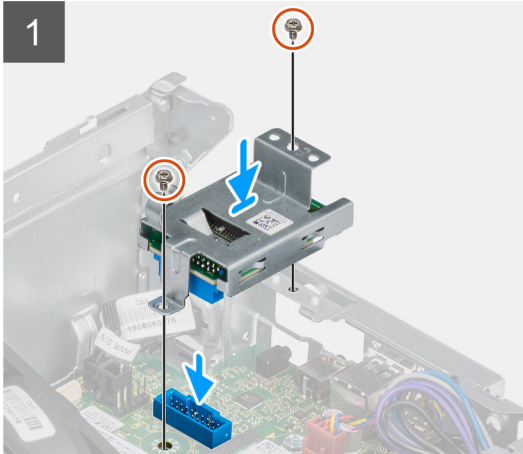

Steps

1. Align the SD card reader with the screw holes on the system board and replace the two screws (M6X32).
2. Route the power supply cables through the retention clip on the SD card reader.

Next steps

1. Install the [Optical drive assembly](#)
2. Install the [Hard drive assembly](#)
3. Install the [Front bezel](#)
4. Install the [Side cover](#)
5. Follow the procedure in [After working inside your computer](#).

Expansion card

Removing the expansion card

Prerequisites

1. Follow the procedure in [Before working inside your computer](#).
2. Remove the [Side cover](#)

About this task

The following images indicate the location of the expansion card and provide a visual representation of the removal procedure.

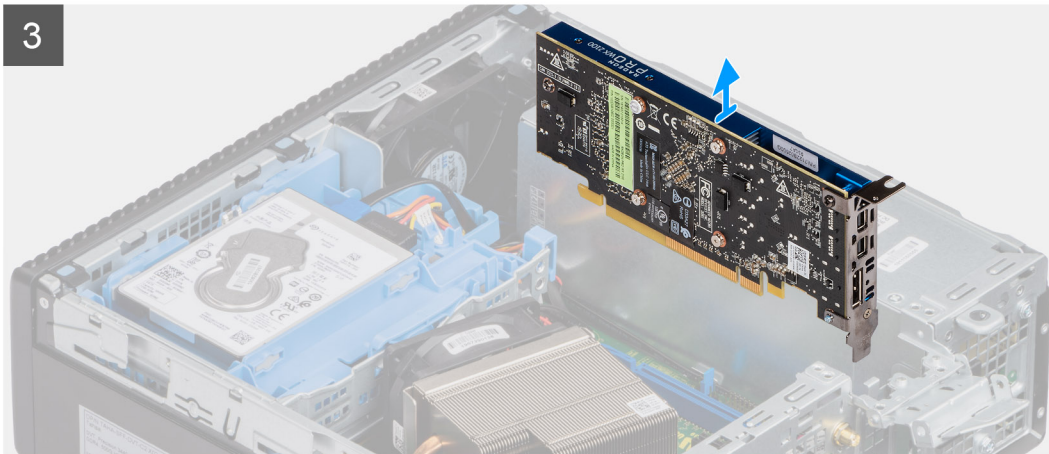
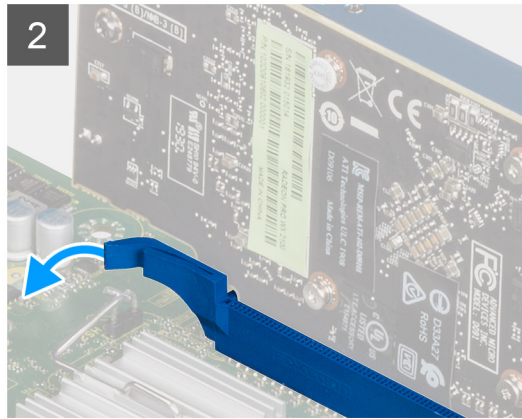
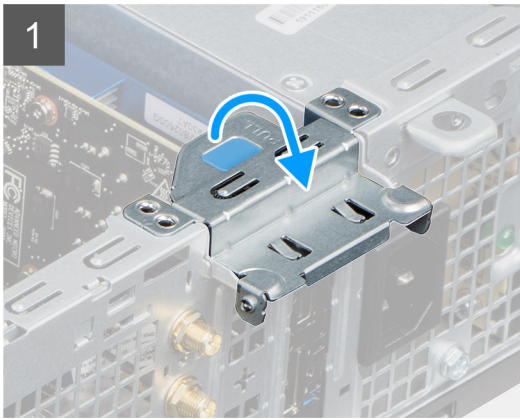

Steps

1. Pull the metal tab to open the expansion card latch.
2. Pull the release tab at the base of the expansion card.
3. Lift the expansion card away from the connector on the system board.

Installing the expansion card

Prerequisites

About this task

The following image indicates the location of the expansion card and provides a visual representation of the installation procedure.

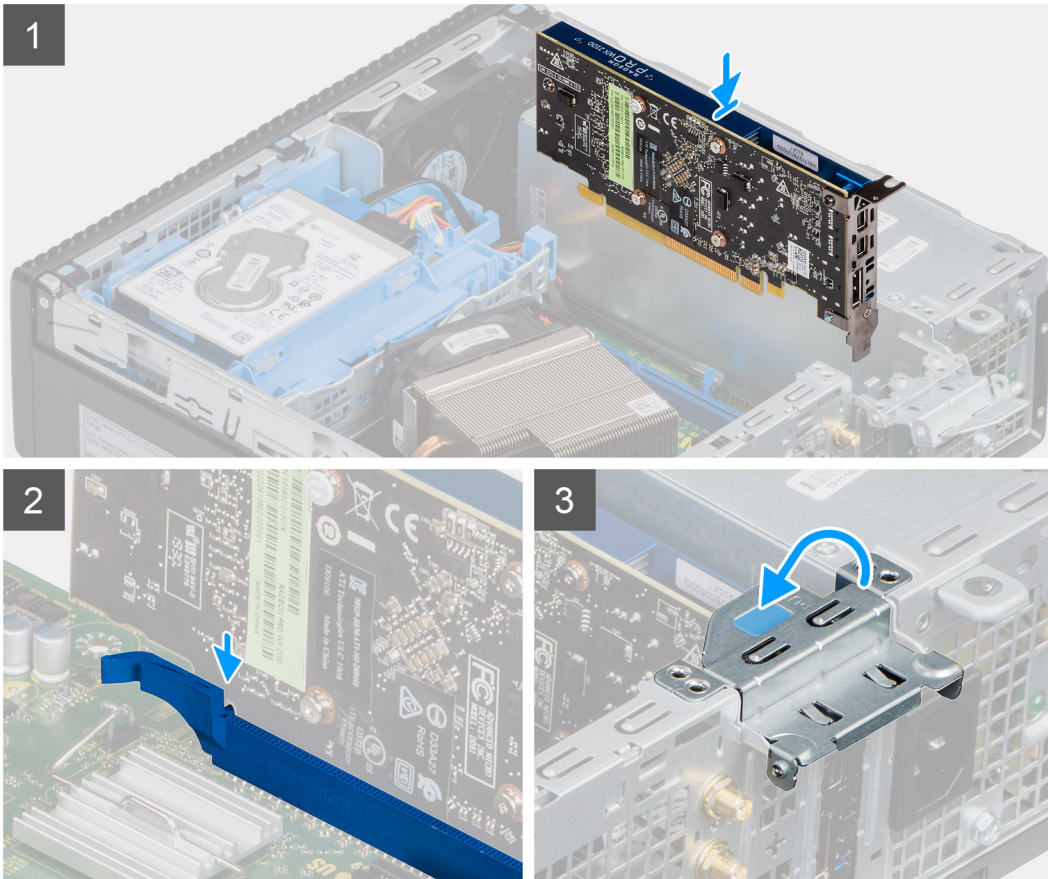

Steps

1. Align the notch on the expansion card with the connector on the system board.
2. Place the card in the connector and press down firmly. Ensure that the card is firmly seated.
3. Close the expansion card latch and press it until it clicks into place.

Next steps

1. Install the [Side cover](#)
2. Follow the procedure in [After working inside your computer](#).

Memory modules

Removing the memory modules

Prerequisites

1. Follow the procedure in [before working inside your computer](#).
2. Remove the [side cover](#).

3. Remove the [front bezel](#).
4. Remove the [2.5 in. hard drive assembly](#).
5. Remove the [hard-disk drive and optical-disk drive module](#).

CAUTION: To prevent damage to the memory module, hold the memory module by the edges. Do not touch the components on the memory module

About this task

The following images indicate the location of the memory modules and provide a visual representation of the removal procedure.

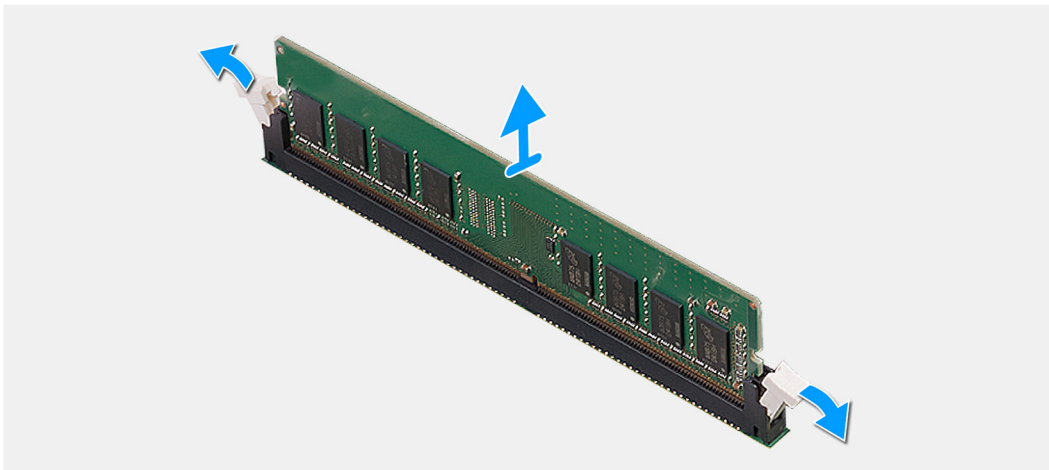
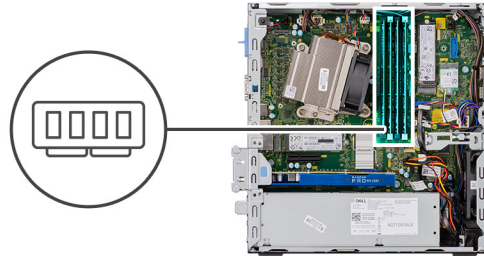

Steps

1. Pull the securing clips from the memory module until the memory module pops up.
2. Remove the memory module from the memory-module slot.

Installing the memory modules

Prerequisites

About this task

The following image indicates the location of the memory modules and provides a visual representation of the installation procedure.

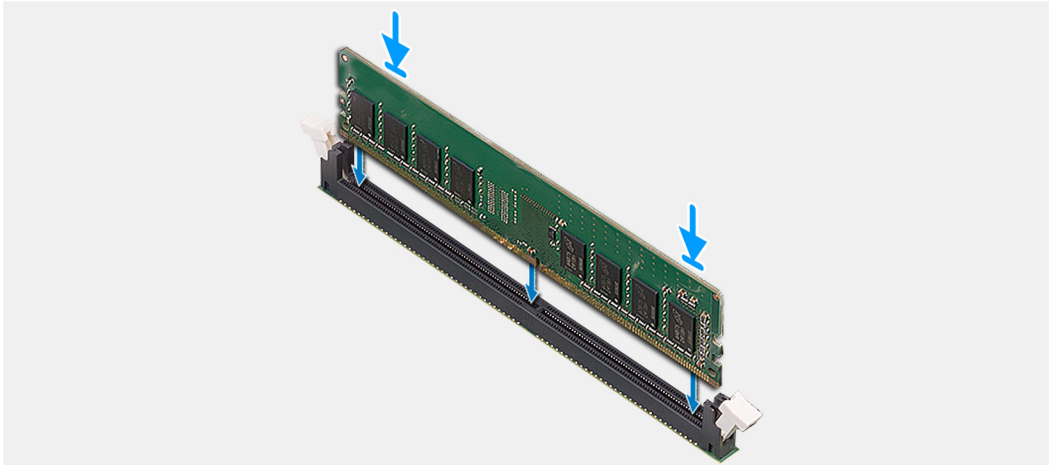
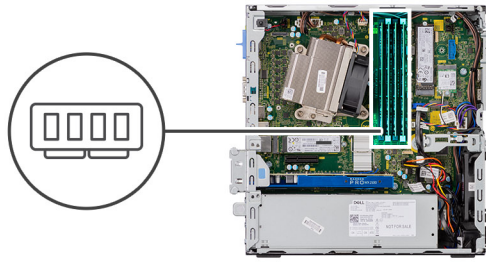

Steps

1. Align the notch on the memory module with the tab on the memory-module slot.
2. Slide the memory module firmly into the slot at an angle and press the memory module down until it clicks into place.

i **NOTE:** If you do not hear the click, remove the memory module and reinstall it.

Next steps

1. Install the [hard-disk drive and optical-disk drive module](#)
2. Install the [2.5 in. hard drive assembly](#).
3. Install the [front bezel](#).
4. Install the [side cover](#).
5. Follow the procedure in [after working inside your computer](#).

Heat sink

Removing the heat-sink

Prerequisites

1. Follow the procedure in [before working inside your computer](#).
2. Remove the [side cover](#).
3. Remove the [front bezel](#).
4. Remove the [hard-disk drive and optical-disk drive module](#).

About this task

The following images indicate the location of the heat-sink and provide a visual representation of the removal procedure.

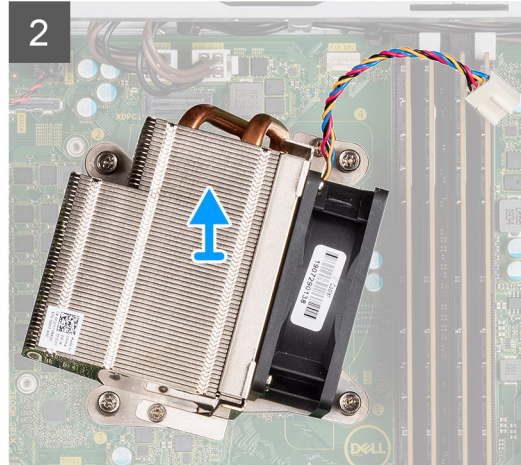
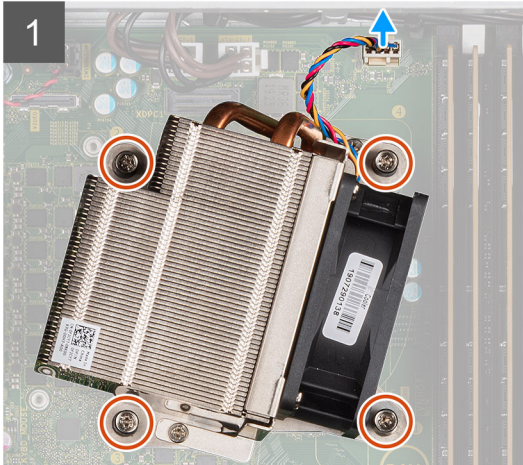

Steps

1. Disconnect the fan cable from the connector on the system board.
2. Loosen the four captive screws that secure the heat sink to the system board.
i **NOTE:** Loosen the screws in a sequential order (1,2,3,4) as mentioned on the system board.
3. Lift the heat-sink from the system board.

Installing the heat-sink

Prerequisites

About this task

The following image indicates the location of the VR heat sink and provides a visual representation of the installation procedure.

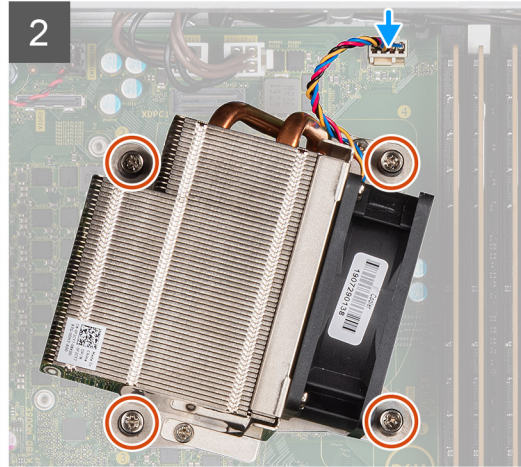
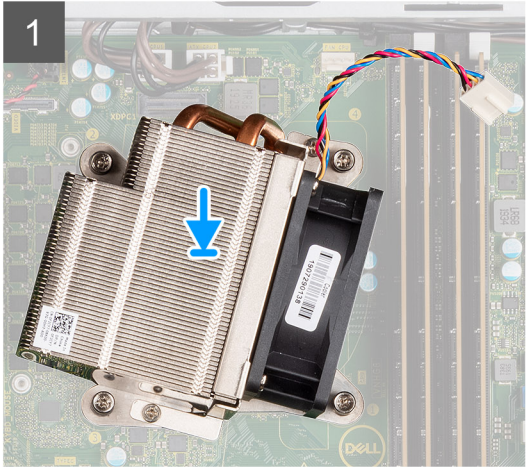

Steps

1. Place the heat sink on the processor.
2. Tighten the four captive screws that secure the heat-sink to the system board, as per the callout on the system board.
i **NOTE:** Tighten the screws in a sequential order (1,2,3,4) as mentioned on the system board.
3. Connect the heat sink fan cable to the system board.

Next steps

1. Install the [hard-disk drive and optical-disk drive module](#)
2. Install the [front bezel](#).
3. Install the [side cover](#).
4. Follow the procedure in [after working inside your computer](#).

Coin-cell battery

Removing the coin-cell battery

Prerequisites

1. Follow the procedure in [before working inside your computer](#).
2. Remove the [Side cover](#).
3. Remove the [Front bezel](#).
4. Remove the [Expansion card](#) (optional if installed)

About this task

The following images indicate the location of the coin-cell battery and provide a visual representation of the removal procedure.

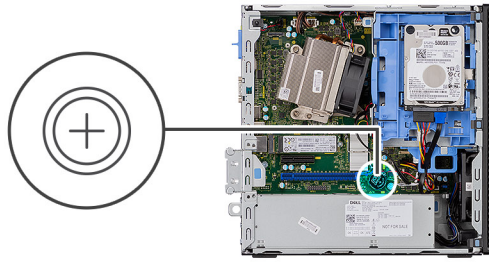

Steps

1. Using a plastic scribe, gently pry the coin-cell battery out of the battery socket.
2. Remove the coin-cell battery out of the system.

Installing the coin-cell battery

Prerequisites

About this task

The following image indicates the location of the coin-cell battery and provides a visual representation of the installation procedure.

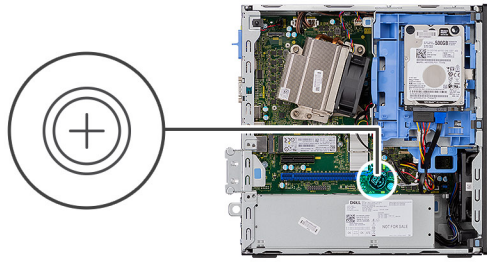

Steps

1. Insert the coin cell battery with the "+" sign facing up and slide it into the battery socket at an angle.
2. Press the battery into the connector until it clicks into place.

Next steps

1. Install the [Expansion card](#).
2. Install the [Front bezel](#).
3. Install the [Side cover](#).
4. Follow the procedure in [after working inside your computer](#).

Processor

Removing the processor

Prerequisites

1. Follow the procedure in [before working inside your computer](#).
2. Remove the [side cover](#).
3. Remove the [front bezel](#).
4. Remove the [2.5 in. hard drive assembly](#).
5. Remove the [hard-disk drive and optical-disk drive module](#).
6. Remove the [heat-sink](#).

About this task

 **NOTE:** The processor might still be hot after the computer is shut down. Allow the processor to cool down before removing it.

The following images indicate the location of the processor and provide a visual representation of the removal procedure.

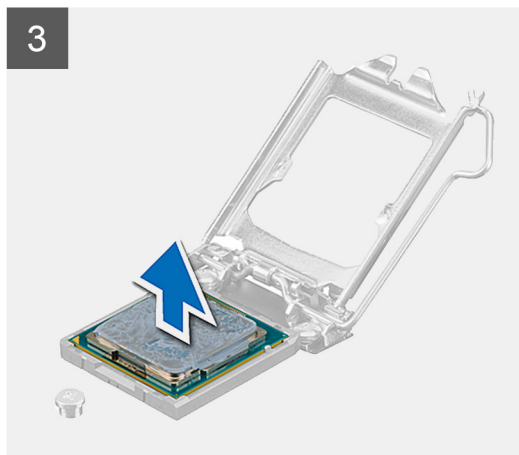
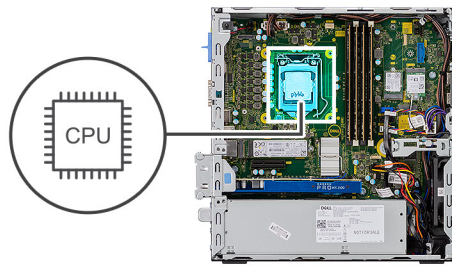

Steps

1. Press down and push the release lever away from the processor to release it from the securing tab.
2. Lift the lever upward to lift the processor cover.

 **CAUTION: When removing the processor, do not touch any of the pins inside the socket or allow any objects to fall on the pins in the socket.**

3. Gently lift the processor from the processor socket.

Installing the processor

Prerequisites

About this task

The following image indicates the location of the processor and provides a visual representation of the installation procedure.

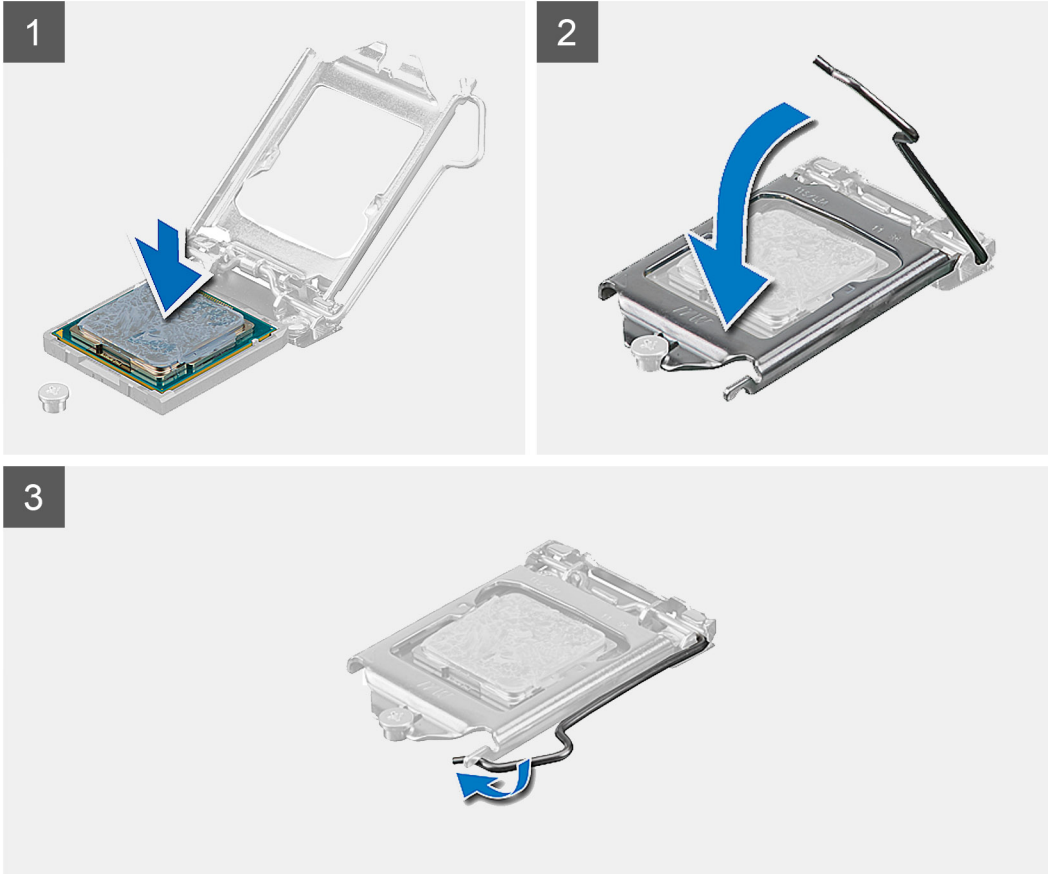
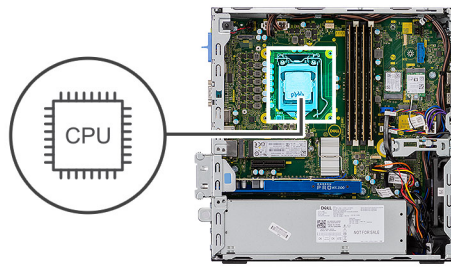

Steps

1. Align the pin-1 corner of the processor with the pin 1 corner of the processor socket, and then place the processor in the processor socket.
i **NOTE:** The pin-1 corner of the processor has a triangle that aligns with the triangle on the pin-1 corner on the processor socket. When the processor is properly seated, all four corners are aligned at the same height. If one or more corners of the processor are higher than the others, the processor is not seated properly.
2. When the processor is fully seated in the socket, close the processor cover.
3. Press down and push the release lever under the securing tab to lock it.

Next steps

1. Install the [heat-sink](#).
2. Install the [hard-disk drive and optical-disk drive module](#)
3. Install the [2.5 in. hard drive assembly](#).
4. Install the [front bezel](#).
5. Install the [side cover](#).
6. Follow the procedure in [after working inside your computer](#).

Power switch

Removing the power switch

Prerequisites

1. Follow the procedure in [before working inside your computer](#).
2. Remove the [side cover](#).
3. Remove the [front bezel](#).
4. Remove the [2.5 in. hard drive assembly](#).
5. Remove the [hard-disk drive and optical-disk drive module](#).

About this task

The following images indicate the location of the heat-sink and provide a visual representation of the removal procedure.

Steps

1. Disconnect the power switch cable from the system board.
2. Press the power switch retention tabs and pull the power switch out from the system.

Installing the power switch

Prerequisites

About this task

The following image indicates the location of the power switch and provides a visual representation of the installation procedure.

Steps

1. Slide the power switch module into the slot on the chassis until it clicks into place.
2. Connect the power switch cable to the connector on the system board.

Next steps

1. Install the [hard-disk drive and optical-disk drive module](#)
2. Install the [2.5 in. hard drive assembly](#).
3. Install the [front bezel](#).
4. Install the [side cover](#).
5. Follow the procedure in [after working inside your computer](#).

Power-supply unit

Removing the power-supply unit

Prerequisites

1. Follow the procedure in [Before working inside your computer](#).
2. Remove the [Side cover](#)
3. Remove the [Front bezel](#)
4. Remove the [2.5 in. hard drive assembly](#).
5. Remove the [hard-disk drive and optical-disk drive module](#).

About this task

The following images indicate the location of the power-supply unit and provide a visual representation of the removal procedure.



5x
6x32

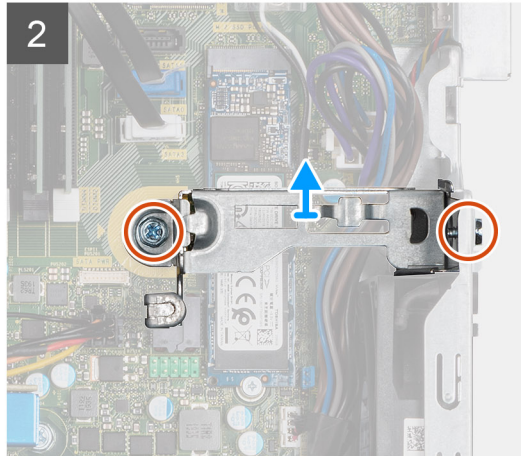
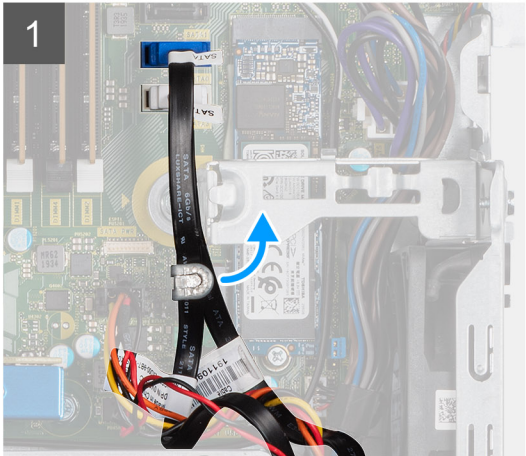
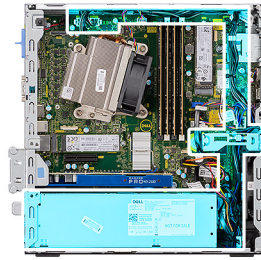



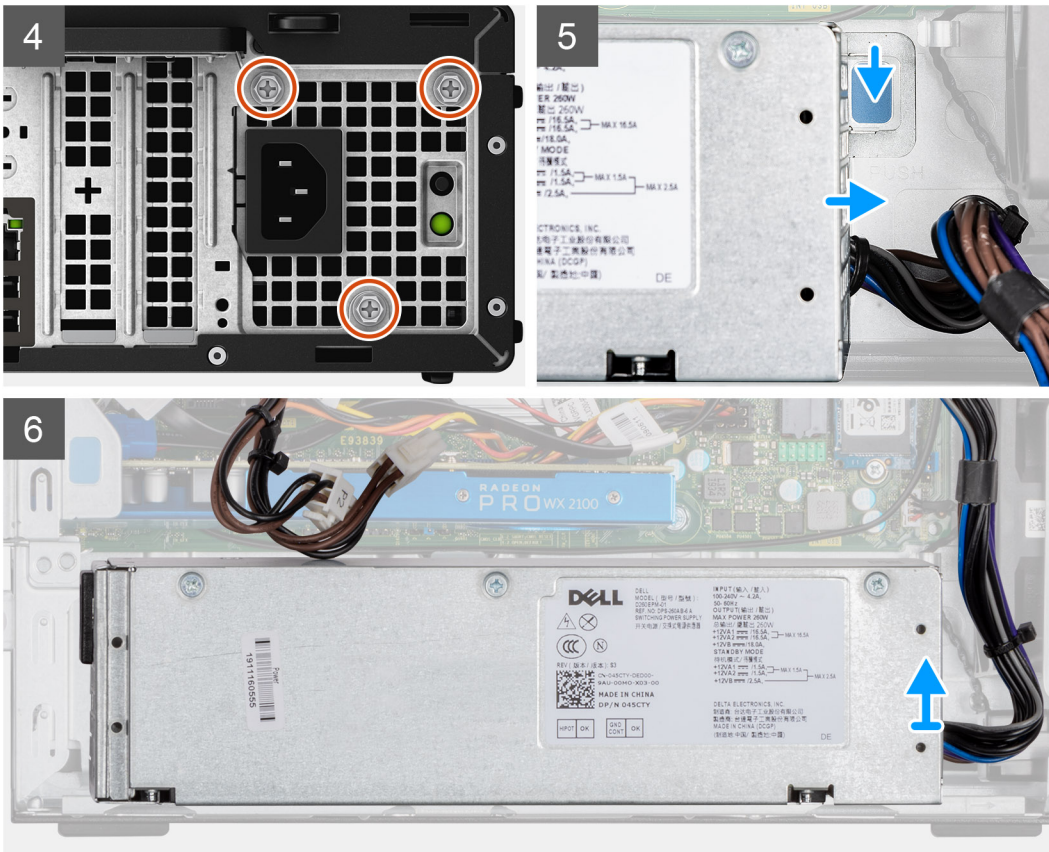

Steps

1. Remove the SATA cables from the retention clip on the support bracket.
2. Remove the two screws (M6x32) and slide the support bracket out from the slot.
3. Remove the power-supply cable from the retention clip on the chassis.
4. Remove the three screws (M6x32) that secure the power-supply unit to the back of the chassis.
5. Press the power-supply unit release latch and slide the unit into the chassis.
6. Remove the power-supply unit out of the chassis.

Installing the power-supply unit

Prerequisites

About this task

The following image indicates the location of the power-supply unit and provides a visual representation of the installation procedure.

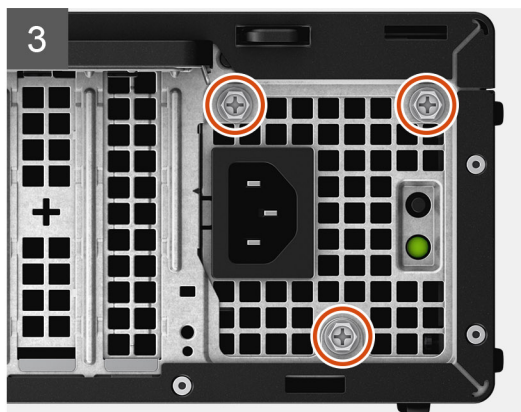
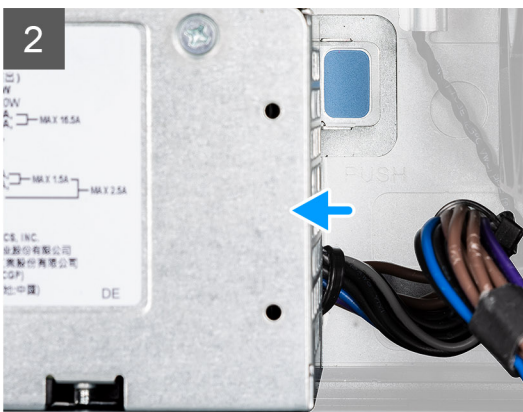
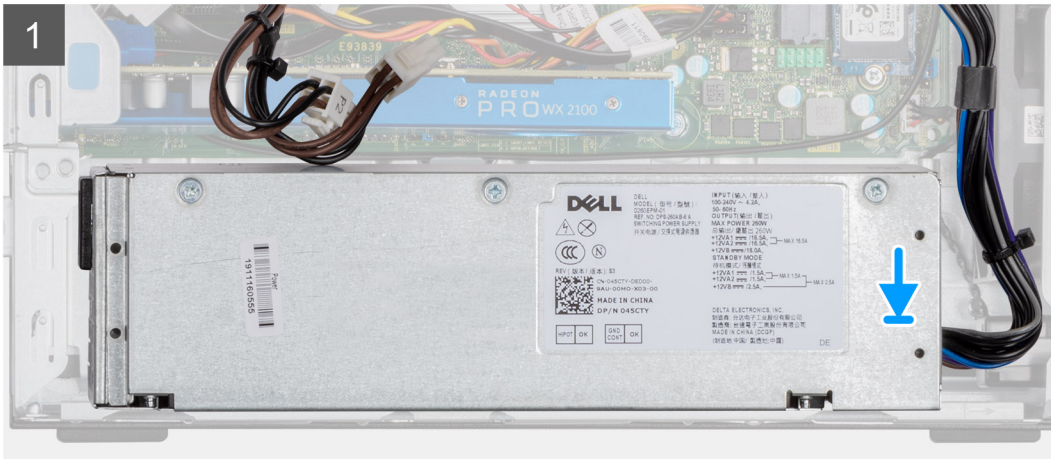

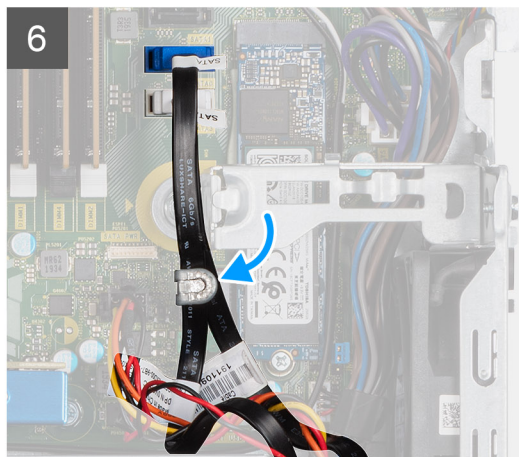
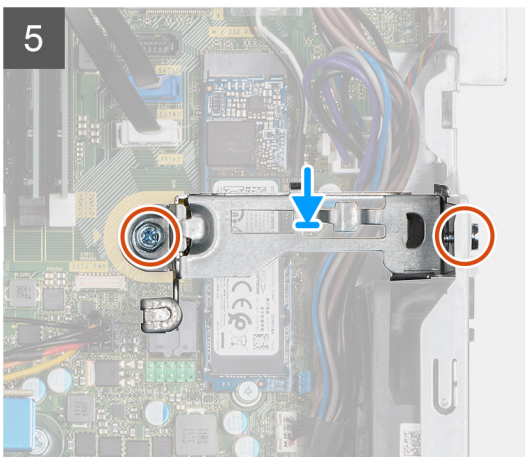

Steps

1. Align and place the power-supply unit into the slot on the chassis.
2. Slide the power-supply unit into the slot until it clicks in place.
3. Replace the three screws (M6x32) to secure the power-supply unit to the chassis.
4. Insert the power-supply cables through retention clips and connect it to the connectors on the system board.
5. Place the support bracket into the slot and secure it with the two screws (M6x32).
6. Insert the SATA cables through the retention clip on the support bracket.

Next steps

1. Install the [hard-disk drive and optical-disk drive module](#)
2. Install the [2.5 in. hard drive assembly](#).
3. Install the [Front bezel](#)
4. Install the [Side cover](#)
5. Follow the procedure in [After working inside your computer](#).

System fan

Removing the system fan

Prerequisites

1. Follow the procedure in [before working inside your computer](#).
2. Remove the [side cover](#).
3. Remove the [front bezel](#).
4. Remove the [2.5 in. hard drive assembly](#).
5. Remove the [hard-disk drive and optical-disk drive module](#) .

About this task

The following images indicate the location of the system fan and provide a visual representation of the removal procedure.

Steps

1. Disconnect the fan cable from the connector on the system board.
2. Slide the fan grommets towards the slot on the back of the fan chassis.
3. Lift the system fan from the system.

Installing the system fan

Prerequisites

About this task

The following image indicates the location of the VR heat sink and provides a visual representation of the installation procedure.

Steps

1. Align and place the system fan in the system chassis.
2. Pass the grommets through the chassis and slide outward along the groove to secure it in place.
3. Connect the system fan cable to the system board.

Next steps

1. Install the [hard-disk drive and optical-disk drive module](#)
2. Install the [2.5 in. hard drive assembly](#).
3. Install the [front bezel](#).
4. Install the [side cover](#).
5. Follow the procedure in [after working inside your computer](#).

System board

Removing the system board

Prerequisites

1. Follow the procedure in [before working inside your computer](#).
2. Remove the [side cover](#).
3. Remove the [front bezel](#).
4. Remove the [2.5 in. hard drive assembly](#).
5. Remove the [solid-state drive](#).
6. Remove the [WLAN card](#).
7. Remove the [heat-sink](#).
8. Remove the [memory modules](#).
9. Remove the [processor](#).

About this task

The following images indicate the location of the system board and provide a visual representation of the removal procedure.

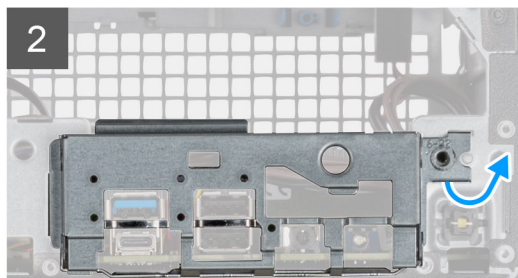
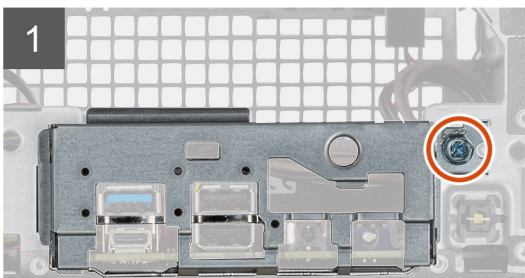
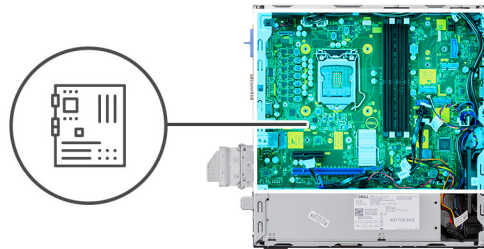

3

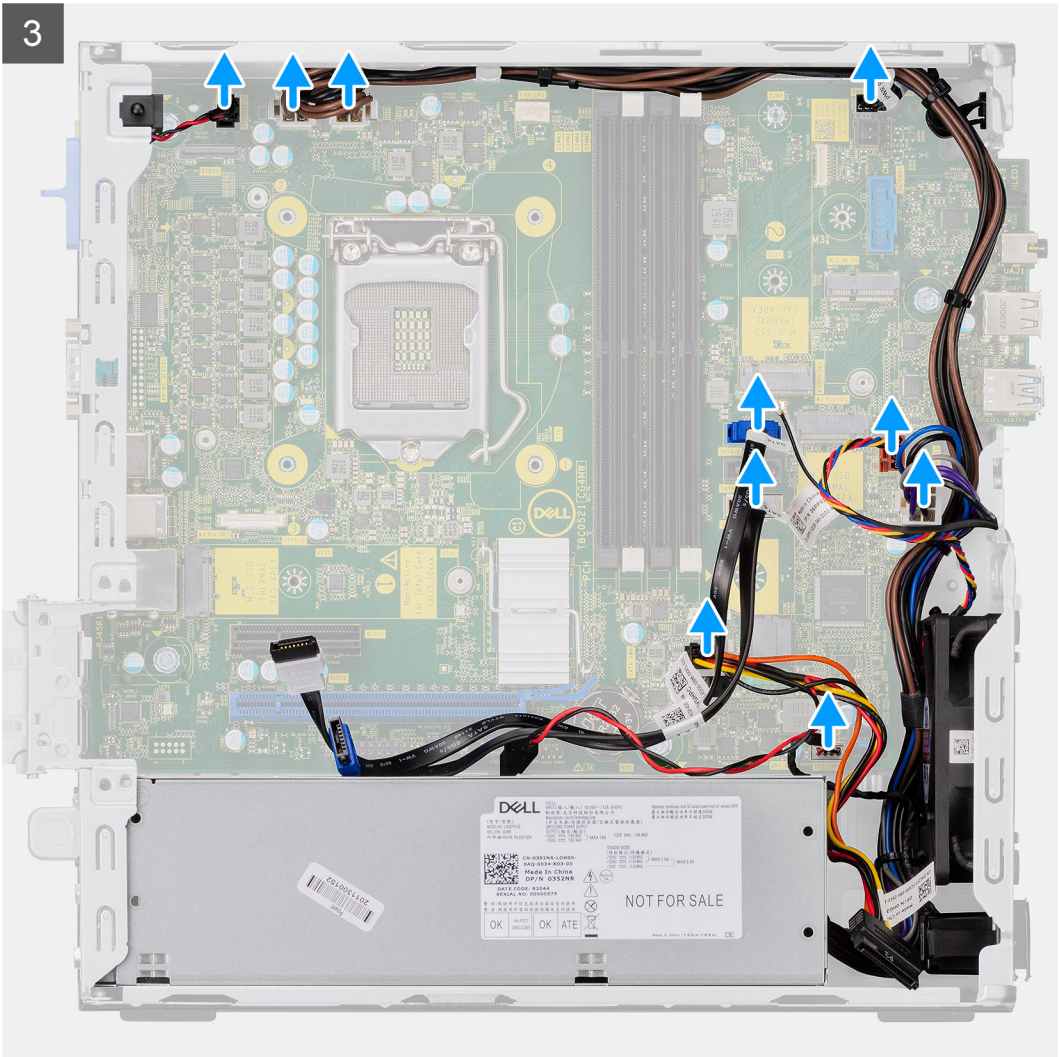

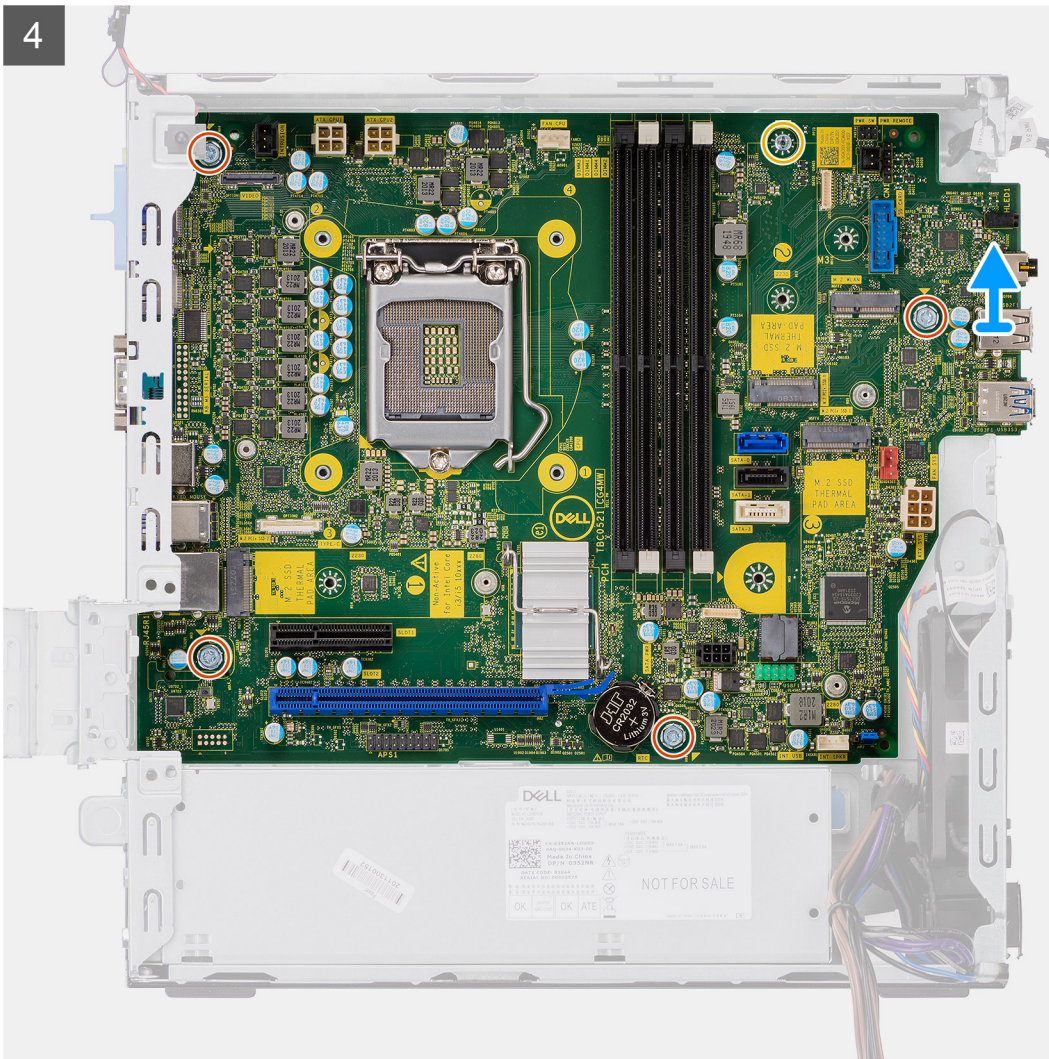

Steps

1. Remove the screw (6-32) that secures the I/O panel to the system chassis.
2. Lift the I/O panel away from the system chassis.
3. Disconnect the intrusion switch cable from the connector on the system board.
4. Disconnect the system board power supply cables.
5. Disconnect the power button switch cable from the connector on the system board.
6. Disconnect the system fan cable to the connector on the system board.
7. Disconnect the processor power supply cable from the connector on the system board.
8. Disconnect the SATA cables from the connector on the system board.
9. Disconnect the SATA power cable from the connector on the system board.
10. Disconnect the internal speaker cable from the connector on the system board.
11. Remove the four Screws (6-32) and the single standoff screw (M2X4) that secure the system board.
12. Lift the system board at an angle and slide it out of the system chassis.

Installing the system board

Prerequisites

About this task

The following image indicates the location of the system board and provides a visual representation of the installation procedure.



5x
6-32



1x
M2x4

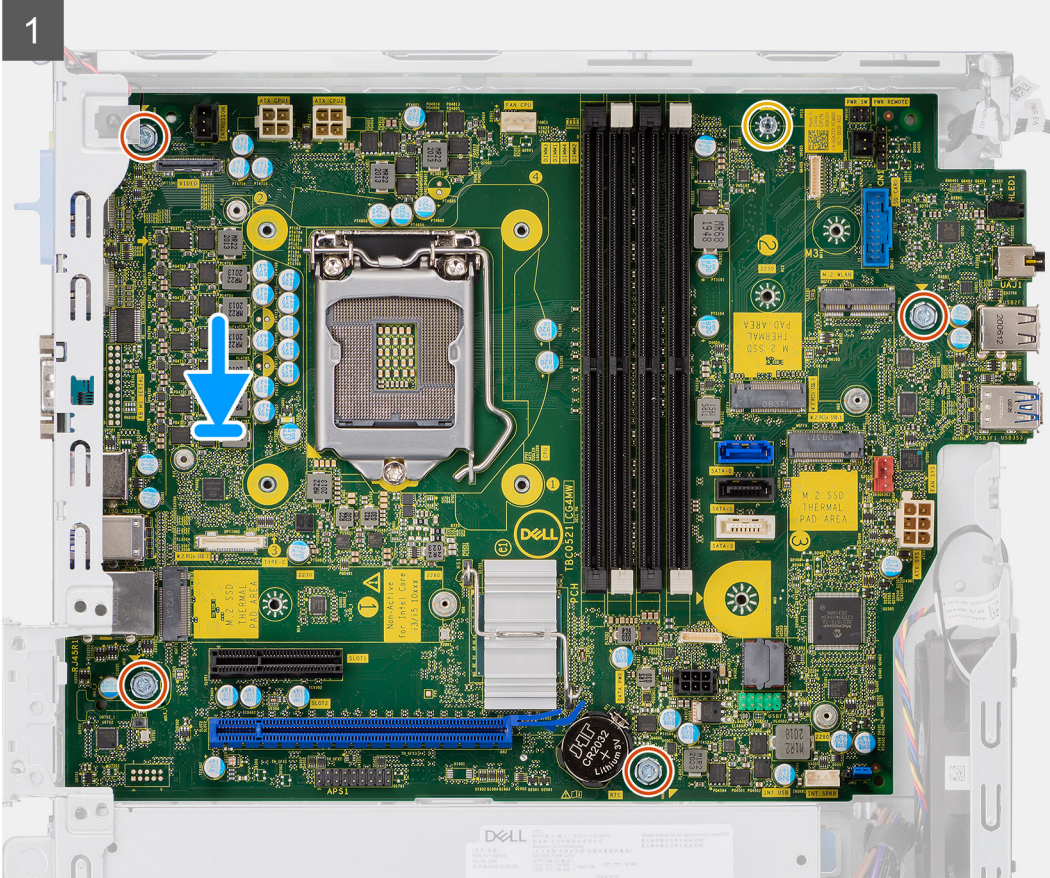
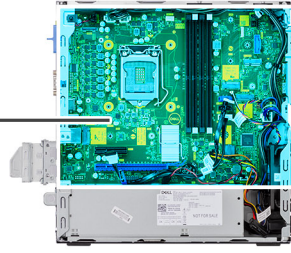

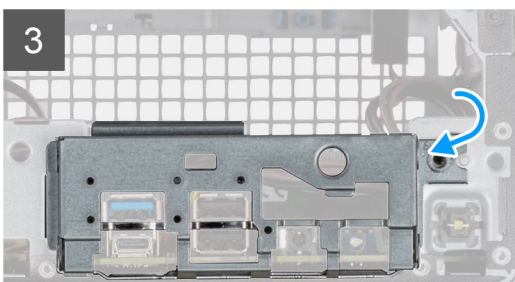
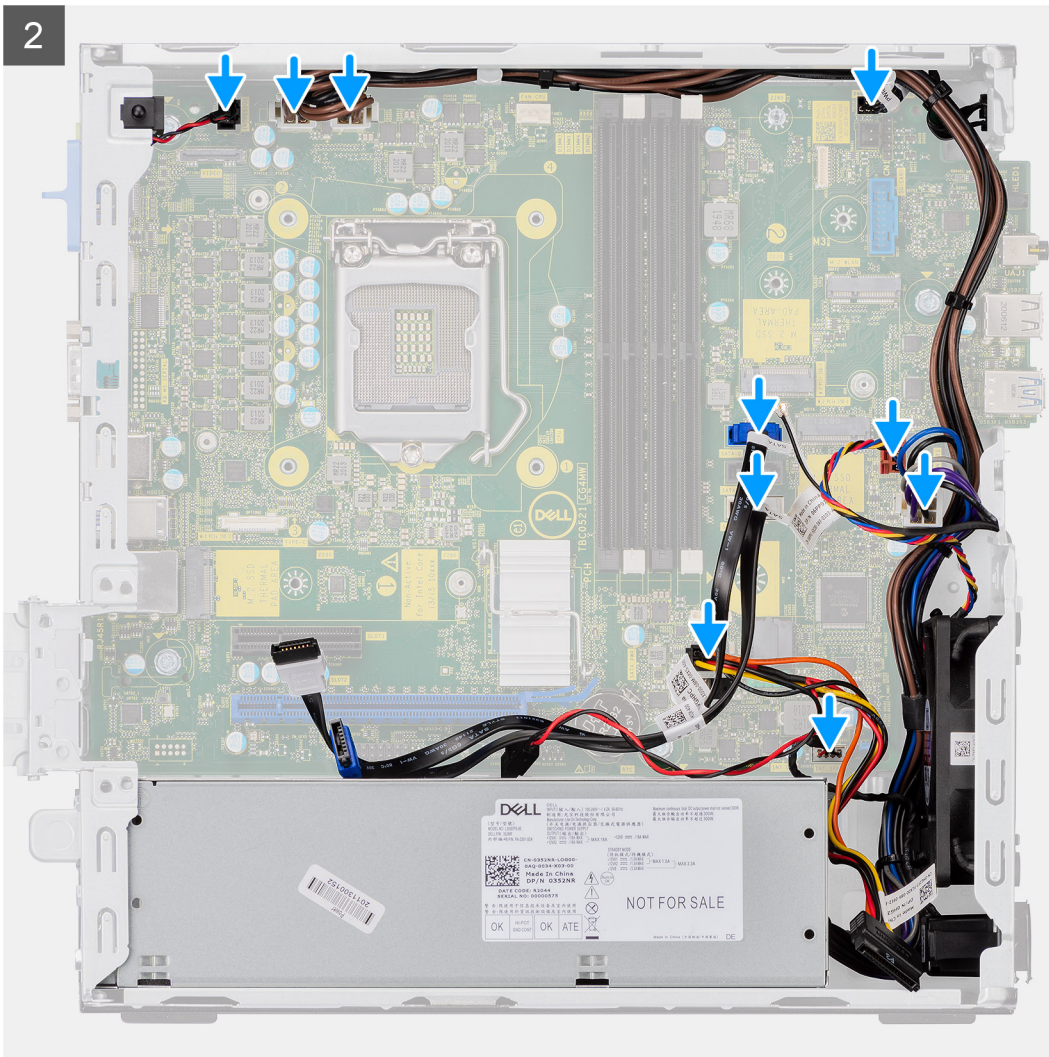

Steps

1. Align and lower the system board into the system until the connectors at the back of the system board align with the slots on the chassis, and the screw holes on the system board align with the standoffs on the system.
2. Replace the four screws (6-32) and the single standoff screw (M2x4) screw to secure the system board to the chassis.
3. Reconnect the intrusion switch cable to the connector on the system board.
4. Reconnect the system board power supply cables to the connector on the system board.
5. Reconnect the power button switch cable to the connector on the system board.
6. Reconnect the system fan cable to the connector on the system board.
7. Reconnect the processor power supply cable to the connector on the system board.
8. Reconnect the SATA cables to the connectors on the system board.
9. Reconnect the SATA power cable to the connector on the system board.
10. Reconnect the internal speaker cables to the connector on the system board.

11. Align and lower the I/O panel into the slot on the system chassis.
12. Replace the single screw (6-32) to secure the I/O panel to the system chassis.

Next steps

1. Install the [processor](#).
2. Install the [memory modules](#).
3. Install the [heat-sink](#).
4. Install the [WLAN card](#).
5. Install the [solid-state drive](#).
6. Install the [2.5 in. hard drive assembly](#).
7. Install the [front bezel](#).
8. Install the [side cover](#).
9. Follow the procedure in [after working inside your computer](#).

System board layout

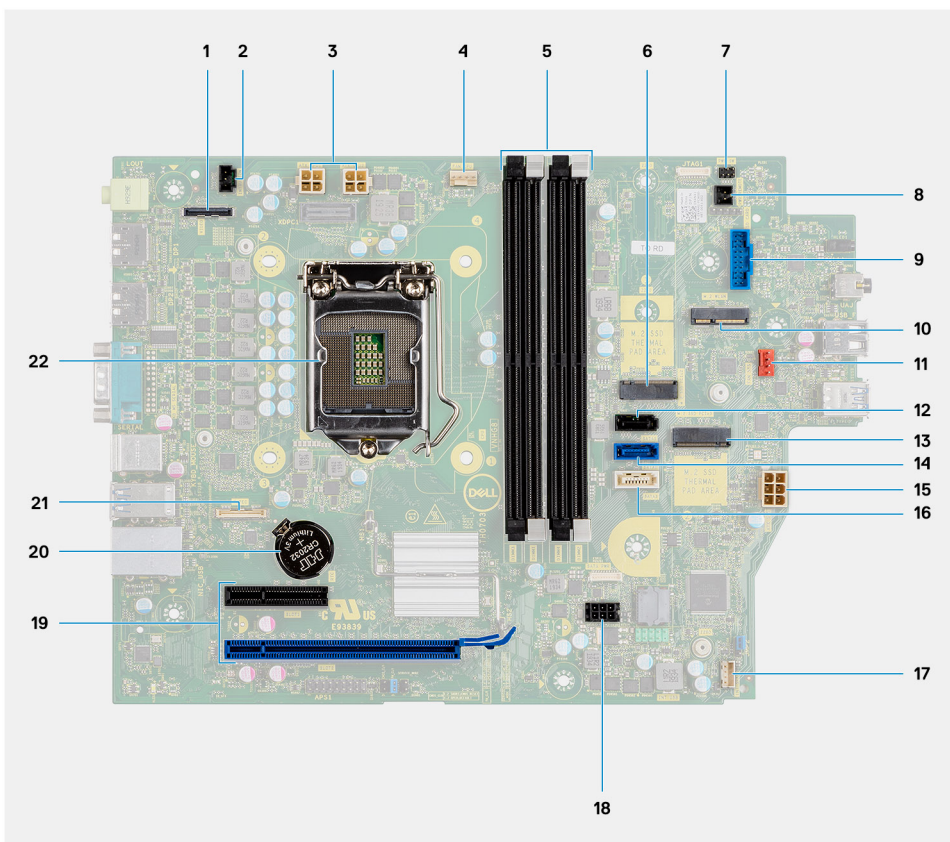

- | | |
|--|--|
| 1. Video connector | 2. Intrusion switch connector (Intruder) |
| 3. CPU power connector (ATX_CPU) | 4. CPU fan connector |
| 5. Memory slots (DIMM1, DIMM2, DIMM3, DIMM4) | 6. M.2 Solid-state drive connector |
| 7. Power switch connector (PWR_SW) | 8. Remote PWR switch connector |
| 9. Media card reader connector (Card_reader) | 10. M.2 WLAN connector |
| 11. System fan connector | 12. SATA 1 connector |
| 13. M.2 Solid-state drive connector | 14. SATA 2 connector |
| 15. PSU connector | 16. SATA 3 connector |
| 17. Internal speaker connector | 18. SATA power connector |
| 19. PCI-e connectors | 20. Coin cell battery |
| 21. USB Type-C connector | 22. Processor socket (CPU) |

Drivers and downloads

Topics:

- [Drivers and downloads](#)

Drivers and downloads

When troubleshooting, downloading or installing drivers it is recommended that you read the Dell Knowledge Based article, Drivers and Downloads FAQ [SLN128938](#).

System setup

Topics:

- [Boot Sequence](#)
- [System setup options](#)
- [Flashing the BIOS](#)
- [Updating the BIOS in Windows](#)
- [System and setup password](#)

Boot Sequence

Boot Sequence allows you to bypass the System Setup–defined boot device order and boot directly to a specific device (for example: optical drive or hard drive). During the Power-on Self Test (POST), when the Dell logo appears, you can:

- Access System Setup by pressing F2 key
- Bring up the one-time boot menu by pressing F12 key

The one-time boot menu displays the devices that you can boot from including the diagnostic option. The boot menu options are:

- Removable Drive (if available)
- STXXXX Drive (if available)
 - **i** **NOTE:** XXX denotes the SATA drive number.
- Optical Drive (if available)
- SATA Hard Drive (if available)
- Diagnostics

The boot sequence screen also displays the option to access the System Setup screen.

System setup options

i **NOTE:** Depending on your computer and its installed devices, the items that are listed in this section may or may not appear.

Table 3. System setup options—System information menu

Overview	
Precision 3450 SFF	
BIOS Version	Displays the BIOS version number.
Service Tag	Displays the Service Tag of the computer.
Asset Tag	Displays the Asset Tag of the computer.
Manufacture Date	Displays the manufacture date of the computer.
Ownership Date	Displays the ownership date of the computer.
Express Service Code	Displays the express service code of the computer.
Ownership Tag	Displays the Ownership Tag of the computer.
Signed Firmware Update	Displays whether the Signed Firmware Update is enabled on your computer.
Processor Information	

Table 3. System setup options—System information menu (continued)

Overview	
Processor Type	Displays the processor type.
Maximum Clock Speed	Displays the maximum processor clock speed.
Minimum Clock Speed	Displays the minimum processor clock speed.
Current Clock Speed	Displays the current processor clock speed.
Core Count	Displays the number of cores on the processor.
Processor ID	Displays the processor identification code.
Processor L2 Cache	Displays the processor L2 Cache size.
Processor L3 Cache	Displays the processor L3 Cache size.
Microcode Version	Displays the microcode version.
Intel Hyper-Threading Capable	Displays whether the processor is Hyper-Threading (HT) capable.
64-Bit Technology	Displays whether 64-bit technology is used.
Memory Information	
Memory Installed	Displays the total computer memory installed.
Memory Available	Displays the total computer memory available.
Memory Speed	Displays the memory speed.
Memory Channel Mode	Displays single or dual channel mode.
Memory Technology	Displays the technology that is used for the memory.
DIMM 1 Size	Displays the DIMM 1 memory size.
DIMM 2 Size	Displays the DIMM 2 memory size.
DIMM 3 Size	Displays the DIMM 3 memory size.
DIMM 4 Size	Displays the DIMM 4 memory size.
Devices Information	
Video Controller	Displays the video controller type of the computer.
Video Memory	Displays the video memory information of the computer.
Wi-Fi Device	Displays the wireless device information of the computer.
Native Resolution	Displays the native resolution of the computer.
Video BIOS Version	Displays the video BIOS version of the computer.
Audio Controller	Displays the audio controller information of the computer.
Bluetooth Device	Displays the Bluetooth device information of the computer.
LOM MAC Address	Displays the LAN On Motherboard (LOM) MAC address of the computer.
dGPU Video Controller	Displays the discrete video controller type of the computer.
Slot 1	Displays the SATA hard drive information of the computer.
Slot 2	Displays the SATA hard drive information of the computer.
Slot 3	Displays the SATA hard drive information of the computer.
Slot 4	Displays the SATA hard drive information of the computer.

Table 4. System setup options—Boot Configuration menu

Boot Configuration	
Boot Sequence	
Boot Mode: UEFI only	Displays the boot mode.

Table 4. System setup options—Boot Configuration menu (continued)

Boot Configuration	
Boot Sequence	Displays the boot sequence.
Secure Digital (SD) Card Boot	Enable or disable the SD card read-only boot. By default, the Secure Digital (SD) Card Boot option is not enabled.
Secure Boot	
Enable Secure Boot	Enable or disable the secure boot feature. By default, the option is not enabled.
Secure Boot Mode	Enable or disable to change the secure boot mode options. By default, the Deployed Mode is enabled.
Expert Key Management	
Enable Custom Mode	Enable or disable custom mode. By default, the custom mode option is not enabled.
Custom Mode Key Management	Select the custom values for expert key management.

Table 5. System setup options—Integrated Devices menu

Integrated Devices	
Date/Time	Displays the current date in MM/DD/YYYY format and current time in HH:MM:SS AM/PM format.
Audio	
Enable Audio	Enable or disable the integrated audio controller. By default, all the options are enabled.
Serial Port	
Serial Port Configuration	Enable or disable the serial port address. By default, the COM1: Port is configured at 3F8h with IRQ4 option is enabled.
USB Configuration	<ul style="list-style-type: none"> Enable or disable booting from USB mass storage devices through the boot sequence or boot menu. By default, all the options are enabled.
Front USB Configuration	Enable or disable the individual front USB ports. By default, all the options are enabled.
Rear USB Configuration	Enable or disable the individual rear USB ports. By default, all the options are enabled.
Miscellaneous Devices	Enable or disable the PCI Slot By default, the option is enabled.
Dust Filter Maintenance	Enable or disable the dust filter maintenance. By default, the Disabled option is enabled.

Table 6. System setup options—Storage menu

Storage	
SATA Operation	Enable or disable the operating mode of the integrated SATA hard drive controller.

Table 6. System setup options—Storage menu (continued)

Storage	
	By default, the AHCI option is enabled.
Storage Interface	
Port Enablement	Enable or disable the onboard drives. By default, all the options are enabled.
SMART Reporting	
Enable SMART Reporting	Enable or disable Self-Monitoring, Analysis, and Reporting Technology (SMART) during computer startup. By default, the Enable SMART Reporting option is not enabled.
Drive Information	
SATA-0	
Type	Displays the SATA HDD type information of the computer.
Device	Displays the SATA HDD device information of the computer.
SATA-1	
Type	Displays the SATA HDD type information of the computer.
Device	Displays the SATA HDD device information of the computer.
SATA-2	
Type	Displays the SATA HDD type information of the computer.
Device	Displays the SATA HDD device information of the computer.
SATA-3	
Type	Displays the SATA HDD type information of the computer.
Device	Displays the SATA HDD device information of the computer.
M.2 PCIe SSD-0	
Type	Displays the M.2 PCIe SSD-0 type information of the computer.
Device	Displays the M.2 PCIe SSD-0 device information of the computer.
M.2 PCIe SSD-1	
Type	Displays the M.2 PCIe SSD-1 type information of the computer.
Device	Displays the M.2 PCIe SSD-1 device information of the computer.
Enable MediaCard	
Secure Digital (SD) Card	Enable or disable the SD card. By default, the Secure Digital (SD) Card option is enabled.
Secure Digital (SD) Card Read-Only Mode	Enable or disable the SD card read-only mode. By default, the Secure Digital (SD) Card Read-Only Mode option is not enabled.

Table 7. System setup options—Display menu

Display	
Multi-Display	
Enable Multi-Display	Enable or disable the Enable Multi-Display buttons on the computer. By default, the option is enabled.
Primary Display	

Table 7. System setup options—Display menu (continued)

Display	
Video Primary Display	Determines the primary display when multiple controllers are available on the computer By default, the Auto option is enabled.
Full Screen Logo	Enable or disable full screen logo. By default, the option is not enabled.

Table 8. System setup options—Connection menu

Connection	
Network Controller Configuration	
Integrated NIC	Controls the on-board LAN controller. By default, the Enabled with PXE option is enabled.
Wireless Device Enable	
WLAN	Enable or disable the internal WLAN device By default, the option enabled.
Bluetooth	Enable or disable the internal Bluetooth device By default, the option enabled.
Enable UEFI Network Stack	Enable or disable UEFI Network Stack and controls the on-board LAN Controller. By default, the option is enabled.
HTTPs Boot Feature	
HTTPs Boot	Enable or disable the HTTPs Boot feature. By default, the HTTPs Boot option is enabled.
HTTPs Boot Mode	With Auto Mode, the HTTPs Boot extracts Boot URL from the DHCP. With Manual Mode, the HTTPs Boot reads Boot URL from the user-provided data. By default, the Auto Mode option is enabled.

Table 9. System setup options—Power menu

Power	
USB PowerShare	
Enable USB PowerShare	Enable or disable the USB PowerShare. By default, the Enable USB PowerShare option is enabled
USB Wake Support	
Enable USB Wake Support	When enabled, you can use the USB devices like a mouse or keyboard to wake your computer from standby. By default, the option is enabled.
AC Behavior	
AC Recovery	Enables the system to turn on automatically, when AC is inserted. By default, the Power Off option is enabled.
Active State Power Management	
Aspm	Enables or disables the Active State Power Management (ASPM) level By default, the Auto option is enabled.

Table 9. System setup options—Power menu (continued)

Power	
Block Sleep	Enables to block entering sleep (S3) mode in the operating system. By default, the Block Sleep option is disabled.
Deep Sleep Control	Enable or disable the Deep Sleep mode support. By default, the Disabled option is enabled.
Fan Control Override	Enable or disable the fan control override feature. By default, the option is disabled.
Intel Speed Shift Technology	Enable or disable the Intel speed shift technology support. By default, the Intel Speed Shift Technology option is enabled.

Table 10. System setup options—Security menu

Security	
TPM 2.0 Security	
TPM 2.0 Security On	Enable or disable TPM 2.0 security options. By default, the TPM 2.0 Security On option is enabled.
Attestation Enable	Enables to control whether the Trusted Platform Module (TPM) Endorsement Hierarchy is available to the operating system. By default, the Attestation Enable option is enabled.
Key Storage Enable	Enables to control whether the Trusted Platform Module (TPM) Storage Hierarchy is available to the operating system. By default, the Key Storage Enable option is enabled.
SHA-256	BIOS and the TPM will use the SHA-256 hash algorithm to extend measurements into the TPM PCRs during BIOS boot. By default, the SHA-256 option is enabled.
Clear	Enables to clear the TPM owner information and returns the TPM to the default state. By default, the Clear option is disabled.
PPI ByPass for Clear Commands	Controls the TPM Physical Presence Interface (PPI). By default, the PPI ByPass for clear Commands option is disabled.
Chassis intrusion	Controls the chassis intrusion feature. By default, the option is disabled.
SMM Security Mitigation	Enable or disable SMM Security Mitigation. By default, the option is enabled.
Data Wipe on Next Boot	
Start Data Wipe	Enable or disable the data wipe on next boot. By default, the option is disabled.
Absolute	Enable or disable or permanently disable the BIOS module interface of the optional Absolute Persistence Module service from Absolute software. By default, the Enable Absolute option is enabled.
UEFI Boot Path Security	Controls whether or not the computer will prompt the user to enter the admin password (if set) when booting to a UEFI boot device from the F12 boot menu.

Table 10. System setup options—Security menu (continued)

Security	
	By default, the Always Except Internal HDD option is enabled.

Table 11. System setup options—Passwords menu

Passwords	
Admin Password	Set, change, or delete the administrator password.
System Password	Set, change, or delete the computer password.
Internal HDD-0 Password	Set, change, or delete the Internal HDD-0 password.
NVMe SSD0	Set, change, or delete the NVMe SSD0 password.
Password Configuration	
Upper Case Letter	Reinforces password must have at least one upper case letter. By default, the option is disabled.
Lower Case Letter	Reinforces password must have at least one lower case letter. By default, the option is disabled.
Digit	Reinforces password must have at least one digit. By default, the option is disabled.
Special Character	Reinforces password must have at least one special character. By default, the option is disabled.
Minimum Characters	Set the minimum characters allowed for password.
Password Bypass	When enabled, this always prompts for computer and internal hard drive passwords when powered on from the off state. By default, the Disabled option is enabled.
Password Changes	
Enable Non-Admin Password Changes	Enable or disable to change computer and hard drive password without the need for admin password. By default, the option is enabled.
Admin Setup Lockout	
Enable Admin Setup Lockout	Enables administrators control over how their users can or cannot access BIOS setup. By default, the option is disabled.
Master Password Lockout	
Enable Master Password Lockout	When enabled, this will disable the master password support. By default, the option is disabled.
Allow Non-Admin PSID Revert	
Enable Allow Non-Admin PSID Revert	Controls access to the Physical Security ID (PSID) revert of NVMe hard-drives from the Dell Security Manager prompt. By default, the option is disabled.

Table 12. System setup options—Update, Recovery menu

Update, Recovery	
UEFI Capsule Firmware Updates	Enable or disable BIOS updates through UEFI capsule update packages.

Table 12. System setup options—Update, Recovery menu (continued)

Update, Recovery	
BIOS Recovery from Hard Drive	<p>By default, the option is enabled.</p> <p>Enables the user to recover from certain corrupted BIOS conditions from a recovery file on the user primary hard drive or an external USB key.</p> <p>By default, the option is enabled.</p>
BIOS Downgrade	
Allow BIOS Downgrade	<p>Enable or disable the flashing of the computer firmware to previous revision is blocked.</p> <p>By default, the option is enabled.</p>
SupportAssist OS Recovery	<p>Enable or disable the boot flow for SupportAssist OS Recovery tool in the event of certain computer errors.</p> <p>By default, the option is enabled.</p>
BIOSConnect	<p>Enable or disable cloud Service OS recovery if the main operating system fails to boot with the number of failures equal to or greater than the value specified by the Auto OS Recovery Threshold setup option and local Service OS does not boot or is not installed.</p> <p>By default, the option is enabled.</p>
Dell Auto OS Recovery Threshold	<p>Controls the automatic boot flow for SupportAssist System Resolution Console and for Dell OS Recovery Tool.</p> <p>By default, the threshold value is set to 2.</p>

Table 13. System setup options—System Management menu

System Management	
Service Tag	Display the Service Tag of the computer.
Asset Tag	Create a computer Asset Tag.
Wake on LAN/WLAN	<p>Enable or disable the computer to power on by special LAN signals when it receives a wakeup signal from the WLAN.</p> <p>By default, the Disabled option is selected.</p>
Auto on Time	<p>Enable to set the computer to turn on automatically every day or on a preselected date and time. This option can be configured only if the Auto On Time is set to Everyday, Weekdays, or Selected Days.</p> <p>By default, the option is disabled.</p>
Intel AMT Capability	
Enable Intel AMT Capability	<p>Enable or disable the Intel AMT capability.</p> <p>By default, the Restrict MEBx Access option is enabled.</p>
MEBx Hotkey	<p>Enable or disable MEBx hotkey.</p> <p>By default, the option is disabled.</p>
USB Provision	
Enable USB Provision	<p>Enable or disable the Intel AMT provisioning using the local provisioning file through a USB storage device.</p> <p>By default, the option is disabled.</p>
SERR Messages	<p>Enable or disable SERR messages.</p> <p>By default, the option is enabled.</p>

Table 13. System setup options—System Management menu (continued)

System Management	
Dell Development Configuration	
Enable Flash Updated Signature Override	Enable or disable certain features to control BIOS By default, the option is disabled.

Table 14. System setup options—Keyboard menu

Keyboard	
Keyboard Errors	
Enable Keyboard Error Detection	Enable or disable the keyboard error detection. By default, the option is enabled.
Numlock LED	
Enable Numlock LED	Enable or disable Numlock LED. By default, the option is enabled.
Device Configuration Hotkey Access	
Device Configuration Hotkey Access	Enable or disable users to access device configuration by using hotkeys. By default, the option is enabled.

Table 15. System setup options—Pre-boot Behavior menu

Pre-boot Behavior	
Warning and Errors	
	Enable or disable the action to be done when a warning or error is encountered. By default, the Prompt on Warnings and Errors option is enabled.
Fastboot	
	Enable to set the speed of the boot process. By default, the Minimal option is enabled.
Extend BIOS POST Time	
	Set the BIOS POST time. By default, the 0 seconds option is enabled.

Table 16. System setup options—Virtualization menu

Virtualization	
Intel Virtualization Technology	
Enable Intel Virtualization Technology (VT)	Specify whether a Virtual Machine Monitor (VMM) can utilize the additional hardware capabilities that are provided by Intel Virtualization Technology. By default, the option is enabled.
VT for Direct I/O	
	Specify whether a Virtual Machine Monitor (VMM) can utilize the additional hardware capabilities that are provided by Intel Virtualization Technology for Direct I/O. By default, the option is enabled.
Intel Trusted Execution Technology (TXT)	
Enable Intel Trusted Execution Technology (TXT)	Specifies whether a measured Virtual Machine Monitor (MVMM) can utilize the additional hardware capabilities that are provided by Intel Trusted Execution Technology. By default, the option is disabled.

Table 17. System setup options—Performance menu

Performance	
Multi Core Support	
Active Cores	Enables to change the number of CPU cores available to the operating system. By default, the All Cores options are enabled.
Intel SpeedStep	
Enable Intel SpeedStep Technology	Enables the computer to dynamically adjust processor voltage and core frequency, decreasing average power consumption and heat production. By default, the option is enabled.
C-States Control	
Enable C-State Control	Enable or disable additional processor sleep states. By default, the option is enabled.
Intel Turbo Boost Technology	
Enable Intel Turbo Boost Technology	Enable or disable Intel TurboBoost mode of the processor. By default, the option is enabled.
Intel Hyper-Threading Technology	
Enable Intel Hyper-Threading Technology	Enable or disable Hyper-Threading in the processor. By default, the option is enabled.

Table 18. System setup options—System Logs menu

System Logs	
BIOS Event Log	
Clear BIOS Event Log	Display BIOS events. By default, the Keep option is enabled.

Flashing the BIOS

About this task

You may need to flash (update) the BIOS when an update is available or when you replace the system board. Follow these steps to flash the BIOS:

Steps

1. Turn on your computer.
2. Go to www.dell.com/support.
3. Click **Product support**, enter the Service Tag of your computer, and then click **Submit**.
 **NOTE:** If you do not have the Service Tag, use the auto-detect feature or manually browse for your computer model.
4. Click **Drivers & downloads > Find it myself**.
5. Select the operating system installed on your computer.
6. Scroll down the page and expand **BIOS**.
7. Click **Download** to download the latest version of the BIOS for your computer.
8. After the download is complete, navigate to the folder where you saved the BIOS update file.
9. Double-click the BIOS update file icon and follow the instructions on the screen.

Updating the BIOS in Windows

Prerequisites

It is recommended to update your BIOS (System Setup) when you replace the system board or if an update is available. For laptops, ensure that your computer battery is fully charged and connected to a power before initiating a BIOS update.

About this task

 **NOTE:** If BitLocker is enabled, it must be suspended prior to updating the system BIOS, and then re enabled after the BIOS update is completed.

Steps

1. Restart the computer.
2. Go to **Dell.com/support**.
 - Enter the **Service Tag** or **Express Service Code** and click **Submit**.
 - Click **Detect Product** and follow the instructions on screen.
3. If you are unable to detect or find the Service Tag, click **Choose from all products**.
4. Choose the **Products** category from the list.

 **NOTE:** Choose the appropriate category to reach the product page.
5. Select your computer model and the **Product Support** page of your computer appears.
6. Click **Get drivers** and click **Drivers and Downloads**.
The Drivers and Downloads section opens.
7. Click **Find it myself**.
8. Click **BIOS** to view the BIOS versions.
9. Identify the latest BIOS file and click **Download**.
10. Select your preferred download method in the **Please select your download method below** window, click **Download File**.
The **File Download** window appears.
11. Click **Save** to save the file on your computer.
12. Click **Run** to install the updated BIOS settings on your computer.
Follow the instructions on the screen.

Updating BIOS on systems with BitLocker enabled

 **CAUTION:** If BitLocker is not suspended before updating the BIOS, the next time you reboot the system it will not recognize the BitLocker key. You will then be prompted to enter the recovery key to progress and the system will ask for this on each reboot. If the recovery key is not known this can result in data loss or an unnecessary operating system re-install. For more information on this subject, see Knowledge Article: <https://www.dell.com/support/article/sln153694>

Updating your system BIOS using a USB flash drive

About this task

If the computer cannot load into Windows but there is still a need to update the BIOS, download the BIOS file using another computer and save it to a bootable USB flash drive.

 **NOTE:** You must use a bootable USB flash drive. For more information, see the knowledge base article [SLN143196](#).

Steps

1. Download the BIOS update .exe file to another computer.
2. Copy the .exe file onto the bootable USB flash drive.

3. Insert the USB flash drive into the computer that requires the BIOS update.
4. Restart the computer and press F12 when the Dell logo appears to display the One Time Boot Menu.
5. Using arrow keys, select **USB Storage Device** and press Enter.
6. The computer restarts to a Diag C:\> prompt.
7. Run the file by typing the complete filename and press Enter.
8. The BIOS Update Utility is displayed. Follow the on-screen instructions.



Figure 1. DOS BIOS Update Screen

System and setup password

Table 19. System and setup password

Password type	Description
System password	Password that you must enter to log on to your system.
Setup password	Password that you must enter to access and make changes to the BIOS settings of your computer.

You can create a system password and a setup password to secure your computer.

CAUTION: The password features provide a basic level of security for the data on your computer.

CAUTION: Anyone can access the data stored on your computer if it is not locked and left unattended.

NOTE: System and setup password feature is disabled.

Assigning a system setup password

Prerequisites

You can assign a new **System or Admin Password** only when the status is in **Not Set**.

About this task

To enter the system setup, press F2 immediately after a power-on or reboot.

Steps

1. In the **System BIOS** or **System Setup** screen, select **Security** and press **Enter**.
The **Security** screen is displayed.
2. Select **System/Admin Password** and create a password in the **Enter the new password** field.
Use the following guidelines to assign the system password:
 - A password can have up to 32 characters.
 - The password can contain the numbers 0 through 9.
 - Only lower case letters are valid, upper case letters are not allowed.
 - Only the following special characters are allowed: space, ("), (+), (,), (-), (.), (/), (;), ([), (\), (]), (`).
3. Type the system password that you entered earlier in the **Confirm new password** field and click **OK**.
4. Press **Esc** and a message prompts you to save the changes.
5. Press **Y** to save the changes.
The computer reboots.

Deleting or changing an existing system setup password

Prerequisites

Ensure that the **Password Status** is Unlocked (in the System Setup) before attempting to delete or change the existing System and Setup password. You cannot delete or change an existing System or Setup password, if the **Password Status** is Locked.

About this task

To enter the System Setup, press **F2** immediately after a power-on or reboot.

Steps

1. In the **System BIOS** or **System Setup** screen, select **System Security** and press **Enter**.
The **System Security** screen is displayed.
2. In the **System Security** screen, verify that **Password Status** is **Unlocked**.
3. Select **System Password**, alter or delete the existing system password and press **Enter** or **Tab**.
4. Select **Setup Password**, alter or delete the existing setup password and press **Enter** or **Tab**.
 **NOTE:** If you change the System and/or Setup password, re enter the new password when prompted. If you delete the System and Setup password, confirm the deletion when prompted.
5. Press **Esc** and a message prompts you to save the changes.
6. Press **Y** to save the changes and exit from System Setup.
The computer restarts.

Troubleshooting

Topics:

- Dell SupportAssist Pre-boot System Performance Check diagnostics
- Diagnostic LED behavior
- Diagnostic error messages
- System error messages
- WiFi power cycle

Dell SupportAssist Pre-boot System Performance Check diagnostics

About this task

SupportAssist diagnostics (also known as system diagnostics) performs a complete check of your hardware. The Dell SupportAssist Pre-boot System Performance Check diagnostics is embedded with the BIOS and is launched by the BIOS internally. The embedded system diagnostics provides a set of options for particular devices or device groups allowing you to:

- Run tests automatically or in an interactive mode
- Repeat tests
- Display or save test results
- Run thorough tests to introduce additional test options to provide extra information about the failed device(s)
- View status messages that inform you if tests are completed successfully
- View error messages that inform you of problems encountered during testing

 **NOTE:** Some tests for specific devices require user interaction. Always ensure that you are present at the computer terminal when the diagnostic tests are performed.

For more information, see [Resolve Hardware Issues With Built-in and Online Diagnostics \(SupportAssist ePSA, ePSA or PSA Error Codes\)](#).

Running the SupportAssist Pre-Boot System Performance Check

Steps

1. Turn on your computer.
2. As the computer boots, press the F12 key as the Dell logo appears.
3. On the boot menu screen, select the **Diagnostics** option.
4. Click the arrow at the bottom left corner.
Diagnostics front page is displayed.
5. Click the arrow in the lower-right corner to go to the page listing.
The items detected are listed.
6. To run a diagnostic test on a specific device, press Esc and click **Yes** to stop the diagnostic test.
7. Select the device from the left pane and click **Run Tests**.
8. If there are any issues, error codes are displayed.
Note the error code and validation number and contact Dell.

Diagnostic LED behavior

Table 20. Diagnostic LED behavior

Blinking pattern		Problem description	Suggested resolution
Amber	White		
1	2	Unrecoverable SPI Flash Failure	
2	1	CPU failure	<ul style="list-style-type: none"> Run the Dell Support Assist/Dell Diagnostics tool. If problem persists, replace the system board.
2	2	System board failure (included BIOS corruption or ROM error)	<ul style="list-style-type: none"> Flash latest BIOS version If problem persists, replace the system board.
2	3	No memory/RAM detected	<ul style="list-style-type: none"> Confirm that the memory module is installed properly. If problem persists, replace the memory module.
2	4	Memory/RAM failure	<ul style="list-style-type: none"> Reset the memory module. If problem persists, replace the memory module.
2	5	Invalid memory installed	<ul style="list-style-type: none"> Reset the memory module. If problem persists, replace the memory module.
2	6	System board / Chipset Error / Clock failure / Gate A20 failure / Super I/O failure / Keyboard controller failure	<ul style="list-style-type: none"> Flash latest BIOS version If problem persists, replace the system board.
3	1	CMOS battery failure	<ul style="list-style-type: none"> Reset the CMOS battery connection. If problem persists, replace the RTS battery.
3	2	PCI or Video card/chip failure	Replace the system board.
3	3	BIOS Recovery image not found	<ul style="list-style-type: none"> Flash latest BIOS version If problem persists, replace the system board.
3	4	BIOS Recovery image found but invalid	<ul style="list-style-type: none"> Flash latest BIOS version If problem persists, replace the system board.
3	5	Power rail failure	<ul style="list-style-type: none"> EC ran into power sequencing failure. If problem persists, replace the system board.
3	6	SBIOS Flash corruption	<ul style="list-style-type: none"> Flash corruption detected by SBIOS

Table 20. Diagnostic LED behavior (continued)

Blinking pattern		Problem description	Suggested resolution
Amber	White		
			<ul style="list-style-type: none"> If problem persists, replace the system board.
3	7	Intel ME (Management Engine) Error	<ul style="list-style-type: none"> Timeout waiting on ME to reply to HECI message If problem persists, replace the system board.
4	2	CPU Power Cable Connection Issue	

Diagnostic error messages

Table 21. Diagnostic error messages

Error messages	Description
AUXILIARY DEVICE FAILURE	The touchpad or external mouse may be faulty. For an external mouse, check the cable connection. Enable the Pointing Device option in the System Setup program.
BAD COMMAND OR FILE NAME	Ensure that you have spelled the command correctly, put spaces in the proper place, and used the correct path name.
CACHE DISABLED DUE TO FAILURE	The primary cache internal to the microprocessor has failed. Contact Dell
CD DRIVE CONTROLLER FAILURE	The optical drive does not respond to commands from the computer.
DATA ERROR	The hard drive cannot read the data.
DECREASING AVAILABLE MEMORY	One or more memory modules may be faulty or improperly seated. Reinstall the memory modules or, if necessary, replace them.
DISK C: FAILED INITIALIZATION	The hard drive failed initialization. Run the hard drive tests in Dell Diagnostics .
DRIVE NOT READY	The operation requires a hard drive in the bay before it can continue. Install a hard drive in the hard drive bay.
ERROR READING PCMCIA CARD	The computer cannot identify the ExpressCard. Reinsert the card or try another card.
EXTENDED MEMORY SIZE HAS CHANGED	The amount of memory recorded in non-volatile memory (NVRAM) does not match the memory module installed in the computer. Restart the computer. If the error appears again, Contact Dell
THE FILE BEING COPIED IS TOO LARGE FOR THE DESTINATION DRIVE	The file that you are trying to copy is too large to fit on the disk, or the disk is full. Try copying the file to a different disk or use a larger capacity disk.
A FILENAME CANNOT CONTAIN ANY OF THE FOLLOWING CHARACTERS: \ / : * ? " < > -	Do not use these characters in filenames.
GATE A20 FAILURE	A memory module may be loose. Reinstall the memory module or, if necessary, replace it.
GENERAL FAILURE	The operating system is unable to carry out the command. The message is usually followed by specific information.

Table 21. Diagnostic error messages (continued)

Error messages	Description
	For example, Printer out of paper. Take the appropriate action.
HARD-DISK DRIVE CONFIGURATION ERROR	The computer cannot identify the drive type. Shut down the computer, remove the hard drive, and boot the computer from an optical drive. Then, shut down the computer, reinstall the hard drive, and restart the computer. Run the Hard Disk Drive tests in Dell Diagnostics .
HARD-DISK DRIVE CONTROLLER FAILURE 0	The hard drive does not respond to commands from the computer. Shut down the computer, remove the hard drive, and boot the computer from an optical drive. Then, shut down the computer, reinstall the hard drive, and restart the computer. If the problem persists, try another drive. Run the Hard Disk Drive tests in Dell Diagnostics .
HARD-DISK DRIVE FAILURE	The hard drive does not respond to commands from the computer. Shut down the computer, remove the hard drive, and boot the computer from an optical drive. Then, shut down the computer, reinstall the hard drive, and restart the computer. If the problem persists, try another drive. Run the Hard Disk Drive tests in Dell Diagnostics .
HARD-DISK DRIVE READ FAILURE	The hard drive may be defective. Shut down the computer, remove the hard drive, and boot the computer from an optical. Then, shut down the computer, reinstall the hard drive, and restart the computer. If the problem persists, try another drive. Run the Hard Disk Drive tests in Dell Diagnostics .
INSERT BOOTABLE MEDIA	The operating system is trying to boot to non-bootable media, such as an optical drive. Insert bootable media.
INVALID CONFIGURATION INFORMATION-PLEASE RUN SYSTEM SETUP PROGRAM	The system configuration information does not match the hardware configuration. The message is most likely to occur after a memory module is installed. Correct the appropriate options in the system setup program.
KEYBOARD CLOCK LINE FAILURE	For external keyboards, check the cable connection. Run the Keyboard Controller test in Dell Diagnostics .
KEYBOARD CONTROLLER FAILURE	For external keyboards, check the cable connection. Restart the computer, and avoid touching the keyboard or the mouse during the boot routine. Run the Keyboard Controller test in Dell Diagnostics .
KEYBOARD DATA LINE FAILURE	For external keyboards, check the cable connection. Run the Keyboard Controller test in Dell Diagnostics .
KEYBOARD STUCK KEY FAILURE	For external keyboards or keypads, check the cable connection. Restart the computer, and avoid touching the keyboard or keys during the boot routine. Run the Stuck Key test in Dell Diagnostics .
LICENSED CONTENT IS NOT ACCESSIBLE IN MEDIADIRECT	Dell MediaDirect cannot verify the Digital Rights Management (DRM) restrictions on the file, so the file cannot be played.
MEMORY ADDRESS LINE FAILURE AT ADDRESS, READ VALUE EXPECTING VALUE	A memory module may be faulty or improperly seated. Reinstall the memory module or, if necessary, replace it.
MEMORY ALLOCATION ERROR	The software you are attempting to run is conflicting with the operating system, another program, or a utility. Shut down the computer, wait for 30 seconds, and then restart it. Run the program again. If the error message still appears, see the software documentation.

Table 21. Diagnostic error messages (continued)

Error messages	Description
MEMORY DOUBLE WORD LOGIC FAILURE AT ADDRESS, READ VALUE EXPECTING VALUE	A memory module may be faulty or improperly seated. Reinstall the memory module or, if necessary, replace it.
MEMORY ODD/EVEN LOGIC FAILURE AT ADDRESS, READ VALUE EXPECTING VALUE	A memory module may be faulty or improperly seated. Reinstall the memory module or, if necessary, replace it.
MEMORY WRITE/READ FAILURE AT ADDRESS, READ VALUE EXPECTING VALUE	A memory module may be faulty or improperly seated. Reinstall the memory module or, if necessary, replace it.
NO BOOT DEVICE AVAILABLE	The computer cannot find the hard drive. If the hard drive is your boot device, ensure that the drive is installed, properly seated, and partitioned as a boot device.
NO BOOT SECTOR ON HARD DRIVE	The operating system may be corrupted, Contact Dell.
NO TIMER TICK INTERRUPT	A chip on the system board may be malfunctioning. Run the System Set tests in Dell Diagnostics.
NOT ENOUGH MEMORY OR RESOURCES. EXIT SOME PROGRAMS AND TRY AGAIN	You have too many programs open. Close all windows and open the program that you want to use.
OPERATING SYSTEM NOT FOUND	Reinstall the operating system. If the problem persists, Contact Dell.
OPTIONAL ROM BAD CHECKSUM	The optional ROM has failed. Contact Dell.
SECTOR NOT FOUND	The operating system cannot locate a sector on the hard drive. You may have a defective sector or corrupted File Allocation Table (FAT) on the hard drive. Run the Windows error-checking utility to check the file structure on the hard drive. See Windows Help and Support for instructions (click Start > Help and Support). If a large number of sectors are defective, back up the data (if possible), and then format the hard drive.
SEEK ERROR	The operating system cannot find a specific track on the hard drive.
SHUTDOWN FAILURE	A chip on the system board may be malfunctioning. Run the System Set tests in Dell Diagnostics. If the message reappears, Contact Dell.
TIME-OF-DAY CLOCK LOST POWER	System configuration settings are corrupted. Connect your computer to an electrical outlet to charge the battery. If the problem persists, try to restore the data by entering the System Setup program, then immediately exit the program. If the message reappears, Contact Dell.
TIME-OF-DAY CLOCK STOPPED	The reserve battery that supports the system configuration settings may require recharging. Connect your computer to an electrical outlet to charge the battery. If the problem persists, Contact Dell.
TIME-OF-DAY NOT SET-PLEASE RUN THE SYSTEM SETUP PROGRAM	The time or date stored in the system setup program does not match the system clock. Correct the settings for the Date and Time options.
TIMER CHIP COUNTER 2 FAILED	A chip on the system board may be malfunctioning. Run the System Set tests in Dell Diagnostics.
UNEXPECTED INTERRUPT IN PROTECTED MODE	The keyboard controller may be malfunctioning, or a memory module may be loose. Run the System Memory tests and the Keyboard Controller test in Dell Diagnostics or Contact Dell.
X:\ IS NOT ACCESSIBLE. THE DEVICE IS NOT READY	Insert a disk into the drive and try again.

System error messages

Table 22. System error messages

System message	Description
Alert! Previous attempts at booting this system have failed at checkpoint [nnnn]. For help in resolving this problem, please note this checkpoint and contact Dell Technical Support	The computer failed to complete the boot routine three consecutive times for the same error.
CMOS checksum error	RTC is reset, BIOS Setup default has been loaded.
CPU fan failure	CPU fan has failed.
System fan failure	System fan has failed.
Hard-disk drive failure	Possible hard disk drive failure during POST.
Keyboard failure	Keyboard failure or loose cable. If reseating the cable does not solve the problem, replace the keyboard.
No boot device available	No bootable partition on hard disk drive, the hard disk drive cable is loose, or no bootable device exists. <ul style="list-style-type: none"> • If the hard drive is your boot device, ensure that the cables are connected and that the drive is installed properly and partitioned as a boot device. • Enter system setup and ensure that the boot sequence information is correct.
No timer tick interrupt	A chip on the system board might be malfunctioning or motherboard failure.
NOTICE - Hard Drive SELF MONITORING SYSTEM has reported that a parameter has exceeded its normal operating range. Dell recommends that you back up your data regularly. A parameter out of range may or may not indicate a potential hard drive problem	S.M.A.R.T error, possible hard disk drive failure.

WiFi power cycle

About this task

If your computer is unable to access the internet due to WiFi connectivity issues a WiFi power cycle procedure may be performed. The following procedure provides the instructions on how to conduct a WiFi power cycle:

 **NOTE:** Some ISPs (Internet Service Providers) provide a modem/router combo device.

Steps



1. Turn off your computer.
2. Turn off the modem.
3. Turn off the wireless router.
4. Wait for 30 seconds.
5. Turn on the wireless router.
6. Turn on the modem.
7. Turn on your computer.

Getting help and contacting Dell

Self-help resources

You can get information and help on Dell products and services using these self-help resources:

Table 23. Self-help resources

Self-help resources	Resource location
Information about Dell products and services	www.dell.com
My Dell	
Tips	
Contact Support	In Windows search, type <code>Contact Support</code> , and press Enter.
Online help for operating system	www.dell.com/support/windows www.dell.com/support/linux
Access top solutions, diagnostics, drivers and downloads, and learn more about your computer through videos, manuals and documents.	Your Dell computer is uniquely identified by a Service Tag or Express Service Code. To view relevant support resources for your Dell computer, enter the Service Tag or Express Service Code at www.dell.com/support . For more information on how to find the Service Tag for your computer, see Locate the Service Tag on your computer .
Dell knowledge base articles for a variety of computer concerns	<ol style="list-style-type: none"> 1. Go to www.dell.com/support. 2. On the menu bar at the top of the Support page, select Support > Knowledge Base. 3. In the Search field on the Knowledge Base page, type the keyword, topic, or model number, and then click or tap the search icon to view the related articles.

Contacting Dell

To contact Dell for sales, technical support, or customer service issues, see www.dell.com/contactdell.

 **NOTE:** Availability varies by country/region and product, and some services may not be available in your country/region.

 **NOTE:** If you do not have an active Internet connection, you can find contact information about your purchase invoice, packing slip, bill, or Dell product catalog.