

Latitude 9520

Service Manual

Notes, cautions, and warnings

 **NOTE:** A NOTE indicates important information that helps you make better use of your product.

 **CAUTION:** A CAUTION indicates either potential damage to hardware or loss of data and tells you how to avoid the problem.

 **WARNING:** A WARNING indicates a potential for property damage, personal injury, or death.

| | |
|--|-----------|
| Chapter 1: Working on your computer | 6 |
| Safety instructions..... | 6 |
| Before working inside your computer..... | 6 |
| Service mode..... | 7 |
| Safety precautions..... | 8 |
| Electrostatic discharge—ESD protection..... | 9 |
| ESD field service kit | 9 |
| After working inside your computer..... | 10 |
| Chapter 2: Removing and installing components | 11 |
| Recommended tools..... | 11 |
| Screw list..... | 11 |
| Major components of your system..... | 13 |
| SIM card tray..... | 14 |
| Removing the SIM card tray..... | 14 |
| Installing the SIM card tray..... | 15 |
| MicroSD card..... | 16 |
| Removing the microSD card..... | 16 |
| Installing the Micro-SD card..... | 16 |
| Base cover..... | 17 |
| Removing the base cover..... | 17 |
| Installing the base cover..... | 19 |
| WWAN card..... | 20 |
| Removing the WWAN card..... | 20 |
| Installing the WWAN card..... | 21 |
| Solid-state drive..... | 23 |
| Removing the solid-state drive..... | 23 |
| Installing the solid-state drive..... | 24 |
| Speakers..... | 25 |
| Removing the speaker..... | 25 |
| Installing the speaker..... | 26 |
| System fan..... | 28 |
| Removing the system fan..... | 28 |
| Installing the system fan..... | 28 |
| I/O daughter board power cable..... | 29 |
| Removing the I/O daughter board cable..... | 29 |
| Installing the I/O daughter board cable..... | 30 |
| I/O daughter board..... | 31 |
| Removing the I/O daughter board..... | 31 |
| Installing the I/O board..... | 32 |
| Power button..... | 33 |
| Removing the power button | 33 |
| Installing the power button | 34 |
| Power button with finger print reader (optional)..... | 35 |

| | |
|--|-----------|
| Removing the power button with fingerprint reader..... | 35 |
| Installing the power button with fingerprint reader..... | 36 |
| Battery..... | 37 |
| Lithium-ion battery precautions..... | 37 |
| Removing the 4-cell battery..... | 38 |
| Installing the 4-cell battery..... | 39 |
| Removing the 6-cell battery..... | 41 |
| Installing the 6-cell battery..... | 41 |
| Smart card reader..... | 42 |
| Removing the smart card reader..... | 42 |
| Installing the smart card reader..... | 43 |
| System board..... | 45 |
| Removing the system board..... | 45 |
| Installing the system board..... | 47 |
| Display assembly..... | 50 |
| Removing the display assembly..... | 50 |
| Installing the display assembly..... | 53 |
| Keyboard..... | 55 |
| Removing the keyboard..... | 55 |
| Installing the keyboard..... | 58 |
| Palmrest assembly..... | 60 |
| Removing the palmrest assembly..... | 60 |
| Chapter 3: Software..... | 62 |
| Drivers and downloads..... | 62 |
| Operating system..... | 62 |
| Chapter 4: System setup..... | 63 |
| Boot menu..... | 63 |
| Entering BIOS setup program..... | 64 |
| Navigation keys..... | 64 |
| Boot Sequence..... | 64 |
| System setup options..... | 64 |
| Overview..... | 64 |
| Boot Configuration..... | 66 |
| Integrated Devices..... | 67 |
| Storage..... | 68 |
| Display..... | 69 |
| Connection..... | 70 |
| Power..... | 70 |
| Security..... | 72 |
| Passwords..... | 74 |
| Update Recovery..... | 75 |
| System Management..... | 76 |
| Keyboard..... | 77 |
| Pre-boot Behavior..... | 78 |
| Virtualization..... | 79 |
| Performance..... | 79 |
| System Logs..... | 80 |

| | |
|---|-----------|
| Updating the BIOS..... | 81 |
| Updating the BIOS in Windows..... | 81 |
| Updating the BIOS in Linux and Ubuntu..... | 81 |
| Updating the BIOS using the USB drive in Windows..... | 81 |
| Updating the BIOS from the F12 One-Time boot menu..... | 82 |
| System and setup password..... | 83 |
| Assigning a system setup password..... | 83 |
| Deleting or changing an existing system setup password..... | 83 |
| Chapter 5: Troubleshooting..... | 85 |
| Handling swollen Lithium-ion batteries..... | 85 |
| Dell SupportAssist Pre-boot System Performance Check diagnostics..... | 86 |
| Running the SupportAssist Pre-Boot System Performance Check..... | 86 |
| Diagnostics..... | 86 |
| Recovering the operating system..... | 88 |
| Diagnostic error messages..... | 88 |
| System error messages..... | 91 |
| Backup media and recovery options..... | 91 |
| Wi-Fi power cycle..... | 92 |
| Chapter 6: Getting help and contacting Dell..... | 93 |

Working on your computer

Topics:

- [Safety instructions](#)

Safety instructions

Use the following safety guidelines to protect your computer from potential damage and to ensure your personal safety. Unless otherwise noted, each procedure included in this document assumes that you have read the safety information that shipped with your computer.

⚠ WARNING: Before working inside your computer, read the safety information that is shipped with your computer. For more safety best practices, see the Regulatory Compliance home page at www.dell.com/regulatory_compliance.

⚠ WARNING: Disconnect your computer from all power sources before opening the computer cover or panels. After you finish working inside the computer, replace all covers, panels, and screws before connecting your computer to an electrical outlet.

⚠ CAUTION: To avoid damaging the computer, ensure that the work surface is flat, dry, and clean.

⚠ CAUTION: To avoid damaging the components and cards, handle them by their edges, and avoid touching the pins and the contacts.

⚠ CAUTION: You should only perform troubleshooting and repairs as authorized or directed by the Dell technical assistance team. Damage due to servicing that is not authorized by Dell is not covered by your warranty. See the safety instructions that is shipped with the product or at www.dell.com/regulatory_compliance.

⚠ CAUTION: Before touching anything inside your computer, ground yourself by touching an unpainted metal surface, such as the metal at the back of the computer. While you work, periodically touch an unpainted metal surface to dissipate static electricity which could harm internal components.

⚠ CAUTION: When you disconnect a cable, pull it by its connector or its pull tab, not the cable itself. Some cables have connectors with locking tabs or thumbscrews that you must disengage before disconnecting the cable. When disconnecting cables, keep them evenly aligned to avoid bending the connector pins. When connecting cables, ensure that the ports and the connectors are correctly oriented and aligned.

⚠ CAUTION: Press and eject any installed card from the media-card reader.

⚠ CAUTION: Exercise caution when handling Lithium-ion batteries in laptops. Swollen batteries should not be used and should be replaced and disposed properly.

ℹ NOTE: The color of your computer and certain components may appear differently than shown in this document.

Before working inside your computer

Steps

1. Save and close all open files and exit all open applications.
2. Shut down your computer. Click **Start** > **Power** > **Shut down**.

NOTE: If you are using a different operating system, see the documentation of your operating system for shut-down instructions.

3. Disconnect your computer and all attached devices from their electrical outlets.
4. Disconnect all attached network devices and peripherals, such as keyboard, mouse, and monitor from your computer.
5. Remove any media card and optical disc from your computer, if applicable.
6. After the computer is unplugged, press and hold the power button for 5 seconds to ground the system board.

CAUTION: Place the computer on a flat, soft, and clean surface to avoid scratches on the display.

7. Place the computer face down.

Service mode

Service Mode allows users to immediately cut off power from the system without disconnecting the battery cable from the system board.

To enter the **Service Mode**:

1. Shut down the system and disconnect the AC adapter from the system.
2. Press and hold the **** key on the keyboard, and then press the power button. The system will boot up.

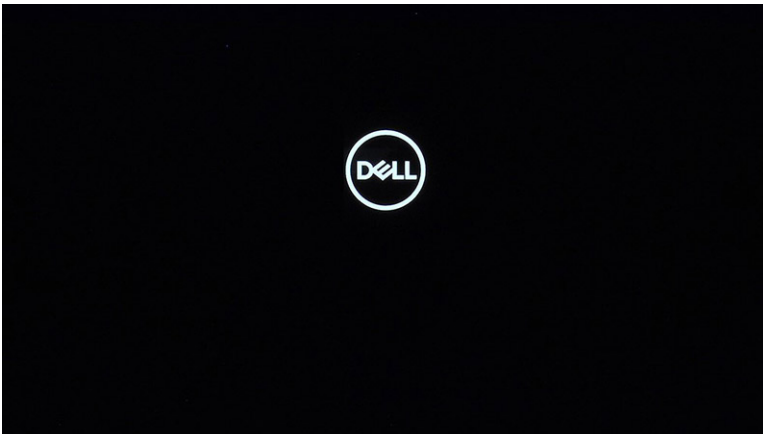

3. Press any key to proceed, when the **Owner Tag** information is displayed on the screen.

NOTE: The **Service Mode** procedure will automatically skip this step if the Owner Tag of the system is not set up in advance by the manufacturer.

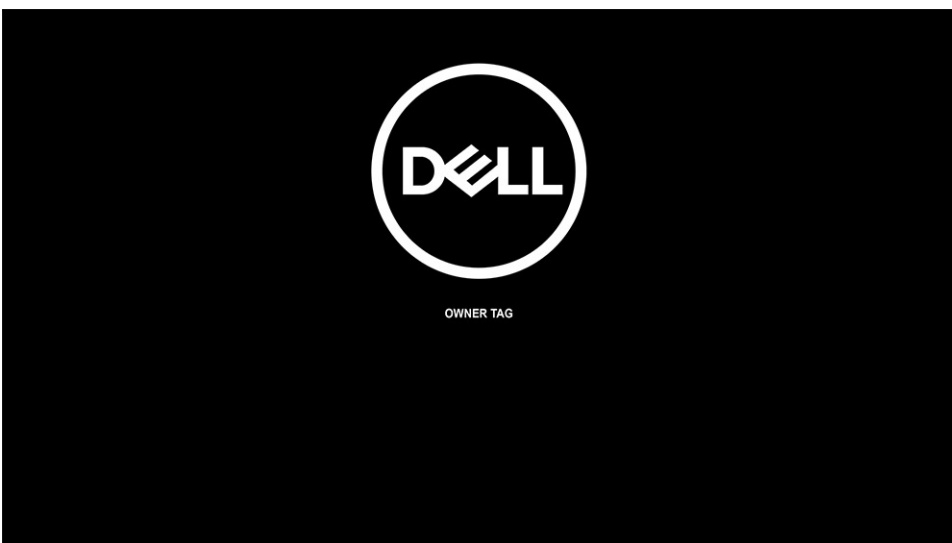

- When the ready-to-proceed message appears on the screen, press any key to proceed. The system will emit three short beeps and shut down immediately.

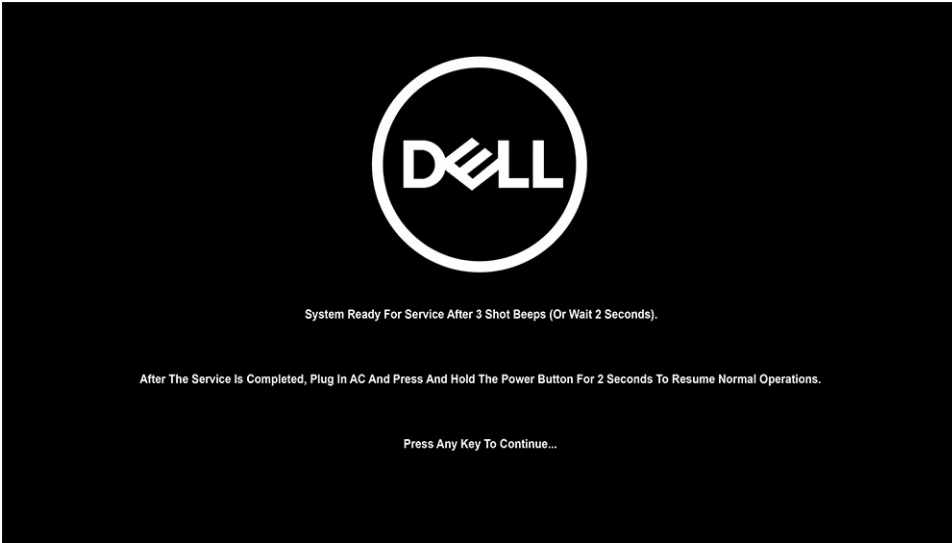

NOTE: If the AC adapter is not disconnected from the system, a message prompting you to remove the AC adapter is displayed on the screen.

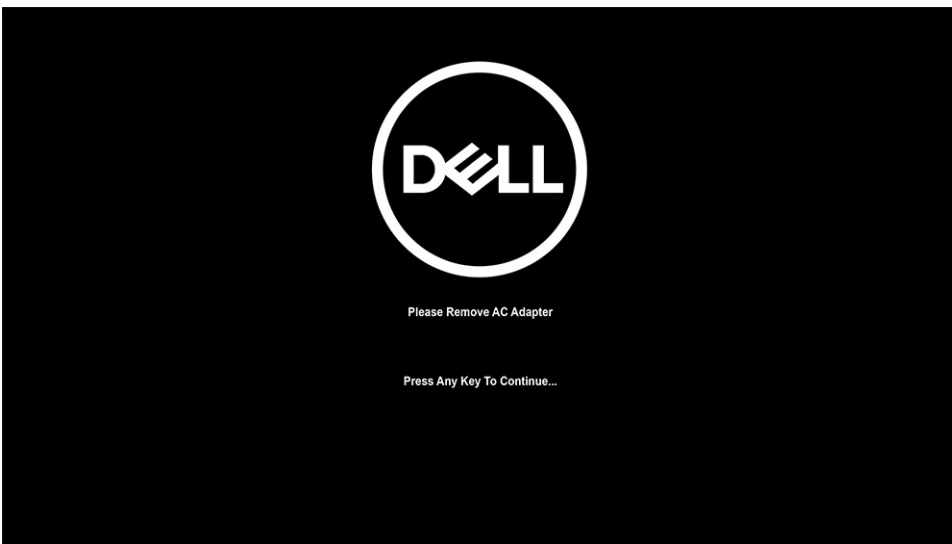

- Once the system has powered down, you can proceed to perform replacement procedures.
- To exit **Service Mode** connect the AC adapter and press the power button to power on the system. The system will boot up and return to normal functioning mode.

Safety precautions

The safety precautions chapter details the primary steps to be taken before performing any disassembly instructions.

Observe the following safety precautions before you perform any installation or break/fix procedures involving disassembly or reassembly:

- Turn off the system and all attached peripherals.
- Disconnect the system and all attached peripherals from AC power.
- Disconnect all network cables, telephone, and telecommunications lines from the system.
- Use an ESD field service kit when working inside any notebook to avoid electrostatic discharge (ESD) damage.
- After removing any system component, carefully place the removed component on an anti-static mat.
- Wear shoes with non-conductive rubber soles to reduce the chance of getting electrocuted.

Standby power

Dell products with standby power must be unplugged before you open the case. Systems that incorporate standby power are essentially powered while turned off. The internal power enables the system to be remotely turned on (wake on LAN) and suspended into a sleep mode and has other advanced power management features.

Unplugging, pressing and holding the power button for 15 seconds should discharge residual power in the system board.

Bonding

Bonding is a method for connecting two or more grounding conductors to the same electrical potential. This is done through the use of a field service electrostatic discharge (ESD) kit. When connecting a bonding wire, ensure that it is connected to bare metal and never to a painted or non-metal surface. The wrist strap should be secure and in full contact with your skin, and ensure that you remove all jewelry such as watches, bracelets, or rings prior to bonding yourself and the equipment.

Electrostatic discharge—ESD protection

ESD is a major concern when you handle electronic components, especially sensitive components such as expansion cards, processors, memory DIMMs, and system boards. Very slight charges can damage circuits in ways that may not be obvious, such as intermittent problems or a shortened product life span. As the industry pushes for lower power requirements and increased density, ESD protection is an increasing concern.

Due to the increased density of semiconductors used in recent Dell products, the sensitivity to static damage is now higher than in previous Dell products. For this reason, some previously approved methods of handling parts are no longer applicable.

Two recognized types of ESD damage are catastrophic and intermittent failures.

- **Catastrophic** – Catastrophic failures represent approximately 20 percent of ESD-related failures. The damage causes an immediate and complete loss of device functionality. An example of catastrophic failure is a memory DIMM that has received a static shock and immediately generates a "No POST/No Video" symptom with a beep code emitted for missing or nonfunctional memory.
- **Intermittent** – Intermittent failures represent approximately 80 percent of ESD-related failures. The high rate of intermittent failures means that most of the time when damage occurs, it is not immediately recognizable. The DIMM receives a static shock, but the tracing is merely weakened and does not immediately produce outward symptoms related to the damage. The weakened trace may take weeks or months to melt, and in the meantime may cause degradation of memory integrity, intermittent memory errors, etc.

Perform the following steps to prevent ESD damage:

- Use a wired ESD wrist strap that is properly grounded. The use of wireless anti-static straps is no longer allowed; they do not provide adequate protection. Touching the chassis before handling parts does not ensure adequate ESD protection on parts with increased sensitivity to ESD damage.
- Handle all static-sensitive components in a static-safe area. If possible, use anti-static floor pads and workbench pads.
- When unpacking a static-sensitive component from its shipping carton, do not remove the component from the anti-static packing material until you are ready to install the component. Before unwrapping the anti-static packaging, ensure that you discharge static electricity from your body.
- Before transporting a static-sensitive component, place it in an anti-static container or packaging.

ESD field service kit

The unmonitored Field Service kit is the most commonly used service kit. Each Field Service kit includes three main components: anti-static mat, wrist strap, and bonding wire.

Components of an ESD field service kit

The components of an ESD field service kit are:

- **Anti-Static Mat** – The anti-static mat is dissipative and parts can be placed on it during service procedures. When using an anti-static mat, your wrist strap should be snug and the bonding wire should be connected to the mat and to any bare metal on the system being worked on. Once deployed properly, service parts can be removed from the ESD bag and placed directly on the mat. ESD-sensitive items are safe in your hand, on the ESD mat, in the system, or inside a bag.
- **Wrist Strap and Bonding Wire** – The wrist strap and bonding wire can be either directly connected between your wrist and bare metal on the hardware if the ESD mat is not required, or connected to the anti-static mat to protect hardware that

is temporarily placed on the mat. The physical connection of the wrist strap and bonding wire between your skin, the ESD mat, and the hardware is known as bonding. Use only Field Service kits with a wrist strap, mat, and bonding wire. Never use wireless wrist straps. Always be aware that the internal wires of a wrist strap are prone to damage from normal wear and tear, and must be checked regularly with a wrist strap tester in order to avoid accidental ESD hardware damage. It is recommended to test the wrist strap and bonding wire at least once per week.

- **ESD Wrist Strap Tester** – The wires inside of an ESD strap are prone to damage over time. When using an unmonitored kit, it is a best practice to regularly test the strap prior to each service call, and at a minimum, test once per week. A wrist strap tester is the best method for doing this test. If you do not have your own wrist strap tester, check with your regional office to find out if they have one. To perform the test, plug the wrist-strap's bonding-wire into the tester while it is strapped to your wrist and push the button to test. A green LED is lit if the test is successful; a red LED is lit and an alarm sounds if the test fails.
- **Insulator Elements** – It is critical to keep ESD sensitive devices, such as plastic heat sink casings, away from internal parts that are insulators and often highly charged.
- **Working Environment** – Before deploying the ESD Field Service kit, assess the situation at the customer location. For example, deploying the kit for a server environment is different than for a desktop or portable environment. Servers are typically installed in a rack within a data center; desktops or portables are typically placed on office desks or cubicles. Always look for a large open flat work area that is free of clutter and large enough to deploy the ESD kit with additional space to accommodate the type of system that is being repaired. The workspace should also be free of insulators that can cause an ESD event. On the work area, insulators such as Styrofoam and other plastics should always be moved at least 12 inches or 30 centimeters away from sensitive parts before physically handling any hardware components
- **ESD Packaging** – All ESD-sensitive devices must be shipped and received in static-safe packaging. Metal, static-shielded bags are preferred. However, you should always return the damaged part using the same ESD bag and packaging that the new part arrived in. The ESD bag should be folded over and taped shut and all the same foam packing material should be used in the original box that the new part arrived in. ESD-sensitive devices should be removed from packaging only at an ESD-protected work surface, and parts should never be placed on top of the ESD bag because only the inside of the bag is shielded. Always place parts in your hand, on the ESD mat, in the system, or inside an anti-static bag.
- **Transporting Sensitive Components** – When transporting ESD sensitive components such as replacement parts or parts to be returned to Dell, it is critical to place these parts in anti-static bags for safe transport.

ESD protection summary

It is recommended that all field service technicians use the traditional wired ESD grounding wrist strap and protective anti-static mat at all times when servicing Dell products. In addition, it is critical that technicians keep sensitive parts separate from all insulator parts while performing service and that they use anti-static bags for transporting sensitive components.

After working inside your computer

About this task

 **NOTE:** Leaving stray or loose screws inside your computer may severely damage your computer.

Steps

1. Replace all screws and ensure that no stray screws remain inside your computer.
2. Connect any external devices, peripherals, or cables you removed before working on your computer.
3. Replace any media cards, discs, or any other parts that you removed before working on your computer.
4. Connect your computer and all attached devices to their electrical outlets.
5. Turn on your computer.

Removing and installing components

Topics:

- Recommended tools
- Screw list
- Major components of your system
- SIM card tray
- MicroSD card
- Base cover
- WWAN card
- Solid-state drive
- Speakers
- System fan
- I/O daughter board power cable
- I/O daughter board
- Power button
- Power button with finger print reader (optional)
- Battery
- Smart card reader
- System board
- Display assembly
- Keyboard
- Palmrest assembly

Recommended tools

The procedures in this document may require the following tools:

- Phillips screwdriver #1
- Plastic scribe

Screw list

- NOTE:** When removing screws from a component, it is recommended to note the screw type, the quantity of screws, and then place them in a screw storage box. This is to ensure that the correct number of screws and correct screw type is restored when the component is replaced.
- NOTE:** Some systems have magnetic surfaces. Ensure that the screws are not left attached to such surface when replacing a component.
- NOTE:** Screw color may vary with the configuration ordered.

Table 1. Latitude 9520 screw list

| Component | Screw type | Quantity | Image |
|------------|----------------|----------|---|
| Base cover | Captive screws | 9 |  |

Table 1. Latitude 9520 screw list (continued)























| Component | Screw type | Quantity | Image |
|--------------------------------------|---------------|----------|---|
| 4-cell battery | M1.6x3.5 | 1 |  |
| | M2x3 | 4 |  |
| 6-cell battery | M1.6x3.5 | 1 |  |
| | M2x3 | 8 |  |
| WWAN | Captive screw | 1 |  |
| Smart card reader | M2x2 | 2 |  |
| Solid-state drive | M2x2 | 1 |  |
| Speaker | M1.6x1.8 | 4 |  |
| I/O board | M1.6x3.5 | 4 |  |
| System fan | M2x3 | 3 |  |
| Display cable bracket | M1.6x3.5 | 1 |  |
| Display assembly | M2.5x5 | 6 |  |
| | M1.6x3.5 | 1 |  |
| Power button | M1.5x2.5 | 3 |  |
| | M2.5x5 | 3 |  |
| Power button with fingerprint reader | M1.5x2.5 | 3 |  |
| | M2.5x5 | 3 |  |
| System board | M1.6x3.5 | 9 |  |

Table 1. Latitude 9520 screw list (continued)

| Component | Screw type | Quantity | Image |
|-----------|------------|----------|---|
| | M2.5x5 | 2 |  |
| | M1.6x4.5 | 1 |  |
| Keyboard | M1.6x2 | 4 |  |
| | M1.6x1.5 | 36 |  |

Major components of your system

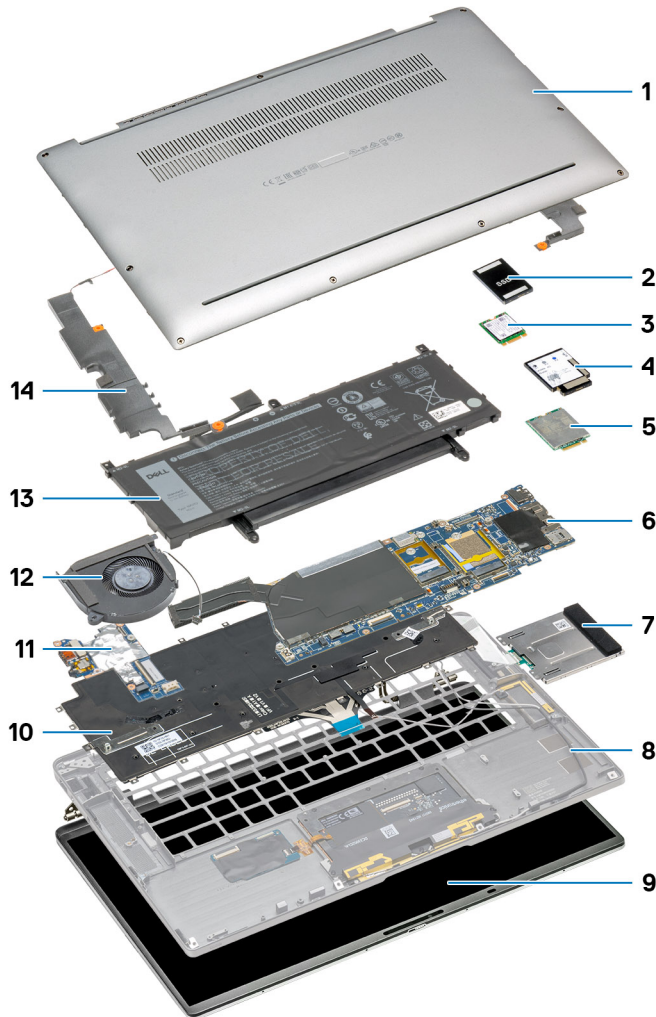

1. Base cover
2. Solid-state drive shield
3. Solid-State drive
4. WWAN shield
5. WWAN Card
6. System board

7. Smart card reader
8. Palmrest
9. Display assembly
10. Keyboard
11. I/O board
12. System fan
13. Battery
14. Speakers

SIM card tray

Removing the SIM card tray

Prerequisites

Follow the procedure in [before working inside your computer](#).

About this task

The following image provides a visual representation of the SIM card tray removal procedure.

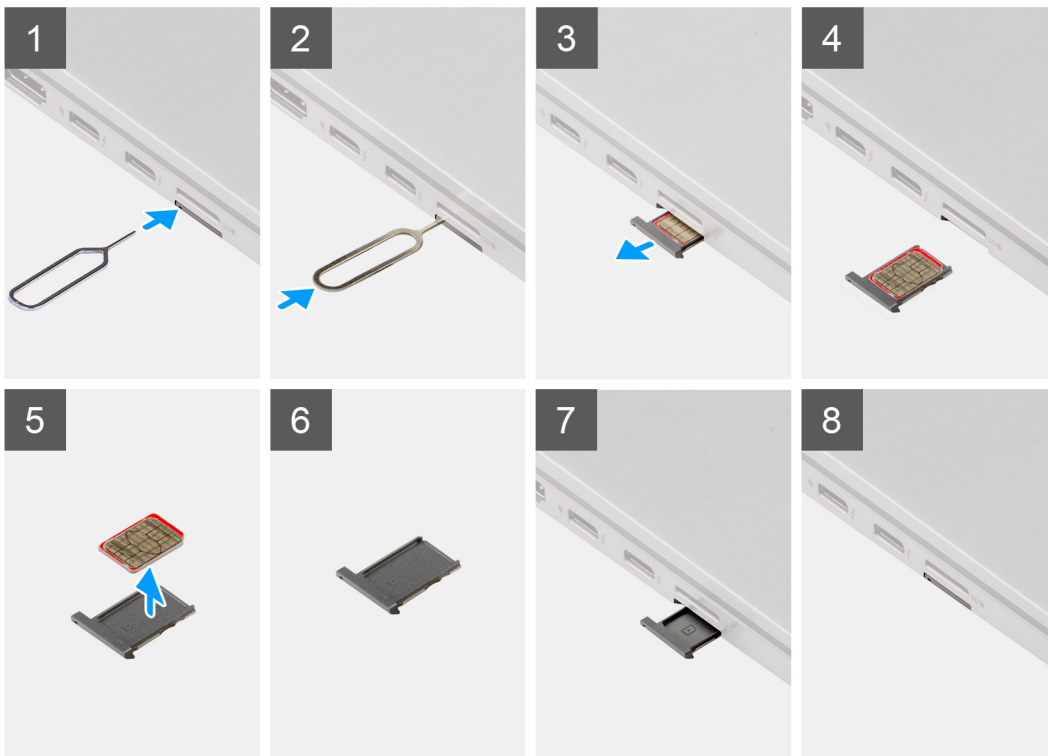

Steps

1. Insert the SIM card removal pin into the release hole to release the SIM card tray.

2. Push the pin to disengage the lock, and eject the SIM card tray.
3. Slide the SIM card tray out of the slot on the system.
4. Remove the Micro-SIM from the SIM tray.
5. Slide the SIM card tray back into the slot on the system.

Installing the SIM card tray

Prerequisites

If you are replacing a component, remove the necessary component before the installation procedure.

About this task

The following image provides a visual representation of the SIM card tray installation procedure.

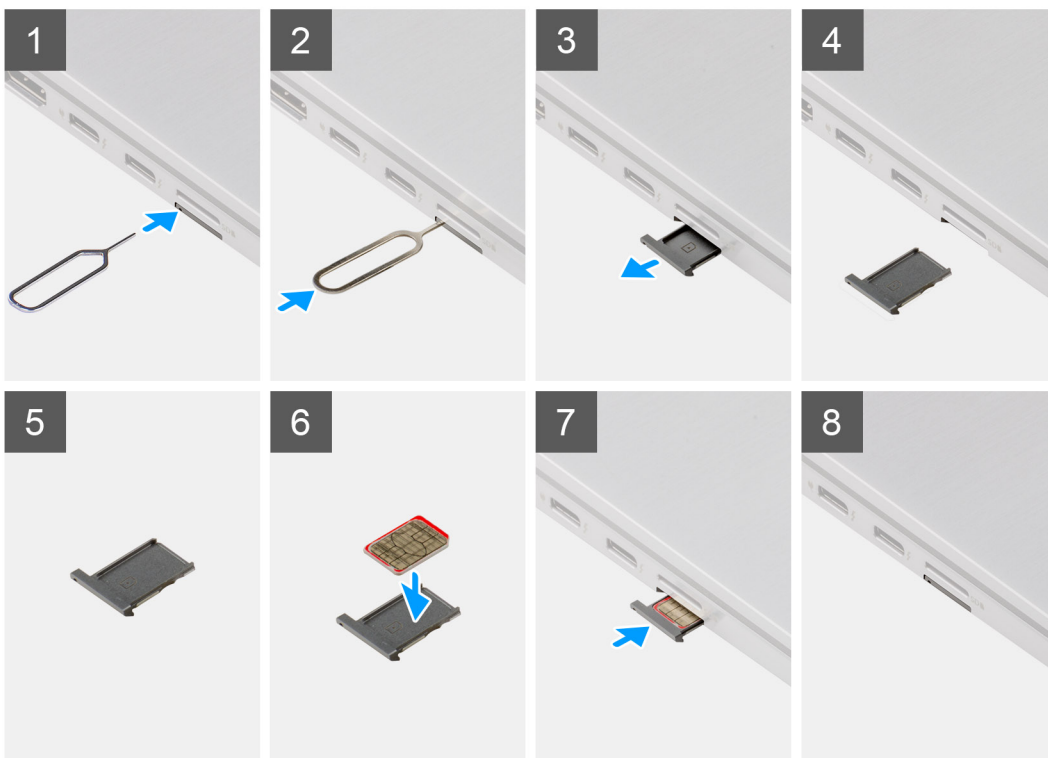

Steps

1. Insert the SIM card removal pin into the release hole to remove the SIM card tray.
2. Push the pin to disengage the lock, and eject the SIM card tray.
3. Slide the SIM card tray out of the slot on the system.
4. Align and place the Micro-SIM card in the dedicated slot on the SIM card tray.
5. Slide the SIM card tray back into the slot on the system.

Next steps

Follow the procedure in [After working on your computer.](#)

MicroSD card

Removing the microSD card

Prerequisites

Follow the procedure in [before working inside your computer.](#)

About this task

The following image provides a visual representation of the microSD card removal procedure.



Steps

1. Push the microSD card to eject it from the slot.
2. Remove the microSD card from the system.

Installing the Micro-SD card

Prerequisites

If you are replacing a component, remove the existing component before performing the installation procedure.

About this task

The following image provides a visual representation of the Micro-SD card installation procedure.



Steps

Insert the microSD card into its slot until it clicks into place.

Next steps

1. Follow the procedure in [After working on your computer](#).

Base cover

Removing the base cover

Prerequisites

1. Follow the procedure in [before working inside your computer](#).
2. Remove the [microSD card](#).
3. Remove the [SIM card tray](#).
4. Enter [service mode](#).

About this task



9x

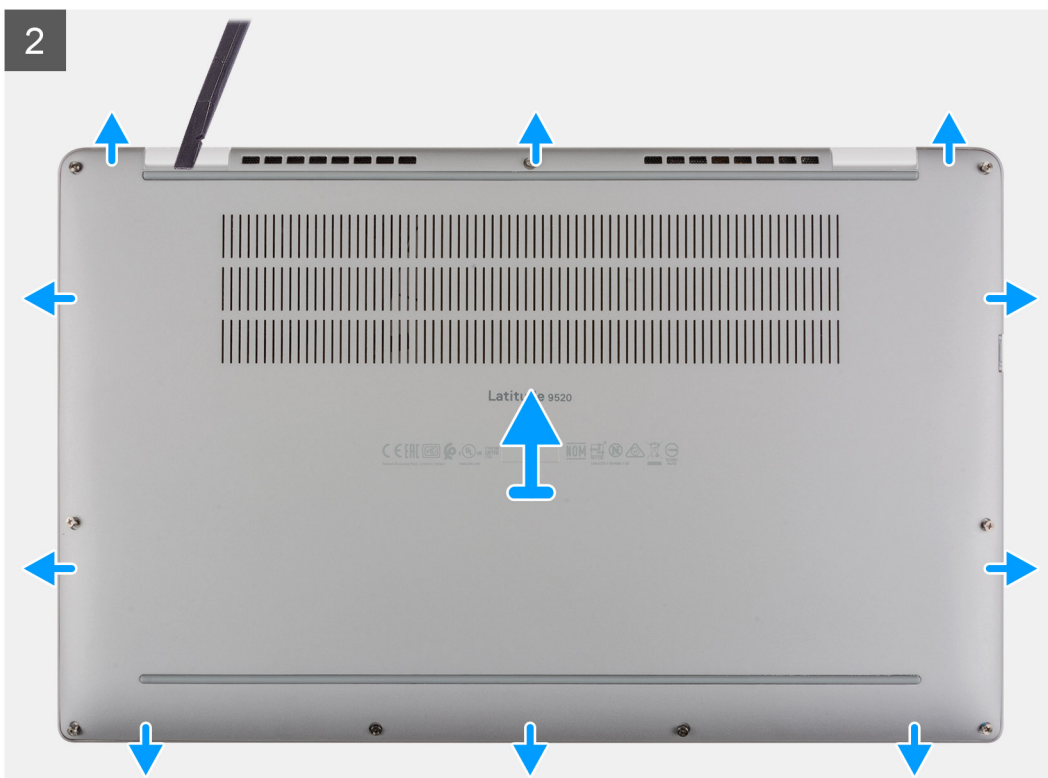

Steps

1. Loosen the nine captive screws that secure the base cover to the system.
2. Using a plastic scribe, pry open the base cover starting from the recesses located in the U-shaped indents near the hinges at the top edge of the base cover.

NOTE: Do not pull the base cover from the top side immediately after prying it from the recesses, as this will cause damage to the base cover.

3. Pry open the left and right sides of the base cover.
4. Pry open the bottom side of the base cover.
5. Hold the left and right sides of the base cover and remove it from the system.

Installing the base cover

About this task

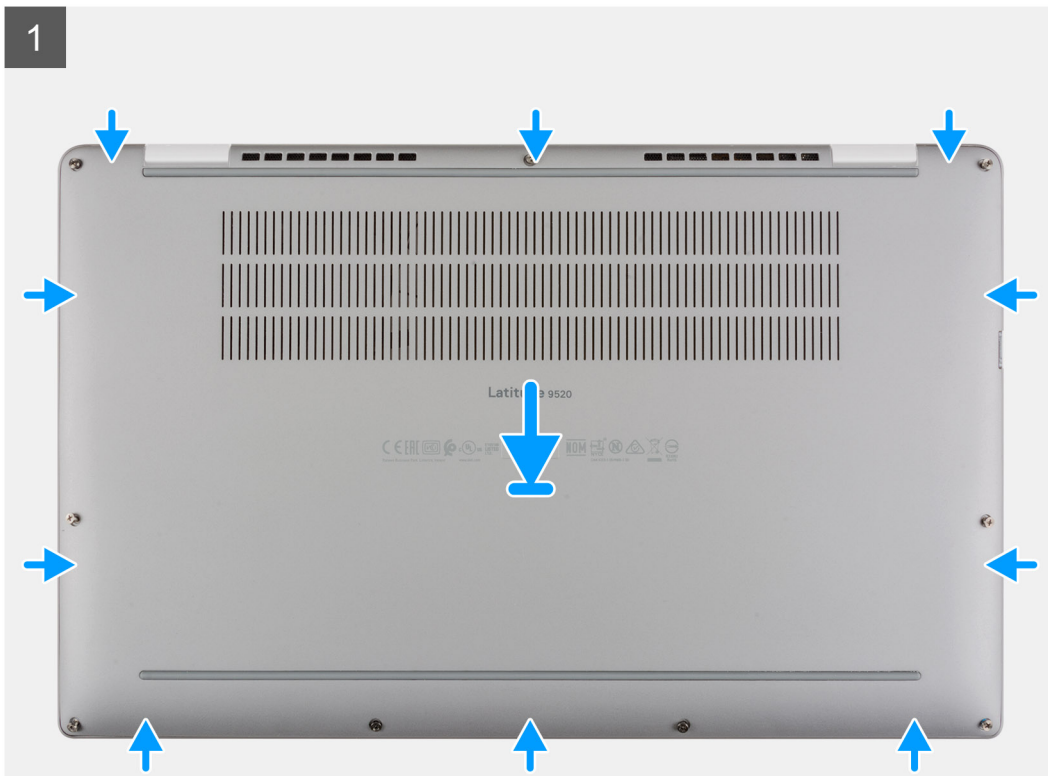



9x



Steps

1. Align and place the base cover on the palmrest and keyboard assembly, and snap the base cover into place.
2. Tighten the nine captive screws to secure the base cover to the system.

Next steps

1. Install the [SIM card tray](#).
2. Install the [microSD card](#).
3. Follow the procedure in [After working on your computer](#).

WWAN card

Removing the WWAN card

Prerequisites

1. Follow the procedure in [before working inside your computer](#).
2. Remove the [microSD card](#).
3. Remove the [SIM card tray](#).
4. Enter [service mode](#).
5. Remove the [base cover](#).

About this task

The following images indicate the location of the WWAN card and provide a visual representation of the removal procedure.

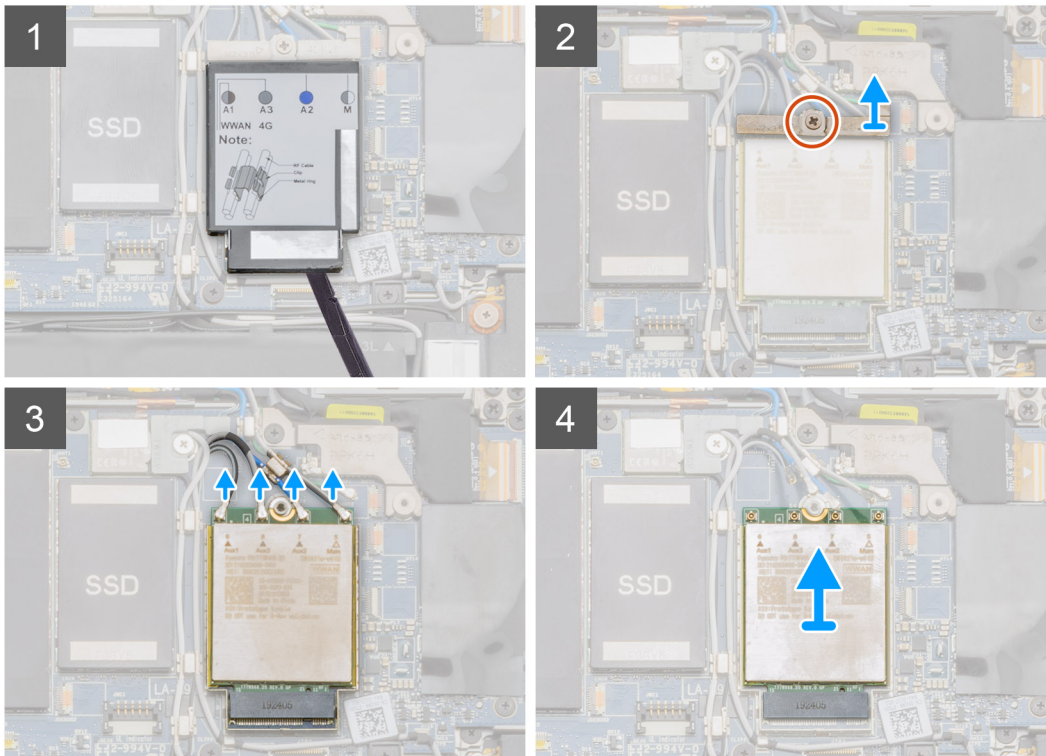
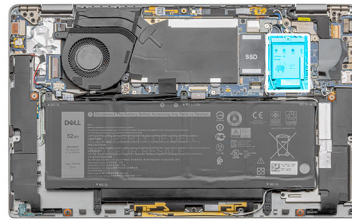

Steps

1. Using a plastic scribe, pry open the WWAN card shield covering the WWAN card.
2. Loosen the single captive screw that secures the WWAN-card bracket to the WWAN card.
3. Lift the WWAN-card bracket out of the system.
4. Disconnect the antenna cables from the connectors on the WWAN card.
5. Lift and slide the WWAN card from the WWAN-card slot.

Installing the WWAN card

Prerequisites

If you are replacing a component, remove the existing component before performing the installation procedure.

About this task

The following image indicates the location of the WWAN card and provides a visual representation of the installation procedure.

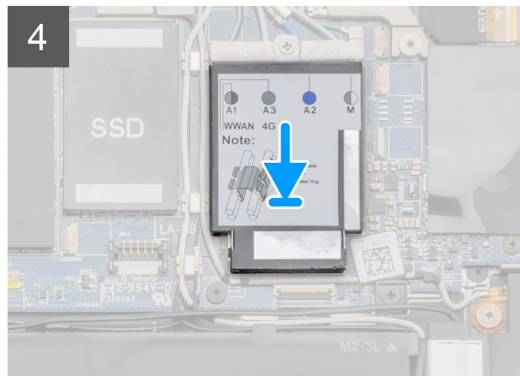
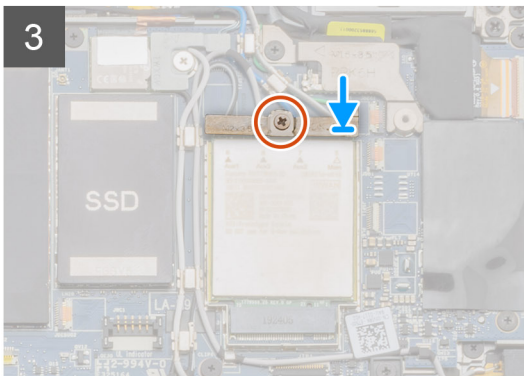
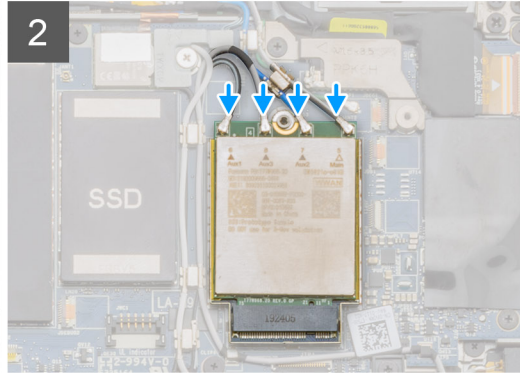
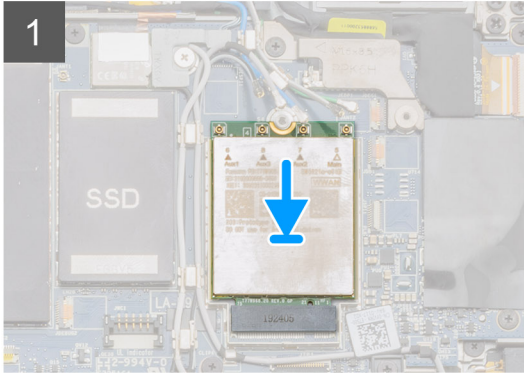
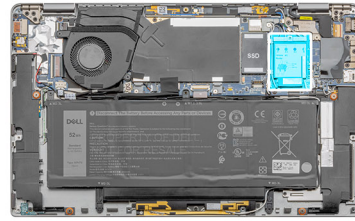

Steps

1. Align the notch on the WWAN card with the tab on the WWAN-card slot.

NOTE: If any of the thermal pads located underneath the WWAN card are detached from the system board when removing the WWAN card from the system, adhere them back on the system board.

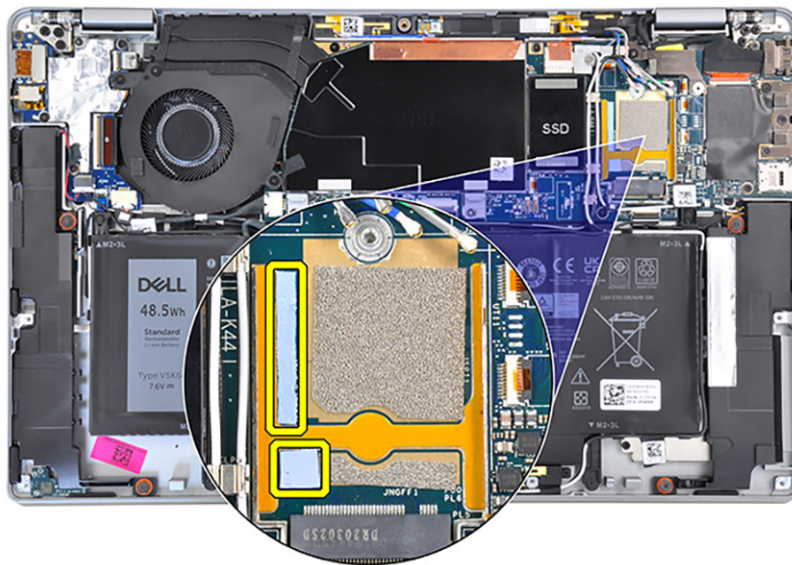

2. Slide the WWAN card at an angle into the WWAN-card slot.
3. Connect the antenna cables to the connectors on the WWAN card.
4. Align and place the WWAN-card bracket on the system board and WWAN card.
5. Push down on the WWAN card with the bracket and tighten the single captive screw.
6. Align and place the WWAN-card shield, press to fit it firmly to cover the WWAN card.

Next steps

1. Install the [base cover](#).
2. Install the [SIM card tray](#).
3. Install the [microSD card](#).
4. Follow the procedure in [After working on your computer](#).

Solid-state drive

Removing the solid-state drive

Prerequisites

1. Follow the procedure in [before working inside your computer](#).
2. Remove the [microSD card](#).
3. Remove the [SIM card tray](#).
4. Enter [service mode](#).
5. Remove the [base cover](#).

About this task

The following images indicate the location of the solid-state drive and provide a visual representation of the removal procedure.



1x
M2x2

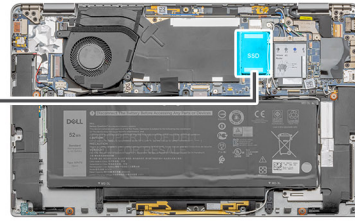

Steps

1. Using a plastic scribe, pry open the solid-state drive shield and lift it out of the system.
2. Remove the single screw (M2x2) that secures the solid-state drive to the system board.
3. Lift and slide the solid-state drive from the solid-state drive slot on the system board.

Installing the solid-state drive

Prerequisites

If you are replacing a component, remove the existing component before performing the installation procedure.

About this task

The following image indicates the location of the solid-state drive and provides a visual representation of the installation procedure.



1x
M2x2

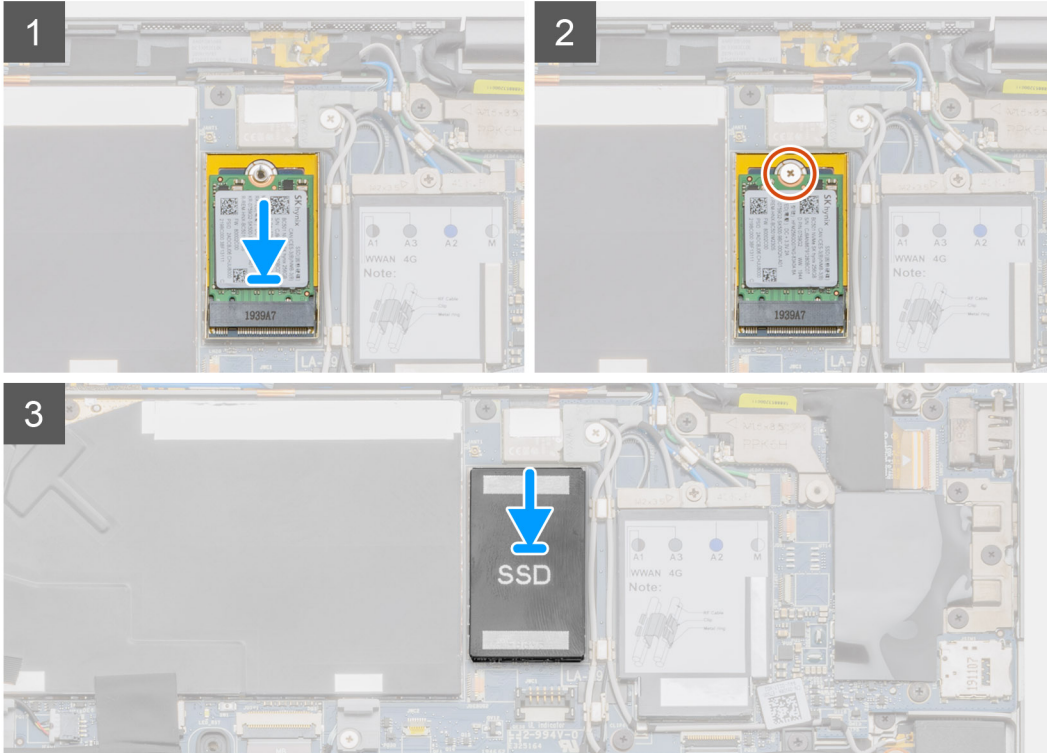
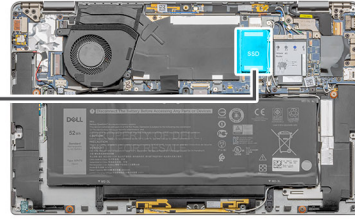

Steps

1. Align the notch on the solid-state drive with the tab on the M.2 card connector.
2. Slide the solid-state drive into the M.2 card connector on the system board.
3. Push down the solid-state drive and replace the screw (M2x2) that secures the solid-state drive to the system board.
4. Align and place the solid-state drive shield, press to fit it firmly to cover the solid-state drive.

Next steps

1. Install the [base cover](#).
2. Install the [SIM card tray](#).
3. Install the [microSD card](#).
4. Follow the procedure in [After working on your computer](#).

Speakers

Removing the speaker

Prerequisites

1. Follow the procedure in [before working inside your computer](#).
2. Remove the [microSD card](#).
3. Remove the [SIM card tray](#).

4. Enter [service mode](#).
5. Remove the [base cover](#).

About this task

The following images indicate the location of the speaker and provide a visual representation of the removal procedure.



4x
M1.6x1.8

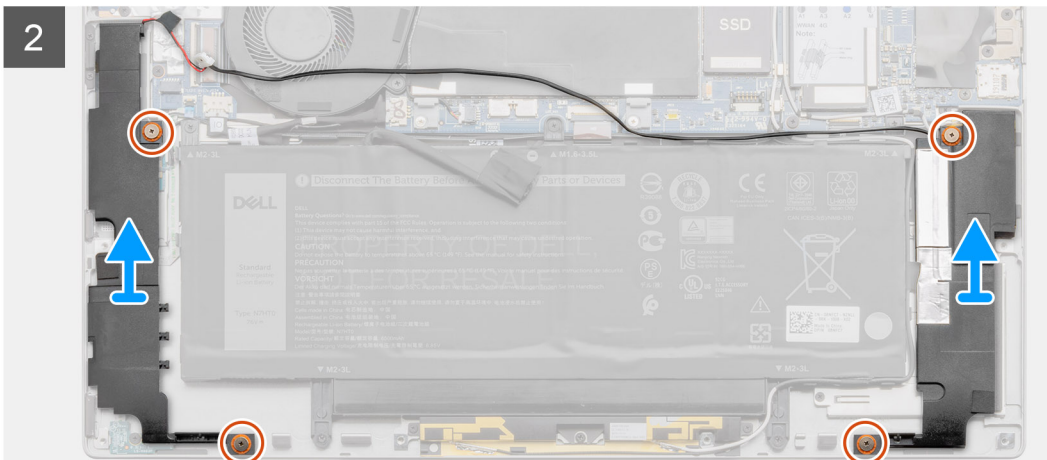
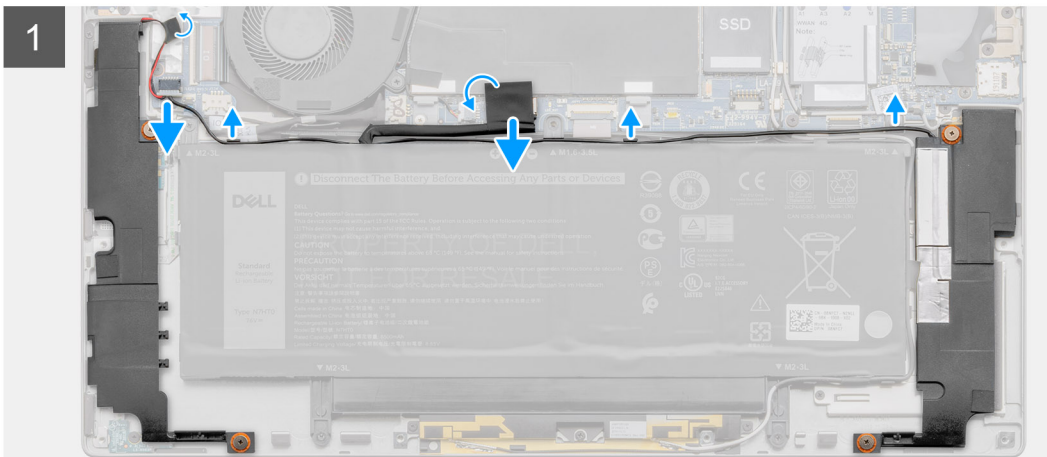
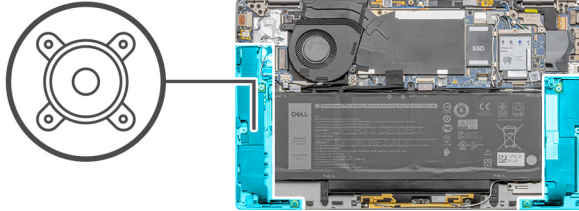

Steps

1. Peel off the adhesive tape and disconnect the battery cable from the system board.
2. Disconnect the speaker cable, and unrout the speaker cable from the routing guide.
3. Remove the four (M1.6x1.8) screws that secure the speakers, and remove the speakers from the system.

Installing the speaker

Prerequisites

If you are replacing a component, remove the existing component before performing the installation procedure.

About this task

The following image indicates the location of the speaker and provides a visual representation of the installation procedure.

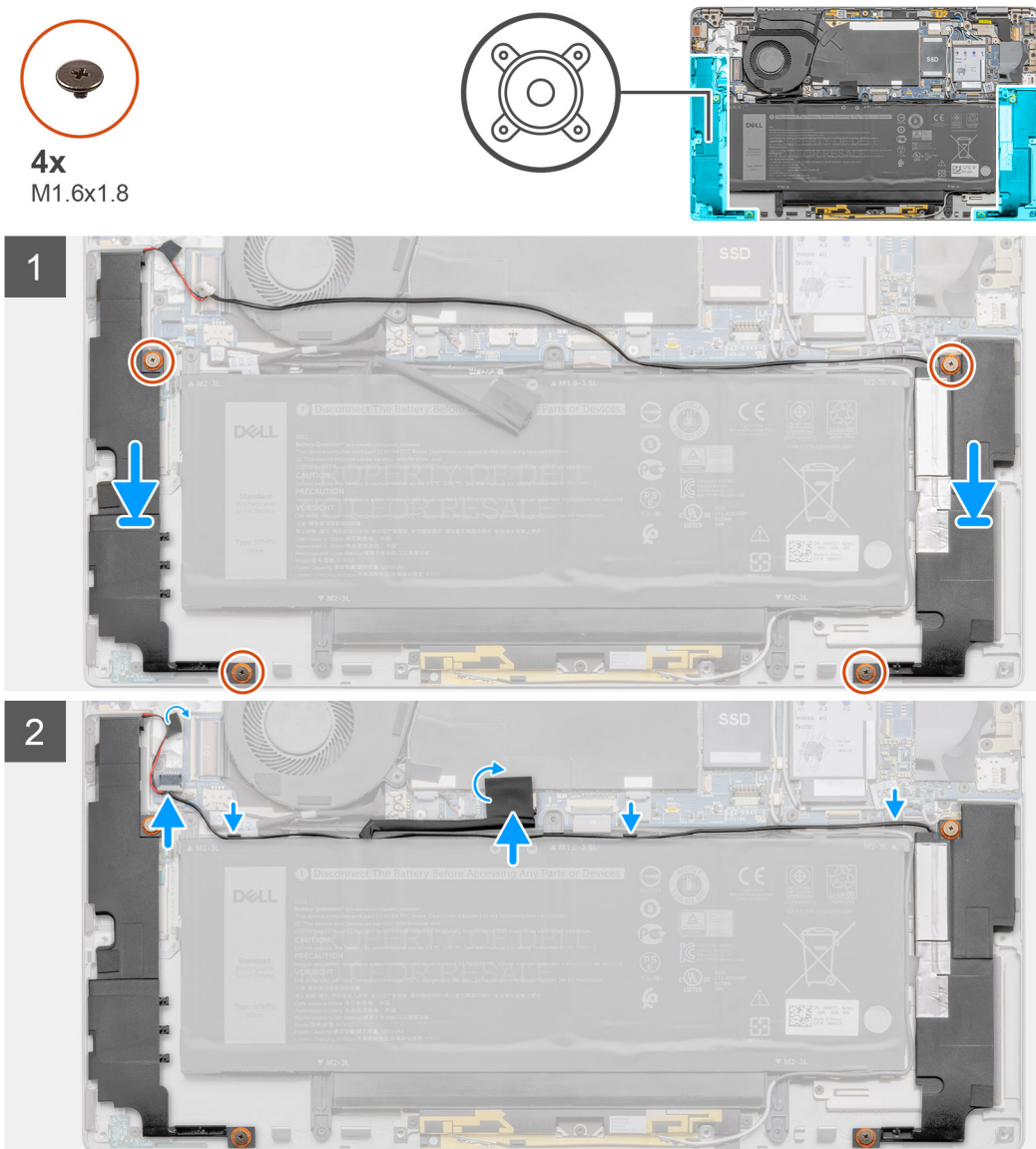

Steps

1. Align and place the speakers in the slot on the system.
2. Replace the four (M1.6x1.8) screws that secure the speakers to the system.
3. Route the speaker cables through the routing guide and connect the speaker cable to the connector.
4. Adhere the adhesive tape and reconnect the battery cable to the connector on the system board.

Next steps

1. Install the [base cover](#).
2. Install the [SIM card tray](#).
3. Install the [microSD card](#).
4. Follow the procedure in [After working on your computer](#).

System fan

Removing the system fan

Prerequisites

1. Follow the procedure in [before working inside your computer](#).
2. Remove the [microSD card](#).
3. Remove the [SIM card tray](#).
4. Enter [service mode](#).
5. Remove the [base cover](#).

About this task

The following images indicate the location of the system fan and provide a visual representation of the removal procedure.

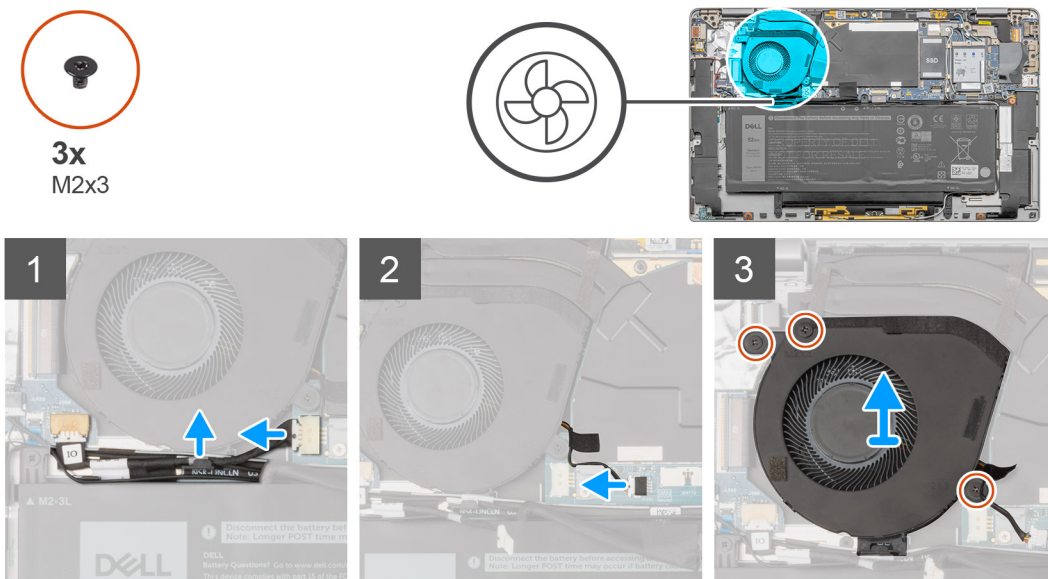

Steps

1. Disconnect the I/O daughter board cable from the connector on the system board.
2. Unroute the I/O daughter board cable from the routing guide on the system fan.
3. Disconnect the system fan cable from the connector on the system board.
4. Remove the three (M2x3) screws that secure the system fan.
5. Lift the system fan off the palmrest assembly.

Installing the system fan

Prerequisites

If you are replacing a component, remove the existing component before performing the installation procedure.

About this task

The following image indicates the location of the system fan and provides a visual representation of the installation procedure.



3x
M2x3

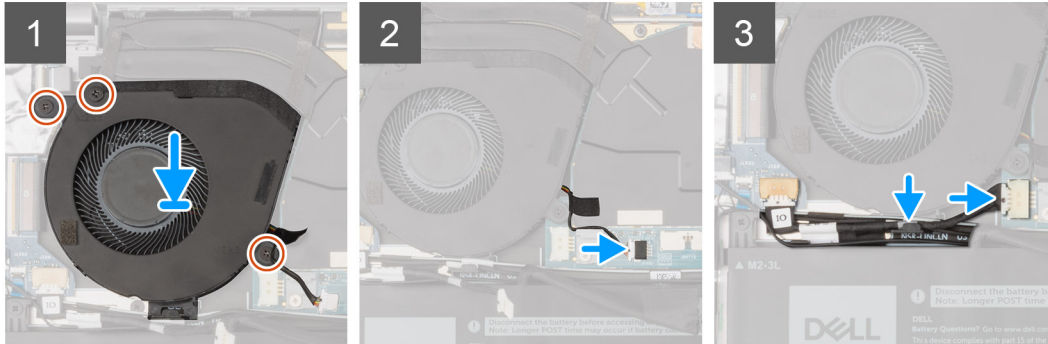
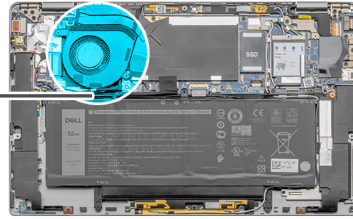
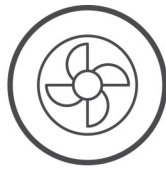

Steps

1. Align and place the system fan onto the palmrest assembly.
2. Replace the three (M2x3) screws that secure the system fan in place.
3. Connect the system fan cable to the connector on the system board.
4. Route the I/O daughter board cable through the routing guides on the system fan.
5. Connect the I/O board cable to the connector on the system board.

Next steps

1. Install the [speakers](#).
2. Install the [base cover](#).
3. Install the [SIM card tray](#).
4. Install the [microSD card](#).
5. Follow the procedure in [After working on your computer](#).

I/O daughter board power cable

Removing the I/O daughter board cable

Prerequisites

1. Follow the procedure in [before working inside your computer](#).
2. Remove the [microSD card](#).
3. Remove the [SIM card tray](#).
4. Enter [service mode](#).
5. Remove the [base cover](#).

About this task

The following images indicate the location of the I/O daughter board power cable and provide a visual representation of the removal procedure.

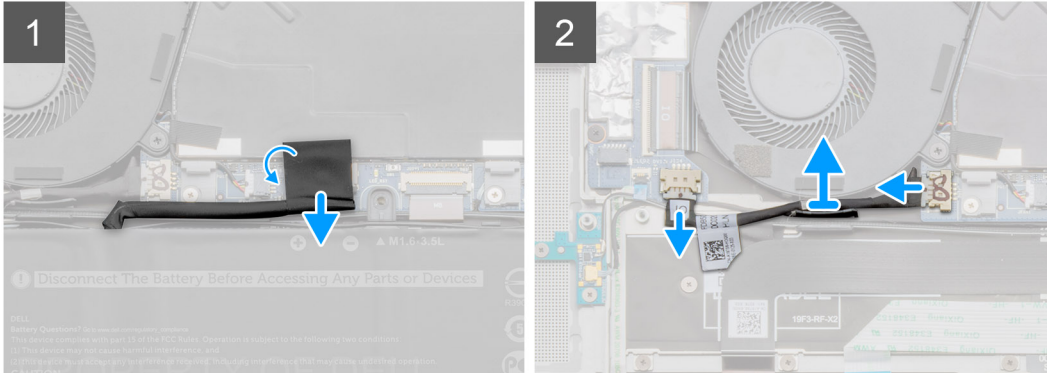
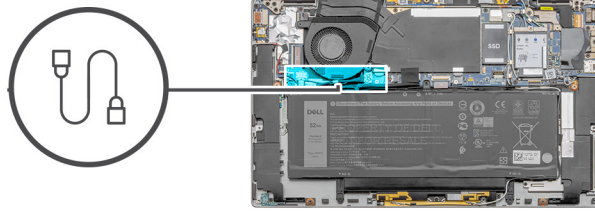

Steps

1. Disconnect the battery cable from the connector on the system board.
2. Disconnect the I/O daughter board cable from the I/O board, and system board.
3. Unroute the I/O daughter board cable from the routing channels on to the system fan.
4. Remove the I/O daughter board cable from the system.

Installing the I/O daughter board cable

Prerequisites

If you are replacing a component, remove the existing component before performing the installation procedure.

About this task

The following image indicates the location of the I/O daughter board cable and provides a visual representation of the installation procedure.

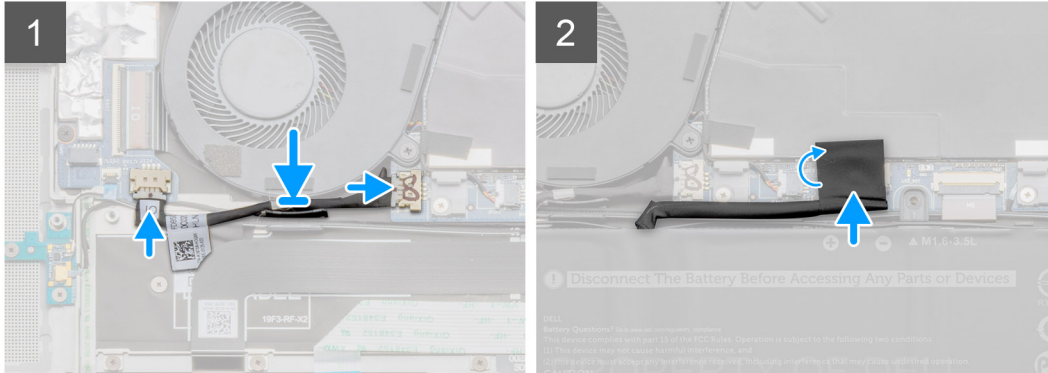
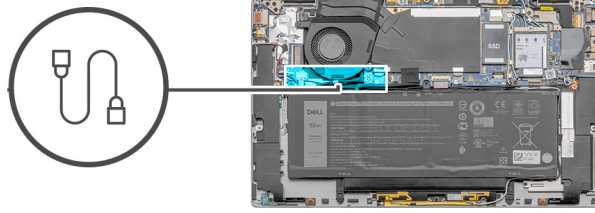

Steps

1. Route the I/O daughter board cable on the routing channels on to the system fan.
2. Connect the I/O daughter board cable to the I/O daughter board, and system board.
3. Reconnect the battery cable to the connector on the system board.

Next steps

1. Install the [base cover](#).
2. Install the [SIM card tray](#).
3. Install the [microSD card](#).
4. Follow the procedure in [After working on your computer](#) .

I/O daughter board

Removing the I/O daughter board

Prerequisites

1. Follow the procedure in [before working inside your computer](#).
2. Remove the [microSD card](#).
3. Remove the [SIM card tray](#).
4. Enter [service mode](#).
5. Remove the [base cover](#).
6. Remove the [system fan](#).
7. Remove the [I/O daughter board](#).

About this task

The following image indicates the location of the I/O board and provides a visual representation of the removal procedure.



4x
M1.6x3.5

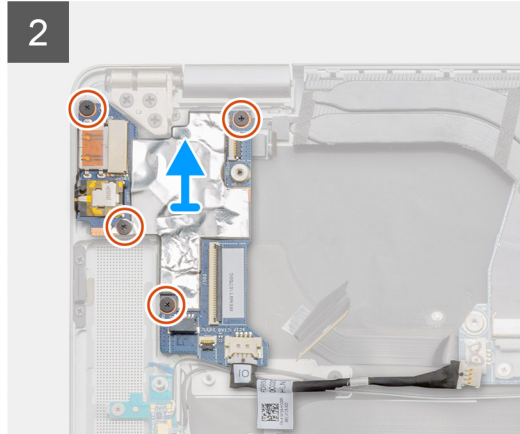
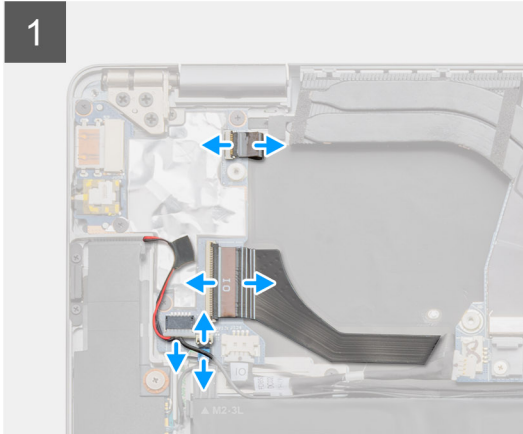
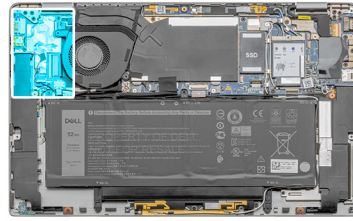

Steps

1. Disconnect the I/O daughter board data cable, fingerprint reader cable, and LED board cable from the I/O board.
2. Remove the four (M1.6x3.5) screws and lift the I/O daughter board out of the system.

Installing the I/O board

Prerequisites

If you are replacing a component, remove the existing component before performing the installation procedure.

About this task

The following image indicates the location of the I/O board and provides a visual representation of the installation procedure.



4x
M1.6x3.5

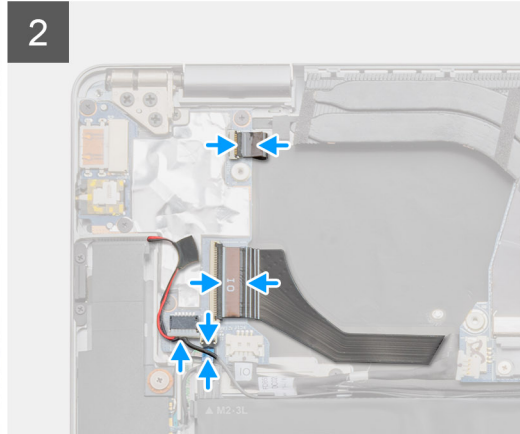
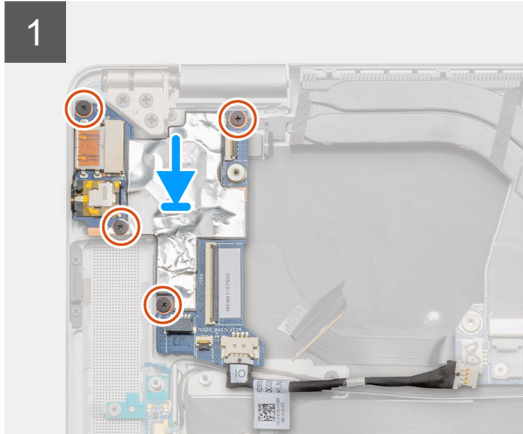
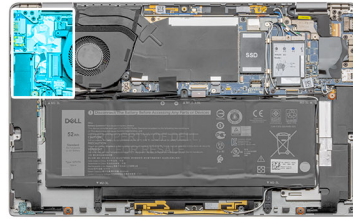

Steps

1. Align and place the I/O board on the system.
2. Replace the four (M1.6x3.5) screws to secure the I/O daughter board in place.
3. Connect the LED board cable, fingerprint reader cable, and I/O daughter board data cable to the connectors on the I/O board.

Next steps

1. Install the [I/O daughter board cable](#).
2. Install the [system fan](#).
3. Install the [base cover](#).
4. Install the [SIM card tray](#).
5. Install the [microSD card](#).
6. Follow the procedure in [After working on your computer](#).

Power button

Removing the power button

Prerequisites

1. Follow the procedure in [before working inside your computer](#).
2. Remove the [microSD card](#).
3. Remove the [SIM card tray](#).
4. Enter [service mode](#).
5. Remove the [base cover](#).
6. Remove the [system fan](#).
7. Remove the [I/O daughter board](#).

About this task

The following images indicate the location of the power-button and provide a visual representation of the removal procedure.

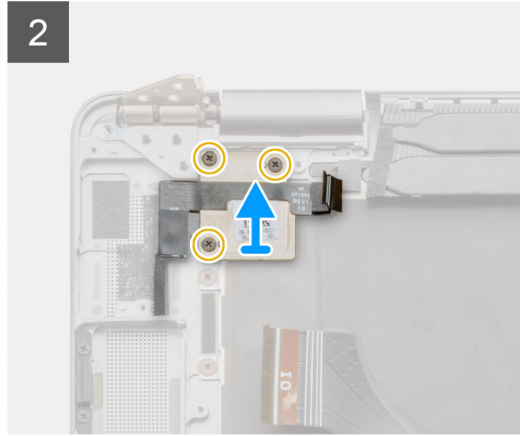
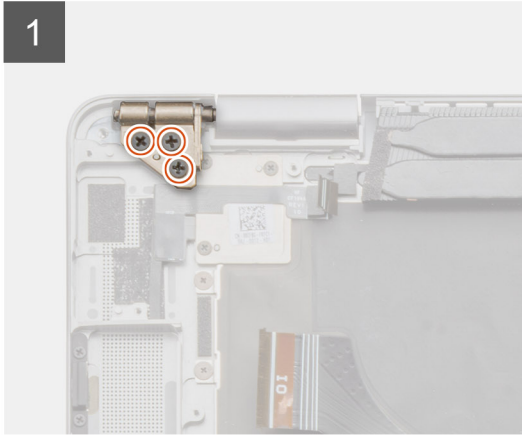
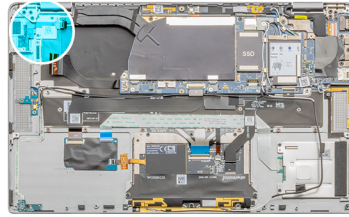

Steps

1. Remove the three (M2.5x5) screws that secures the display hinge to the chassis and fold the hinge up.
2. Remove the three (M1.5x2.5) screws from the power button bracket and remove the bracket from the system.
3. Peel off the power button assembly from the palm rest and remove the power button assembly from the system.

Installing the power button

Prerequisites

If you are replacing a component, remove the existing component before performing the installation procedure.

About this task

The following image indicate the location of the power button and provide a visual representation of the installation procedure.

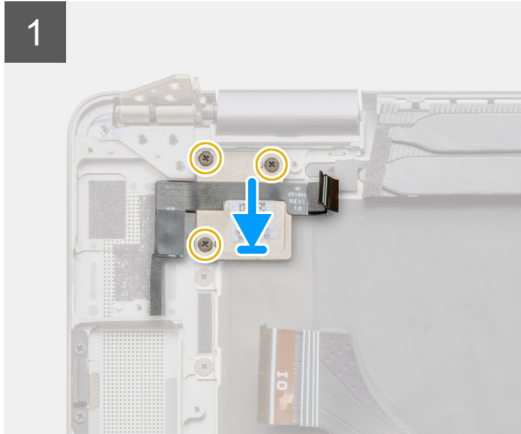
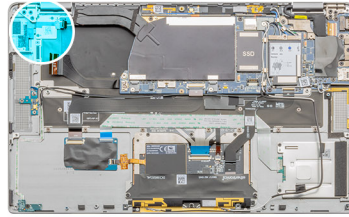

Steps

1. Align and place the power button assembly on the system. Adhere the power button assembly on the palmrest.
2. Place the power button bracket on the power button assembly and install the three (M1.5x2.5) screws.
3. Fold back the display hinge and install the three (M2.5x5) screws to secure it.

Next steps

1. Install the [I/O daughter board](#).
2. Install the [system fan](#).
3. Install the [base cover](#).
4. Install the [SIM card tray](#).
5. Install the [microSD card](#).
6. Follow the procedure in [After working on your computer](#).

Power button with finger print reader (optional)

Removing the power button with fingerprint reader

Prerequisites

1. Follow the procedure in [before working inside your computer](#).
2. Remove the [microSD card](#).
3. Remove the [SIM card tray](#).
4. Enter [service mode](#).
5. Remove the [base cover](#).
6. Remove the [system fan](#).
7. Remove the [I/O daughter board](#).

About this task

The following images indicate the location of the fingerprint reader and provide a visual representation of the removal procedure.

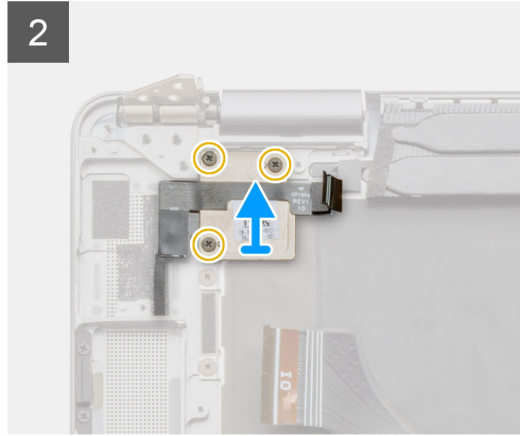
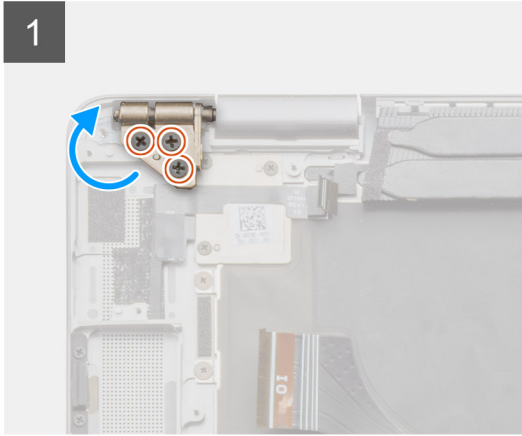

Steps

1. Remove the three (M2.5x5) screws that secures the display hinge to the chassis and fold the hinge up.
2. Remove the three (M1.5x2.5) screws from the power button bracket and remove the bracket from the system.
3. Peel off the power button with fingerprint reader assembly from the palm rest and remove it from the system.

Installing the power button with fingerprint reader

Prerequisites

If you are replacing a component, remove the existing component before performing the installation procedure.

About this task

The following images indicate the location of the fingerprint reader and provide a visual representation of the installation procedure.

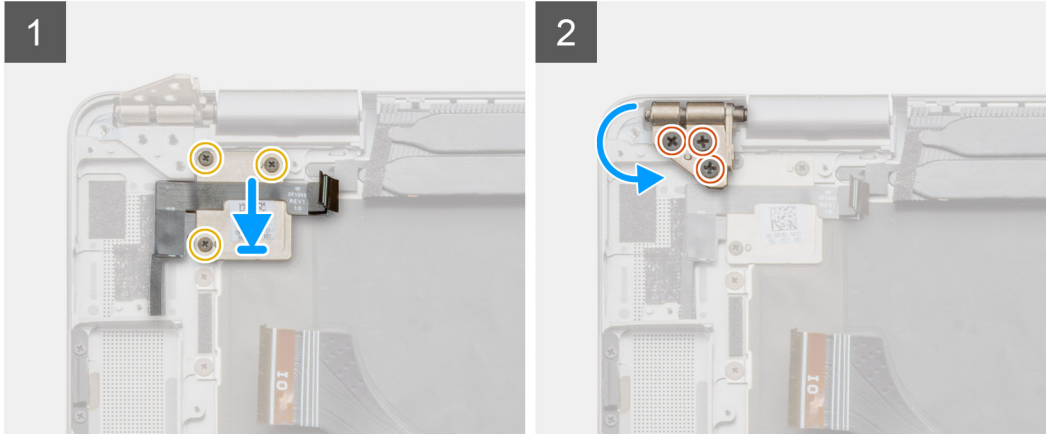

Steps

1. Align and place the power button with fingerprint reader assembly on the system and adhere it to the palmrest.
2. Align and place the power button with fingerprint reader bracket in place, and install the three (M1.5x2.5) screws.
3. Fold back the display hinge and install the three (M2.5x5) screws to secure it.

Next steps

1. Install the [I/O daughter board](#).
2. Install the [system fan](#).
3. Install the [base cover](#).
4. Install the [SIM card tray](#)
5. Install the [microSD card](#).
6. Follow the procedure in [After working on your computer](#).

Battery

Lithium-ion battery precautions

⚠ CAUTION:

- Exercise caution when handling Lithium-ion batteries.
- Discharge the battery completely before removing it. Disconnect the AC power adapter from the system and operate the computer solely on battery power—the battery is fully discharged when the computer no longer turns on when the power button is pressed.
- Do not crush, drop, mutilate, or penetrate the battery with foreign objects.
- Do not expose the battery to high temperatures, or disassemble battery packs and cells.
- Do not apply pressure to the surface of the battery.
- Do not bend the battery.
- Do not use tools of any kind to pry on or against the battery.
- Ensure any screws during the servicing of this product are not lost or misplaced, to prevent accidental puncture or damage to the battery and other system components.

- If the battery gets stuck inside your computer as a result of swelling, do not try to release it as puncturing, bending, or crushing a lithium-ion battery can be dangerous. In such an instance, contact Dell technical support for assistance. See www.dell.com/contactdell.
- Always purchase genuine batteries from www.dell.com or authorized Dell partners and resellers.
- Swollen batteries should not be used and should be replaced and disposed properly. For guidelines on how to handle and replace swollen Lithium-ion batteries, see [Handling swollen Lithium-ion batteries](#).

Removing the 4-cell battery

Prerequisites

1. Follow the procedure in [before working inside your computer](#).
2. Remove the [microSD card](#).
3. Remove the [SIM card tray](#).
4. Remove the [base cover](#).

NOTE: If battery was disconnected from system board for service, there will be a delay during system boot-up as the system will undergo RTC battery reset.

About this task

The following images indicate the location of the battery and provide a visual representation of the removal procedure.

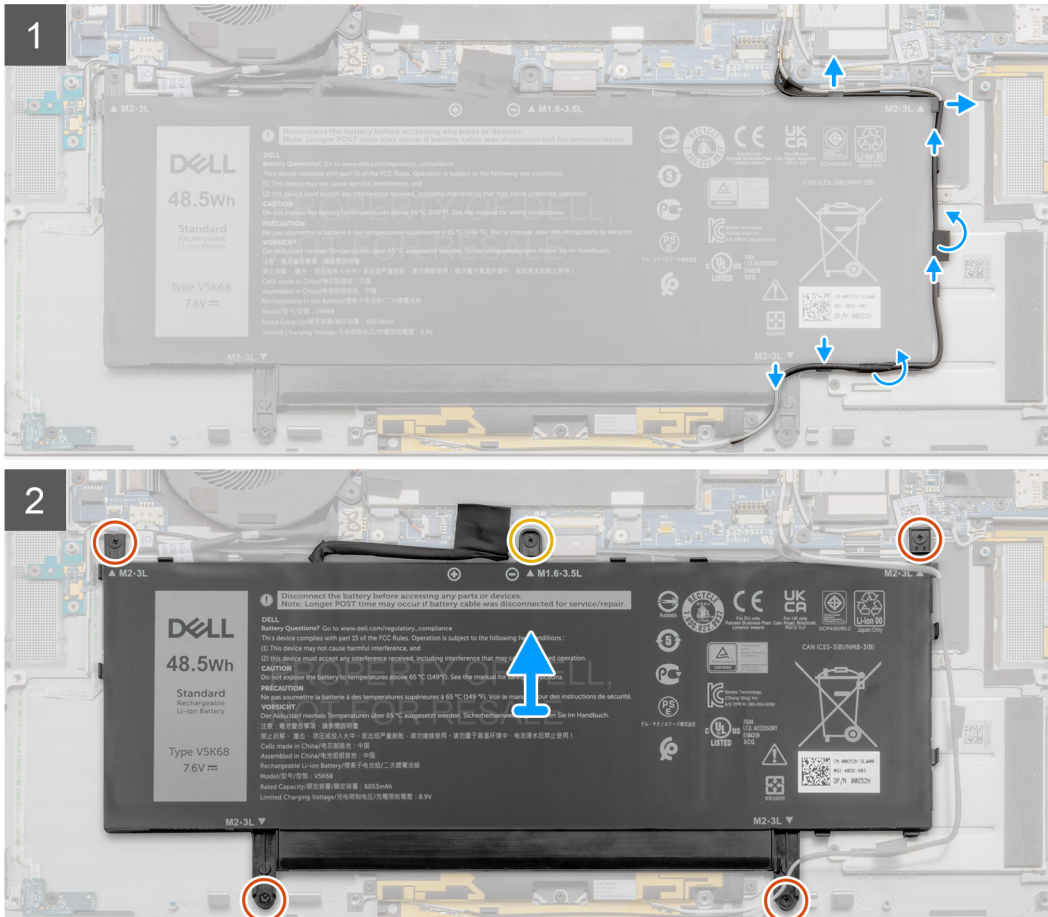
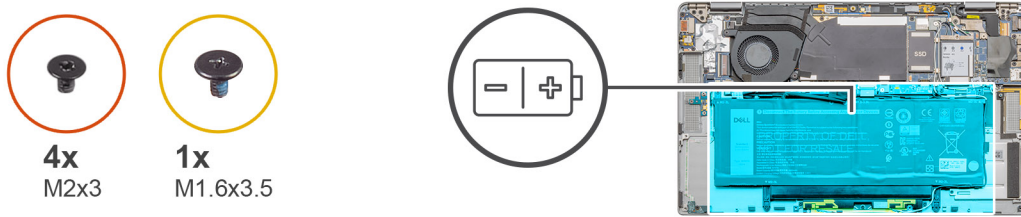

Steps

1. Peel off the adhesive tape that secures the wireless antenna cables in place and unroute the wireless antenna cables from the routing guides.

NOTE: The cables for the wireless antennas are routed over the plastic bracket at the upper right corner and within the routing channels along the bottom right side of the battery. Users must be careful when unrouting the antenna cables from their routing guides while they are still attached to the wireless card.
2. Disconnect the battery cable from the connector on the system board.
3. Remove the single (M1.6x3.5) screw and four (M2x3) screws that secures the battery.
4. Lift the battery from the left side of the system, and remove the battery from the system.

Installing the 4-cell battery

Prerequisites

If you are replacing a component, remove the existing component before performing the installation procedure.

About this task

The following image indicates the location of the battery and provides a visual representation of the installation procedure.

NOTE: If battery was disconnected from system board for service, there will be a delay during system boot-up as the system will undergo RTC battery reset.

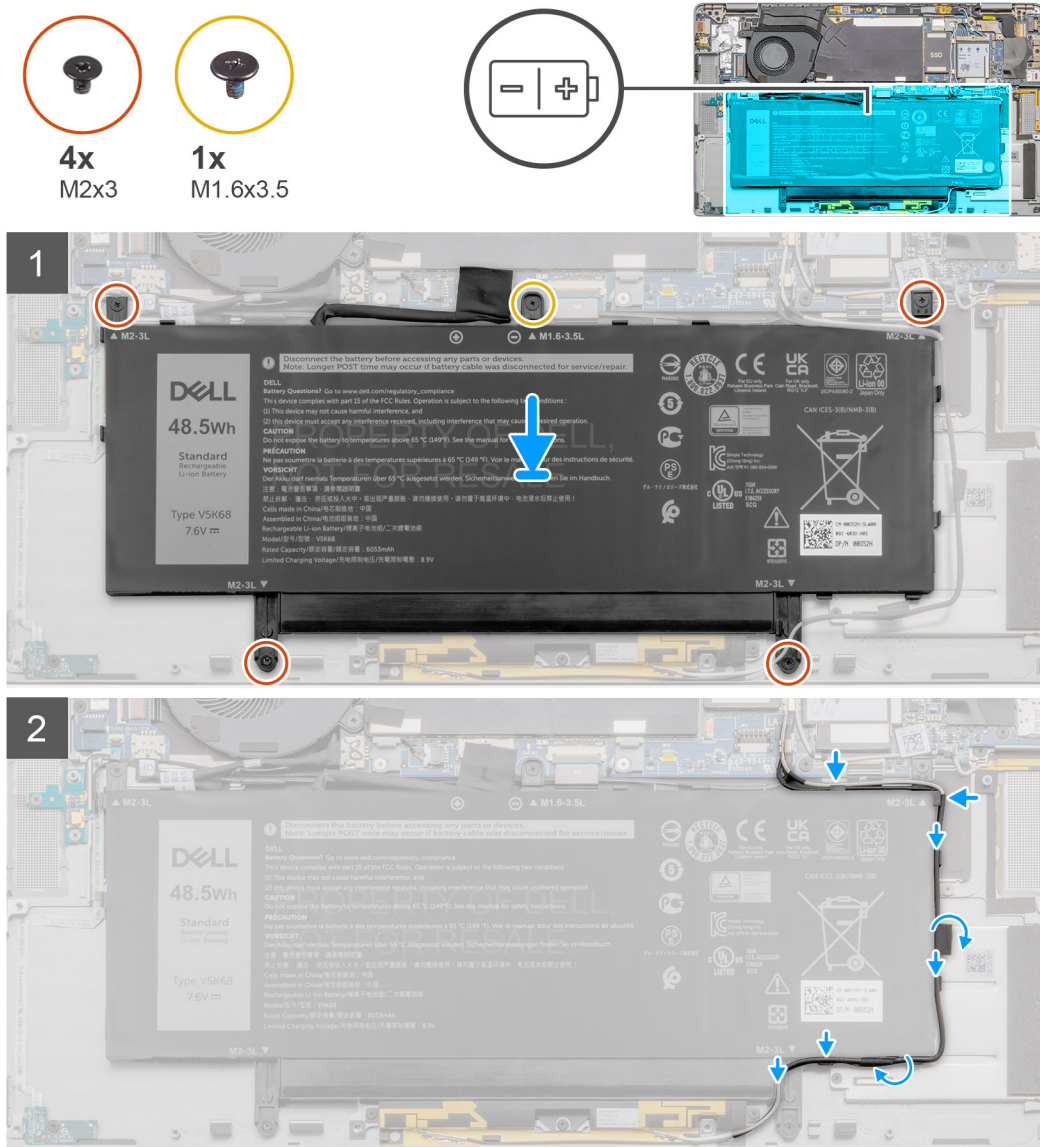

Steps

1. Align and place the battery on the palmrest and keyboard assembly.
2. Replace the single (M1.6x3.5) screw and four (M2x3) screws to secure the battery in place.
3. Reconnect the battery cable to the connector on the system board.
4. Route the wireless antenna cables on the routing guides and adhere the adhesive tape.

Next steps

1. Install the [speakers](#).
2. Install the [base cover](#).
3. Install the [SIM card tray](#).
4. Install the [microSD card](#).
5. Follow the procedure in [After working on your computer](#).

Removing the 6-cell battery

Prerequisites

1. Follow the procedure in [before working inside your computer](#).
2. Remove the [microSD card](#).
3. Remove the [SIM card tray](#).
4. Remove the [base cover](#).
5. Remove the [speakers](#).

About this task

The following images indicate the location of the battery and provide a visual representation of the removal procedure.

NOTE: If battery was disconnected from system board for service, there will be a delay during system boot-up as the system will undergo RTC battery reset.

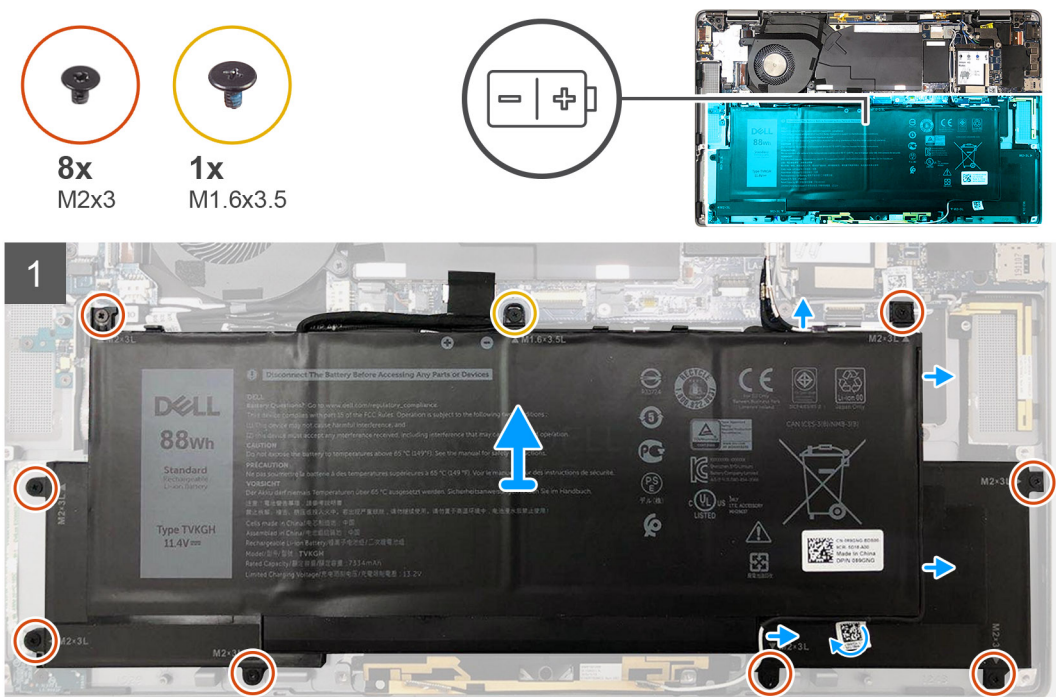

Steps

1. Peel off the adhesive tape securing the wireless antenna cables in place and unroute the wireless antenna cables from the routing guides.
NOTE: The cables for the wireless antennas are routed over the plastic bracket at the upper right corner and within the routing channels along the bottom left side of the battery. Users must be careful when unrouting the antenna cables from their routing guides while they are still attached to the wireless card.
2. Disconnect the battery cable from the connector on the system board.
3. Remove the single (M1.6x3.5) and eight (M2x3) screws that secures the battery.
4. Lift the battery from the left side and remove the battery from the laptop.

Installing the 6-cell battery

About this task

The following image indicates the location of the battery and provides a visual representation of the installation procedure.

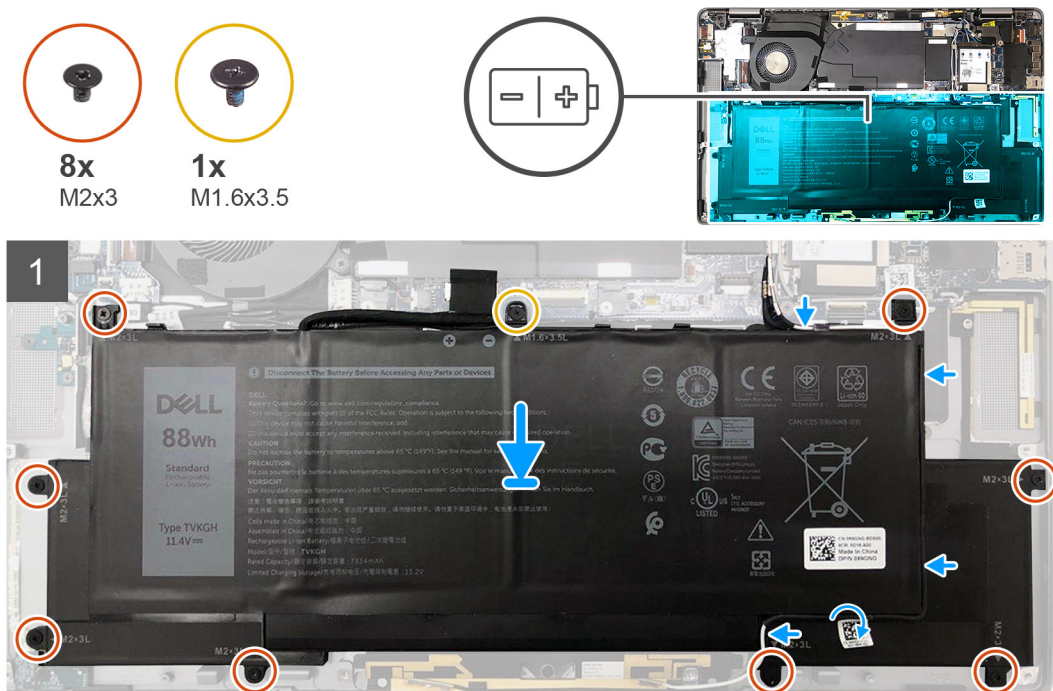

NOTE: If battery was disconnected from system board for service, there will be a delay during system boot-up as the system will undergo RTC battery reset.

Steps

1. Align and place the battery on the palmrest and keyboard assembly.
2. Install the single (M1.6x3.5) and eight (M2x3) screws to secure the battery in place.
3. Reconnect the battery cable to the connector on the system board.
4. Route the wireless antenna cables on the routing guides and adhere the adhesive tape.

Next steps

1. Install the [speakers](#).
2. Install the [base cover](#).
3. Install the [SIM card tray](#).
4. Install the [microSD card](#).
5. Follow the procedure in [After working on your computer](#).

Smart card reader

Removing the smart card reader

Prerequisites

1. Follow the procedure in [before working inside your computer](#).
2. Remove the [microSD card](#).
3. Remove the [SIM card tray](#).
4. Remove the [base cover](#).
5. Remove the [battery](#).
6. Remove the [speakers](#).

About this task



2x
M2x2

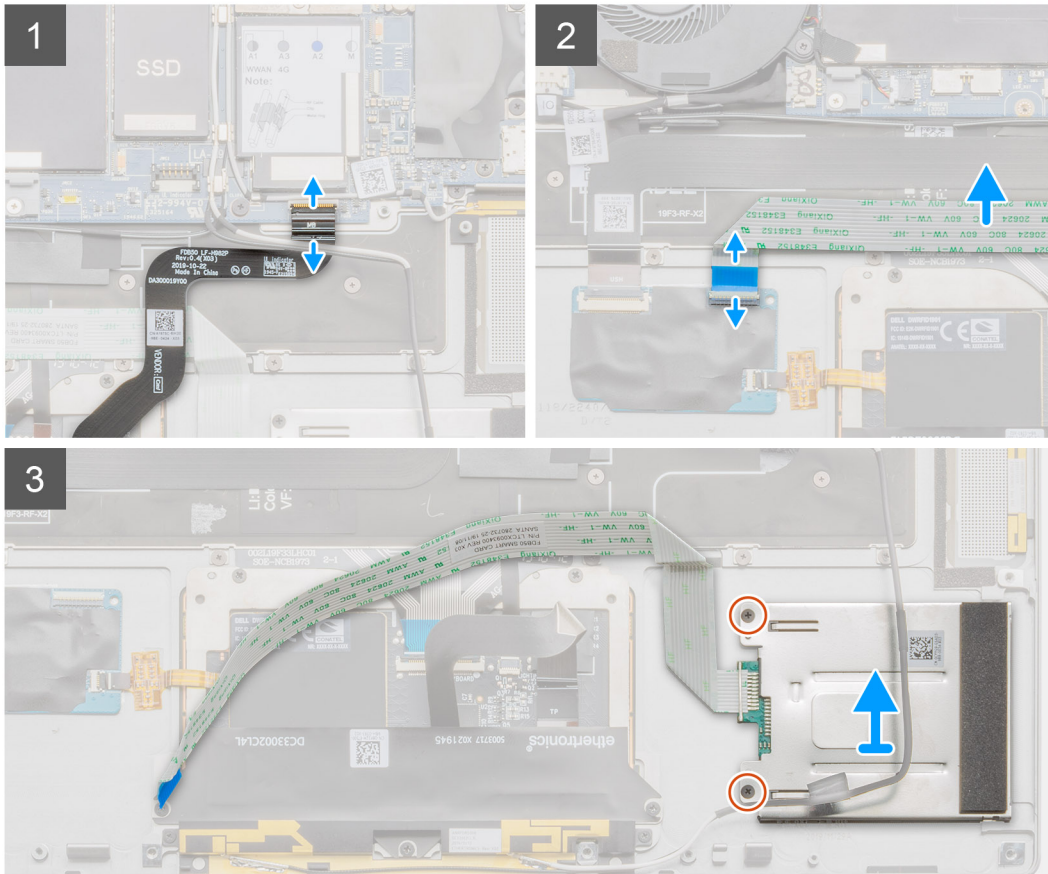
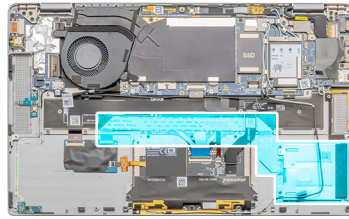

Steps

1. Open the latch and disconnect the touchpad FPC from the system board.
2. Open the latch and disconnect the smart card reader cable from the I/O-daughter board.
3. Remove the two screws (M2x2) that secure the smart card reader to the palmrest assembly.
4. Lift the smart card reader away from the palmrest assembly.

Installing the smart card reader

Prerequisites

If you are replacing a component, remove the existing component before performing the installation procedure.

About this task



2x
M2x2

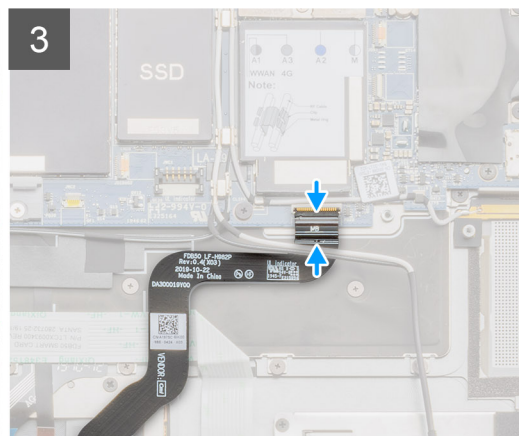
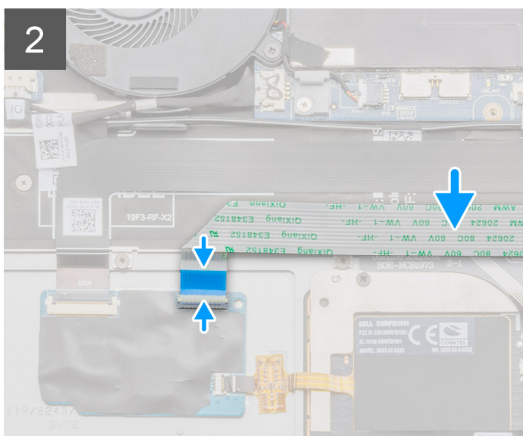
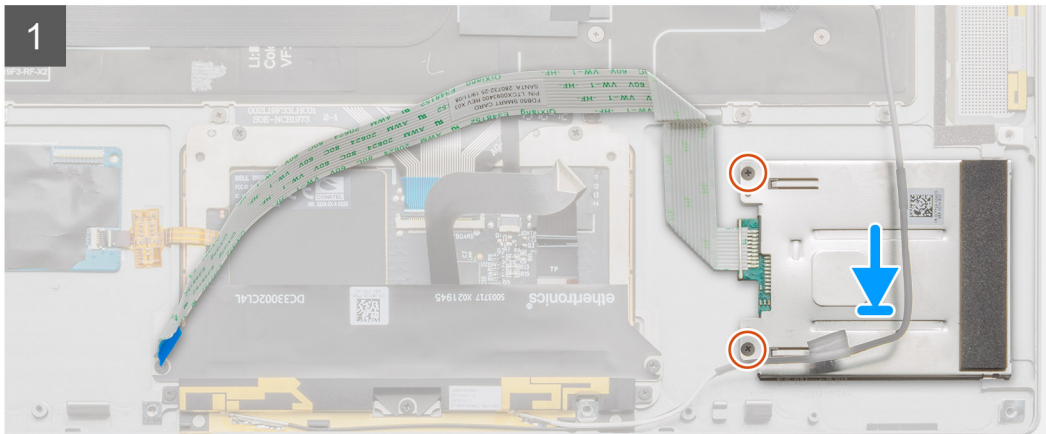
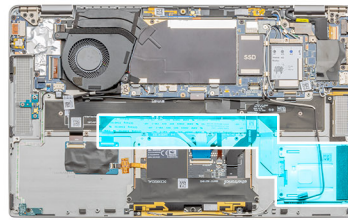

Steps

1. Align and place the smart card reader on the palmrest assembly.
2. Replace the two screws (M2x2) to secure the smart card reader to the palmrest assembly.
3. Connect the smart card reader cable to the connector on the I/O-daughter board and close the latch.
4. Connect the touchpad FPC to the connector on the system board and close the latch.

Next steps

1. Install the [battery](#).
2. Install the [speakers](#).
3. Install the [base cover](#).
4. Install the [SIM card tray](#).
5. Install the [microSD card](#).
6. Follow the procedure in [After working on your computer](#).

System board

Removing the system board

Prerequisites

1. Follow the procedure in [before working inside your computer](#).
2. Remove the [microSD card](#).
3. Remove the [SIM card tray](#).
4. Remove the [base cover](#).
5. Remove the [solid-state drive](#).
6. Remove the [WWAN card](#).
7. Remove the [speakers](#).
8. Remove the [battery](#).
9. Remove the [system fan](#).

About this task

The following images indicate the location of the system board assembly and provide a visual representation of the removal procedure.

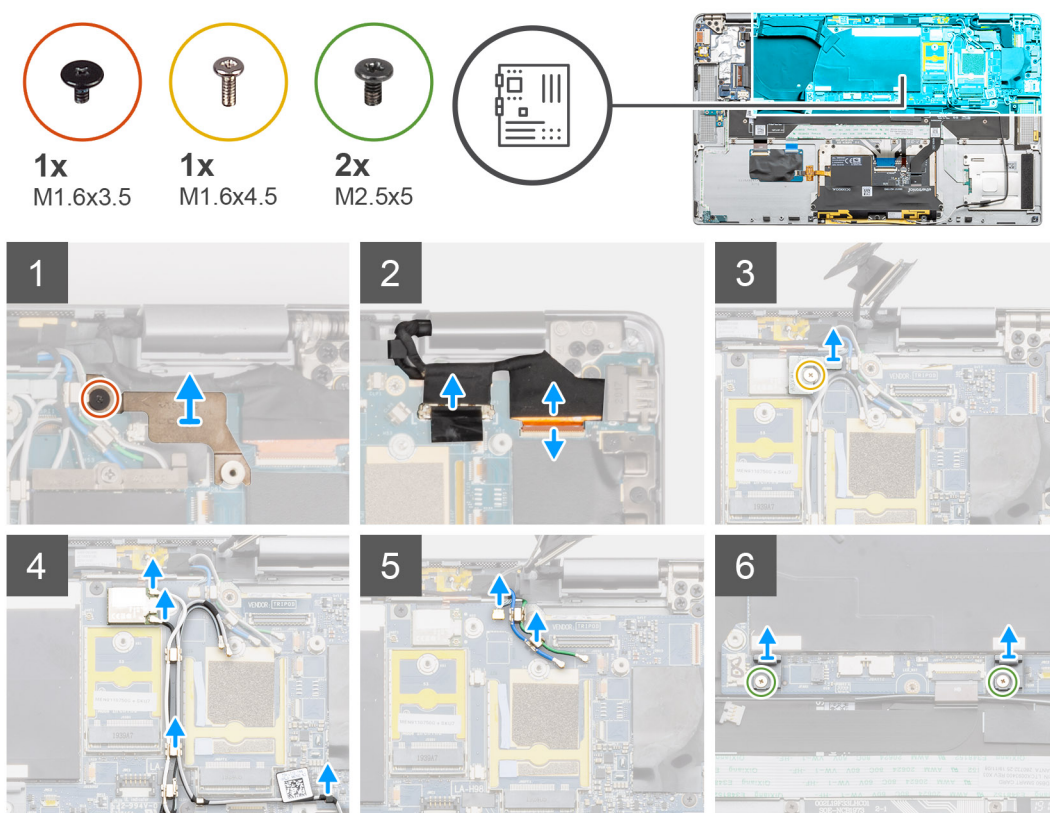



8x
M1.6x3.5

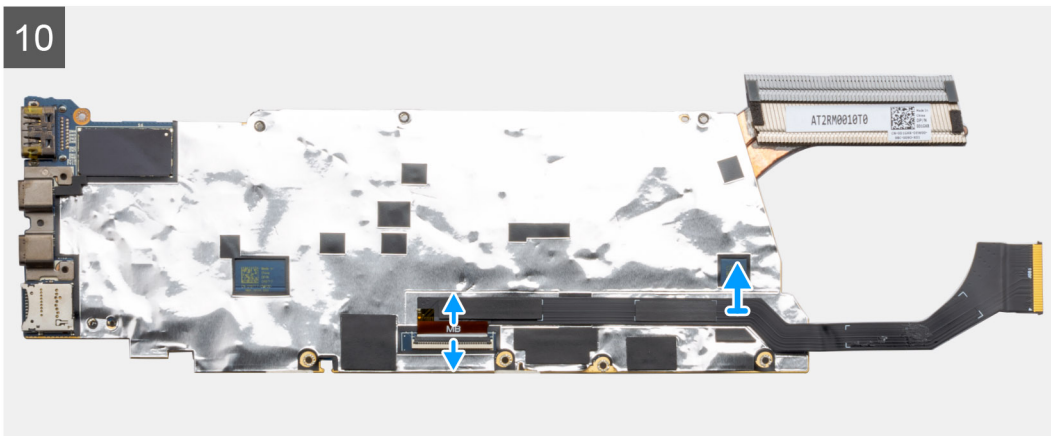
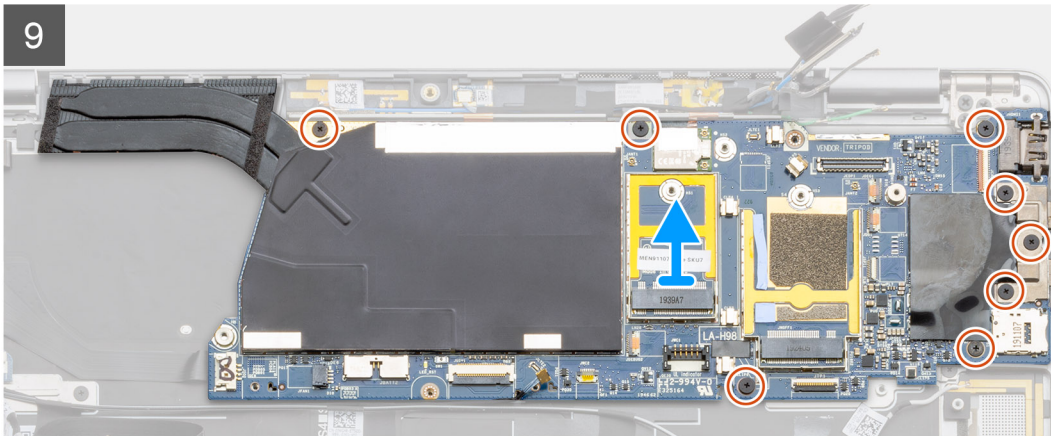
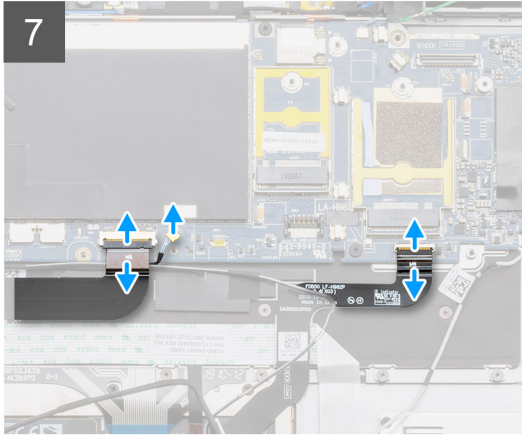

NOTE: Replacement system boards are pre-assembled with heat sink. Do not remove the heat sink from system board. The system board can be replaced together with the heat sink attached.

Steps

1. Remove the single (M1.6x3.5) screw that secures the display-cable bracket to the system board.

2. Push the display-cable bracket from the bottom edge to release the bracket from the securing peg, and remove it from the system.
3. Disconnect the display cable and camera cable from the system board.
 - NOTE:** Users must disconnect the display cable from the system board by pulling the pull tab in a direct upward motion to prevent damage to the connector.
4. Remove the single (M1.6x4.5) screw that secures the wireless module bracket to the system board.
5. Lift and remove the wireless module bracket away from the system board.
6. Use a plastic scribe and disconnect the Darwin antenna cables from the wireless module, then unroute the cables from the routing guides on the system board.
7. Disconnect and unroute the WWAN antenna cable from the routing guides on the system board.
8. Remove the two (M1.6x4.5) screws that secure the two system board hooks to the system board.
9. Disconnect the USH daughter board FFC cable, WWAN Darwin cable, and touchpad FPC from the connector on the system board.
 - NOTE:** To disconnect the WWAN Darwin cable from the system board, insert a plastic scribe close to the rear side of the connector, and carefully pry in an upward direction.
10. Disconnect the I/O daughter board data FPC cable from the I/O daughter board.
11. Remove the three (M1.6x3.5) screws that secure the USB Type-C bracket to the system board.
12. Remove the five (M1.6x3.5) screws that secure the system board to the palmrest and keyboard assembly.
13. Hold the left side of the system board and partially lift the system board from the system.
14. Flip over the system board from the top side of the system board. Disconnect the I/O daughter board data cable, and remove the system board from the system.

Installing the system board

Prerequisites

If you are replacing a component, remove the existing component before performing the installation procedure.

About this task

The following image indicates the location of the system board and provides a visual representation of the installation procedure.

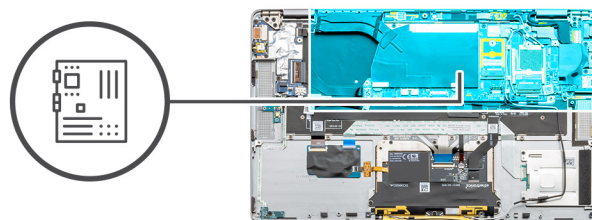



8x
M1.6x3.5

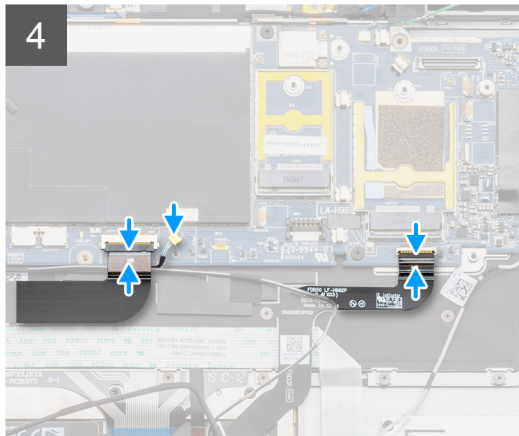
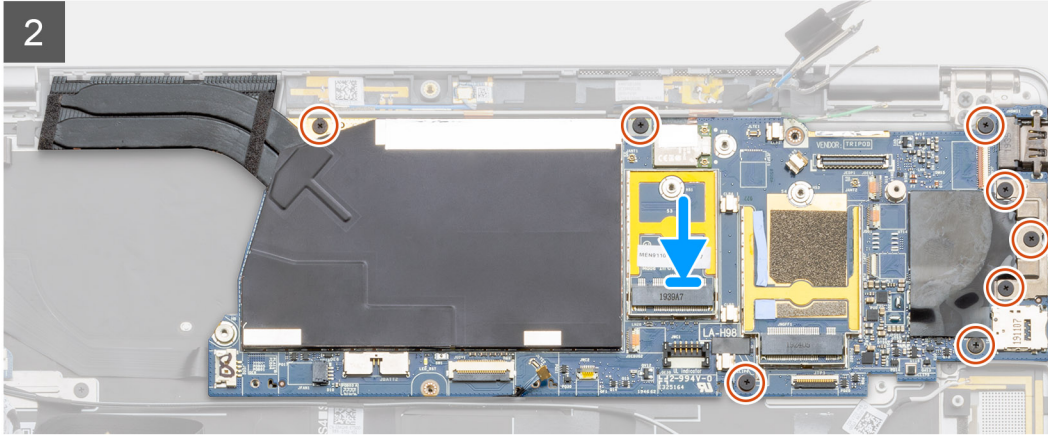

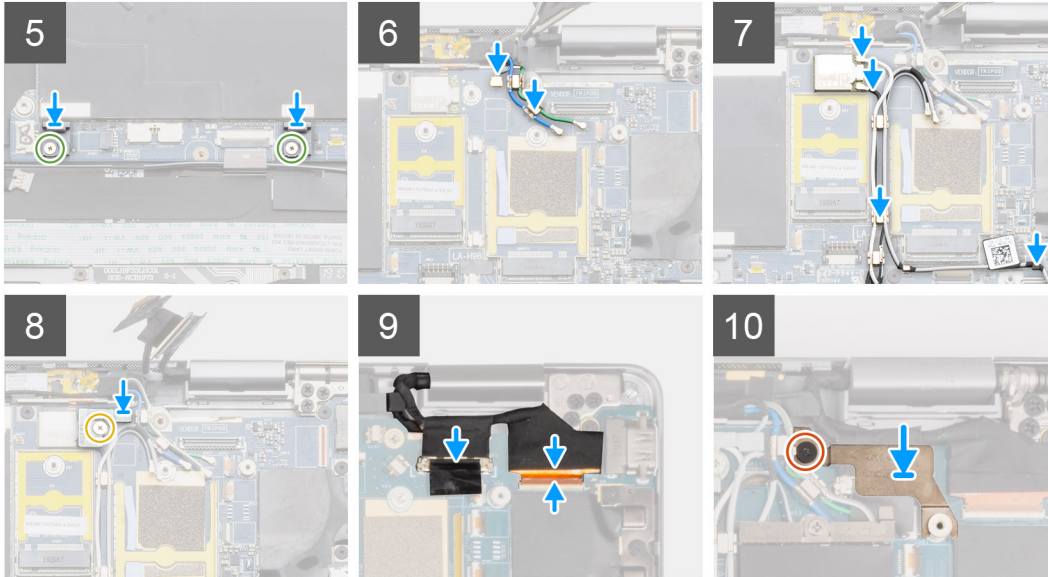
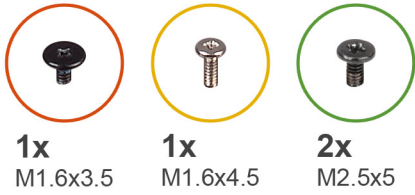

Steps

1. Flip the system board over and connect the I/O daughter board data cable.
2. Align and place the system board on the palmrest and keyboard assembly.
3. Replace the five (M1.6x3.5) screws to secure the system board to the palmrest and keyboard assembly .
4. Replace the three (M1.6x3.5) screws to secure the USB Type-C bracket to the system board.
5. Connect the I/O daughter board data FPC cable to the connector on the I/O daughter board.
6. Connect the USH daughter board FFC cable, WWAN Darwin cable, and Touchpad FPC to the connector on the system board.
7. Replace the two (M1.6x4.5) screws to secure the two system board hooks to the system board.
 - i NOTE:** Do not slide the hooks on the system board to fit the positioning studs into the openings, as this will damage the system board. When installing the hooks, align the positioning studs on the hooks over the openings on the system board and then install the hooks on the system board.
8. Route the WWAN antenna cable through the routing guides on the system board. and connect them to the WWAN card.
9. Connect the Darwin antenna cables to the wireless module, and route the cables through the routing guides on the system board.
10. Align and place the wireless module bracket on the system board.
11. Replace the single (M1.6x4.5) screw to secure the wireless module bracket to the system board.
12. Connect the display cable, and camera cable to the system board.
13. Replace the single (M1.6x3.5) screw to secure the display-cable bracket to the system board.

Next steps

1. Install the [system fan](#).
2. Install the [speakers](#).
3. Install the [battery](#).
4. Install the [solid-state drive](#).
5. Install the [WWAN card](#).

6. Install the [base cover](#).
7. Install the [SIM card tray](#).
8. Install the [microSD card](#).
9. Follow the procedure in [After working on your computer](#).

Display assembly

Removing the display assembly

Prerequisites

1. Follow the procedure in [before working inside your computer](#).
2. Remove the [microSD card](#).
3. Remove the [SIM card tray](#).
4. Remove the [base cover](#).
5. Remove the [battery](#).

About this task

The following images indicate the location of the display assembly and provide a visual representation of the removal procedure.

 **NOTE:** The display assembly removal procedure is the same for both laptop and convertible chassis.



1x
M1.6x3.5



6x
M2.5x5

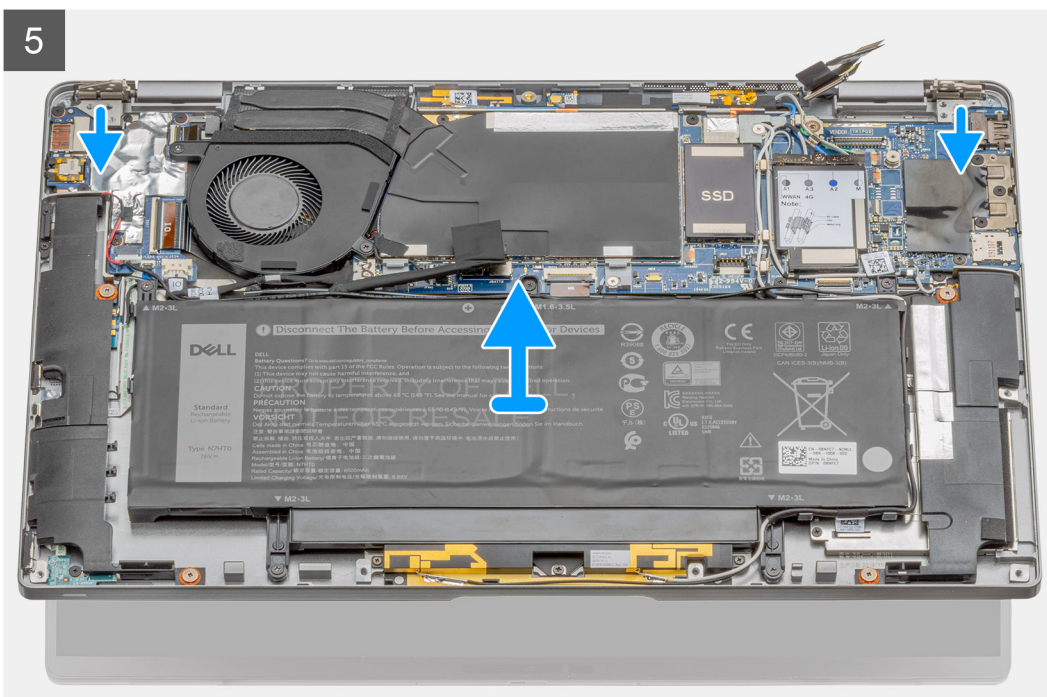
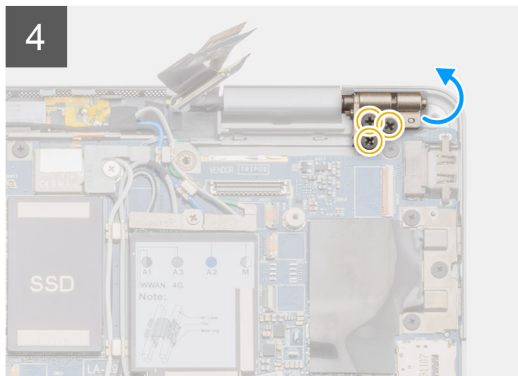
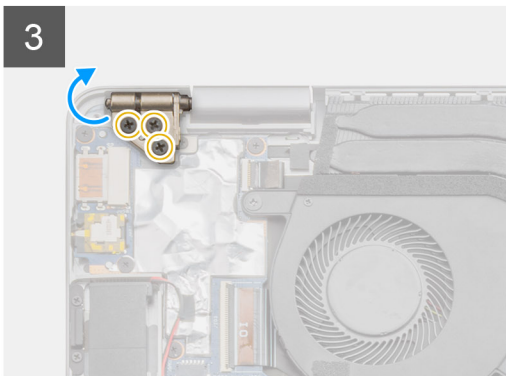
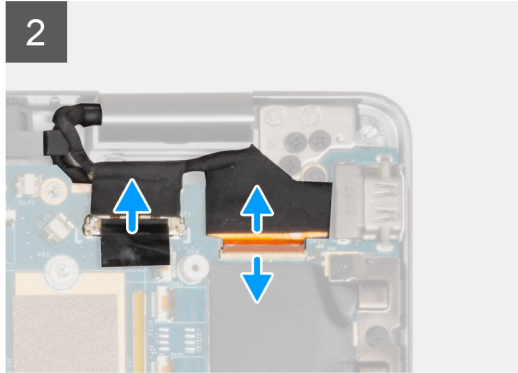
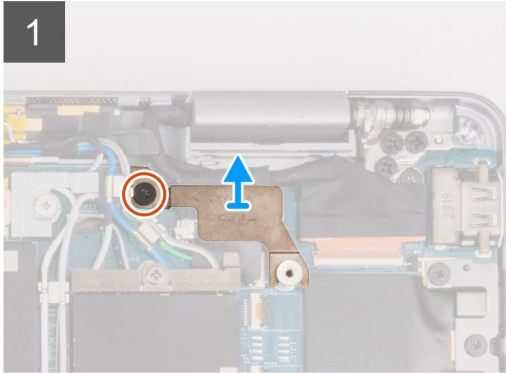
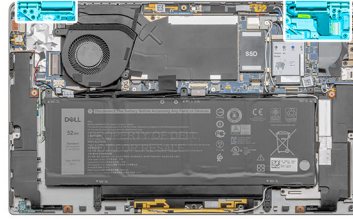

6



Steps

1. Remove the single (M1.6x3.5) screw that secures the display-cable bracket and lift the display-cable bracket.
2. Using the pull tab, disconnect the display cable from the system board and peel back the camera cable from the system board.

i **NOTE:** Users must disconnect the display cable from the system board by pulling the pull tab in a direct upward motion to prevent damage to the connector's pins.

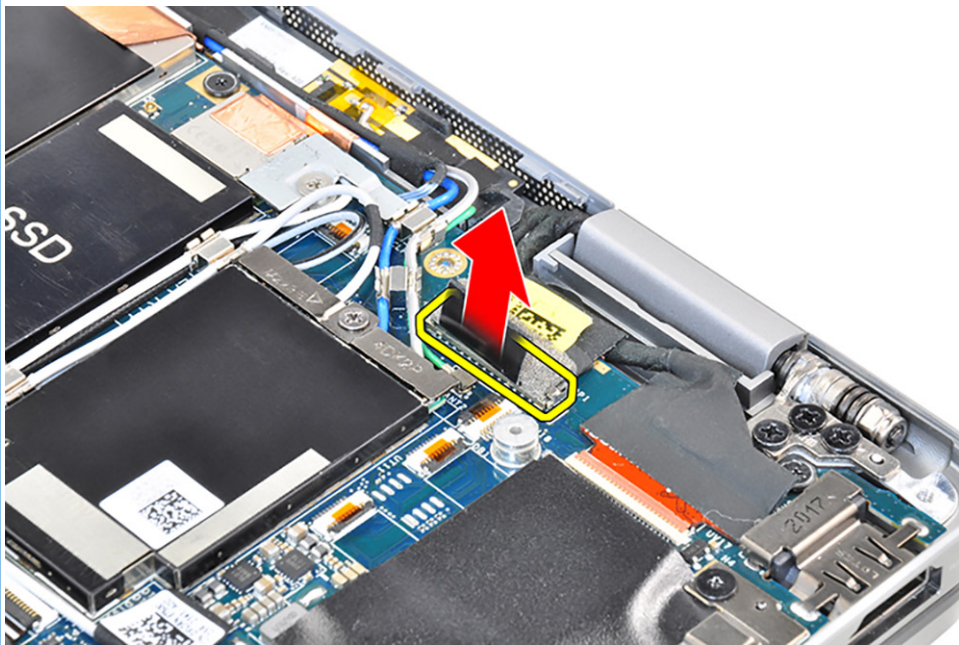

i **NOTE:** The camera cable has a tiny latch that locks the cable and secures it to the system board. Users must lift this latch to release the camera cable.

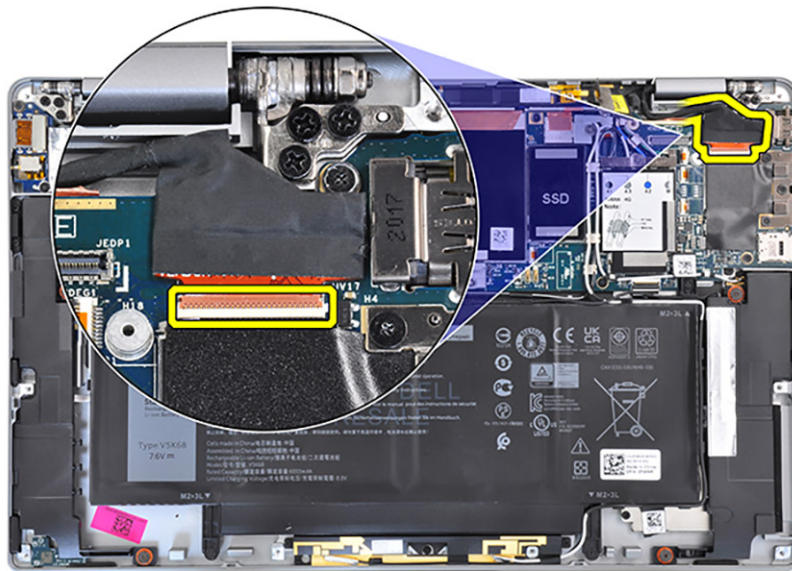

CAUTION: This latch is fragile and requires care when flipping it up to unlock the camera cable.

3. Remove the three (M2.5x5) screws from the left hinge and fold back the left hinge.

NOTE: Press the edges of the laptop near the hinges, and fold back the hinges in the upward direction away from the laptop.

4. Remove the three (M2.5x5) screws from the right hinge and fold back the right hinge.
5. Open the system chassis to 45 degrees, and slide the system from the display assembly.

Installing the display assembly

Prerequisites

If you are replacing a component, remove the existing component before performing the installation procedure.

NOTE: The display assembly installation procedure is the same for both laptop and convertible chassis.

About this task

The following image indicates the location of the display assembly and provides a visual representation of the installation procedure.

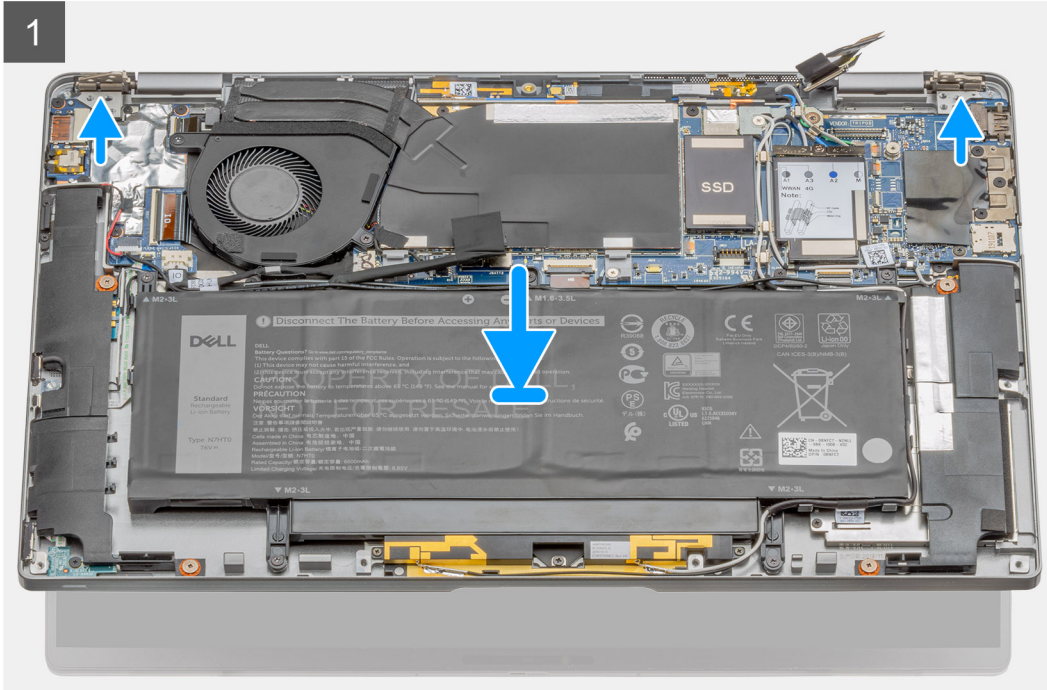
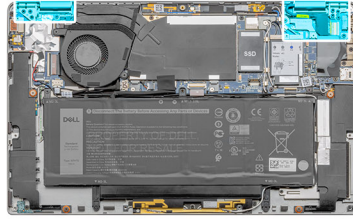



1x
M1.6x3.5

6x
M2.5x5

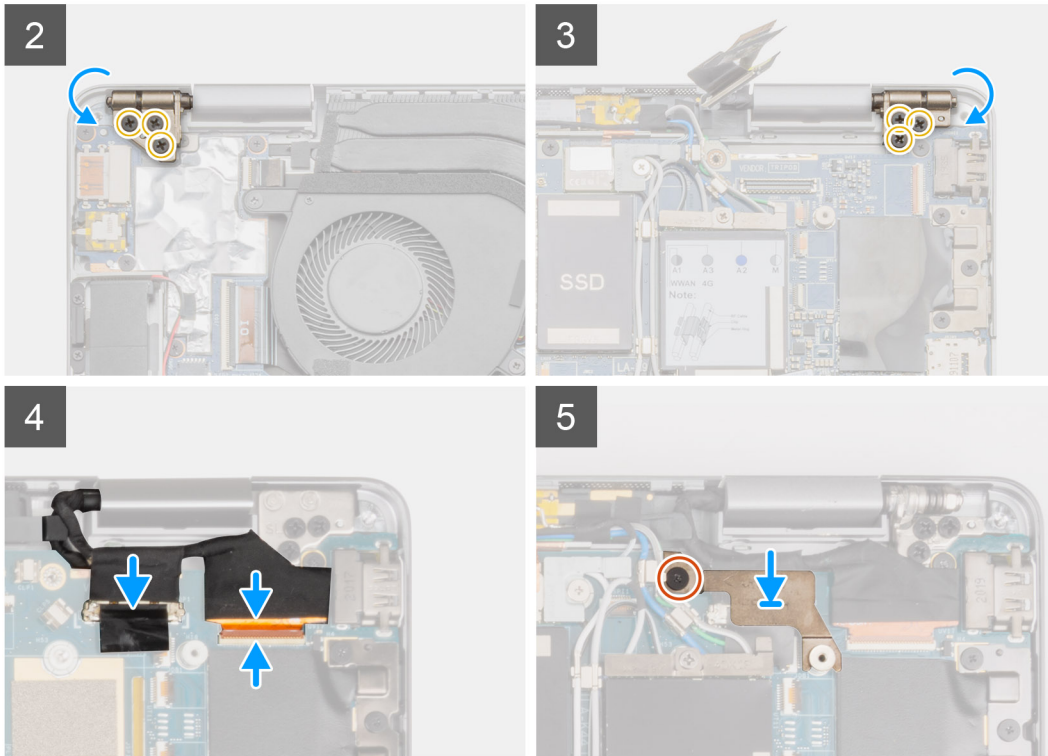

Steps

1. Align and place the system chassis under the hinges of the display assembly.
2. Install the six (M2.5x5) screws that secure the display hinges to the laptop.
3. Connect the display cable to the system board. Connect and adhere the camera cable to the system board.
4. Place the display cable bracket in place and install the single (M1.6x3.5) screw securing the display cable bracket.

Next steps

1. Install the [battery](#).
2. Install the [base cover](#).
3. Install the [SIM card tray](#).
4. Install the [microSD card](#).
5. Follow the procedure in [After working on your computer](#) .

Keyboard

Removing the keyboard

Prerequisites

1. Follow the procedure in [before working inside your computer](#).
2. Remove the [microSD card](#).

3. Remove the [SIM card tray](#).
4. Remove the [base cover](#).
5. Remove the [solid-state drive](#).
6. Remove the [WWAN card](#).
7. Remove the [speakers](#).
8. Remove the [battery](#).
9. Remove the [display assembly](#).
10. Remove the [system fan](#).
11. Remove the [I/O daughter board](#).
12. Remove the [system board](#).

About this task

The following images indicate the location of the keyboard and provide a visual representation of the removal procedure.



36x
M1.6x1.5



4x
M1.6x2

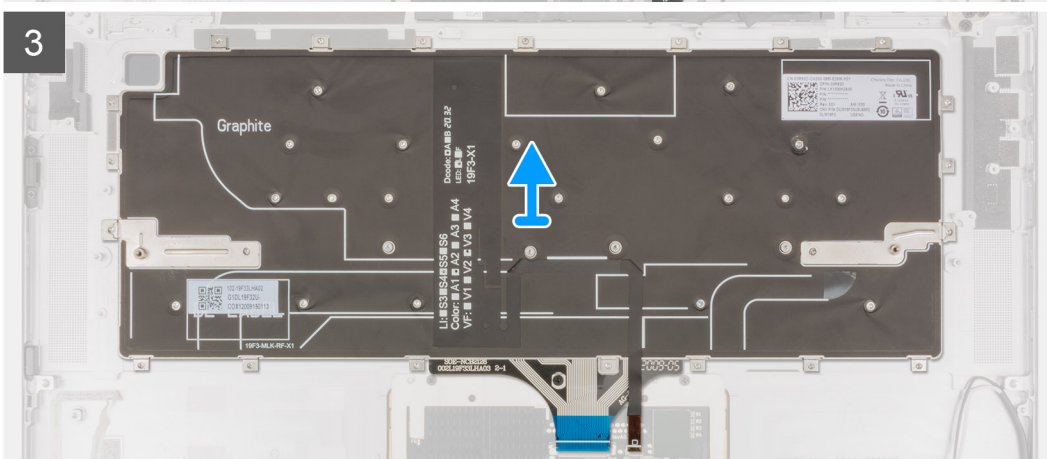
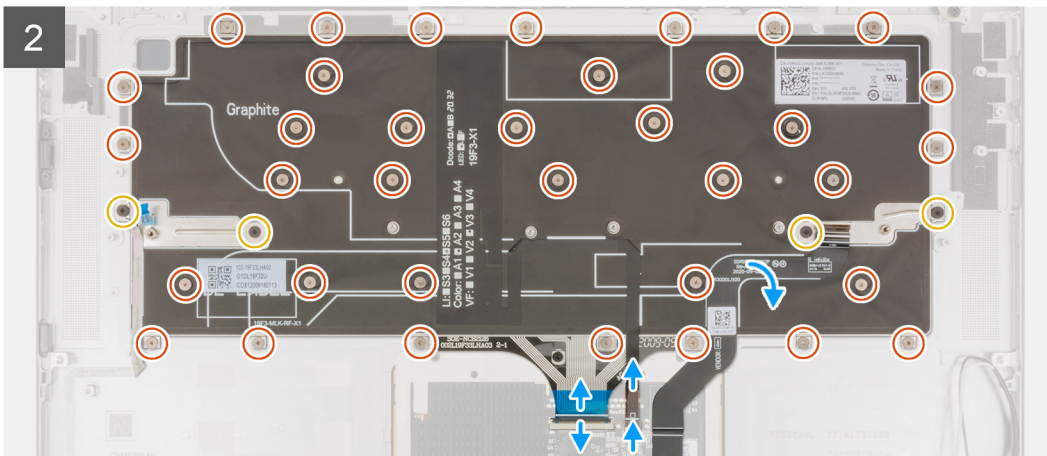
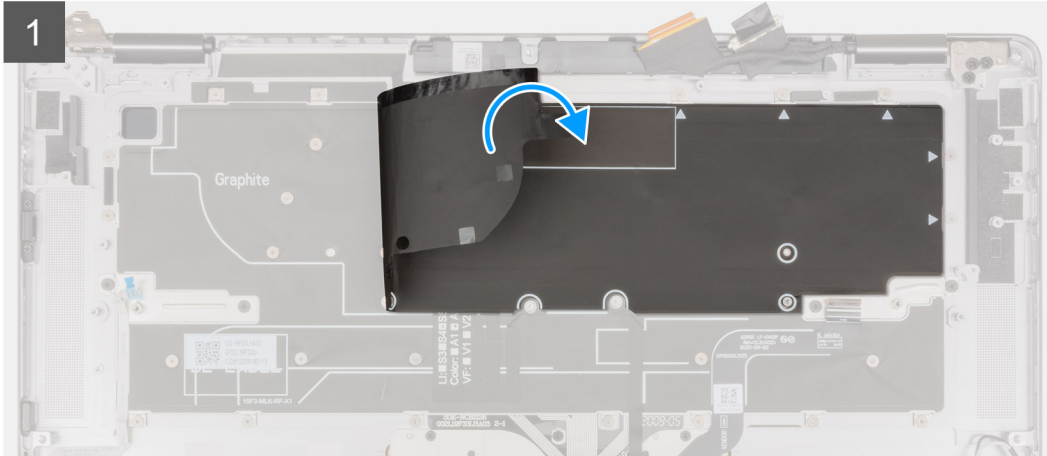
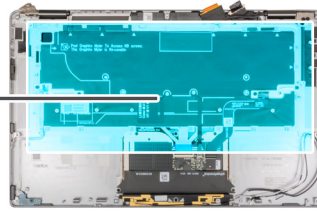

Steps

1. Peel and remove the mylar adhesive sheet from the keyboard.
2. Disconnect the backlight cable and the keyboard cable from the connectors on the touchpad.
3. Peel and remove the touchpad FFC from the keyboard assembly.

4. Remove the four (M1.6x2) and thirty-six (M1.6x1.5) screws that secures the keyboard to the palmrest.
5. Lift the keyboard from the palmrest.

Installing the keyboard

Prerequisites

If you are replacing a component, remove the existing component before performing the installation procedure.

About this task

The following image indicates the location of the keyboard and provides a visual representation of the installation procedure.



36x
M1.6x1.5



4x
M1.6x2

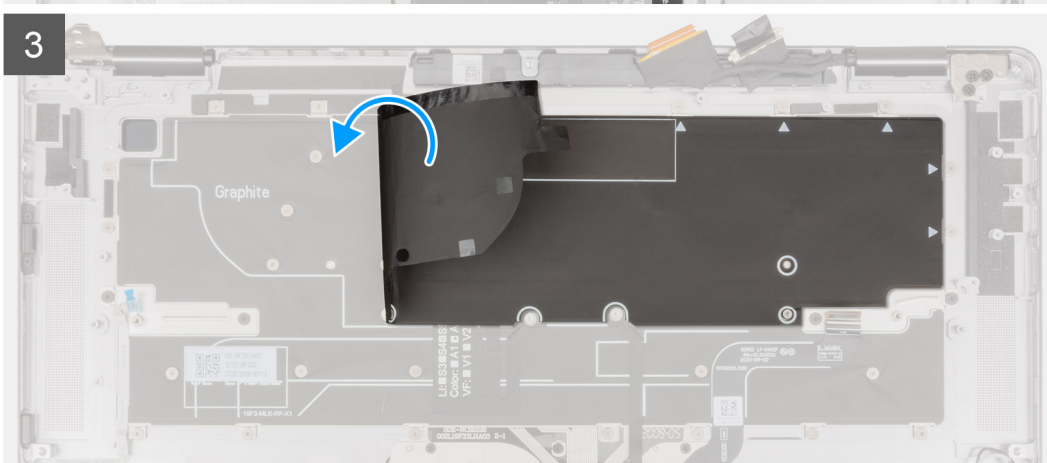
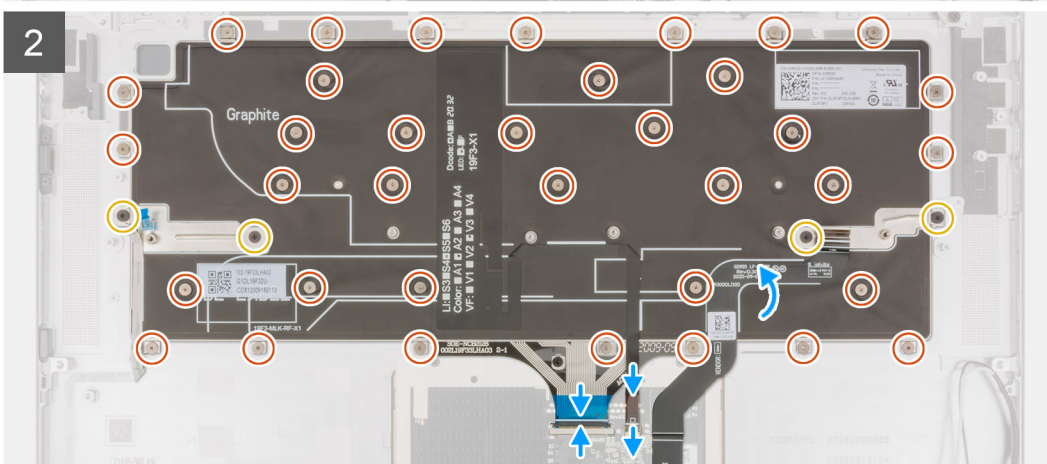
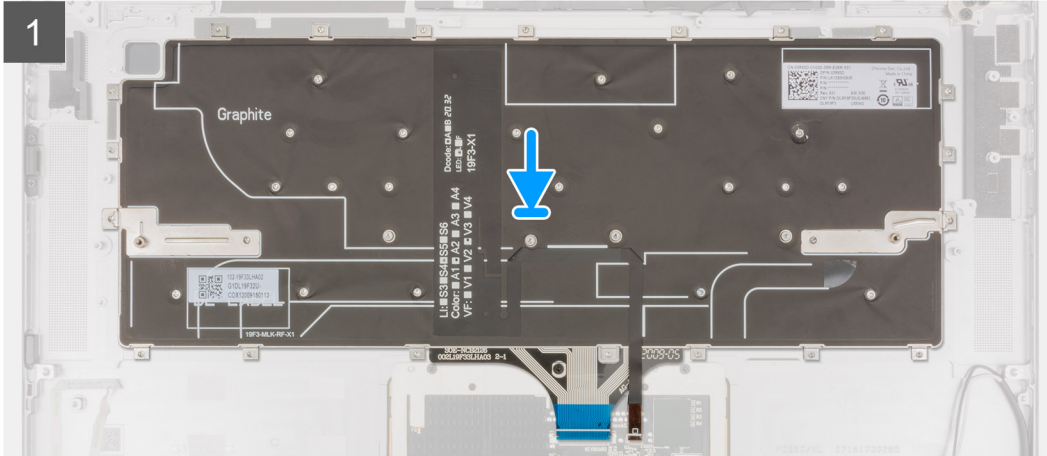
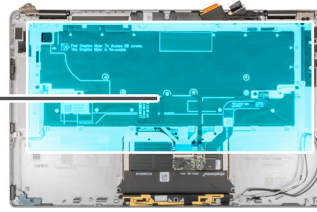

Steps

1. Align and place the keyboard on the palmrest.
2. Install the four (M1.6x2) and thirty-six (M1.6x1.5) screws to secure the keyboard.
3. Adhere the touchpad FFC to the keyboard.

4. Connect the keyboard cable and backlight cable to the connectors on the touchpad.
5. Install the mylar adhesive sheet over the keyboard.

Next steps

1. Install the [system board](#).
2. Install the [I/O daughter board](#).
3. Install the [system fan](#).
4. Install the [display assembly](#).
5. Install the [battery](#).
6. Install the [speakers](#).
7. Install the [WWAN card](#).
8. Install the [solid-state drive](#).
9. Install the [base cover](#).
10. Install the [SIM card](#).
11. Install the [microSD card](#).
12. Follow the procedure in [After working on your computer](#).

Palmrest assembly

Removing the palmrest assembly

Prerequisites

1. Follow the procedure in [before working inside your computer](#).
2. Remove the [microSD card](#).
3. Remove the [SIM card tray](#).
4. Remove the [base cover](#).
5. Remove the [solid-state drive](#).
6. Remove the [WWAN card](#).
7. Remove the [speakers](#).
8. Remove the [battery](#).
9. Remove the [display assembly](#).
10. Remove the [system fan](#).
11. Remove the [I/O daughter board](#).
12. Remove the [power button](#).
13. Remove the [system board](#).
14. Remove the [keyboard](#).

About this task

The following images indicate the location of the palmrest and provide a visual representation of the removal procedure.

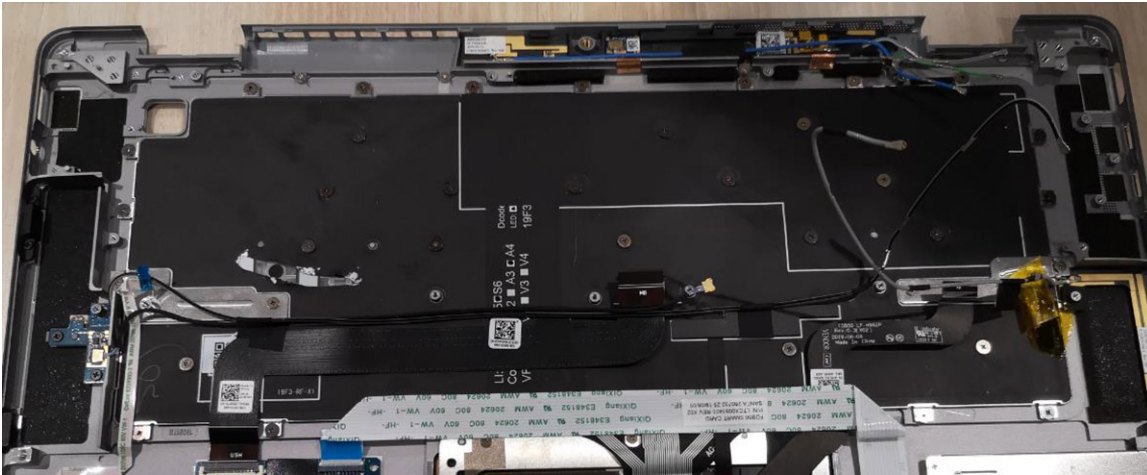

Steps

After performing the preceding steps, you are left with the palmrest assembly.

Next steps

1. Install the [keyboard](#).
2. Install the [system board](#).
3. Install the [power button](#).
4. Install the [I/O daughter board](#).
5. Install the [system fan](#).
6. Install the [display assembly](#).
7. Install the [battery](#).
8. Install the [speakers](#).
9. Install the [WWAN card](#).
10. Install the [solid-state drive](#).
11. Install the [base cover](#).
12. Install the [SIM card tray](#).
13. Install the [microSD card](#).
14. Follow the procedure in [After working on your computer](#).

Software

This chapter details the supported operating systems along with instructions on how to install the drivers.

Topics:

- [Drivers and downloads](#)
- [Operating system](#)

Drivers and downloads

When troubleshooting, downloading or installing drivers it is recommended that you read the Dell Knowledge Based article, Drivers and Downloads FAQ [000123347](#).

Operating system

Your Dell Latitude 9520 supports the following operating systems:

- Windows 11 Home, 64-bit
- Windows 11 Pro, 64-bit
- Windows 11 Pro National Academic, 64-bit
- Windows 10 Home, 64-bit
- Windows 10 Pro, 64-bit
- Ubuntu 20.04 LTS, 64-bit

System setup

CAUTION: Unless you are an expert computer user, do not change the settings in the BIOS Setup program. Certain changes can make your computer work incorrectly.

NOTE: Before you change BIOS Setup program, it is recommended that you write down the BIOS Setup program screen information for future reference.

Use the BIOS Setup program for the following purposes:

- Get information about the hardware installed in your computer, such as the amount of RAM and the size of the hard drive.
- Change the system configuration information.
- Set or change a user-selectable option, such as the user password, type of hard drive installed, and enabling or disabling base devices.

Topics:

- [Boot menu](#)
- [Entering BIOS setup program](#)
- [Navigation keys](#)
- [Boot Sequence](#)
- [System setup options](#)
- [Updating the BIOS](#)
- [System and setup password](#)

Boot menu

Press <F12> when the Dell logo appears to initiate a one-time boot menu with a list of the valid boot devices for the system. Diagnostics and BIOS Setup options are also included in this menu. The devices that are listed on the boot menu depend on the bootable devices in the system. This menu is useful when you are attempting to boot to a particular device or to bring up the diagnostics for the system. Using the boot menu does not make any changes to the boot order stored in the BIOS.

Table 2. UEFI Boot options

| Options |
|----------------------|
| Windows Boot Manager |
| UEFI hard drive |

Table 3. Other Options

| Options | Description |
|----------------------------|---|
| BIOS SETUP | Allows the user to configure the BIOS and control system functions |
| Diagnostics | Allows the user to run system tests to identify issues |
| BIOS Update | Allows the user to search and install the latest BIOS updates |
| SupportAssist OS Recovery | Used to analyze, repair, and restore the operating system on the system |
| BIOS Flash Update - Remote | |
| Device Configuration | |

Entering BIOS setup program

Steps

1. Turn on your computer.
2. Press F2 immediately to enter the BIOS setup program.

 **NOTE:** If you wait too long and the operating system logo appears, continue to wait until you see the desktop. Then, turn off your computer and try again.

Navigation keys

 **NOTE:** For most of the System Setup options, changes that you make are recorded but do not take effect until you restart the system.

| Keys | Navigation |
|-------------------|---|
| Up arrow | Moves to the previous field. |
| Down arrow | Moves to the next field. |
| Enter | Selects a value in the selected field (if applicable) or follow the link in the field. |
| Spacebar | Expands or collapses a drop-down list, if applicable. |
| Tab | Moves to the next focus area. |
| Esc | Moves to the previous page until you view the main screen. Pressing Esc in the main screen displays a message that prompts you to save any unsaved changes and restarts the system. |

Boot Sequence

Boot sequence enables you to bypass the System Setup–defined boot device order and boot directly to a specific device (for example: optical drive or hard drive). During the Power-on Self-Test (POST), when the Dell logo appears, you can:

- Access System Setup by pressing F2 key
- Bring up the one-time boot menu by pressing F12 key.

The one-time boot menu displays the devices that you can boot from including the diagnostic option. The boot menu options are:

- Removable Drive (if available)
- STXXXX Drive
- Optical Drive (if available)
- SATA Hard Drive (if available)
- Diagnostics

 **NOTE:** Choosing **Diagnostics**, displays the **SupportAssist** screen.

The boot sequence screen also displays the option to access the System Setup screen.

System setup options

 **NOTE:** Depending on the laptop and its installed devices, the items listed in this section may or may not appear.

Overview

This section provides hardware specification for the system and contains no modifiable settings.

Table 4. BIOS Overview Page

| Options | Description |
|--------------------------------|--|
| Series and system model number | <p>This field shows the following information:</p> <ul style="list-style-type: none"> ● BIOS Version - The version of the BIOS installed on the computer. ● Service tag - The unique 7 digit hexadecimal identification number for the computer. ● Asset tag ● Manufacture Date - The date for when the unit was manufactured. ● Ownership Date - The date for when the unit's ownership was transferred to the end user. ● Express Service Code - An alternative to Service Tag, 11-digit numerical identification number for the computer. ● Ownership Tag ● Signed Firmware Update - This helps to verify that only Dell Signed and released BIOS can be installed on the computer. |
| Battery | <p>The Battery field provides battery and adapter related information:</p> <ul style="list-style-type: none"> ● Primary battery - This helps identify if the system is running on the primary battery. ● Battery level - This gives the percentage of battery backup remaining for the computer. ● Battery state - This helps identify if the battery is in charging or active use state. ● Health - This helps identify the health of the battery. It would show one of the following states based on the battery life remaining: <ul style="list-style-type: none"> ○ Excellent ○ Good ○ Fair ○ Poor ● AC Adapter - This helps identify if the charger is plugged in and mentions the wattage of the charger connected. |
| Processor | <p>The Processor field provides information related to the CPU on the computer:</p> <ul style="list-style-type: none"> ● Processor Type - This field mentions the CPU model and generation information. ● Maximum Clock Speed - This field mentions the maximum clock speed that the CPU is capable of reaching. ● Minimum Clock Speed - This field mentions the minimum clock speed that the CPU is capable of reaching. ● Current Clock Speed - This field mentions the clock speed that the CPU is running at currently. ● Core Count - This field gives the count of the physical cores on the CPU. ● Processor ID ● Processor L3 Cache - This field shows the amount of cache storage available on the CPU. ● Microcode Version ● Intel Hyper-Threading Capable - This field helps identify if the CPU is capable of Hyper-Threading. ● 64-bit Technology - This field helps identify the CPU architecture. |

Table 4. BIOS Overview Page (continued)

| Options | Description |
|---------|--|
| Memory | <p>The Memory field provides information related to the memory on the computer:</p> <ul style="list-style-type: none"> ● Memory Installed - This field gives the amount of memory installed on the computer. ● Memory Available - This field gives the amount of memory available for use on the computer. ● Memory Speed - This field mentions the speed at which the memory runs on the computer. ● Memory Channel Mode - This field helps us identify if the computer has Dual-Channel memory utilization capability. ● DIMM_SLOT 1 - This field shows the capacity of the memory installed in the first DIMM slot. ● DIMM_SLOT 2 - This field shows the capacity of the memory installed in the second DIMM slot. |
| Devices | <p>The Devices field provides information related to the memory on the computer:</p> <ul style="list-style-type: none"> ● Panel Type - This field mentions the type of display panel used on the computer. ● Video controller - This field mentions the type of video controller used on the computer. ● Video Memory - This field gives the capacity of the video memory available for use on the computer. ● Wi-Fi Device - This field mentions the type of wireless device available for use on the computer. ● Native Resolution - This field mentions the native video resolution supported on the computer. ● Video BIOS Version - The version of the BIOS installed on the computer. ● Audio Controller - This field mentions the type of audio controller used on the computer. ● Bluetooth Device - This field mentions the type of Bluetooth device available for use on the computer. ● LOM MAC Address - This field provides the unique MAC address for the computer. ● Pass Through MAC Address - This field provides the MAC address used to override the dock or dongle MAC address every time it's connected to the network. |

Boot Configuration

This section provides Boot Configuration related details and settings.

Table 5. Boot Configuration:

| Options | Description |
|----------------------|---|
| Boot Sequence | |
| Boot Mode: UEFI only | <p>This section allows the user to choose the first bootable device that the computer should use to boot the system. It lists all potential bootable devices.</p> <ul style="list-style-type: none"> ● Windows Boot Manager (Enabled by default) ● UEFI Boot Drive (Enabled by default) ● Add Boot option - Allows the user to manually add a Boot path. |

Table 5. Boot Configuration: (continued)

| Options | Description |
|------------------------------|---|
| Secure Digital(SD) Card Boot | This section contains a toggle switch that allows the user to enable or disable the option to allow the computer to boot from an SD Card. |
| Secure Boot | |
| Enable Secure Boot | This section contains a toggle switch that allows the user to enable or disable Secure Boot. (OFF by default) |
| Secure Boot Mode | This section allows the user to select one of the two Secure Boot options available on the computer: <ul style="list-style-type: none"> • Deployed Mode - This mode checks the integrity of UEFI drivers and bootloaders before allowing execution. This option allows for full Secure Boot protections (Enabled by default.) • Audit Mode - This mode performs a signature check but never does a block execution of all UEFI drivers and bootloaders. This mode is only used when making changes to Secure Boot Keys. |
| Expert Key Management | |
| Enable Custom Mode | This section contains a toggle switch that allows the user to enable or disable Custom Mode. This mode allows the PK, KEK, db and dbx security key databases to be manipulated. (OFF by default) |
| Custom Mode Key Management | This section helps the user to select the Key Database to allow modification. The options available are as below: <ul style="list-style-type: none"> • PK (Selected by default) • KEK • db • dbx |

Integrated Devices

This section provides Integrated Devices details and settings.

Table 6. Integrated Devices

| Options | Description |
|---------------|--|
| Date/Time | |
| Date | This section allows the user to change the date which takes effect immediately. The format used is MM/DD/YYYY |
| Time | This section allows the user to change the time which takes effect immediately. The format used is HH/MM/SS in 24 hour format. The user also has an option to switch between 12-hours or 24-hours clock. |
| Camera | |
| Enable Camera | This section contains a toggle switch that allows the user to enables/disable the internal webcam (Enabled by default). |
| Audio | |

Table 6. Integrated Devices (continued)

| Options | Description |
|---|---|
| Enable Audio | This section contains a toggle switch that allows the user to enable or disable the audio on the computer. It also allows the user to: <ul style="list-style-type: none"> • Enable Microphone (Enabled by default.) • Enable Internal Speakers (Enabled by default.) |
| USB/Thunderbolt Configuration | This section helps the user to make changes to the USB settings on the computer. The options available are as follows: <ul style="list-style-type: none"> • Enable USB Boot Support - Allows the system to boot from an external USB device (Enabled by default.) • Enable External USB Ports - Allows the user to enable or disable the USB ports on the computer (Enabled by default) |
| Enable Thunderbolt Technology Support | This section contains a toggle switch to enable or disable Thunderbolt technology and the associated ports and adapters (Enabled by default.) |
| Enable Thunderbolt Boot Support | This section contains a toggle switch to enable or disable Thunderbolt Boot support (Disabled by default). When enabled, the system can use Thunderbolt adapter peripherals and USB devices during BIOS pre-boot. |
| Enable Thunderbolt (and PCIe behind TBT) pre-boot modules | This section contains a toggle switch to enable or disable PCIe devices that are connected through a Thunderbolt adapter to execute the PCIe devices UEFI option ROM(s) during pre-boot(Disabled by default). |
| Disable USB4 PCIE Tunneling | This section contains a toggle switch to enable or disable USB4 PCIE Tunneling(Disabled by default). |
| Video/Power only on Type-C Ports | This section contains a toggle switch to limit Type-C port functionality to video or power only (Disabled by default). |
| Type-C Dock Override | This section contains a toggle switch to enable or disable the option to use connected Type-C Dell Dock when keeping external USB ports disabled(Disabled by default). |
| Video | This section contains a toggle switch to enable or disable using Video on Dell external ports (Disabled by default). |
| Audio | This section contains a toggle switch to enable or disable using audio on Dell external ports (Disabled by default). |
| Lan | This section contains a toggle switch to enable or disable using LAN on Dell external ports (Disabled by default). |
| Miscellaneous Devices | |
| Enable Fingerprint Reader Device | This option allows the user to enable the fingerprint reader on the system (Enabled by default). |

Storage

This section provides storage details and settings.

Table 7. Storage

| Options | Description |
|------------------------|--|
| SATA Operation | |
| SATA Operation | This section allows the user to select the operating mode of the integrated SATA hard drive controller. The following options are available: <ul style="list-style-type: none"> • Disabled - SATA controllers are disabled. • AHCI - SATA is configured in AHCI mode. • RAID On - SATA is setup to support RAID (Intel Rapid Storage Technology). (Selected by default) |
| Storage Interface | |
| Port Enablement | This section allows the user to enable or disable the onboard drives on the computer. The following options is available: <ul style="list-style-type: none"> • M.2 PCIe SSD-0 (ON by default). |
| SMART Reporting | |
| Enable SMART Reporting | This section contains a toggle switch that allows the user to enable or disable the S.M.A.R.T.(Self-Monitoring, Analysis, and Reporting Technology) option on the system (OFF by default). |
| Drive Information | This section provides information about the connected and active drives on the computer. The following options are available: <ul style="list-style-type: none"> • M.2 PCIe SSD-0 <ul style="list-style-type: none"> ○ Type ○ Device |
| Enable MediaCard | This section allows the user to switch all media cards On/ Off, or enable/disable the media card in read-state only. The options are as follows: <ul style="list-style-type: none"> • Secure Digital (SD) Card (Enabled by default). • Secure Digital (SD) Card Read-Only Mode (Disabled by default). |

Display

This section provides display details and settings.

Table 8. Display

| Options | Description |
|-----------------------------|--|
| Display Brightness | |
| Brightness on battery power | This section has a scroll bar which allows the user to set the brightness level on battery power (lowest setting by default). |
| Brightness on AC power | This section has a scroll bar which allows the user to set the brightness level when system is connected to the AC adapter (highest setting by default). |
| Touchscreen (Optional) | |
| Touchscreen | This section contains a toggle switch which allows the user to enable/disable touch functionality on the system. |

Table 8. Display (continued)

| Options | Description |
|------------------|--|
| Full Screen Logo | |
| Full Screen Logo | This section contains a toggle switch which allows the user to enable/disable the option to view a full screen logo (disabled by default). |

Connection

This section provides connection details and settings.

Table 9. Connection

| Options | Description |
|---------------------------|---|
| Wireless Device Enable | This section contains a toggle switch that allows the user to enable or disable WLAN and Bluetooth on the computer. The options are as follows: <ul style="list-style-type: none">• WLAN (Enabled by default).• Bluetooth (Enabled by default).• Bluetooth (Enabled by default).• Contactless smartcard/NFC (Enabled by default). |
| Enable UEFI Network Stack | This section contains a toggle switch that allows the user to enable or disable installation of UEFI networking protocols. (ON by default) |
| Wireless Radio Control | This section contains a toggle switch that allows the user to enable or disable a feature where the system will sense a connection to a wired network and disable the WLAN or WWAN connection (OFF by default). |
| HTTP(s) Boot Feature | |
| HTTP(s) Boot Feature | This section contains a toggle switch that allows the user to enable or disable HTTP(s) Boot capabilities (ON by default). |
| HTTP(s) Boot Modes | <ul style="list-style-type: none">• Auto Mode - HTTP(s) Boot automatically extracts Boot URL from DHCP(Dynamic Host Configuration Protocol) - Selected by default.• Manual Mode - HTTP(s) Boot reads Boot URL provided by the user. <p>This section also contains an "Upload" and "Delete" option for provisioning of the certificates required to connect to HTTPs Boot server.</p> |

Power

This section provides power details and settings.

Table 10. Power

| Options | Description |
|-----------------------|--|
| Battery configuration | This section provides options to enable different power modes on the computer. The options are as follows: |

Table 10. Power (continued)



| Options | Description |
|--|--|
| | <ul style="list-style-type: none"> ● Adaptive - battery settings are adaptively optimized based on the users typical battery usage patterns (selected by default). ● Standard - Fully charge the battery at a standard rate. ● ExpressCharge - The battery may be charged over a shorter period using Dell's fast charging technology. ● Primarily AC use - The battery lifespan for users who primarily operate their system while plugged in to an external power source. ● Custom - Custom select when the battery starts and stops charging. <ul style="list-style-type: none"> ○ Custom Charge Start ○ Custom Charge Stop |
| Advanced Configuration | |
| Enable Advanced Battery Charge Configuration | This feature maximizes battery health while still supporting heavy use during the work day. The section contains a toggle switch that allows the user to enable or disable this feature and set the daily times and work time periods (OFF by default). |
| Peak Shift | This feature allows the computer to run on battery during peak usage hours. The section contains a toggle switch that allows the user to enable or disable this feature and set the Peak Shift Start/End times and Peak Shift Charge Start/End (OFF by default). |
| USB PowerShare | This setting contains a toggle switch which allows the user to enable or disable this feature. It allows for any external USB devices to charge via the designated USB PowerShare port, even when the computer is on sleep mode (ON by default). |
| Thermal Management | <p>This setting allows for cooling fan and processor heat management to adjust system performance, noise and temperature. The options available are as below:</p> <ul style="list-style-type: none"> ● Optimized - Standard setting for cooling fan and processor heat management (selected by default). ● Cool - Processor and cooling fan speed are adjusted for a cooler system surface temperature. ● Quiet - Processor and cooling fan speed are adjusted to reduce fan noise. ● Ultra Performance - Processor and cooling fan speed are increased for more performance. |
| USB Wake Support | |
| Enable USB Wake Support | <p>This section contains a toggle switch to allow the user to enable or disable USB Wake Support. It allows the system to use USB devices like a mouse and keyboard to wake the system from standby mode (OFF by default).</p> <p> NOTE: This feature only works if the power adapter is connected to the system.</p> |
| Wake on Dell USB-C Dock | This section contains a toggle switch to allow the user to enable or disable the option to wake on USB-C Dock. This feature allows the system to use a Dell USB-C Dock to wake the system from standby mode (ON by default). |

Table 10. Power (continued)

| Options | Description |
|------------------------------|---|
| |  NOTE: This feature only works if the power adapter is connected to the system. |
| Block Sleep | |
| Block Sleep | This section contains a toggle switch to allow the user to enable or disable the system from entering Sleep(S3) mode in the operating system (OFF by default).  NOTE: When enabled, it will not allow the system to go to sleep, IRST is disabled and power options in the operating system will be blank. |
| LID Switch | |
| Enable Lid Switch | This section contains a toggle switch to allow the user to enable or disable the lid switch (ON by default). |
| Power On Lid Open | This section contains a toggle switch to allow the user to enable or disable the system from powering on when the lid is open (ON by default). |
| Intel Speed Shift Technology | |
| Intel Speed Shift Technology | This section contains a toggle switch to allow the user to enable or disable Intel Speed Shift Technology support. This feature enables the operating system to select appropriate processor performance automatically (ON by default). |

Security

This section provides security details and settings.

Table 11. Security

| Options | Description |
|---------------------|---|
| TPM 2.0 Security | |
| TPM 2.0 Security On | This section contains a toggle switch to select whether Trusted Platform Module(TPM) is visible to the Operating System(OS). (ON by default) |
| Attestation Enable | This section contains a toggle switch which lets the user control whether the TPM Endorsement Hierarchy is available to the operating system (OFF by default). |
| Key Storage Enable | This section contains a toggle switch that allows the user to control whether TPM Storage Hierarchy is available to the operating system (ON by default). |
| SHA-256 | This section contains a toggle switch that when enabled, allows the BIOS and the TPM to use the SHA-256 hash algorithm to extend measurements into the TPM PCRs during BIOS boot (ON by default). |
| Clear | This section contains a toggle switch which clears the TPM owner information, and returns the TPM to the default state (OFF by default). |

Table 11. Security (continued)

| Options | Description |
|-------------------------------|---|
| PPI Bypass for Clear Commands | This section contains a toggle switch which controls the TPM Physical Presence Interface(PPI). When enabled, this setting will allow the OS to skip BIOS PPI user prompts when issuing the clear command (OFF by default). |
| TPM State | This section allows the user to enable or disable the TPM. This is the default operating state for the TPM when you want to use its complete arrays of capabilities (enabled by default). |
| Intel Total Memory Encryption | |
| Total Memory Encryption(TME) | This section allows the user to enable/disable TME to protect memory from physical attacks including freeze spray, probing DDR to read the cycles etc. All of the system memory is encrypted by the TME block attached to the memory controller |
| Chassis Intrusion | |
| Chassis Intrusion | This field controls the chassis intrusion feature <ul style="list-style-type: none"> ● Disabled - Will not report intrusions during POST ● Enabled - Will report intrusions during POST ● On-silent - Detects intrusions but does not display any detected intrusions during POST (Selected by default) |
| Clear Intrusion Warning | This section contains a toggle switch to enable/disable warnings on intrusion (OFF by default). |
| SMM Security Mitigation | This section allows the user to enable or disable UEFI SMM security Mitigation protections (ON by default). |
| Data Wipe on Next Boot | |
| Start Data Wipe | This section contains toggle switch which when enabled ensures that the BIOS will queue up a data wipe cycle for storage device(s) connected to the system board on the next reboot (OFF by default). |
| Absolute | |
| Absolute | This section lets the user enable, disable or permanently disable the BIOS module interface of the optional Absolute Persistence Module service from Absolute Software. The options available are as follows: <ul style="list-style-type: none"> ● Enable Absolute - Enables Absolute Persistence and load the firmware Persistence Module (Selected by default) ● Disable Absolute - Disables Absolute Persistence. The firmware Persistence Module is not installed. ● Permanently Disable Absolute - Permanently disables Absolute Persistence module interface from further use. |
| UEFI Boot Path Security | |
| UEFI Boot Path Security | This section lets the user control whether the system will prompt the user to enter the admin password(if set) when booting to a UEFI boot path device from F12 boot menu. The options available are as below: <ul style="list-style-type: none"> ● Never ● Always ● Always Except Internal HDD (Selected by default) |

Table 11. Security (continued)

| Options | Description |
|-------------|--|
| | <ul style="list-style-type: none"> Always Except Internal HDD&PXE |
| SafeShutter | |
| SafeShutter | <p>This section allows the user to choose between dynamic and manual shutter control:</p> <ul style="list-style-type: none"> Dynamic Shutter - Camera shutter will automatically open when user grants application permission and close when permission ends. Can be disabled by using the F9 camera mute key(LED on). This is the default selected option. Manual Shutter Control - Shutter opens when F9 key is pressed(LED off) and closes when F9 key is pressed(LED on) |

Passwords

This section provides details on password settings.

Table 12. Passwords

| Options | Description |
|-----------------------|---|
| Admin Password | This field allows the user to set, change, or delete the administrator password. |
| System Password | This field allows the user to set, change, or delete the system password. |
| NVMe SSD0 | This field allows the user to set, change, or delete the storage drive password. |
| Password Configurator | |
| Upper Case Letter | Enable or disable reinforced use of upper case letters (OFF by default). |
| Lower Case Letter | Enable or disable reinforced use of lower case letters (OFF by default). |
| Digit | Enable or disable reinforced use of at least one digit (OFF by default). |
| Special Character | Enable or disable reinforced use of at least one special character (OFF by default). |
| Minimum Character | Allows the user to select the number of characters allowed for a password (4 is the default value). |
| Password Bypass | |
| Password Bypass | <p>When enabled, this always prompts for system and internal hard drive passwords when powered on from Off state. Options available are as below:</p> <ul style="list-style-type: none"> Disabled (selected by default) Reboot Bypass |
| Password Changes | |

Table 12. Passwords (continued)

| Options | Description |
|-----------------------------------|---|
| Enable Non-Admin Password Changes | This section contains a toggle switch which when on, user can change system and hard drive password without the need for admin password (OFF by default). |
| Admin Setup Lockout | |
| Enable Admin Setup Lockout | This section contains a toggle switch which allows the administrator to control how users can or cannot access BIOS setup (OFF by default). |
| Active Password Lockout | |
| Enable Active Password Lockout | This section contains a toggle switch which allows the user to disable active password support (OFF by default). |

Update Recovery

This section provides details on Update Recovery settings.

Table 13. Update Recovery

| Options | Description |
|--------------------------------------|---|
| UEFI capsule Firmware Updates | |
| Enable UEFI Capsule Firmware Updates | This field contains a toggle switch which allows the user to enable or disable BIOS updates through UEFI capsule update packages (ON by default). |
| BIOS Recovery from Hard Drive | |
| BIOS Recovery from Hard Drive | This field contains a toggle switch which allows the user to enable or disable recovery from certain corrupted BIOS conditions from a recovery file on the user's primary hard drive or an external USB key (ON by default). |
| BIOS Downgrade | |
| Allow BIOS Downgrade | This field contains a toggle switch which allows the user to enable or disable flashing of the system firmware to previous revisions. |
| SupportAssist OS Recovery | |
| SupportAssist OS Recovery | This field contains a toggle switch which allows the user to enable or disable the boot flow for SupportAssist OS Recovery tool in the events of certain system errors (ON by default). |
| BIOSConnect | |
| BIOSConnect | This field contains a toggle switch which allows the user to enable or disable BIOSConnect setup to attempt cloud Service OS recovery if the main operating system fails to boot with a set number of failures (ON by default). |
| Dell Auto OS Recovery Threshold | |
| Dell Auto OS Recovery Threshold | This field allows the user to select the number of failed boot attempts by the system before SupportAssist OS Recovery is triggered. The options here are as below: |

Table 13. Update Recovery (continued)

| Options | Description |
|---------|--|
| | <ul style="list-style-type: none"> • Off • 1 • 2 (selected by default) • 3 |

System Management

This section provides System Management settings.

Table 14. System Management

| Options | Description |
|-----------------------------|--|
| Service Tag | |
| Service Tag | This field provides the unique Service Tag of the computer. |
| Asset Tag | |
| Asset Tag | This field provides the asset tag which is a unique and up to 64-character identification that can be set by the IT administrator. |
| AC Behaviour | |
| Wake on AC | This field contains a toggle switch which allows the user to enable or disable the feature where the system boots when charger is detected (OFF by default). |
| Wake on LAN | |
| Wake on LAN | <p>This field allows the user to select if and how the system should boot when connected to LAN. The options here are as follows:</p> <ul style="list-style-type: none"> • Disabled - The system will not boot with any special LAN signals (selected by default). • LAN only - Allows the system to be powered on by a special LAN signal from a network computer. • LAN with PXE Boot - Allows the system to wake-up from S4 or S5 state and boot to PXE. |
| Auto On Time | |
| Auto On Time | <p>This field allows the user to set defined days/time when the system can automatically power on. The options here are as follows:</p> <ul style="list-style-type: none"> • Disabled (selected by default) • Everyday • Weekdays • Select Days |
| Intel AMT Capability | |
| Enable Intel AMT capability | <p>This section allows the user to control AMT options on the system:</p> <ul style="list-style-type: none"> • Disabled • Enabled • Restrict MEBx Access - Selected by default |

Table 14. System Management (continued)

| Options | Description |
|---------------|---|
| MEBx Hotkey | This field contains a toggle switch which allows the user to enable or disable Ctrl-P hotkey to access MEBx. |
| USB Provision | This field contains a toggle switch which allows the user to enable or disable Intel AMT from provisioning using local files via USB storage device (OFF by default). |

Keyboard

This section provides keyboard settings.

Table 15. Keyboard

| Options | Description |
|---------------------------------------|--|
| Fn Lock Options | |
| Fn Lock Options | This field contains a toggle switch to change the mode of the function keys (ON by default). The options are as follows: <ul style="list-style-type: none"> • Lock Mode Standard - Traditional F1-F12 functions • Lock Mode Secondary - Enables secondary functions on the Fn keys (selected by default) |
| Keyboard Illumination | |
| Keyboard Illumination | This field allows the user to set the keyboard illumination settings. The options available are as follows: <ul style="list-style-type: none"> • Disabled - The keyboard illumination will be off • Dim - Enable the keyboard illumination feature at 50% brightness level • Bright - Enable the keyboard illumination feature at 100% brightness level (selected by default) |
| Keyboard Backlight Timeout on AC | |
| Keyboard Backlight Timeout on AC | This field allows the user to define the timeout value for the backlight when the AC adapter is connected to the computer. The options here are as follows: <ul style="list-style-type: none"> • 5 seconds • 10 seconds (selected by default) • 15 seconds • 30 seconds • 1 minute • 5 minutes • 15 minutes • Never |
| Keyboard Backlight Timeout on Battery | |
| Keyboard Backlight Timeout on Battery | This field allows the user to define the timeout value for the backlight when the battery is powering to the computer. The options here are as follows: <ul style="list-style-type: none"> • 5 seconds • 10 seconds (selected by default) • 15 seconds • 30 seconds • 1 minute |

Table 15. Keyboard (continued)

| Options | Description |
|------------------------------------|--|
| | <ul style="list-style-type: none"> • 5 minutes • 15 minutes • Never |
| Device Configuration Hotkey Access | |
| Device Configuration Hotkey Access | <p>This setting controls whether the user can access device configuration screens via hotkeys during system startup. The options here are as follows:</p> <ul style="list-style-type: none"> • Enabled (selected by default) • One Time Enable • Disabled |

Pre-boot Behavior

This section provides Pre-boot Behavior details and settings.

Table 16. Pre-boot Behavior

| Options | Description |
|------------------------------|---|
| Adapter Warnings | |
| Enable Adapter Warnings | This field contains a toggle switch to enable or disable warning messages during boot when adapters with low power capacity are detected (enabled by default). |
| Warning and Errors | |
| Warning and Errors | <p>This field allows the user to enable or disable boot process to be paused only when warnings or errors are detected. The options are as follows:</p> <ul style="list-style-type: none"> • Prompt on Warnings and Errors - Stop, prompt and wait for user input when warnings or errors are detected (selected by default) • Continue on Warnings - Continue when warnings are detected but pause on errors • Continue on Warnings and Errors - Continue when either warnings or errors are detected during POST |
| USB-C Warnings | |
| Enable Dock Warning Messages | This field contains a toggle switch to enable or disable dock warning messages (enabled by default). |
| Fastboot | |
| Fastboot | <p>This field allows the user to configure the speed of the UEFI boot process. The options here are as follows:</p> <ul style="list-style-type: none"> • Minimal - reduces boot time by skipping certain hardware and configuration initialization during boot (selected by default) • Thorough - Performs complete hardware and configuration initialization during boot • Auto - Allows the BIOS to decide configuration initialization performed during boot |
| Extend BIOS POST Time | |

Table 16. Pre-boot Behavior (continued)

| Options | Description |
|--------------------------|---|
| Extend BIOS POST Time | This field allows the user to configure the BIOS POST load time. The options are as follows: <ul style="list-style-type: none"> ● 0 seconds (selected by default) ● 5 seconds ● 10 seconds |
| MAC Address Pass-Through | |
| MAC Address Pass-Through | This field allows the user to configure the MAC address pass-through replacing the external NIC MAC address.: <ul style="list-style-type: none"> ● System Unique MAC Address (selected by default) ● Integrated NIC 1 MAC Address ● Disabled |

Virtualization

This section provides details on Virtualization settings.

Table 17. Virtualization

| Options | Description |
|--|--|
| Intel Virtualization Technology | |
| Enable Intel Virtualization Technology(VT) | This field contains a toggle switch to enable or disable Virtualization to run Virtual machine monitor(VMM) (enabled by default). |
| VT for Direct I/O | |
| Enable Intel VT for Direct I/O | This field allows the user to enable or disable the system from being able to perform VT for Direct I/O (enabled by default). |
| Intel Trusted Execution Technology(TXT) | |
| Enable Intel Trusted Execution Technology(TXT) | This field contains a toggle switch to enable or disable the option to allow a Measured VMM to utilize the additional hardware capabilities provided by Intel TXT (OFF by default). The following must be enabled to configure Intel TXT: <ul style="list-style-type: none"> ● Trusted Platform Module(TPM) ● Intel Hyper-Threading ● All CPU cores(Multi-Core Support) ● Intel Virtualization technology ● Intel VT for Direct I/O |

Performance

This section provides Performance settings.

Table 18. Performance

| Options | Description |
|--------------------|---|
| Multi-Core Support | |
| Active Cores | This field allows the user to configure the number of active cores on the computer. The options are as follows: |

Table 18. Performance (continued)

| Options | Description |
|---|---|
| | <ul style="list-style-type: none"> • All Cores (selected by default) • 1 • 2 • 3 |
| Intel SpeedStep | |
| Enable Intel SpeedStep Technology | This field contains a toggle switch to enable or disable Intel SpeedStep Technology which allows the computer to dynamically adjust processor voltage and core frequency, decreasing average power consumption and heat production (enabled by default). |
| C-States Control | |
| Enable C-States Control | This field contains a toggle switch to enable or disable C-States Control that configures the CPU's ability to enter and exit low power states. When off, it disables all C-States (enabled by default). |
| Intel Turbo Boost Technology | |
| Enable Intel Turbo Boost Technology | <p>This field allows the user to enable or disable Intel Turbo Boost Technology (enabled by default).</p> <ul style="list-style-type: none"> • Disabled - Does not allow the Intel Turbo Boost Technology driver to increase the performance state of the processor above the standard performance. • Enabled - Allows the Intel Turbo Boost Technology to increase the performance of the CPU or graphics processor. |
| Intel Hyper-Threading Technology | |
| Enable Intel Hyper-Threading Technology | This field allows the user to configure this feature where the processor resources are used more effectively, enabling multiple threads to run on each core (enabled by default). |
| Dynamic Tuning: Machine Learning | |
| Enable Dynamic Tuning: Machine Learning | This field allows the user to configure the OS' capability to enhance dynamic power tuning capabilities based on detected workloads (disabled by default) |

System Logs

This section contains BIOS, Thermal and Power event logs.

Table 19. System Logs

| Options | Description |
|----------------------|---|
| BIOS Event Log | |
| Clear BIOS Event log | This field contains a toggle switch to Keep or Clear BIOS Event logs. It also lists all saved events(Date, Time, Message) - ("Keep" selected by default). |
| Thermal Event Log | |

Table 19. System Logs (continued)

| Options | Description |
|-------------------------|--|
| Clear Thermal Event Log | This field contains a toggle switch to Keep or Clear Thermal Event logs. It also lists all saved events(Date, Time, Message) - ("Keep" selected by default). |
| Power Event Log | |
| Clear Power Event Log | This field contains a toggle switch to Keep or Clear Power Event logs. It also lists all saved events(Date, Time, Message) - ("Keep" selected by default). |

Updating the BIOS

Updating the BIOS in Windows

About this task

CAUTION: If BitLocker is not suspended before updating the BIOS, the next time you reboot the system it will not recognize the BitLocker key. You will then be prompted to enter the recovery key to progress and the system will ask for this on each reboot. If the recovery key is not known this can result in data loss or an unnecessary operating system re-install. For more information on this subject, see Knowledge Article: <https://www.dell.com/support/article/sln153694>

Steps

1. Go to www.dell.com/support.
2. Click **Product support**. In the **Search support** box, enter the Service Tag of your computer, and then click **Search**.
NOTE: If you do not have the Service Tag, use the SupportAssist feature to automatically identify your computer. You can also use the product ID or manually browse for your computer model.
3. Click **Drivers & Downloads**. Expand **Find drivers**.
4. Select the operating system installed on your computer.
5. In the **Category** drop-down list, select **BIOS**.
6. Select the latest version of BIOS, and click **Download** to download the BIOS file for your computer.
7. After the download is complete, browse the folder where you saved the BIOS update file.
8. Double-click the BIOS update file icon and follow the on-screen instructions.
For more information, see knowledge base article [000124211](http://www.dell.com/support) at www.dell.com/support.

Updating the BIOS in Linux and Ubuntu

To update the system BIOS on a computer that is installed with Linux or Ubuntu, see the knowledge base article [000131486](http://www.dell.com/support) at www.dell.com/support.

Updating the BIOS using the USB drive in Windows

About this task

CAUTION: If BitLocker is not suspended before updating the BIOS, the next time you reboot the system it will not recognize the BitLocker key. You will then be prompted to enter the recovery key to progress and the system will ask for this on each reboot. If the recovery key is not known this can result in data loss or an unnecessary operating system re-install. For more information on this subject, see Knowledge Article: <https://www.dell.com/support/article/sln153694>

Steps

1. Follow the procedure from step 1 to step 6 in [Updating the BIOS in Windows](#) to download the latest BIOS setup program file.
2. Create a bootable USB drive. For more information, see the knowledge base article [000145519](#) at www.dell.com/support.
3. Copy the BIOS setup program file to the bootable USB drive.
4. Connect the bootable USB drive to the computer that needs the BIOS update.
5. Restart the computer and press **F12**.
6. Select the USB drive from the **One Time Boot Menu**.
7. Type the BIOS setup program filename and press **Enter**.
The **BIOS Update Utility** appears.
8. Follow the on-screen instructions to complete the BIOS update.

Updating the BIOS from the F12 One-Time boot menu

Update your computer BIOS using the BIOS update.exe file that is copied to a FAT32 USB drive and booting from the F12 One-Time boot menu.

About this task

CAUTION: If BitLocker is not suspended before updating the BIOS, the next time you reboot the system it will not recognize the BitLocker key. You will then be prompted to enter the recovery key to progress and the system will ask for this on each reboot. If the recovery key is not known this can result in data loss or an unnecessary operating system re-install. For more information on this subject, see Knowledge Article: <https://www.dell.com/support/article/sln153694>

BIOS Update

You can run the BIOS update file from Windows using a bootable USB drive or you can also update the BIOS from the F12 One-Time boot menu on the computer.

Most of the Dell computers built after 2012 have this capability, and you can confirm by booting your computer to the F12 One-Time Boot Menu to see if BIOS FLASH UPDATE is listed as a boot option for your computer. If the option is listed, then the BIOS supports this BIOS update option.

NOTE: Only computers with BIOS Flash Update option in the F12 One-Time boot menu can use this function.

Updating from the One-Time boot menu

To update your BIOS from the F12 One-Time boot menu, you need the following:

- USB drive formatted to the FAT32 file system (key does not have to be bootable)
- BIOS executable file that you downloaded from the Dell Support website and copied to the root of the USB drive
- AC power adapter that is connected to the computer
- Functional computer battery to flash the BIOS

Perform the following steps to perform the BIOS update flash process from the F12 menu:

CAUTION: Do not turn off the computer during the BIOS update process. The computer may not boot if you turn off your computer.

Steps

1. From a turn off state, insert the USB drive where you copied the flash into a USB port of the computer.
2. Turn on the computer and press F12 to access the One-Time Boot Menu, select BIOS Update using the mouse or arrow keys then press Enter.
The flash BIOS menu is displayed.
3. Click **Flash from file**.
4. Select external USB device.
5. Select the file and double-click the flash target file, and then click **Submit**.
6. Click **Update BIOS**. The computer restarts to flash the BIOS.
7. The computer will restart after the BIOS update is completed.

System and setup password

Table 20. System and setup password

| Password type | Description |
|-----------------|--|
| System password | Password that you must enter to log on to your system. |
| Setup password | Password that you must enter to access and make changes to the BIOS settings of your computer. |

You can create a system password and a setup password to secure your computer.

 **CAUTION:** The password features provide a basic level of security for the data on your computer.

 **CAUTION:** Anyone can access the data stored on your computer if it is not locked and left unattended.

 **NOTE:** System and setup password feature is disabled.

Assigning a system setup password

Prerequisites

You can assign a new **System or Admin Password** only when the status is **Not Set**.

About this task

To enter the system setup, press F2 immediately after a power-on or reboot.

Steps

1. In the **System BIOS** or **System Setup** screen, select **Security** and press **Enter**.
The **Security** screen is displayed.
2. Select **System/Admin Password** and create a password in the **Enter the new password** field.
Use the following guidelines to assign the system password:
 - A password can have up to 32 characters.
 - The password can contain the numbers 0 through 9.
 - Only lower case letters are valid, upper case letters are not allowed.
 - Only the following special characters are allowed: space, ("), (+), (.), (-), (.), (/), (;), ([), (\), (]), (`).
3. Type the system password that you entered earlier in the **Confirm new password** field and click **OK**.
4. Press **Esc** and a message prompts you to save the changes.
5. Press **Y** to save the changes.
The computer reboots.

Deleting or changing an existing system setup password

Prerequisites

Ensure that the **Password Status** is Unlocked (in the System Setup) before attempting to delete or change the existing System and Setup password. You cannot delete or change an existing System or Setup password, if the **Password Status** is Locked.

About this task

To enter the System Setup, press **F2** immediately after a power-on or reboot.

Steps

1. In the **System BIOS** or **System Setup** screen, select **System Security** and press **Enter**.

The **System Security** screen is displayed.

2. In the **System Security** screen, verify that **Password Status** is **Unlocked**.
3. Select **System Password**, alter or delete the existing system password and press **Enter** or **Tab**.
4. Select **Setup Password**, alter or delete the existing setup password and press **Enter** or **Tab**.

 **NOTE:** If you change the System and/or Setup password, re enter the new password when prompted. If you delete the System and Setup password, confirm the deletion when prompted.

5. Press **Esc** and a message prompts you to save the changes.
6. Press **Y** to save the changes and exit from System Setup.
The computer restarts.

Troubleshooting

Topics:

- [Handling swollen Lithium-ion batteries](#)
- [Dell SupportAssist Pre-boot System Performance Check diagnostics](#)
- [Diagnostics](#)
- [Recovering the operating system](#)
- [Diagnostic error messages](#)
- [System error messages](#)
- [Backup media and recovery options](#)
- [Wi-Fi power cycle](#)

Handling swollen Lithium-ion batteries

Like most laptops, Dell laptops use lithium-ion batteries. One type of lithium-ion battery is the lithium-ion polymer battery. Lithium-ion polymer batteries have increased in popularity in recent years and have become standard in the electronics industry due to customer preferences for a slim form factor (especially with newer ultra-thin laptops) and long battery life. Inherent to lithium-ion polymer battery technology is the potential for swelling of the battery cells.

Swollen battery may impact the performance of the laptop. To prevent possible further damage to the device enclosure or internal components leading to malfunction, discontinue the use of the laptop and discharge it by disconnecting the AC adapter and letting the battery drain.

Swollen batteries should not be used and should be replaced and disposed of properly. We recommend contacting Dell product support for options to replace a swollen battery under the terms of the applicable warranty or service contract, including options for replacement by a Dell authorized service technician.

The guidelines for handling and replacing Lithium-ion batteries are as follows:

- Exercise caution when handling Lithium-ion batteries.
- Discharge the battery before removing it from the system. To discharge the battery, unplug the AC adapter from the system and operate the system only on battery power. When the system will no longer power on when the power button is pressed, the battery is fully discharged.
- Do not crush, drop, mutilate, or penetrate the battery with foreign objects.
- Do not expose the battery to high temperatures, or disassemble battery packs and cells.
- Do not apply pressure to the surface of the battery.
- Do not bend the battery.
- Do not use tools of any type to pry on or against the battery.
- If a battery gets stuck in a device as a result of swelling, do not try to free it as puncturing, bending, or crushing a battery can be dangerous.
- Do not attempt to reassemble a damaged or swollen battery into a laptop.
- Swollen batteries that are covered under warranty should be returned to Dell in an approved shipping container (provided by Dell)—this is to comply with transportation regulations. Swollen batteries that are not covered under warranty should be disposed of at an approved recycling center. Contact Dell product support at <https://www.dell.com/support> for assistance and further instructions.
- Using a non-Dell or incompatible battery may increase the risk of fire or explosion. Replace the battery only with a compatible battery purchased from Dell that is designed to work with your Dell computer. Do not use a battery from other computers with your computer. Always purchase genuine batteries from <https://www.dell.com> or otherwise directly from Dell.

Lithium-ion batteries can swell for various reasons such as age, number of charge cycles, or exposure to high heat. For more information on how to improve the performance and lifespan of the laptop battery and to minimize the possibility of occurrence of the issue, see [Dell Laptop Battery - Frequently Asked Questions](#).

Dell SupportAssist Pre-boot System Performance Check diagnostics

About this task

SupportAssist diagnostics (also known as system diagnostics) performs a complete check of your hardware. The Dell SupportAssist Pre-boot System Performance Check diagnostics is embedded with the BIOS and is launched by the BIOS internally. The embedded system diagnostics provides a set of options for particular devices or device groups allowing you to:

- Run tests automatically or in an interactive mode
- Repeat tests
- Display or save test results
- Run thorough tests to introduce additional test options to provide extra information about the failed device(s)
- View status messages that inform you if tests are completed successfully
- View error messages that inform you of problems encountered during testing

NOTE: Some tests for specific devices require user interaction. Always ensure that you are present at the computer terminal when the diagnostic tests are performed.

For more information, see <https://www.dell.com/support/kbdoc/000180971>.

Running the SupportAssist Pre-Boot System Performance Check

Steps

1. Turn on your computer.
2. As the computer boots, press the F12 key as the Dell logo appears.
3. On the boot menu screen, select the **Diagnostics** option.
4. Click the arrow at the bottom left corner.
Diagnostics front page is displayed.
5. Click the arrow in the lower-right corner to go to the page listing.
The items detected are listed.
6. To run a diagnostic test on a specific device, press Esc and click **Yes** to stop the diagnostic test.
7. Select the device from the left pane and click **Run Tests**.
8. If there are any issues, error codes are displayed.
Note the error code and validation number and contact Dell.

Diagnostics

Instead of beep codes, errors are indicated by the bicolor Battery Charge/Status LED. A specific blink pattern is followed by flashing a pattern of flashes in amber, followed by white.

The diagnostic pattern consists of a two-digit number being represented by a first group of LED blinks (1 through 9) in amber, followed by a 1.5 second pause with the LED off, and then a second group of LED blinks (1 through 9) in white. This is then followed by a three second pause, with the LED off, before repeating over again. Each LED blink takes 1.5 seconds.

The system will not shut down when displaying the Diagnostic Error Codes. Diagnostic Error Codes will always supersede any other use of the LED. For instance, on Notebooks, battery codes for Low Battery or Battery Failure situations will not be displayed when Diagnostic Error Codes are being displayed.

Table 21. Diagnostic LED states

| Amber LED state | White LED state | System state | Notes |
|-----------------|-----------------|--------------|--|
| 2 | 1 | CPU failure | Run the Intel CPU diagnostics tools If problem persists, replace the system board |

Table 21. Diagnostic LED states (continued)

| Amber LED state | White LED state | System state | Notes |
|------------------------|------------------------|--|---|
| 2 | 2 | System board failure (included BIOS corruption or ROM error) | Flash latest BIOS version If problem persists, replace the system board |
| 2 | 3 | No memory/ RAM detected | Confirm that the memory module is installed properly If problem persists, replace the system board |
| 2 | 4 | Memory/ RAM failure | Reset the memory module If problem persists, replace the system board |
| 2 | 5 | Invalid memory installed | Reset the memory module If problem persists, replace the system board |
| 2 | 6 | System board/ Chipset error | Flash latest BIOS version If problem persists, replace the system board |
| 2 | 7 | LCD failure | Flash latest BIOS version If problem persists, replace the system board |
| 2 | 8 | LCD Power rail failure | Replace the system board |
| 3 | 1 | CMOS battery failure | Reset the CMOS battery connection If problem persists, replace the system board |
| 3 | 2 | PCI or Video card/ chip failure | Replace the system board |
| 3 | 3 | BIOS Recovery Image not found | Flash latest BIOS version If problem persists, replace the system board |
| 3 | 4 | BIOS Recovery Image found but invalid | Flash latest BIOS version If problem persists, replace the system board |
| 3 | 5 | Power rail failure | EC ran into power sequencing failure If problem persists, replace the system board |
| 3 | 6 | SBIOS Flash Corruption | Flash corruption detected by SBIOS If problem persists, replace the system board |
| 3 | 7 | ME error | Timeout waiting on ME to reply to HECI message |

Table 21. Diagnostic LED states (continued)

| Amber LED state | White LED state | System state | Notes |
|-----------------|-----------------|--------------|---|
| | | | If problem persists, replace the system board |

NOTE: For diagnostics pattern 2-amber, 8-white connect an external monitor to isolate between system board or graphics controller failure.

Recovering the operating system

When your computer is unable to boot to the operating system even after repeated attempts, it automatically starts Dell SupportAssist OS Recovery.

Dell SupportAssist OS Recovery is a standalone tool that is preinstalled in all Dell computers installed with Windows operating system. It consists of tools to diagnose and troubleshoot issues that may occur before your computer boots to the operating system. It enables you to diagnose hardware issues, repair your computer, back up your files, or restore your computer to its factory state.

You can also download it from the Dell Support website to troubleshoot and fix your computer when it fails to boot into their primary operating system due to software or hardware failures.

For more information about the Dell SupportAssist OS Recovery, see *Dell SupportAssist OS Recovery User's Guide* at www.dell.com/serviceabilitytools. Click **SupportAssist** and then, click **SupportAssist OS Recovery**.

Diagnostic error messages

Table 22. Diagnostic error messages

| Error messages | Description |
|----------------------------------|--|
| AUXILIARY DEVICE FAILURE | The touchpad or external mouse may be faulty. For an external mouse, check the cable connection. Enable the Pointing Device option in the System Setup program. |
| BAD COMMAND OR FILE NAME | Ensure that you have spelled the command correctly, put spaces in the proper place, and used the correct path name. |
| CACHE DISABLED DUE TO FAILURE | The primary cache internal to the microprocessor has failed. Contact Dell |
| CD DRIVE CONTROLLER FAILURE | The optical drive does not respond to commands from the computer. |
| DATA ERROR | The hard drive cannot read the data. |
| DECREASING AVAILABLE MEMORY | One or more memory modules may be faulty or improperly seated. Reinstall the memory modules or, if necessary, replace them. |
| DISK C: FAILED INITIALIZATION | The hard drive failed initialization. Run the hard drive tests in Dell Diagnostics . |
| DRIVE NOT READY | The operation requires a hard drive in the bay before it can continue. Install a hard drive in the hard drive bay. |
| ERROR READING PCMCIA CARD | The computer cannot identify the ExpressCard. Reinsert the card or try another card. |
| EXTENDED MEMORY SIZE HAS CHANGED | The amount of memory recorded in non-volatile memory (NVRAM) does not match the memory module installed in the computer. Restart the computer. If the error appears again, Contact Dell |

Table 22. Diagnostic error messages (continued)

| Error messages | Description |
|--|--|
| THE FILE BEING COPIED IS TOO LARGE FOR THE DESTINATION DRIVE | The file that you are trying to copy is too large to fit on the disk, or the disk is full. Try copying the file to a different disk or use a larger capacity disk. |
| A FILENAME CANNOT CONTAIN ANY OF THE FOLLOWING CHARACTERS: \ / : * ? " < > - | Do not use these characters in filenames. |
| GATE A20 FAILURE | A memory module may be loose. Reinstall the memory module or, if necessary, replace it. |
| GENERAL FAILURE | The operating system is unable to carry out the command. The message is usually followed by specific information. For example, Printer out of paper. Take the appropriate action. |
| HARD-DISK DRIVE CONFIGURATION ERROR | The computer cannot identify the drive type. Shut down the computer, remove the hard drive, and boot the computer from an optical drive. Then, shut down the computer, reinstall the hard drive, and restart the computer. Run the Hard Disk Drive tests in Dell Diagnostics . |
| HARD-DISK DRIVE CONTROLLER FAILURE 0 | The hard drive does not respond to commands from the computer. Shut down the computer, remove the hard drive, and boot the computer from an optical drive. Then, shut down the computer, reinstall the hard drive, and restart the computer. If the problem persists, try another drive. Run the Hard Disk Drive tests in Dell Diagnostics . |
| HARD-DISK DRIVE FAILURE | The hard drive does not respond to commands from the computer. Shut down the computer, remove the hard drive, and boot the computer from an optical drive. Then, shut down the computer, reinstall the hard drive, and restart the computer. If the problem persists, try another drive. Run the Hard Disk Drive tests in Dell Diagnostics . |
| HARD-DISK DRIVE READ FAILURE | The hard drive may be defective. Shut down the computer, remove the hard drive, and boot the computer from an optical drive. Then, shut down the computer, reinstall the hard drive, and restart the computer. If the problem persists, try another drive. Run the Hard Disk Drive tests in Dell Diagnostics . |
| INSERT BOOTABLE MEDIA | The operating system is trying to boot to non-bootable media, such as an optical drive. Insert bootable media. |
| INVALID CONFIGURATION INFORMATION-PLEASE RUN SYSTEM SETUP PROGRAM | The system configuration information does not match the hardware configuration. The message is most likely to occur after a memory module is installed. Correct the appropriate options in the system setup program. |
| KEYBOARD CLOCK LINE FAILURE | For external keyboards, check the cable connection. Run the Keyboard Controller test in Dell Diagnostics . |
| KEYBOARD CONTROLLER FAILURE | For external keyboards, check the cable connection. Restart the computer, and avoid touching the keyboard or the mouse during the boot routine. Run the Keyboard Controller test in Dell Diagnostics . |
| KEYBOARD DATA LINE FAILURE | For external keyboards, check the cable connection. Run the Keyboard Controller test in Dell Diagnostics . |
| KEYBOARD STUCK KEY FAILURE | For external keyboards or keypads, check the cable connection. Restart the computer, and avoid touching the keyboard or keys during the boot routine. Run the Stuck Key test in Dell Diagnostics . |

Table 22. Diagnostic error messages (continued)

| Error messages | Description |
|---|--|
| LICENSED CONTENT IS NOT ACCESSIBLE IN MEDIADIRECT | Dell MediaDirect cannot verify the Digital Rights Management (DRM) restrictions on the file, so the file cannot be played. |
| MEMORY ADDRESS LINE FAILURE AT ADDRESS, READ VALUE EXPECTING VALUE | A memory module may be faulty or improperly seated. Reinstall the memory module or, if necessary, replace it. |
| MEMORY ALLOCATION ERROR | The software you are attempting to run is conflicting with the operating system, another program, or a utility. Shut down the computer, wait for 30 seconds, and then restart it. Run the program again. If the error message still appears, see the software documentation. |
| MEMORY DOUBLE WORD LOGIC FAILURE AT ADDRESS, READ VALUE EXPECTING VALUE | A memory module may be faulty or improperly seated. Reinstall the memory module or, if necessary, replace it. |
| MEMORY ODD/EVEN LOGIC FAILURE AT ADDRESS, READ VALUE EXPECTING VALUE | A memory module may be faulty or improperly seated. Reinstall the memory module or, if necessary, replace it. |
| MEMORY WRITE/READ FAILURE AT ADDRESS, READ VALUE EXPECTING VALUE | A memory module may be faulty or improperly seated. Reinstall the memory module or, if necessary, replace it. |
| NO BOOT DEVICE AVAILABLE | The computer cannot find the hard drive. If the hard drive is your boot device, ensure that the drive is installed, properly seated, and partitioned as a boot device. |
| NO BOOT SECTOR ON HARD DRIVE | The operating system may be corrupted, Contact Dell. |
| NO TIMER TICK INTERRUPT | A chip on the system board may be malfunctioning. Run the System Set tests in Dell Diagnostics . |
| NOT ENOUGH MEMORY OR RESOURCES. EXIT SOME PROGRAMS AND TRY AGAIN | You have too many programs open. Close all windows and open the program that you want to use. |
| OPERATING SYSTEM NOT FOUND | Reinstall the operating system. If the problem persists, Contact Dell. |
| OPTIONAL ROM BAD CHECKSUM | The optional ROM has failed. Contact Dell. |
| SECTOR NOT FOUND | The operating system cannot locate a sector on the hard drive. You may have a defective sector or corrupted File Allocation Table (FAT) on the hard drive. Run the Windows error-checking utility to check the file structure on the hard drive. See Windows Help and Support for instructions (click Start > Help and Support). If a large number of sectors are defective, back up the data (if possible), and then format the hard drive. |
| SEEK ERROR | The operating system cannot find a specific track on the hard drive. |
| SHUTDOWN FAILURE | A chip on the system board may be malfunctioning. Run the System Set tests in Dell Diagnostics . If the message reappears, Contact Dell. |
| TIME-OF-DAY CLOCK LOST POWER | System configuration settings are corrupted. Connect your computer to an electrical outlet to charge the battery. If the problem persists, try to restore the data by entering the System Setup program, then immediately exit the program. If the message reappears, Contact Dell. |
| TIME-OF-DAY CLOCK STOPPED | The reserve battery that supports the system configuration settings may require recharging. Connect your computer to an electrical outlet to charge the battery. If the problem persists, Contact Dell. |

Table 22. Diagnostic error messages (continued)

| Error messages | Description |
|---|--|
| TIME-OF-DAY NOT SET-PLEASE RUN THE SYSTEM SETUP PROGRAM | The time or date stored in the system setup program does not match the system clock. Correct the settings for the Date and Time options. |
| TIMER CHIP COUNTER 2 FAILED | A chip on the system board may be malfunctioning. Run the System Set tests in Dell Diagnostics . |
| UNEXPECTED INTERRUPT IN PROTECTED MODE | The keyboard controller may be malfunctioning, or a memory module may be loose. Run the System Memory tests and the Keyboard Controller test in Dell Diagnostics or Contact Dell . |
| X:\ IS NOT ACCESSIBLE. THE DEVICE IS NOT READY | Insert a disk into the drive and try again. |

System error messages

Table 23. System error messages

| System message | Description |
|---|--|
| Alert! Previous attempts at booting this system have failed at checkpoint [nnnn]. For help in resolving this problem, please note this checkpoint and contact Dell Technical Support | The computer failed to complete the boot routine three consecutive times for the same error. |
| CMOS checksum error | RTC is reset, BIOS Setup default has been loaded. |
| CPU fan failure | CPU fan has failed. |
| System fan failure | System fan has failed. |
| Hard-disk drive failure | Possible hard disk drive failure during POST. |
| Keyboard failure | Keyboard failure or loose cable. If reseating the cable does not solve the problem, replace the keyboard. |
| No boot device available | No bootable partition on hard disk drive, the hard disk drive cable is loose, or no bootable device exists. <ul style="list-style-type: none"> • If the hard drive is your boot device, ensure that the cables are connected and that the drive is installed properly and partitioned as a boot device. • Enter system setup and ensure that the boot sequence information is correct. |
| No timer tick interrupt | A chip on the system board might be malfunctioning or motherboard failure. |
| NOTICE - Hard Drive SELF MONITORING SYSTEM has reported that a parameter has exceeded its normal operating range. Dell recommends that you back up your data regularly. A parameter out of range may or may not indicate a potential hard drive problem | S.M.A.R.T error, possible hard disk drive failure. |

Backup media and recovery options

It is recommended to create a recovery drive to troubleshoot and fix problems that may occur with Windows. Dell proposes multiple options for recovering Windows operating system on your Dell PC. For more information, see [Dell Windows Backup Media and Recovery Options](#).

Wi-Fi power cycle

About this task

If your computer is unable to access the internet due to Wi-Fi connectivity issues, a Wi-Fi power cycle procedure must be performed. The following procedure provides the instructions on how to conduct a WiFi power cycle:

 **NOTE:** Some ISPs (Internet Service Providers) provide a modem/router combo device.

Steps



1. Turn off your computer.
2. Turn off the modem.
3. Turn off the wireless router.
4. Wait for 30 seconds.
5. Turn on the wireless router.
6. Turn on the modem.
7. Turn on your computer.

Getting help and contacting Dell

Self-help resources

You can get information and help on Dell products and services using these self-help resources:

Table 24. Self-help resources

| Self-help resources | Resource location |
|---|--|
| Information about Dell products and services | www.dell.com |
| My Dell app |  |
| Tips |  |
| Contact Support | In Windows search, type <code>Contact Support</code> , and press Enter. |
| Online help for operating system | www.dell.com/support/windows |
| Access top solutions, diagnostics, drivers and downloads, and learn more about your computer through videos, manuals and documents. | Your Dell computer is uniquely identified by a Service Tag or Express Service Code. To view relevant support resources for your Dell computer, enter the Service Tag or Express Service Code at www.dell.com/support . For more information on how to find the Service Tag for your computer, see Locate the Service Tag on your computer . |
| Dell knowledge base articles for a variety of computer concerns | <ol style="list-style-type: none"> 1. Go to www.dell.com/support. 2. On the menu bar at the top of the Support page, select Support > Knowledge Base. 3. In the Search field on the Knowledge Base page, type the keyword, topic, or model number, and then click or tap the search icon to view the related articles. |

Contacting Dell

To contact Dell for sales, technical support, or customer service issues, see www.dell.com/contactdell.

 **NOTE:** Availability varies by country/region and product, and some services may not be available in your country/region.

 **NOTE:** If you do not have an active Internet connection, you can find contact information about your purchase invoice, packing slip, bill, or Dell product catalog.