

Precision 3560

Service Manual



Notes, cautions, and warnings

 **NOTE:** A NOTE indicates important information that helps you make better use of your product.

 **CAUTION:** A CAUTION indicates either potential damage to hardware or loss of data and tells you how to avoid the problem.

 **WARNING:** A WARNING indicates a potential for property damage, personal injury, or death.

| | |
|--|-----------|
| Chapter 1: Working inside your computer | 7 |
| Before working inside your computer..... | 7 |
| Safety precautions..... | 7 |
| Electrostatic discharge—ESD protection..... | 8 |
| ESD field service kit | 8 |
| After working inside your computer..... | 9 |
| | |
| Chapter 2: Major components of your computer | 10 |
| | |
| Chapter 3: Removing and installing components | 13 |
| Recommended tools..... | 13 |
| Screw list..... | 13 |
| Subscriber Identity Module (SIM) card..... | 15 |
| Removing the SIM card..... | 15 |
| Installing the SIM card..... | 16 |
| Micro Secure Digital (SD) Card..... | 17 |
| Removing the microSD card..... | 17 |
| Installing the microSD card..... | 18 |
| Base cover..... | 19 |
| Removing the base cover..... | 19 |
| Installing the base cover..... | 21 |
| WLAN card..... | 23 |
| Removing the WLAN card..... | 23 |
| Installing the WLAN card..... | 24 |
| WWAN card..... | 26 |
| Removing the WWAN card..... | 26 |
| Installing the WWAN card..... | 27 |
| Solid-state drive..... | 28 |
| Removing the M.2 2280 solid-state drive..... | 28 |
| Installing the M.2 2280 solid-state drive..... | 29 |
| Removing the M.2 2230 solid-state drive..... | 29 |
| Installing the M.2 2230 solid-state drive..... | 30 |
| Memory modules..... | 31 |
| Removing the memory modules..... | 31 |
| Installing the memory modules..... | 32 |
| Battery..... | 32 |
| Lithium-ion battery precautions..... | 32 |
| Removing the 3-cell battery..... | 33 |
| Installing the 3-cell battery..... | 34 |
| Removing the 4-cell battery..... | 35 |
| Installing the 4-cell battery..... | 35 |
| Battery cable..... | 36 |
| Removing the battery cable..... | 36 |
| Installing the battery cable..... | 37 |

| | |
|---|----|
| Assembly inner frame..... | 38 |
| Removing the assembly inner frame..... | 38 |
| Installing the assembly inner frame..... | 40 |
| LED board..... | 43 |
| Removing the LED board..... | 43 |
| Installing the LED board..... | 43 |
| System fan..... | 44 |
| Removing the system fan..... | 44 |
| Installing the system fan..... | 45 |
| Heat sink..... | 46 |
| Removing the heat sink (for computers shipped with integrated graphics card)..... | 46 |
| Installing the heat sink (for computers shipped with integrated graphics card)..... | 47 |
| Removing the heat sink (for computers shipped with discrete graphics card)..... | 48 |
| Installing the heat sink (for computers shipped with discrete graphics card)..... | 49 |
| Speakers..... | 50 |
| Removing the speaker..... | 50 |
| Installing the speaker..... | 51 |
| System board..... | 52 |
| Removing the system board..... | 52 |
| Installing the system board..... | 54 |
| Power-button board..... | 56 |
| Removing the power-button board..... | 56 |
| Installing the power-button board..... | 57 |
| Smart card reader..... | 58 |
| Removing the smart card reader..... | 58 |
| Installing the smart card reader..... | 59 |
| Keyboard assembly..... | 61 |
| Removing the keyboard assembly..... | 61 |
| Installing the keyboard assembly..... | 62 |
| Keyboard bracket..... | 64 |
| Removing the keyboard bracket..... | 64 |
| Installing the keyboard bracket..... | 64 |
| Display assembly..... | 65 |
| Removing the display assembly..... | 65 |
| Installing the display assembly..... | 68 |
| Display bezel..... | 70 |
| Removing the display bezel..... | 70 |
| Installing the display bezel..... | 71 |
| Display panel..... | 72 |
| Removing the display panel..... | 72 |
| Installing the display panel..... | 74 |
| Camera/microphone module..... | 77 |
| Removing the camera/microphone module..... | 77 |
| Installing the camera/microphone module..... | 77 |
| eDP/display cable..... | 78 |
| Removing the eDP/display cable..... | 78 |
| Installing the eDP/display cable..... | 79 |
| Sensor board..... | 80 |
| Removing the sensor board..... | 80 |
| Installing the sensor board..... | 81 |

| | |
|---|------------|
| Display hinges..... | 82 |
| Removing the display hinges..... | 82 |
| Installing the display hinges..... | 83 |
| Display back cover..... | 85 |
| Removing the display back cover..... | 85 |
| Installing the display back cover..... | 85 |
| Dummy SIM-card slot filler..... | 86 |
| Removing the dummy SIM-card slot filler..... | 86 |
| Installing the dummy SIM-card slot filler..... | 87 |
| Palm-rest assembly..... | 88 |
| Removing the palm-rest assembly..... | 88 |
| Installing the palm-rest assembly..... | 89 |
| Chapter 4: Software..... | 91 |
| Operating system..... | 91 |
| Downloading the drivers..... | 91 |
| Chapter 5: System setup..... | 92 |
| BIOS overview..... | 92 |
| Entering BIOS setup program..... | 92 |
| Navigation keys..... | 92 |
| One time boot menu..... | 93 |
| Boot Sequence..... | 93 |
| System setup options..... | 93 |
| Updating the BIOS..... | 103 |
| Updating the BIOS in Windows..... | 103 |
| Updating the BIOS in Linux and Ubuntu..... | 104 |
| Updating the BIOS using the USB drive in Windows..... | 104 |
| Updating the BIOS from the F12 One-Time boot menu..... | 104 |
| System and setup password..... | 105 |
| Assigning a system setup password..... | 105 |
| Deleting or changing an existing system setup password..... | 106 |
| Clearing BIOS (System Setup) and System passwords..... | 106 |
| Chapter 6: Troubleshooting..... | 107 |
| Handling swollen Lithium-ion batteries..... | 107 |
| Dell SupportAssist Pre-boot System Performance Check diagnostics..... | 108 |
| Running the SupportAssist Pre-Boot System Performance Check..... | 108 |
| Built-in self-test (BIST)..... | 108 |
| M-BIST..... | 108 |
| LCD Power rail test (L-BIST)..... | 109 |
| LCD Built-in Self Test (BIST)..... | 109 |
| System diagnostic lights..... | 110 |
| Recovering the operating system..... | 111 |
| Real-Time Clock (RTC Reset)..... | 111 |
| Backup media and recovery options..... | 111 |
| WiFi power cycle..... | 112 |
| Drain residual flea power (perform hard reset)..... | 112 |

Chapter 7: Getting help and contacting Dell..... 113

Working inside your computer

Topics:

- [Before working inside your computer](#)
- [Safety precautions](#)
- [Electrostatic discharge—ESD protection](#)
- [ESD field service kit](#)
- [After working inside your computer](#)

Before working inside your computer

About this task

 **NOTE:** The images in this document may differ from your computer depending on the configuration you ordered.

Steps

1. Save and close all open files and exit all open applications.

2. Shut down your computer. Click **Start** >  **Power** > **Shut down**.

 **NOTE:** If you are using a different operating system, see the documentation of your operating system for shut-down instructions.

3. Disconnect your computer and all attached devices from their electrical outlets.

4. Disconnect all attached network devices and peripherals, such as keyboard, mouse, and monitor from your computer.

 **CAUTION:** To disconnect a network cable, first unplug the cable from your computer and then unplug the cable from the network device.

5. Remove any media card and optical disc from your computer, if applicable.

Safety precautions

The safety precautions chapter details the primary steps to be taken before performing any disassembly instructions.

Observe the following safety precautions before you perform any installation or break/fix procedures involving disassembly or reassembly:

- Turn off the system and all attached peripherals.
- Disconnect the system and all attached peripherals from AC power.
- Disconnect all network cables, telephone, and telecommunications lines from the system.
- Use an ESD field service kit when working inside any notebook to avoid electrostatic discharge (ESD) damage.
- After removing any system component, carefully place the removed component on an anti-static mat.
- Wear shoes with non-conductive rubber soles to reduce the chance of getting electrocuted.

Standby power

Dell products with standby power must be unplugged before you open the case. Systems that incorporate standby power are essentially powered while turned off. The internal power enables the system to be remotely turned on (wake on LAN) and suspended into a sleep mode and has other advanced power management features.

Unplugging, pressing and holding the power button for 15 seconds should discharge residual power in the system board. Remove the battery from notebooks.

Bonding

Bonding is a method for connecting two or more grounding conductors to the same electrical potential. This is done through the use of a field service electrostatic discharge (ESD) kit. When connecting a bonding wire, ensure that it is connected to bare metal and never to a painted or non-metal surface. The wrist strap should be secure and in full contact with your skin, and ensure that you remove all jewelry such as watches, bracelets, or rings prior to bonding yourself and the equipment.

Electrostatic discharge—ESD protection

ESD is a major concern when you handle electronic components, especially sensitive components such as expansion cards, processors, memory DIMMs, and system boards. Very slight charges can damage circuits in ways that may not be obvious, such as intermittent problems or a shortened product life span. As the industry pushes for lower power requirements and increased density, ESD protection is an increasing concern.

Due to the increased density of semiconductors used in recent Dell products, the sensitivity to static damage is now higher than in previous Dell products. For this reason, some previously approved methods of handling parts are no longer applicable.

Two recognized types of ESD damage are catastrophic and intermittent failures.

- **Catastrophic** – Catastrophic failures represent approximately 20 percent of ESD-related failures. The damage causes an immediate and complete loss of device functionality. An example of catastrophic failure is a memory DIMM that has received a static shock and immediately generates a "No POST/No Video" symptom with a beep code emitted for missing or nonfunctional memory.
- **Intermittent** – Intermittent failures represent approximately 80 percent of ESD-related failures. The high rate of intermittent failures means that most of the time when damage occurs, it is not immediately recognizable. The DIMM receives a static shock, but the tracing is merely weakened and does not immediately produce outward symptoms related to the damage. The weakened trace may take weeks or months to melt, and in the meantime may cause degradation of memory integrity, intermittent memory errors, etc.

The more difficult type of damage to recognize and troubleshoot is the intermittent (also called latent or "walking wounded") failure.

Perform the following steps to prevent ESD damage:

- Use a wired ESD wrist strap that is properly grounded. The use of wireless anti-static straps is no longer allowed; they do not provide adequate protection. Touching the chassis before handling parts does not ensure adequate ESD protection on parts with increased sensitivity to ESD damage.
- Handle all static-sensitive components in a static-safe area. If possible, use anti-static floor pads and workbench pads.
- When unpacking a static-sensitive component from its shipping carton, do not remove the component from the anti-static packing material until you are ready to install the component. Before unwrapping the anti-static packaging, ensure that you discharge static electricity from your body.
- Before transporting a static-sensitive component, place it in an anti-static container or packaging.

ESD field service kit

The unmonitored Field Service kit is the most commonly used service kit. Each Field Service kit includes three main components: anti-static mat, wrist strap, and bonding wire.

Components of an ESD field service kit

The components of an ESD field service kit are:

- **Anti-Static Mat** – The anti-static mat is dissipative and parts can be placed on it during service procedures. When using an anti-static mat, your wrist strap should be snug and the bonding wire should be connected to the mat and to any bare metal on the system being worked on. Once deployed properly, service parts can be removed from the ESD bag and placed directly on the mat. ESD-sensitive items are safe in your hand, on the ESD mat, in the system, or inside a bag.
- **Wrist Strap and Bonding Wire** – The wrist strap and bonding wire can be either directly connected between your wrist and bare metal on the hardware if the ESD mat is not required, or connected to the anti-static mat to protect hardware that is temporarily placed on the mat. The physical connection of the wrist strap and bonding wire between your skin, the ESD

mat, and the hardware is known as bonding. Use only Field Service kits with a wrist strap, mat, and bonding wire. Never use wireless wrist straps. Always be aware that the internal wires of a wrist strap are prone to damage from normal wear and tear, and must be checked regularly with a wrist strap tester in order to avoid accidental ESD hardware damage. It is recommended to test the wrist strap and bonding wire at least once per week.

- **ESD Wrist Strap Tester** – The wires inside of an ESD strap are prone to damage over time. When using an unmonitored kit, it is a best practice to regularly test the strap prior to each service call, and at a minimum, test once per week. A wrist strap tester is the best method for doing this test. If you do not have your own wrist strap tester, check with your regional office to find out if they have one. To perform the test, plug the wrist-strap's bonding-wire into the tester while it is strapped to your wrist and push the button to test. A green LED is lit if the test is successful; a red LED is lit and an alarm sounds if the test fails.
- **Insulator Elements** – It is critical to keep ESD sensitive devices, such as plastic heat sink casings, away from internal parts that are insulators and often highly charged.
- **Working Environment** – Before deploying the ESD Field Service kit, assess the situation at the customer location. For example, deploying the kit for a server environment is different than for a desktop or portable environment. Servers are typically installed in a rack within a data center; desktops or portables are typically placed on office desks or cubicles. Always look for a large open flat work area that is free of clutter and large enough to deploy the ESD kit with additional space to accommodate the type of system that is being repaired. The workspace should also be free of insulators that can cause an ESD event. On the work area, insulators such as Styrofoam and other plastics should always be moved at least 12 inches or 30 centimeters away from sensitive parts before physically handling any hardware components.
- **ESD Packaging** – All ESD-sensitive devices must be shipped and received in static-safe packaging. Metal, static-shielded bags are preferred. However, you should always return the damaged part using the same ESD bag and packaging that the new part arrived in. The ESD bag should be folded over and taped shut and all the same foam packing material should be used in the original box that the new part arrived in. ESD-sensitive devices should be removed from packaging only at an ESD-protected work surface, and parts should never be placed on top of the ESD bag because only the inside of the bag is shielded. Always place parts in your hand, on the ESD mat, in the system, or inside an anti-static bag.
- **Transporting Sensitive Components** – When transporting ESD sensitive components such as replacement parts or parts to be returned to Dell, it is critical to place these parts in anti-static bags for safe transport.

ESD protection summary

It is recommended that all field service technicians use the traditional wired ESD grounding wrist strap and protective anti-static mat at all times when servicing Dell products. In addition, it is critical that technicians keep sensitive parts separate from all insulator parts while performing service and that they use anti-static bags for transporting sensitive components.

After working inside your computer

About this task

 **CAUTION:** Leaving stray or loose screws inside your computer may severely damage your computer.

Steps

1. Replace all screws and ensure that no stray screws remain inside your computer.
2. Connect any external devices, peripherals, or cables you removed before working on your computer.
3. Replace any media cards, discs, or any other parts that you removed before working on your computer.
4. Connect your computer and all attached devices to their electrical outlets.
5. Turn on your computer.

Major components of your computer

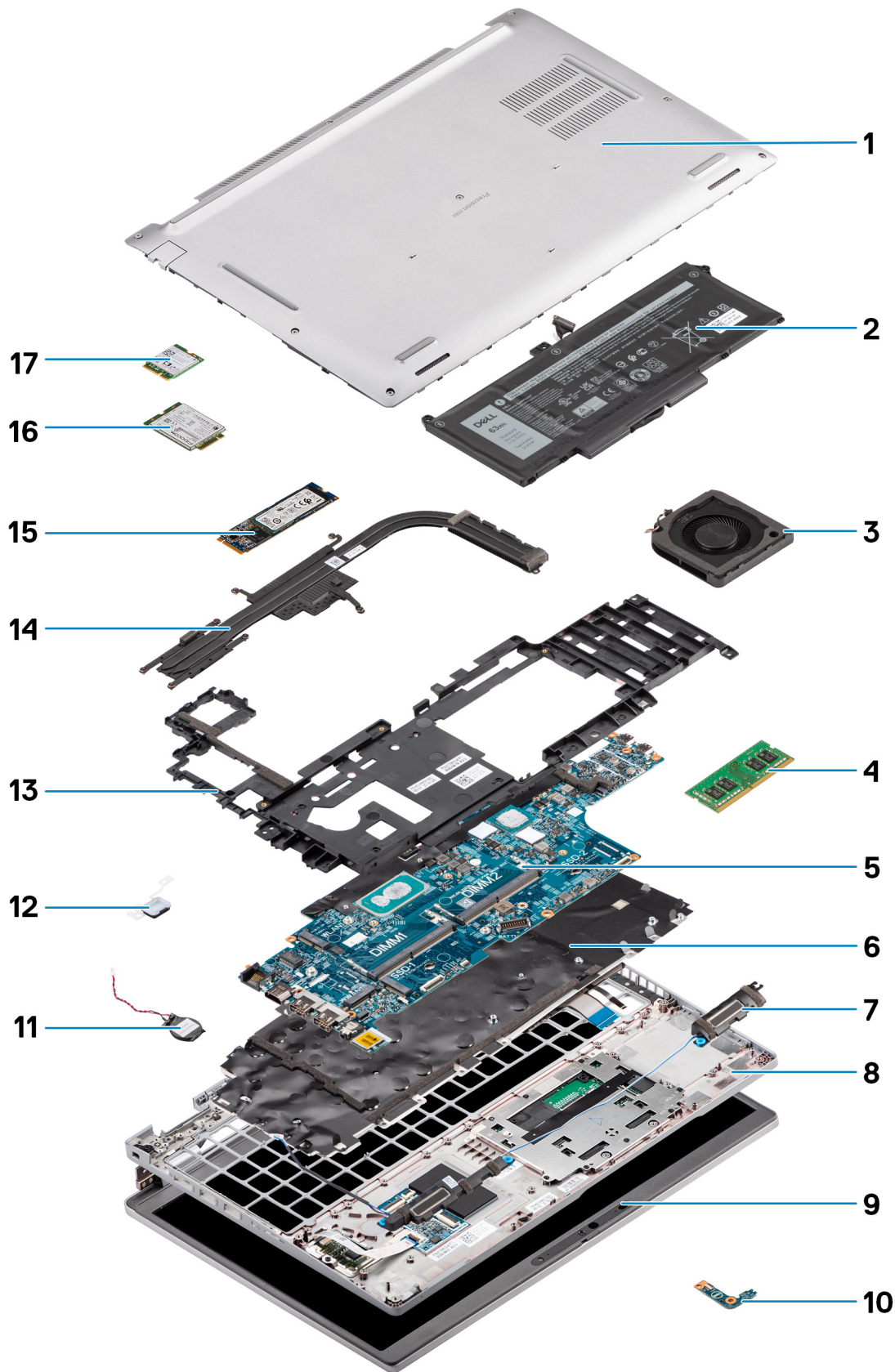

1. Base cover
2. Battery
3. System Fan
4. Memory module
5. System board
6. Keyboard assembly
7. Speakers
8. Palm-rest assembly
9. Display assembly
10. Battery LED board
11. Coin-cell battery
12. Power button/fingerprint board
13. Assembly inner frame
14. Heat sink
15. Solid-state drive
16. WWAN card
17. WLAN card

Removing and installing components

NOTE: The images in this document may differ from your computer depending on the configuration you ordered.

Topics:

- Recommended tools
- Screw list
- Subscriber Identity Module (SIM) card
- Micro Secure Digital (SD) Card
- Base cover
- WLAN card
- WWAN card
- Solid-state drive
- Memory modules
- Battery
- Battery cable
- Assembly inner frame
- LED board
- System fan
- Heat sink
- Speakers
- System board
- Power-button board
- Smart card reader
- Keyboard assembly
- Keyboard bracket
- Display assembly
- Display bezel
- Display panel
- Camera/microphone module
- eDP/display cable
- Sensor board
- Display hinges
- Display back cover
- Dummy SIM-card slot filler
- Palm-rest assembly

Recommended tools

The procedures in this document may require the following tools:

- Phillips screwdriver #0
- Plastic scribe

Screw list

NOTE: When removing screws from a component, it is recommended to note the screw type, the quantity of screws, and then place them in a screw storage box. This is to ensure that the correct number of screws and correct screw type is restored when the component is replaced.

NOTE: Some systems have magnetic surfaces. Ensure that the screws are not left attached to such surface when replacing a component.

NOTE: Screw color may vary with the configuration ordered.

Table 1. Precision 3560 screw list















| Component | Screw type | Quantity | Screw image |
|----------------------------|--|--------------------------------|---|
| Base cover | Captive screws | 8 | |
| WLAN card bracket | Captive screw | 1 | |
| WWAN card bracket | Captive screw | 1 | |
| M.2 2230 solid-state drive | M2x4 | 1 |  |
| M.2 2280 solid-state drive | M2x4 | 1 |  |
| Assembly inner frame | M2x3 | 12 |  |
| 3-cell battery | M2x4 | 2 |  |
| 4-cell battery | M2x4 | 3 |  |
| System Fan | M2x3 | 2 |  |
| Heat sink—integrated | M2x3 Captive screws | 1 - M2x3 4 - captive screws |  |
| Heat sink—discrete | M2x3 Captive screws | 1 - M2x3 7 - captive screws |  |
| eDP cable/bracket | M2x3 | 2 |  |
| USB Type-C support bracket | M2x4 | 3 |  |
| System board | M2x3 | 3 |  |
| Power button | M2x2 | 2 |  |
| Smart card reader | M2x3 | 2 |  |
| LED board | M2x3 | 1 |  |
| Keyboard assembly | M2x2 | 26 |  |
| Keyboard bracket | M2x2 | 10 |  |
| Display assembly | M2.5x5 (display hinge to palm-rest assembly) | 6 |  |

Table 1. Precision 3560 screw list (continued)

| Component | Screw type | Quantity | Screw image |
|---------------|--|----------|---|
| Display hinge | M2.5x3.5 (display hinge to display back cover) | 4 |  |
| Display panel | M2.5x3.5 | 4 |  |

Subscriber Identity Module (SIM) card

Removing the SIM card

Prerequisites

1. Follow the procedure in [Before working inside your computer](#).

 **NOTE:** SIM card or SIM card tray removal is only available on systems that are shipped with WWAN module. The procedure for removal is only applicable for systems that are shipped with a WWAN module.

 **CAUTION:** Removing the SIM card with the computer turned on, may cause data loss or damage to the card. Ensure that your computer is turned off or the network connections are disabled.

About this task

The following images indicate the location of the SIM card and provide a visual representation of the removal procedure.

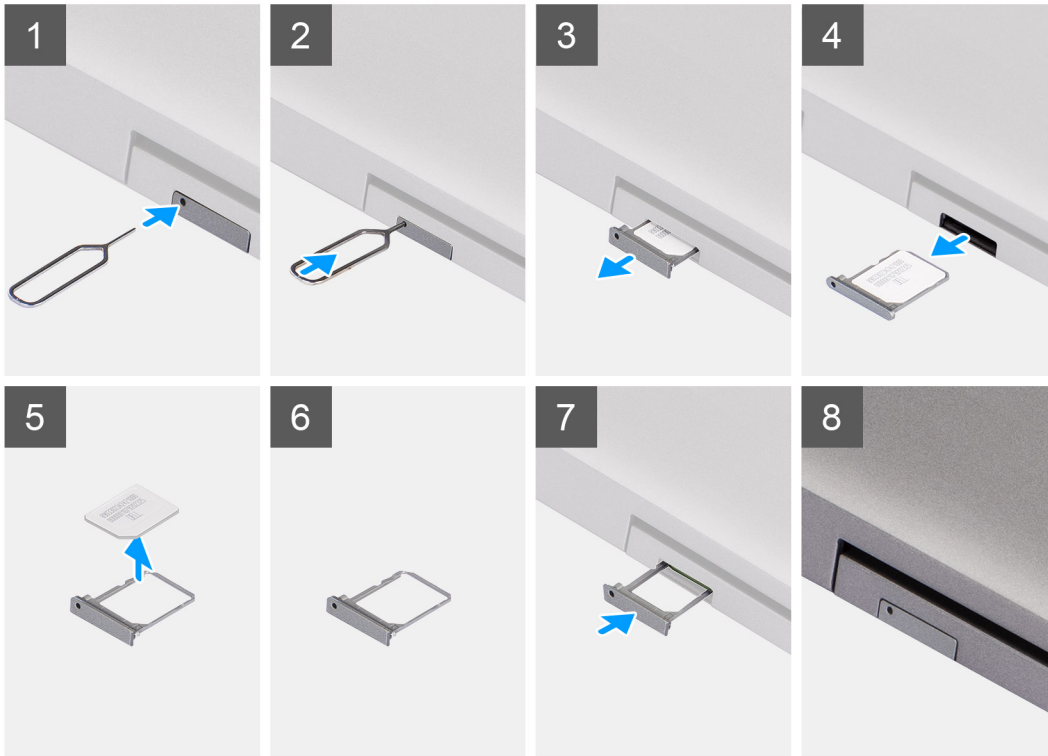

Steps

1. Insert a pin into the hole of the SIM card tray and push inward until the tray is released
2. Slide the SIM card tray out of the slot on the computer.
3. Remove the SIM card from the SIM card tray.
4. Slide the SIM card tray into the slot, until it clicks into place.

Installing the SIM card

Prerequisites

If you are replacing a component, remove the existing component before performing the installation procedure.

i **NOTE:** SIM card or SIM card tray removal is only available on systems that are shipped with WWAN module. Hence, removing procedure is only applicable for systems that are shipped with WWAN module.

About this task

The following image indicates the location of the SIM card and provides a visual representation of the installation procedure.

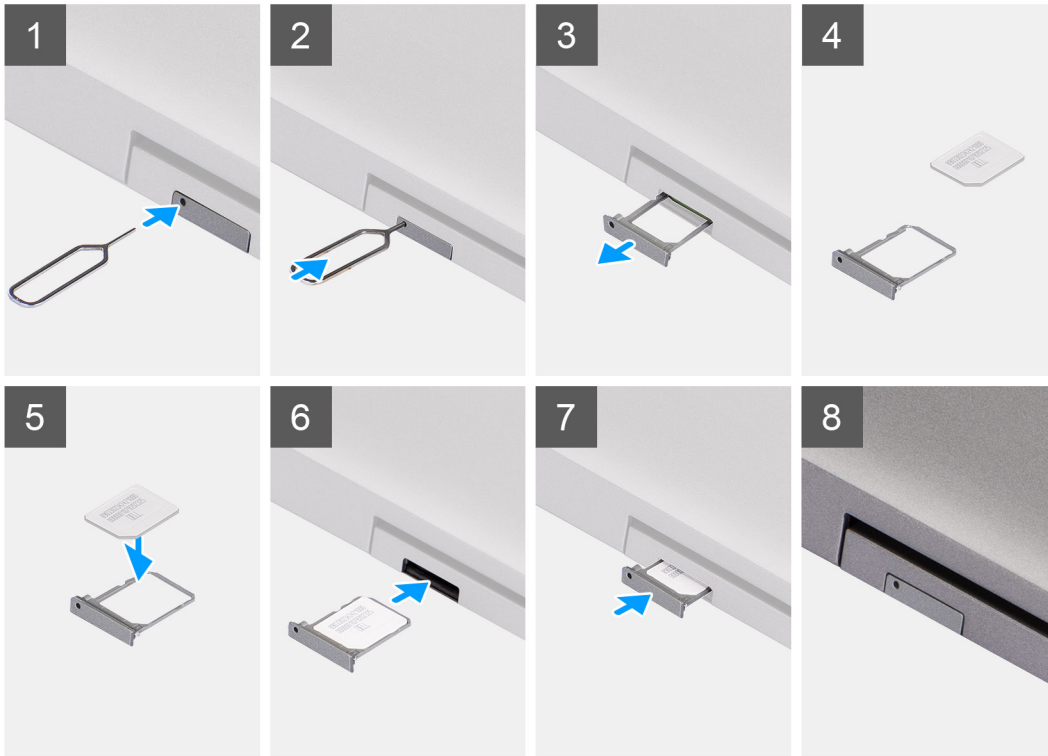

Steps

1. Insert a pin into the hole of the SIM card tray and push inward until the tray is released
2. Slide the SIM card tray out of the slot on the computer.
3. Place the SIM card into the SIM card tray with the metallic contact facing up.
4. Align the SIM card tray with the slot on the computer and carefully slide it in.
5. Slide the SIM card tray into the slot, until it clicks into place.

Next steps

1. Follow the procedure in [After working inside your computer](#).

Micro Secure Digital (SD) Card

Removing the microSD card

Prerequisites

1. Follow the procedure in [Before working inside your computer](#).

About this task

The following images indicate the location of the microSD card and provide a visual representation of the removal procedure.



Steps

1. Push the microSD card to release it from the computer.
2. Slide the microSD card out of the computer.

Installing the microSD card

About this task

The following image indicates the location of the microSD card and provides a visual representation of the installation procedure.

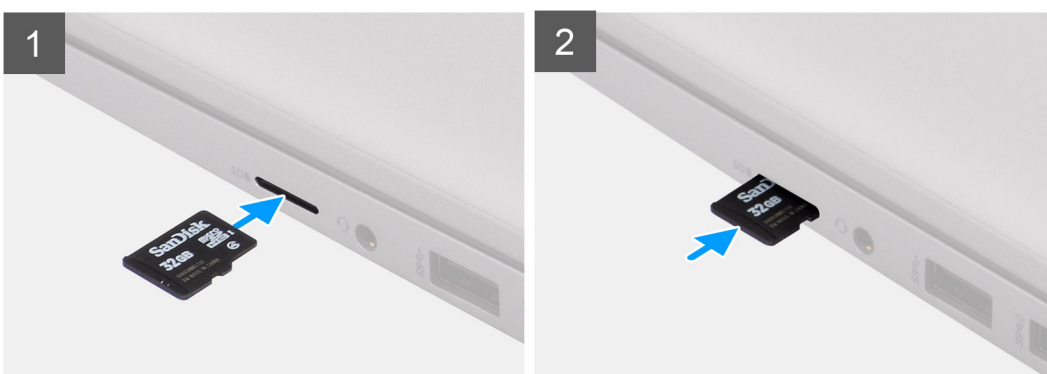

Steps

1. Align the microSD card to its slot on the computer.
2. Slide the microSD card into the slot until it clicks into place.

Next steps

Follow the procedures in [After working inside your computer](#).

Base cover

Removing the base cover

Prerequisites

1. Follow the procedure in [Before working inside your computer](#).
2. Remove the [SIM card](#).
3. Remove the [microSD card](#).

About this task

The following images indicate the location of the base cover and provide a visual representation of the removal procedure.



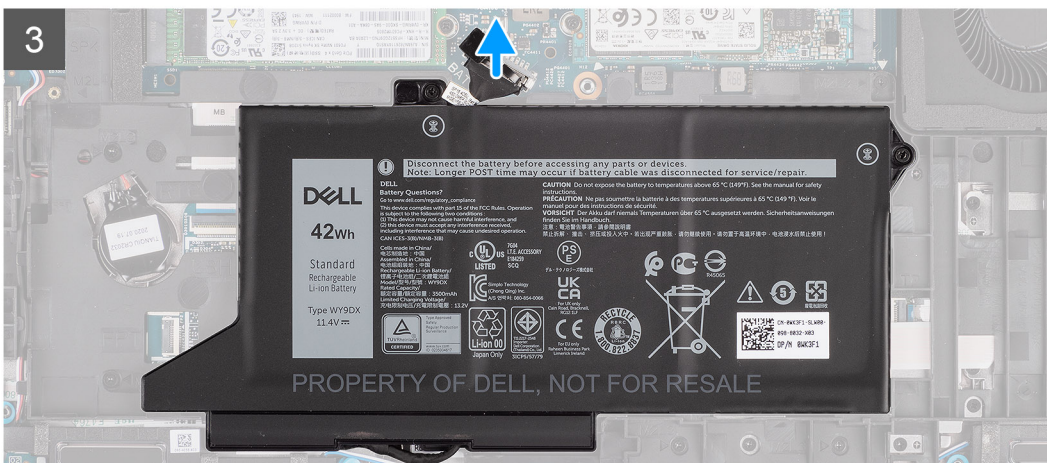
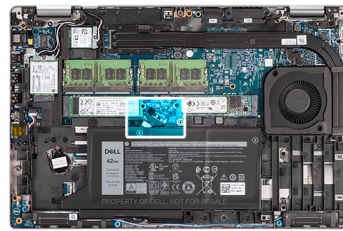
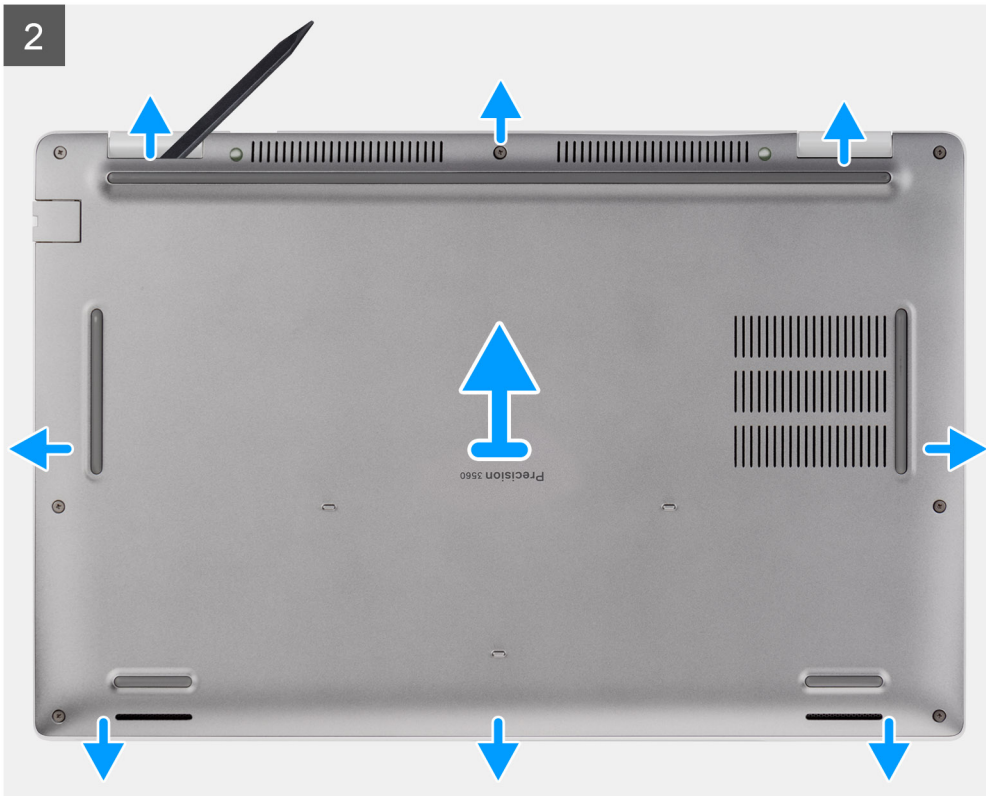



Steps

1. Loosen the eight captive screws that secure the base cover to the palm-rest assembly and keyboard assembly.
2. Using a plastic scribe, pry the base cover from the U-shaped indents at the top edge of the base cover to remove the base cover from the palm-rest assembly and keyboard assembly.
3. Grasp the left side and the right side of the base cover and remove the base cover from the palm-rest assembly and keyboard assembly.

i NOTE: Disconnecting the battery cable, removing the battery, or draining the flea power clears the CMOS and resets the BIOS settings on your computer.

i NOTE: After your computer is reassembled and powered on, it prompts for the Real Time Clock (RTC) reset. When the RTC reset cycle occurs, the computer restarts several times and then an error message is displayed– "Time of day not set". Enter the BIOS when this error appears and set the date and time on your computer to resume normal functionality.

4. Disconnect the battery cable from the system board.
5. Turn your computer over and press the power button for 15 seconds to drain the flea power.

Installing the base cover

Prerequisites

If you are replacing a component, remove the existing component before performing the installation procedure.

About this task

The following images indicate the location of the base cover and provide a visual representation of the installation procedure.

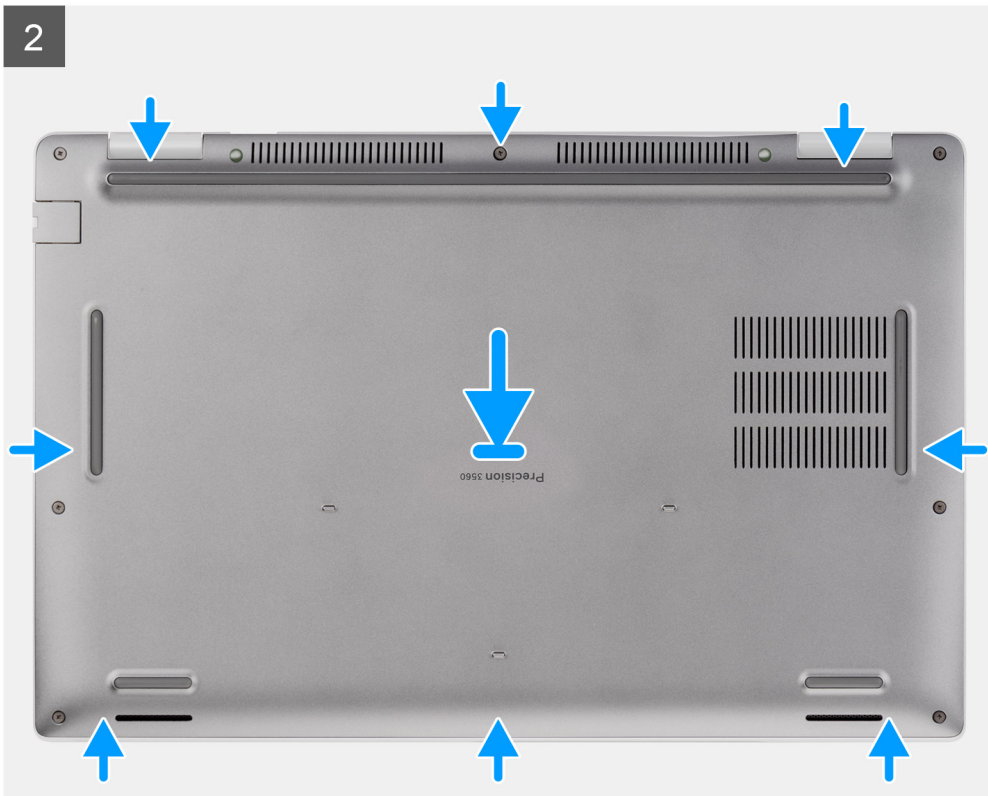
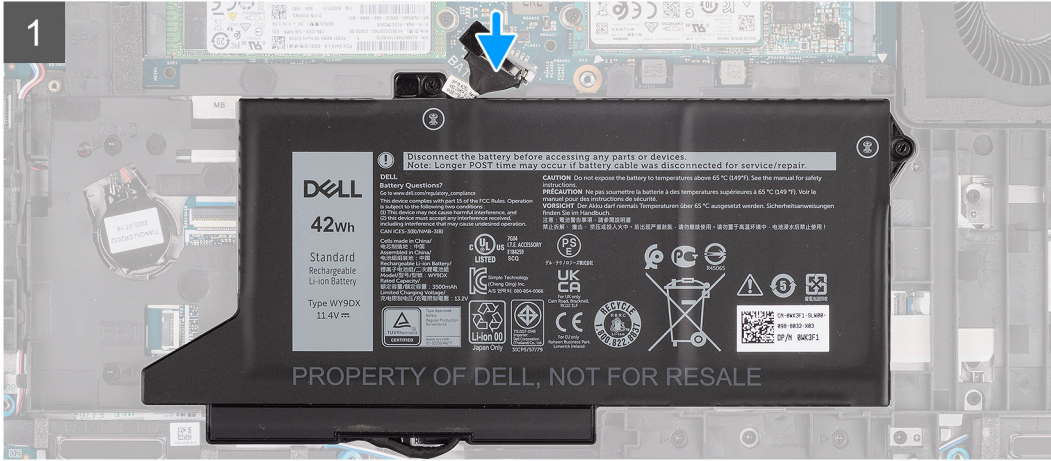
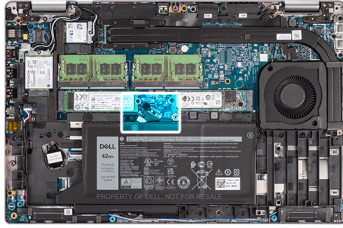



Steps

1. Connect the battery cable to the system board.
2. Align the screw holes on the base cover with the screw holes on the palm-rest assembly and keyboard assembly, and then snap the base cover into place.
3. Tighten the eight captive screws that secure the base cover to the palm-rest assembly and keyboard assembly.

Next steps

1. Install the [microSD card](#).
2. Install the [SIM card](#).
3. Follow the procedure in [After working inside your computer](#).

WLAN card

Removing the WLAN card

Prerequisites

1. Follow the procedure in [Before working inside your computer](#).
2. Remove the [SIM card](#).
3. Remove the [microSD card](#).
4. Remove the [base cover](#).

About this task

The following images indicate the location of the WLAN card and provide a visual representation of the removal procedure.

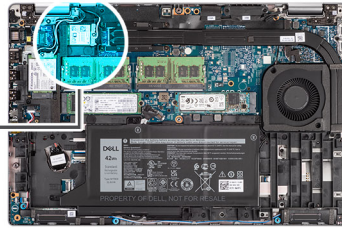

Steps

i **NOTE:** When removing the WLAN card from the system, if the adhesive pad which helps secure the WLAN card in place is removed from the system along with the WLAN card, adhere it back to the system.

1. Loosen the single captive screw that secures the WLAN card bracket to the WLAN card.
2. Slide and remove the WLAN card bracket off the WLAN card.
3. Disconnect the antenna cables from the WLAN card.
4. Slide and remove the WLAN card from the WLAN card slot.

Installing the WLAN card

Prerequisites

If you are replacing a component, remove the existing component before performing the installation procedure.

About this task

The following image indicates the location of the WLAN card and provides a visual representation of the installation procedure.

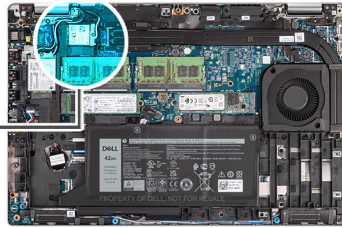

Steps

1. Connect the antenna cables to the wireless card.
The following table provides the antenna-cable color scheme:

Table 2. Antenna-cable color scheme

| Connectors on the wireless card | Antenna-cable color |
|---------------------------------|---------------------|
| Main (white triangle) | White |
| Auxiliary (black triangle) | Black |

2. Place the wireless-card bracket on the wireless card.
3. Align the notch on the wireless card with the tab on the wireless-card slot.
4. Slide the wireless card at an angle into the wireless-card slot.
5. Tighten the single captive screw to secure the wireless-card bracket to the wireless card.

Next steps

1. Install the [base cover](#).
2. Install the [microSD card](#).
3. Install the [SIM card](#).
4. Follow the procedure in [After working inside your computer](#).

WWAN card

Removing the WWAN card

Prerequisites

1. Follow the procedure in [Before working inside your computer](#).
2. Remove the [SIM card](#).
3. Remove the [microSD card](#).
4. Remove the [base cover](#).

About this task

The following image indicates the location of the WWAN card and provide a visual representation of the removal procedure.

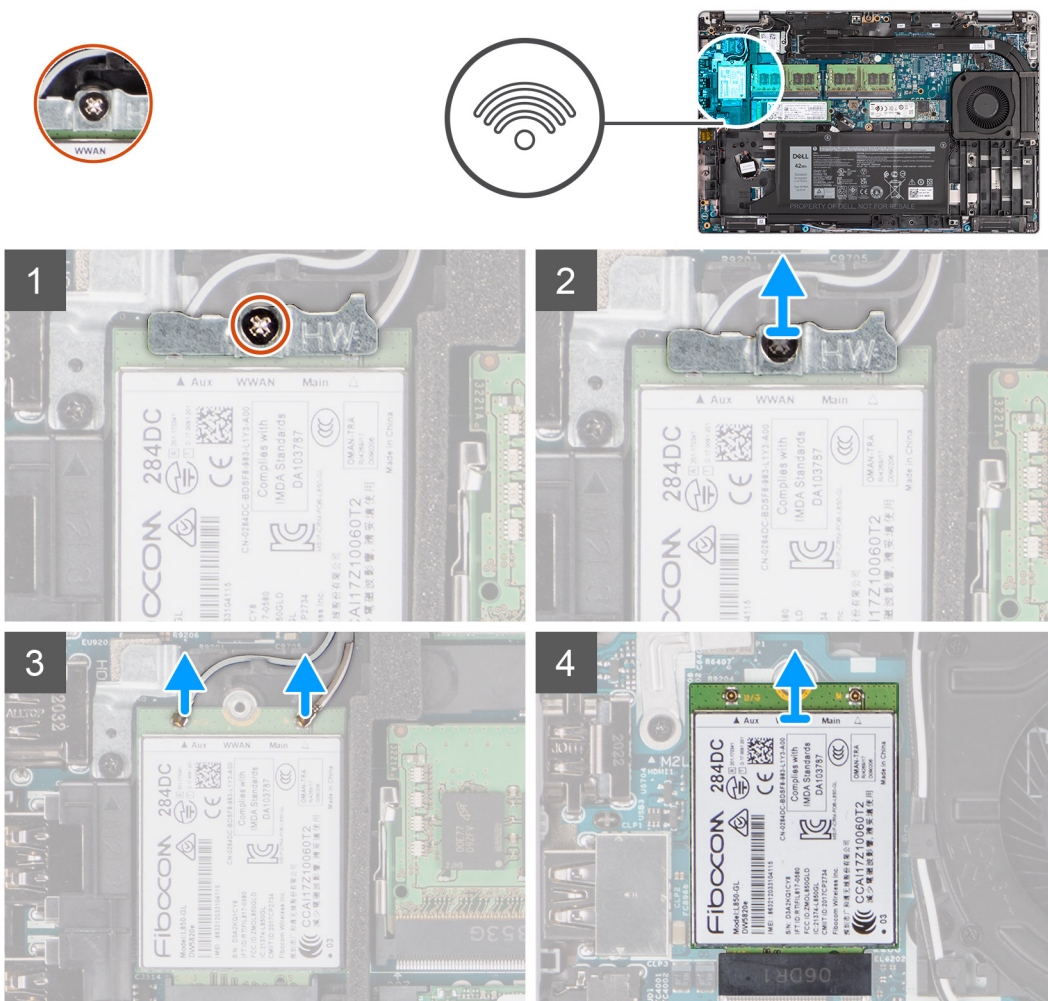

Steps

1. Loosen the single captive screw that secures the WWAN card bracket to the WWAN card.
2. Slide and remove the WWAN card bracket off the WWAN card.
3. Disconnect the antenna cables from the WWAN card.
4. Slide and remove the WWAN card from the WWAN card slot.

Installing the WWAN card

Prerequisites

If you are replacing a component, remove the existing component before performing the installation procedure.

About this task

The following image indicates the location of the WWAN card and provides a visual representation of the installation procedure.

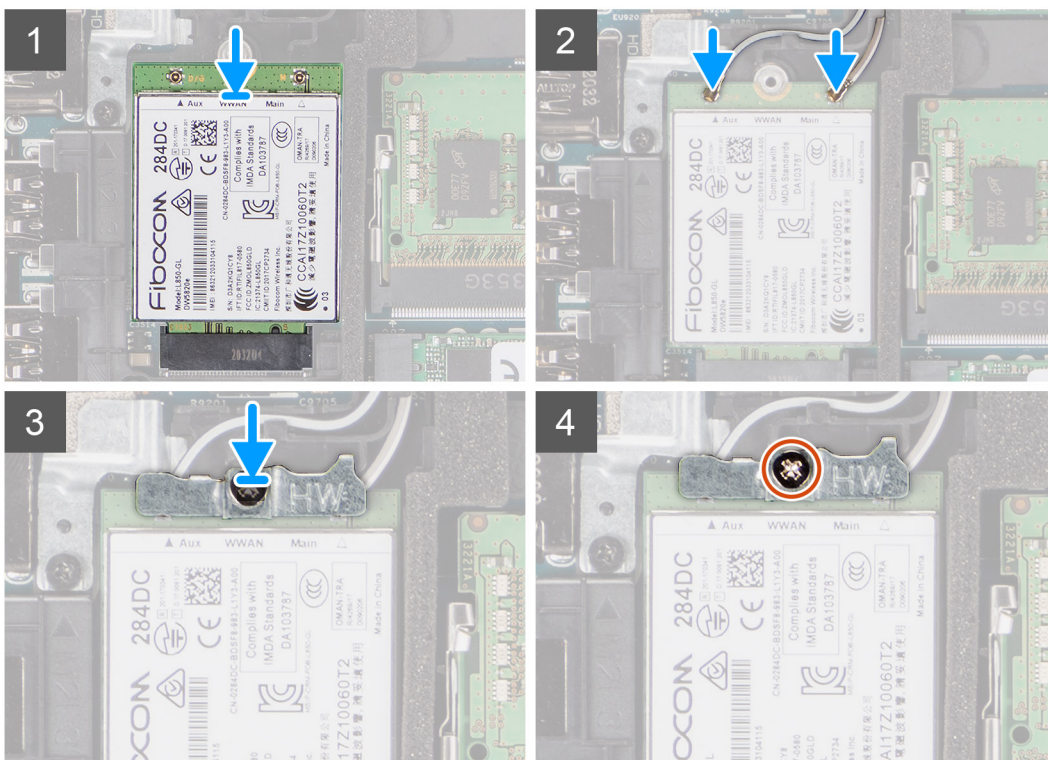
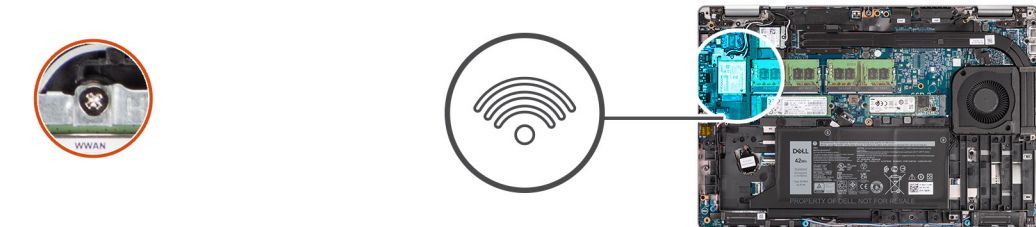

Steps

1. Connect the antenna cables to the WWAN card.

The following table provides the antenna-cable color scheme:

Table 3. Antenna-cable color scheme

| Connectors on the WWAN card | Antenna-cable color |
|-----------------------------|---------------------|
| Main (white triangle) | White |
| Auxiliary (black triangle) | Black |

2. Place the WWAN card bracket on the WWAN card.
3. Align the notch on the WWAN card with the tab on the WWAN slot.
4. Slide the WWAN card at an angle into the WWAN slot.
5. Tighten the single captive screw to secure the WWAN bracket to the WWAN card.

NOTE: For instructions on how to find your computer's IMEI (International Mobile Station Equipment Identity) number, see the knowledge base article [000143678](https://www.dell.com/support/000143678) at www.dell.com/support.

Next steps

1. Install the [base cover](#).
2. Install the [microSD card](#).
3. Install the [SIM card](#).
4. Follow the procedure in [After working inside your computer](#).

Solid-state drive

Removing the M.2 2280 solid-state drive

Prerequisites

1. Follow the procedure in [Before working inside your computer](#).
2. Remove the [SIM card](#).
3. Remove the [microSD card](#).
4. Remove the [base cover](#).

About this task

NOTE: You can refer the below procedure to remove the M.2 2280 solid-state drive removal from SLOT 1 and SLOT 2.

The following images indicate the location of the M.2 2280 solid-state drive and provide a visual representation of the removal procedure.

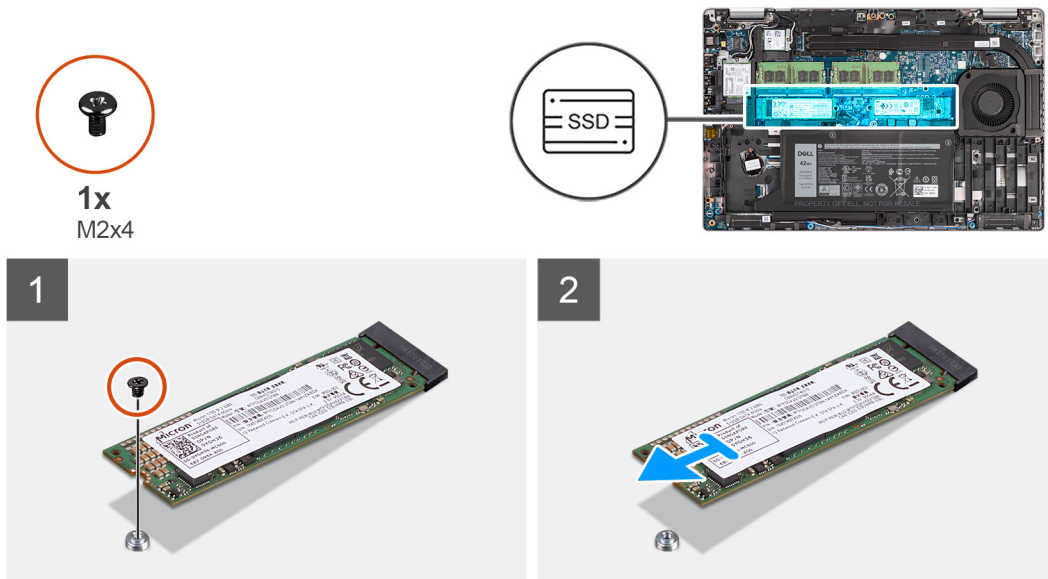

Steps

1. Remove the single screw (M2x4) that secures the M.2 2280 solid-state drive to the system board.
2. Slide and remove the M.2 2280 solid-state drive from the solid-state drive slot on the system board.

Installing the M.2 2280 solid-state drive

Prerequisites

If you are replacing a component, remove the existing component before performing the installation procedure.

About this task

NOTE: Slot 2 can only support M.2 Gen 4 PCIe x4 NVMe solid-state drive. You can refer the below procedure to install the M.2 2280 solid-state drive in both SLOT 1 and SLOT 2.

The following image indicates the location of the M.2 2280 solid-state drive and provides a visual representation of the installation procedure.

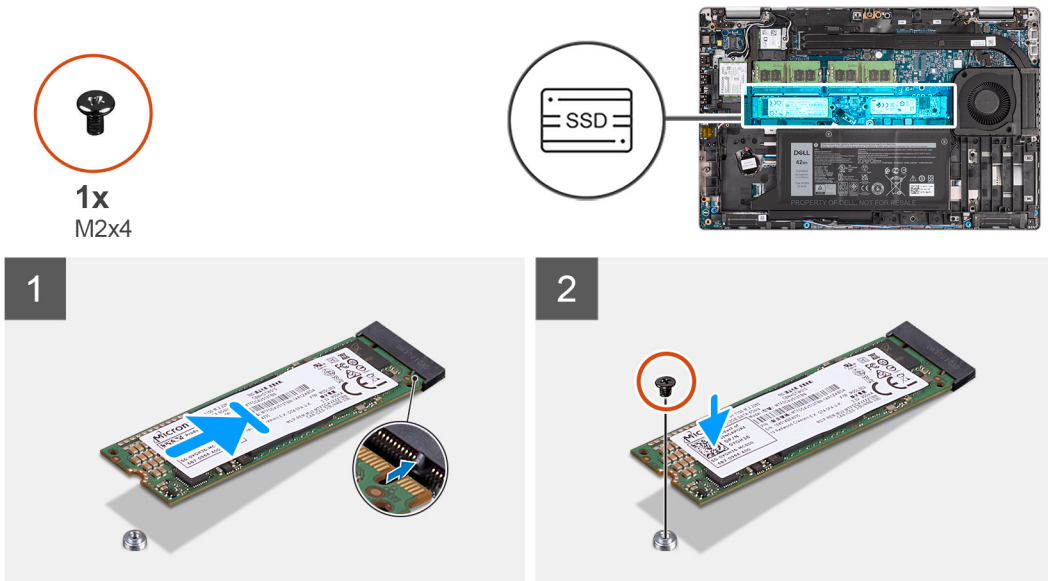

Steps

1. Remove the solid-state drive holder from the system board if required.
2. Align the notch on the solid-state drive with the tab on the solid-state drive slot.
3. Slide the M.2 2280 solid-state drive into the solid-state drive slot on the system board.
4. Replace the screw (M2x4) that secures the M.2 2280 solid-state drive to the system board.

Next steps

1. Install the [base cover](#).
2. Install the [microSD card](#).
3. Install the [SIM card](#).
4. Follow the procedure in [After working inside your computer](#).

Removing the M.2 2230 solid-state drive

Prerequisites

1. Follow the procedure in [Before working inside your computer](#).
2. Remove the [SIM card](#).
3. Remove the [microSD card](#).
4. Remove the [base cover](#).

About this task

The following images indicate the location of the M.2 2230 solid-state drive and provide a visual representation of the removal procedure.

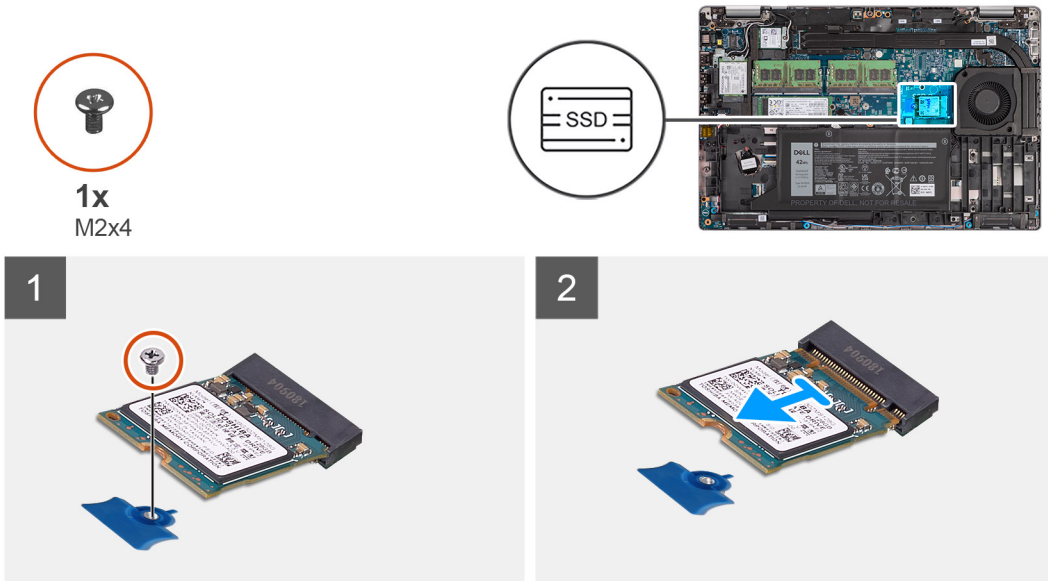

Steps

1. Remove the single screw (M2x4) that secures the M.2 2230 solid-state drive to the system board.
2. Slide and remove the M.2 2230 solid-state drive from the solid-state drive slot on the system board.

Installing the M.2 2230 solid-state drive

Prerequisites

If you are replacing a component, remove the existing component before performing the installation procedure.

About this task

The following image indicates the location of the M.2 2230 solid-state drive and provides a visual representation of the installation procedure.

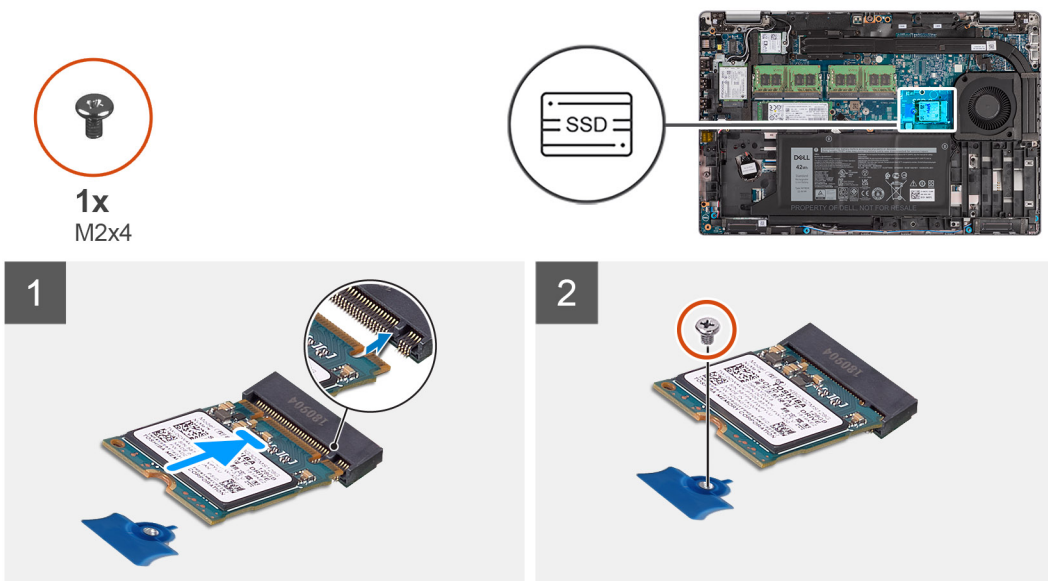

Steps

1. Align the notch on the solid-state drive with the tab on the solid-state drive slot.
2. Slide the M.2 2230 solid-state drive into the solid-state drive slot on the system board.
3. Replace the screw (M2x4) that secures the M.2 2230 solid-state drive to the system board.

Next steps

1. Install the [base cover](#).
2. Install the [microSD card](#).
3. Install the [SIM card](#).
4. Follow the procedure in [After working inside your computer](#).

Memory modules

Removing the memory modules

Prerequisites

1. Follow the procedure in [Before working inside your computer](#).
2. Remove the [SIM card](#).
3. Remove the [microSD card](#).
4. Remove the [base cover](#).

About this task

The following images indicate the location of the memory modules and provide a visual representation of the removal procedure.

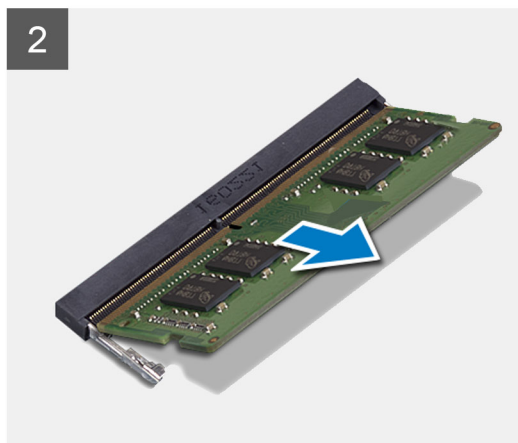
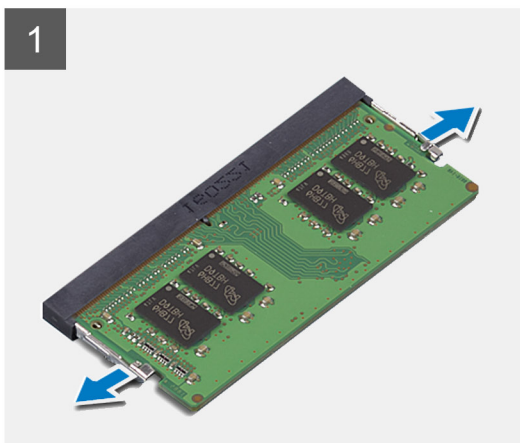
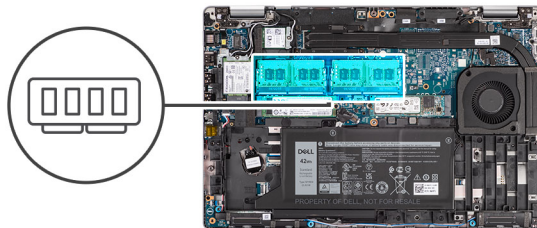

Steps

1. Using your fingertips, spread apart the securing clips on the memory-module slot until the memory module pops up.
2. Slide and remove the memory module from the memory-module slot.

i **NOTE:** Repeat step 1 and 2 if there are two memory modules.

Installing the memory modules

Prerequisites

If you are replacing a component, remove the existing component before performing the installation procedure.

About this task

The following image indicates the location of the memory modules and provides a visual representation of the installation procedure.

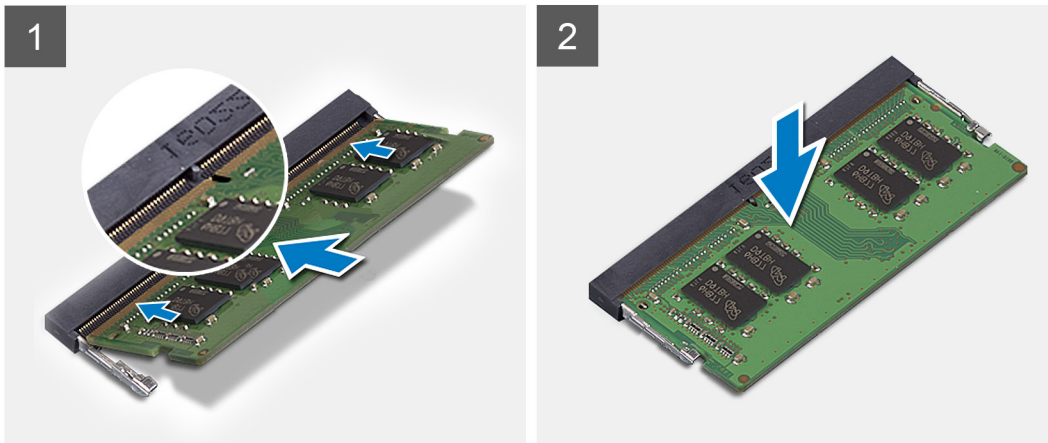
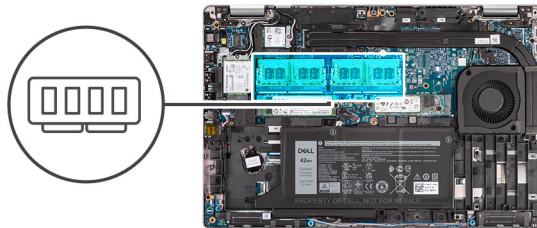

Steps

1. Align the notch on the memory module with the tab on the memory-module slot.
2. Slide the memory module firmly into the slot at an angle and press the memory module down until it clicks into place.

NOTE: If you do not hear the click, remove the memory module and reinstall it.

Next steps

1. Install the [base cover](#).
2. Install the [microSD card](#).
3. Install the [SIM card](#).
4. Follow the procedure in [After working inside your computer](#).

Battery

Lithium-ion battery precautions

CAUTION:

- Exercise caution when handling Lithium-ion batteries.

- Discharge the battery completely before removing it. Disconnect the AC power adapter from the system and operate the computer solely on battery power—the battery is fully discharged when the computer no longer turns on when the power button is pressed.
- Do not crush, drop, mutilate, or penetrate the battery with foreign objects.
- Do not expose the battery to high temperatures, or disassemble battery packs and cells.
- Do not apply pressure to the surface of the battery.
- Do not bend the battery.
- Do not use tools of any kind to pry on or against the battery.
- Ensure any screws during the servicing of this product are not lost or misplaced, to prevent accidental puncture or damage to the battery and other system components.
- If the battery gets stuck inside your computer as a result of swelling, do not try to release it as puncturing, bending, or crushing a lithium-ion battery can be dangerous. In such an instance, contact Dell technical support for assistance. See www.dell.com/contactdell.
- Always purchase genuine batteries from www.dell.com or authorized Dell partners and resellers.

Removing the 3-cell battery

Prerequisites

1. Follow the procedure in [Before working inside your computer](#).
2. Remove the [SIM card](#)
3. Remove the [microSD card](#).
4. Remove the [base cover](#).

i NOTE: If battery is disconnected from system board for service, then there is a delay during system boot-up as the system undergoes RTC battery reset.

About this task

The following images indicate the location of the 3-cell battery and provide a visual representation of the removal procedure.

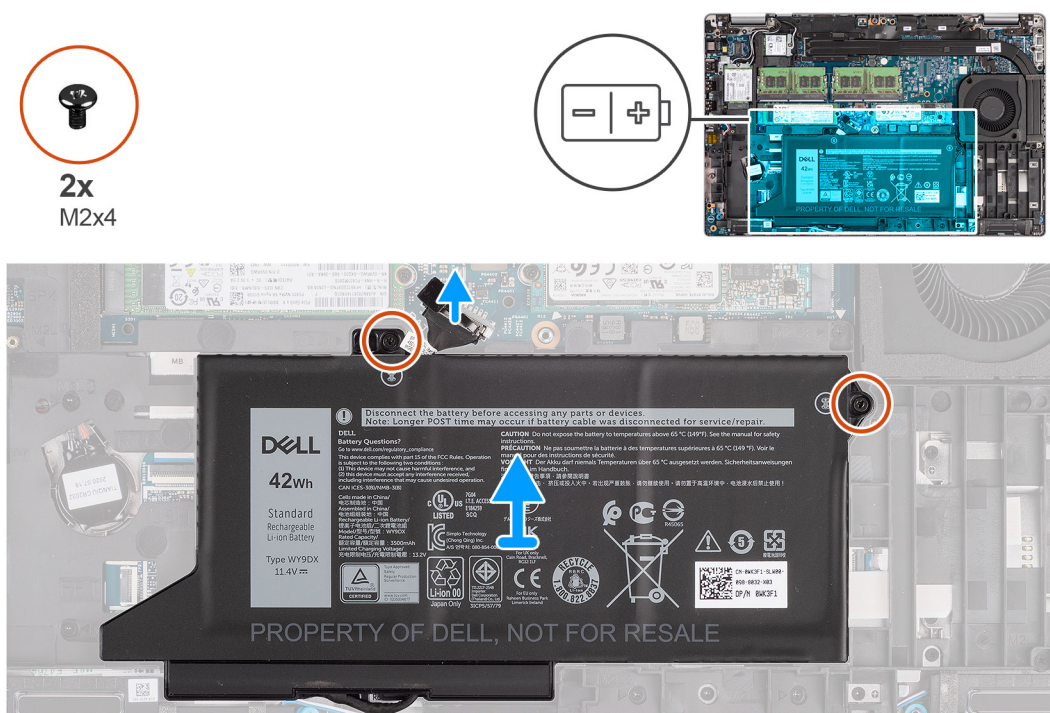

Steps

1. Disconnect the battery cable from the system board, if it was not disconnected earlier.
2. Remove the two screws (M2x4) that secure the battery to the palm-rest assembly and keyboard assembly.
3. Lift the battery off the palm-rest assembly and keyboard assembly.

Installing the 3-cell battery

Prerequisites

If you are replacing a component, remove the existing component before performing the installation procedure.

About this task

The following image indicates the location of the 3-cell battery and provides a visual representation of the installation procedure.

NOTE: If battery is disconnected from system board for service, then there is a delay during system boot-up as the system undergoes RTC battery reset.

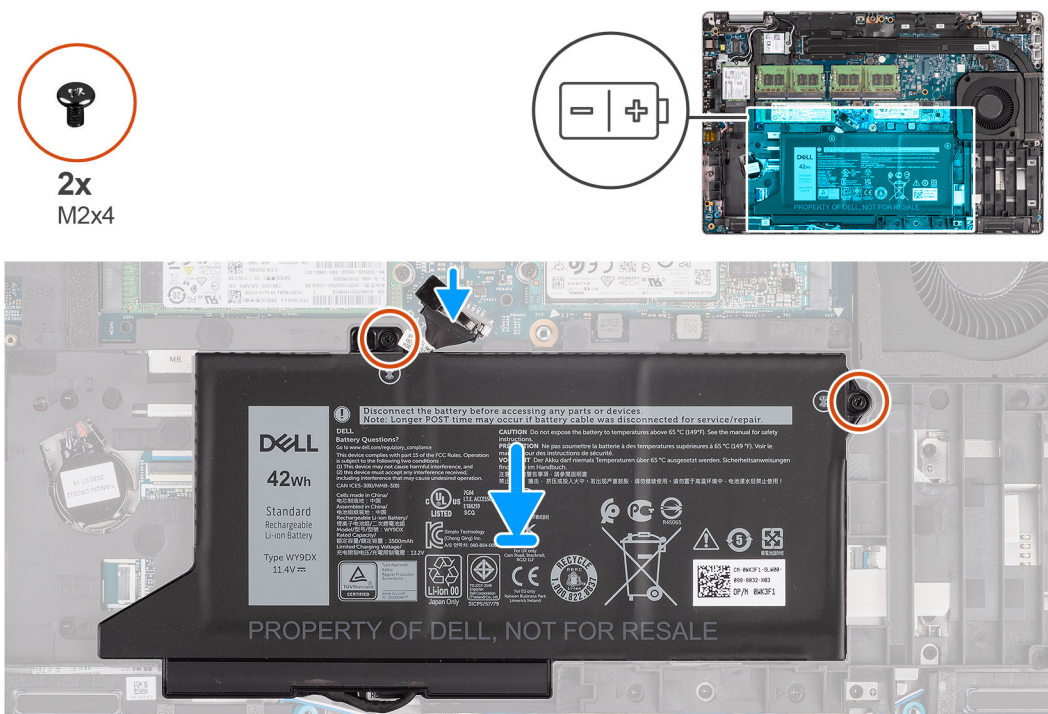

Steps

1. Align and place the battery from the left side on the computer.
2. Replace the two screws (M2x4) that secure the battery to the palm-rest assembly and keyboard assembly.
3. Connect the battery cable to the system board.

Next steps

1. Install the [base cover](#).
2. Install the [microSD card](#).
3. Install the [SIM card](#).
4. Follow the procedure in [After working inside your computer](#).

Removing the 4-cell battery

Prerequisites

1. Follow the procedure in [Before working inside your computer](#).
2. Remove the [SIM card](#)
3. Remove the [microSD card](#).
4. Remove the [base cover](#).

i **NOTE:** If battery is disconnected from system board for service, then there is a delay during system boot-up as the system undergoes RTC battery reset.

About this task

The following images indicate the location of the battery and provide a visual representation of the removal procedure.

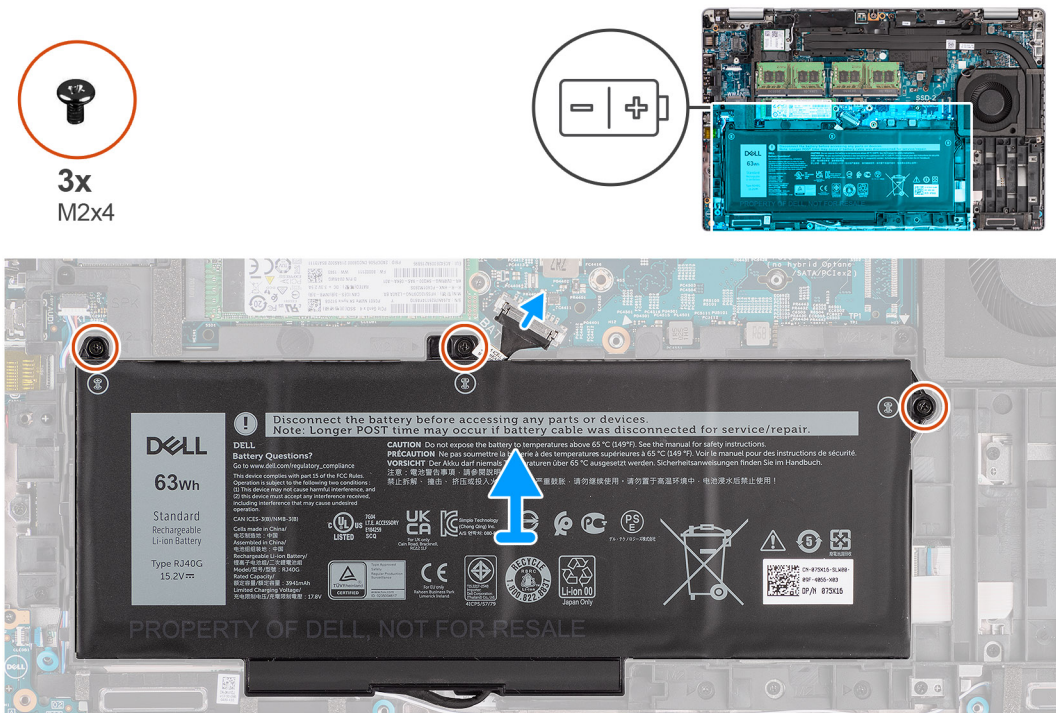

Steps

1. Disconnect the battery cable from the system board, if it was not disconnected earlier.
2. Remove the three screws (M2x4) that secure the battery to the palm-rest assembly and keyboard assembly.
3. Lift the battery off the palm-rest assembly and keyboard assembly.

Installing the 4-cell battery

Prerequisites

If you are replacing a component, remove the existing component before performing the installation procedure.

About this task

The following image indicates the location of the 4-cell battery and provides a visual representation of the installation procedure.

i **NOTE:** If battery is disconnected from system board for service, then there is a delay during system boot-up as the system undergoes RTC battery reset.

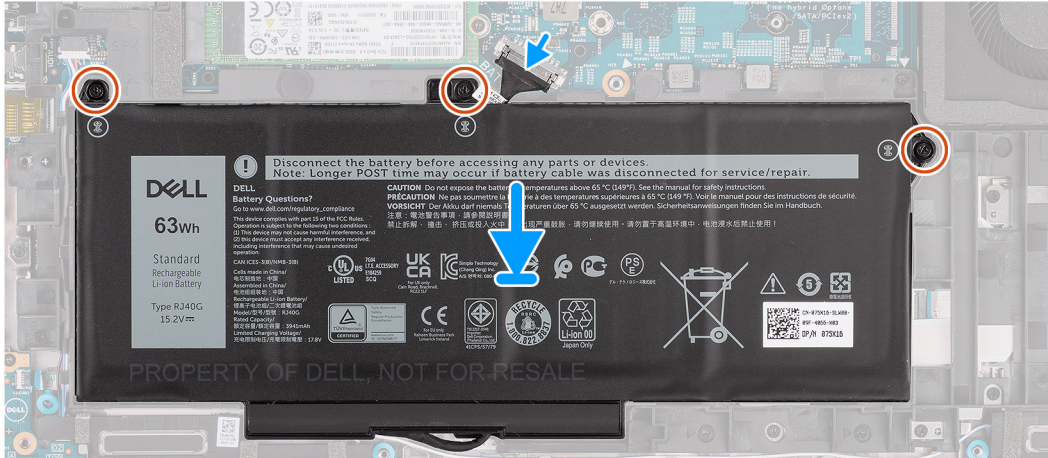
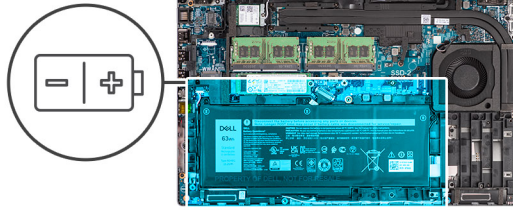

Steps

1. Align and place the battery from the left side on the computer.
2. Replace the three screws (M2x4) that secure the battery to the palm-rest assembly and keyboard assembly.
3. Connect the battery cable to the system board.

Next steps

1. Install the [base cover](#).
2. Install the [microSD card](#).
3. Install the [SIM card](#).
4. Follow the procedure in [After working inside your computer](#).

Battery cable

Removing the battery cable

Prerequisites

1. Follow the procedure in [Before working inside your computer](#).
2. Remove the [SIM card](#)
3. Remove the [microSD card](#).
4. Remove the [base cover](#).
5. Remove the [battery](#).

NOTE: If battery is disconnected from system board for service, then there is a delay during system boot-up as the system undergoes RTC battery reset.

About this task

The following images indicate the location of the battery cable and provide a visual representation of the removal procedure.

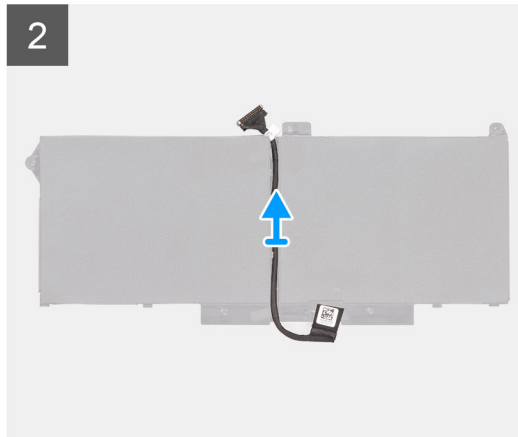
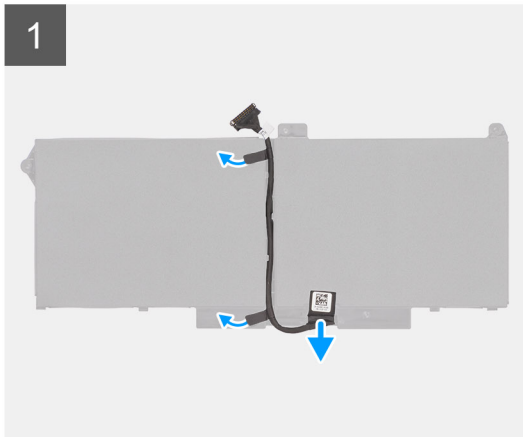

Steps

1. Flip the battery and unrout the battery cable from the routing guides on the battery.
2. Disconnect the battery cable from the connector on the battery.
3. Lift the battery cable away from the battery.

Installing the battery cable

Prerequisites

If you are replacing a component, remove the existing component before performing the installation procedure.

About this task

The following image indicates the location of the battery cable and provides a visual representation of the installation procedure.

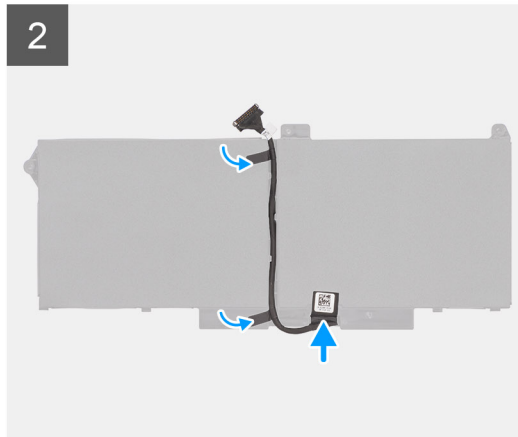
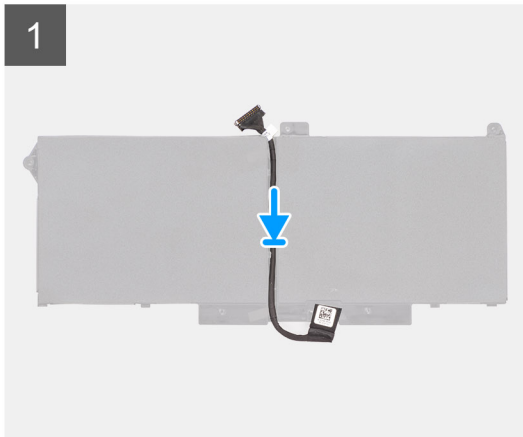

Steps

1. Align and place the battery cable on the battery.
2. Route the battery cable through the routing guides on the battery.
3. Connect the battery cable to the connector on the battery.

Next steps

1. Install the [battery](#).
2. Install the [base cover](#).
3. Install the [microSD card](#).
4. Install the [SIM card](#).
5. Follow the procedure in [After working inside your computer](#).

Assembly inner frame

Removing the assembly inner frame

Prerequisites

1. Follow the procedure in [Before working inside your computer](#).
2. Remove the [SIM card](#).
3. Remove the [microSD card](#).
4. Remove the [base cover](#).
5. Remove the [WLAN card](#).
6. Remove the [WWAN card](#).
7. Remove the [battery](#).

About this task

The following image indicates the location of the assembly inner frame and provides a visual representation of the removal procedure.



12x
M2x3

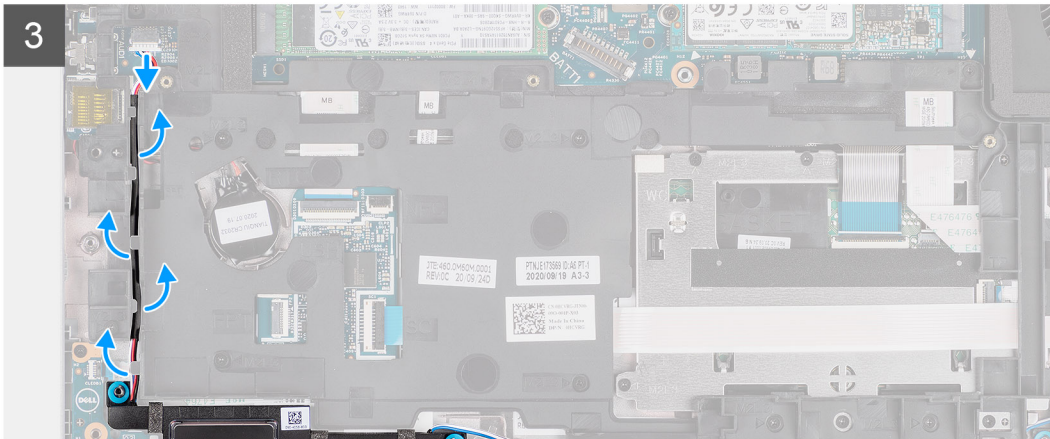
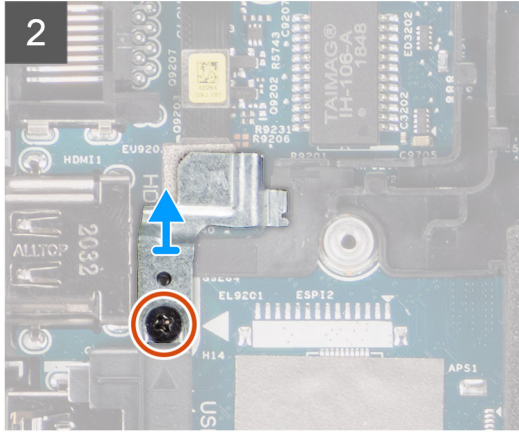
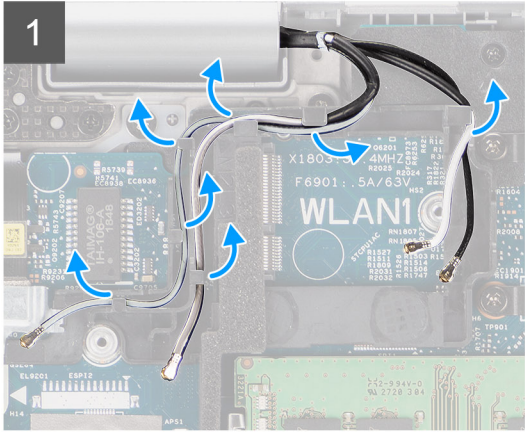
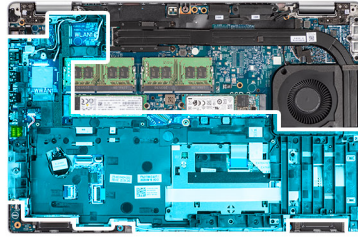

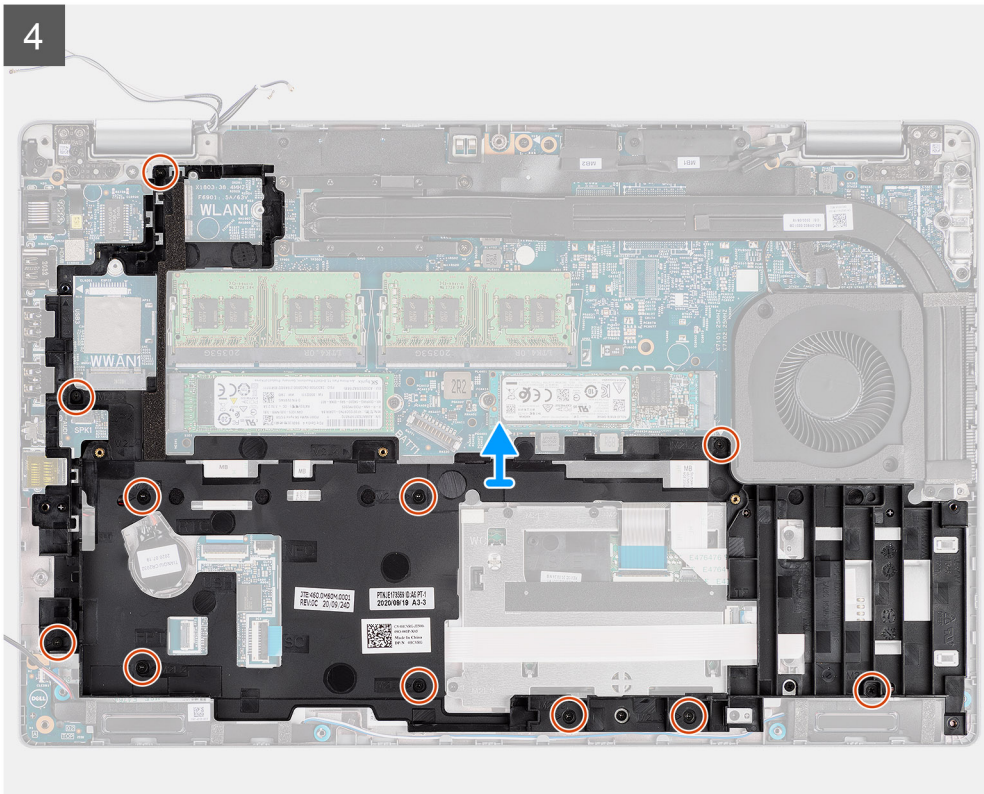

Steps

1. Unroute the antenna cables from the routing guides on the assembly inner frame.
2. Remove the screw (M2x3) that secures the fingerprint bracket to the assembly inner frame.
3. Disconnect the speaker cable from the connector on the system board, and unroute the speaker cable from the routing guides on the assembly inner frame.
4. Remove the eleven screws (M2x3) that secure the assembly inner frame to the system board and the palm-rest assembly .
5. Lift the assembly inner frame off the system board and the palm-rest assembly.

Installing the assembly inner frame

Prerequisites

If you are replacing a component, remove the existing component before performing the installation procedure.

About this task

The following image indicates the location of the assembly inner frame and provides a visual representation of the installation procedure.



12x
M2x3

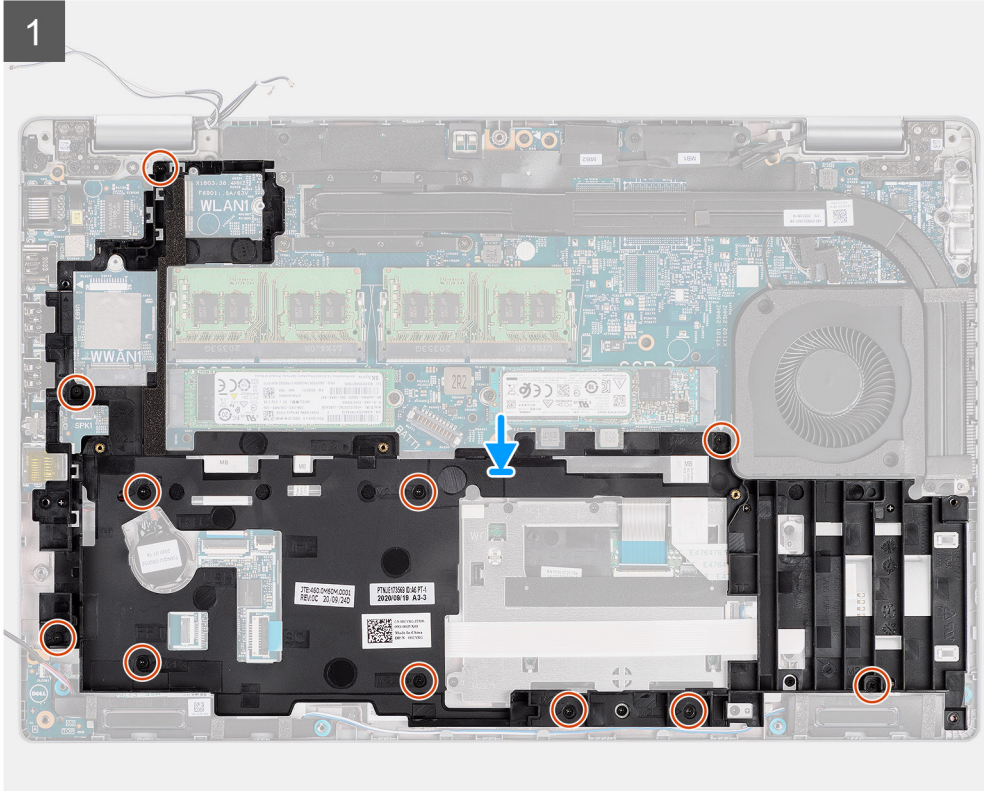
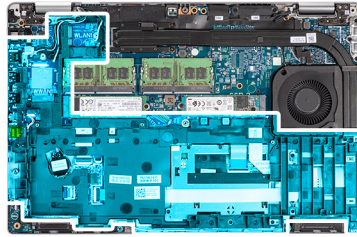

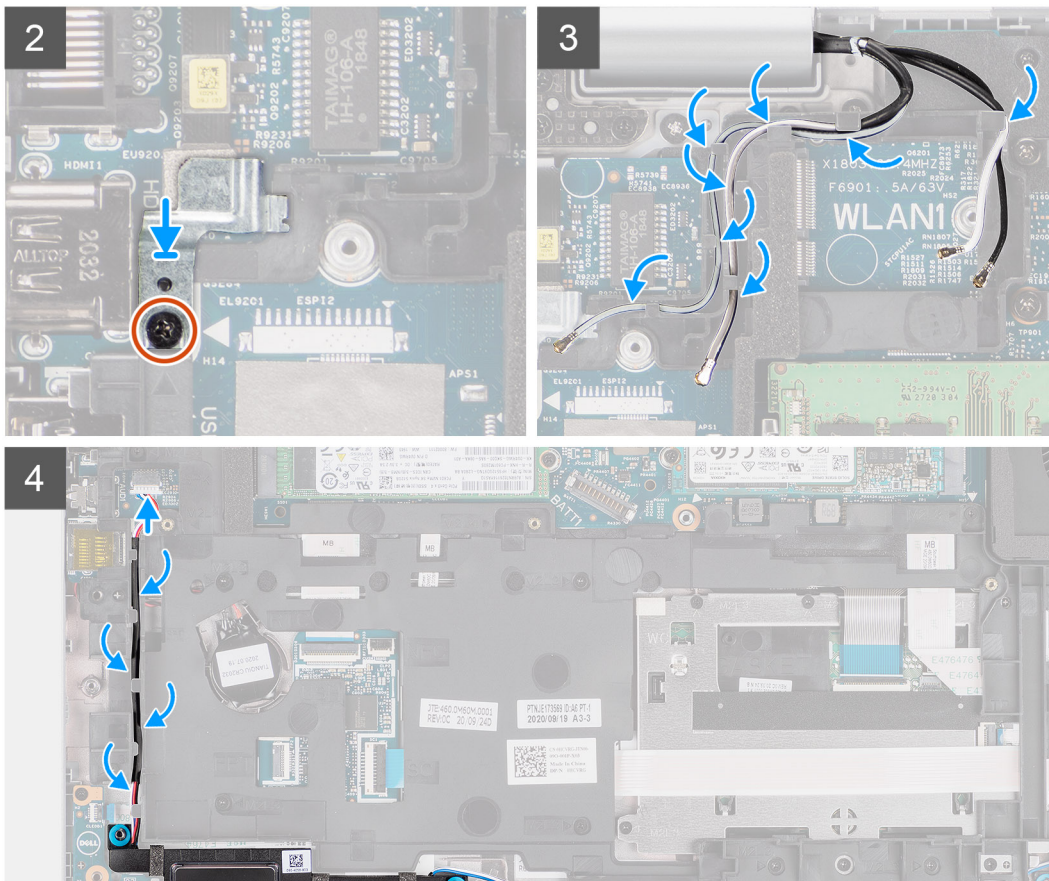

Steps

1. Align the screw holes on the assembly inner frame with the screw holes on the system board and the palm-rest assembly.

NOTE: Ensure that the tab on the top-left corner of the assembly inner frame is installed underneath the tab on the palm-rest assembly.
2. Replace the eleven screws (M2x3) that secure the assembly inner frame to the system board and the palm-rest assembly.
3. Place the fingerprint bracket on the assembly inner frame.
4. Replace the screw (M2x3) that secures the fingerprint bracket to the assembly inner frame.
5. Route the antennas cable through the routing guide on the assembly inner frame.
6. Route the speaker cable through the routing guides on the assembly inner frame, and connect the speaker cable to the connector on the system board.

Next steps

1. Install the [battery](#).
2. Install the [WWAN card](#).
3. Install the [WLAN card](#).
4. Install the [base cover](#).
5. Install the [microSD card](#).
6. Install the [SIM card](#).
7. Follow the procedure in [After working inside your computer](#).

LED board

Removing the LED board

Prerequisites

1. Follow the procedure in [Before working inside your computer](#).
2. Remove the [SIM card](#).
3. Remove the [microSD card](#).
4. Remove the [base cover](#).
5. Remove the [WLAN card](#).
6. Remove the [WWAN card](#).
7. Remove the [battery](#).
8. Remove the [assembly inner frame](#).

About this task

The following image indicates the location of the LED board and provides a visual representation of the removal procedure.



1x
M2x3

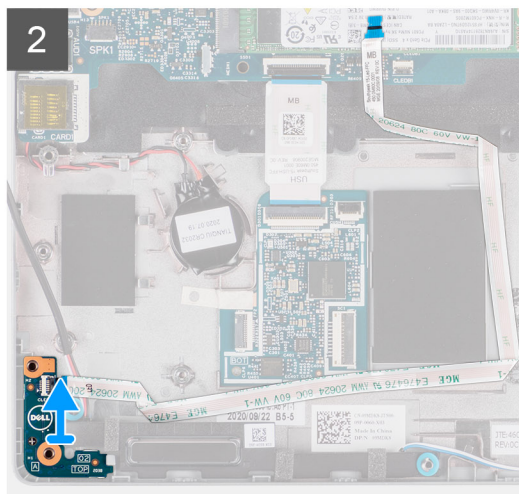
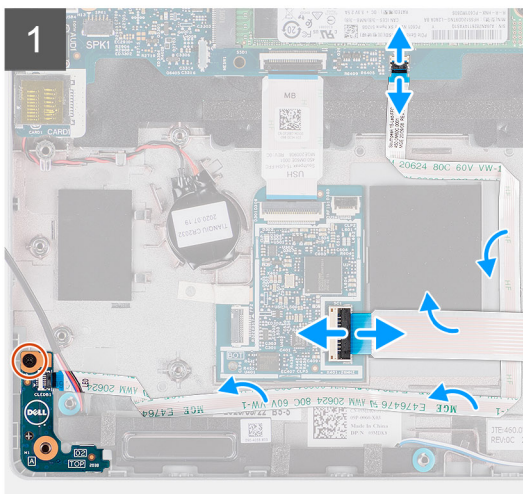
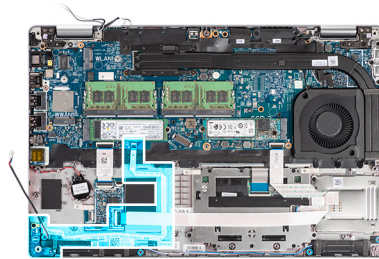

Steps

1. Open the latch and disconnect the smartcard reader cable from the connector on the USH-daughter board.
2. Remove the smartcard reader cable away from the USH-daughter board.
3. Disconnect the LED-board cable from the connector on the system board.
4. Remove the single screw (M2x3) that secures the LED board to the palm-rest assembly.
5. Lift the LED board and cable away from the palm-rest assembly.

Installing the LED board

Prerequisites

If you are replacing a component, remove the existing component before performing the installation procedure.

About this task

The following image indicates the location of the LED board and provides a visual representation of the installation procedure.



1x
M2x3

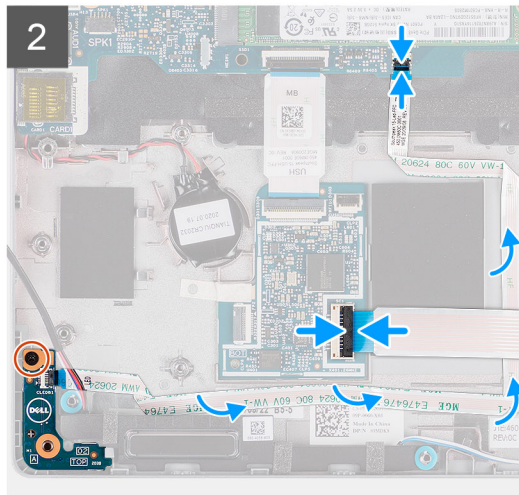
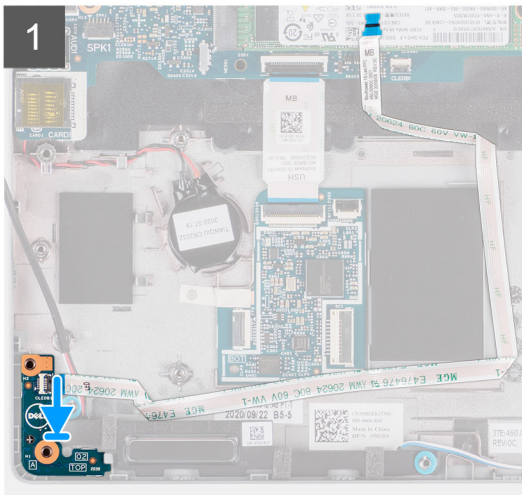
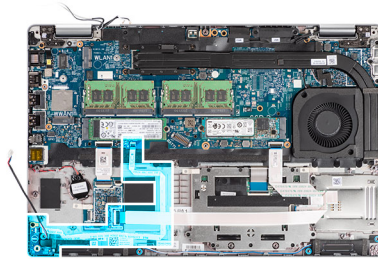

Steps

1. Align the screw hole on the LED board with the screw hole on the palm-rest assembly.
2. Replace the single screw (M2x3) to secure the LED board to the palm-rest assembly.
3. Route the LED-board cable and connect the cable to the connector on the system board.
4. Route the smartcard reader cable on the palm-rest assembly.
5. Connect the smartcard reader cable to the connector on the USH-daughter board and close the latch.

Next steps

1. Install the [assembly inner frame](#).
2. Install the [battery](#).
3. Install the [WWAN card](#).
4. Install the [WLAN card](#).
5. Install the [base cover](#).
6. Install the [microSD card](#).
7. Install the [SIM card](#).
8. Follow the procedure in [After working inside your computer](#).

System fan

Removing the system fan

Prerequisites

1. Follow the procedure in [Before working inside your computer](#).
2. Remove the [SIM card](#).
3. Remove the [microSD card](#).

4. Remove the [base cover](#).
5. Remove the [battery](#).

About this task

The following images indicate the location of the system fan and provide a visual representation of the removal procedure.

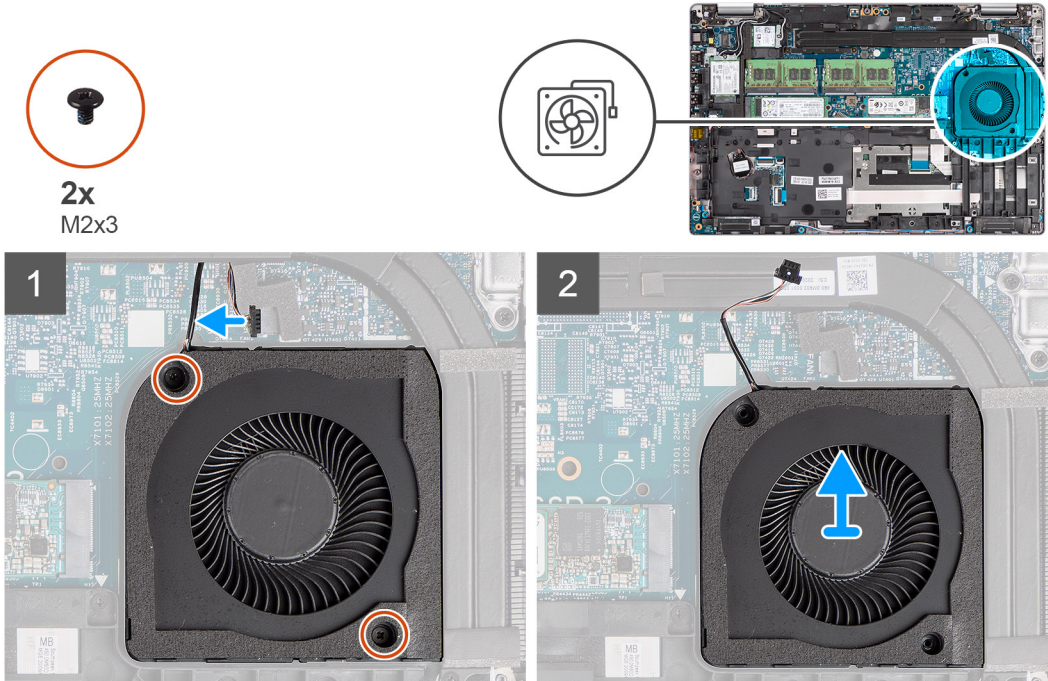

Steps

⚠ CAUTION: Do not damage the thermal fan sponge during any replacement procedures. Damaging the sponge reduces the effectiveness of the heat dispersion.

1. Disconnect the system-fan cable from the system board.
2. Remove the two screws (M2x3) that secure the system fan to the palm-rest assembly.
3. Lift the system fan, along with its cable, off the palm-rest assembly.

Installing the system fan

Prerequisites

If you are replacing a component, remove the existing component before performing the installation procedure.

About this task

The following image indicates the location of the system fan and provide a visual representation of the installation procedure.



2x
M2x3

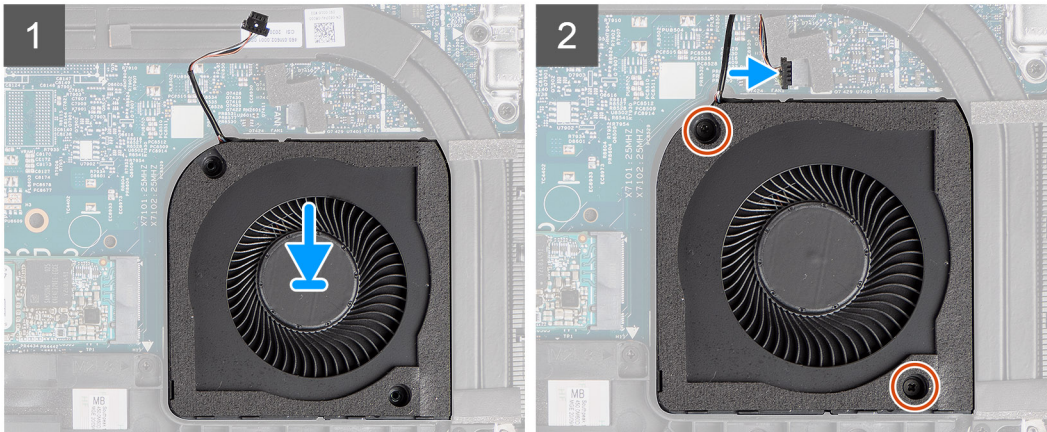
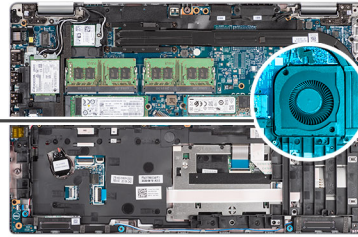
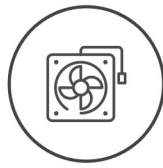

Steps

1. Align the screw holes on the system fan with the screw holes on the palm-rest assembly.
2. Replace the two screws (M2x3) to secure the system fan to the palm-rest assembly.
3. Connect the system-fan cable to the connector on the system board.

Next steps

1. Install the [battery](#).
2. Install the [base cover](#).
3. Install the [microSD card](#).
4. Install the [SIM card](#).
5. Follow the procedure in [After working inside your computer](#).

Heat sink

Removing the heat sink (for computers shipped with integrated graphics card)

Prerequisites

1. Follow the procedure in [before working inside your computer](#).



CAUTION: The heat sink may become hot during normal operation. Allow sufficient time for the heat sink to cool before you touch it.

2. Remove the [SIM card](#).
3. Remove the [microSD card](#).
4. Remove the [base cover](#).
5. Remove the [battery](#).

About this task

The following image indicates the location of the heat sink and provides a visual representation of the removal procedure.

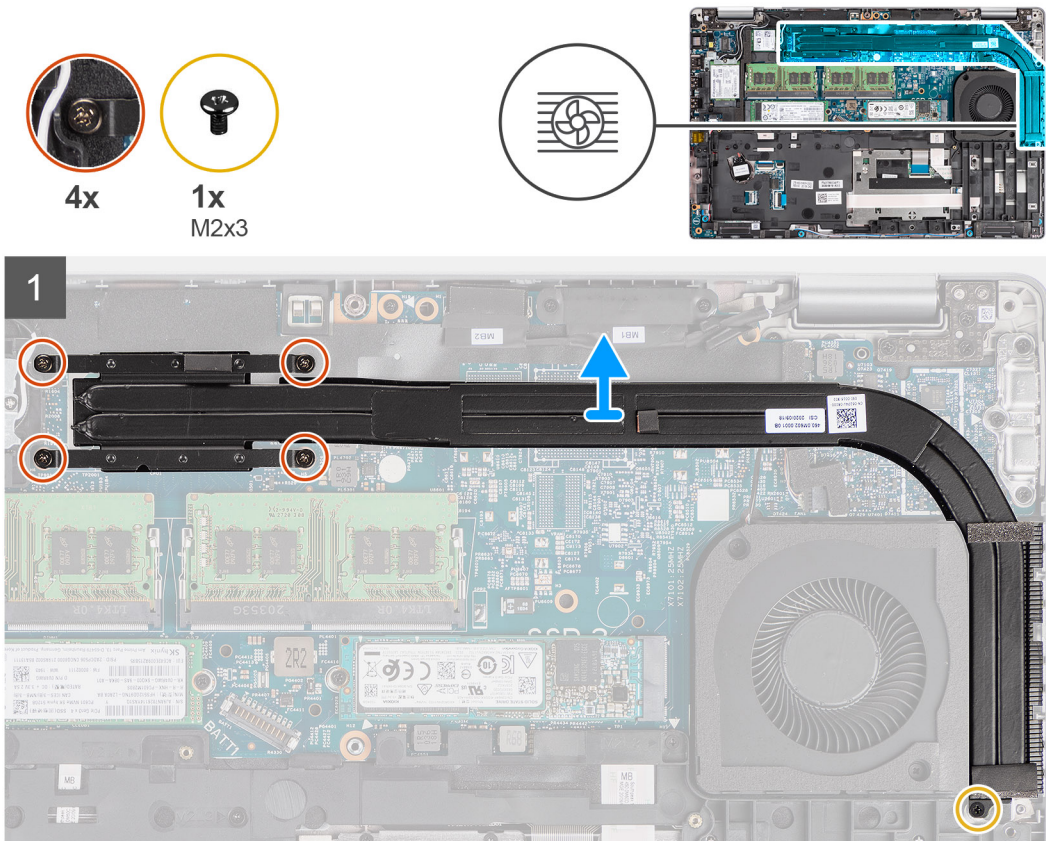

Steps

1. Remove the screw (M2x3) that secures the heat sink to the palm-rest assembly.
2. Loosen the four captive screws that secure the heat sink to the system board.
3. Lift the heat sink off the system board.

Installing the heat sink (for computers shipped with integrated graphics card)

Prerequisites

If you are replacing a component, remove the existing component before performing the installation procedure.

About this task

The following image indicates the location of the heat sink and provides a visual representation of the installation procedure.

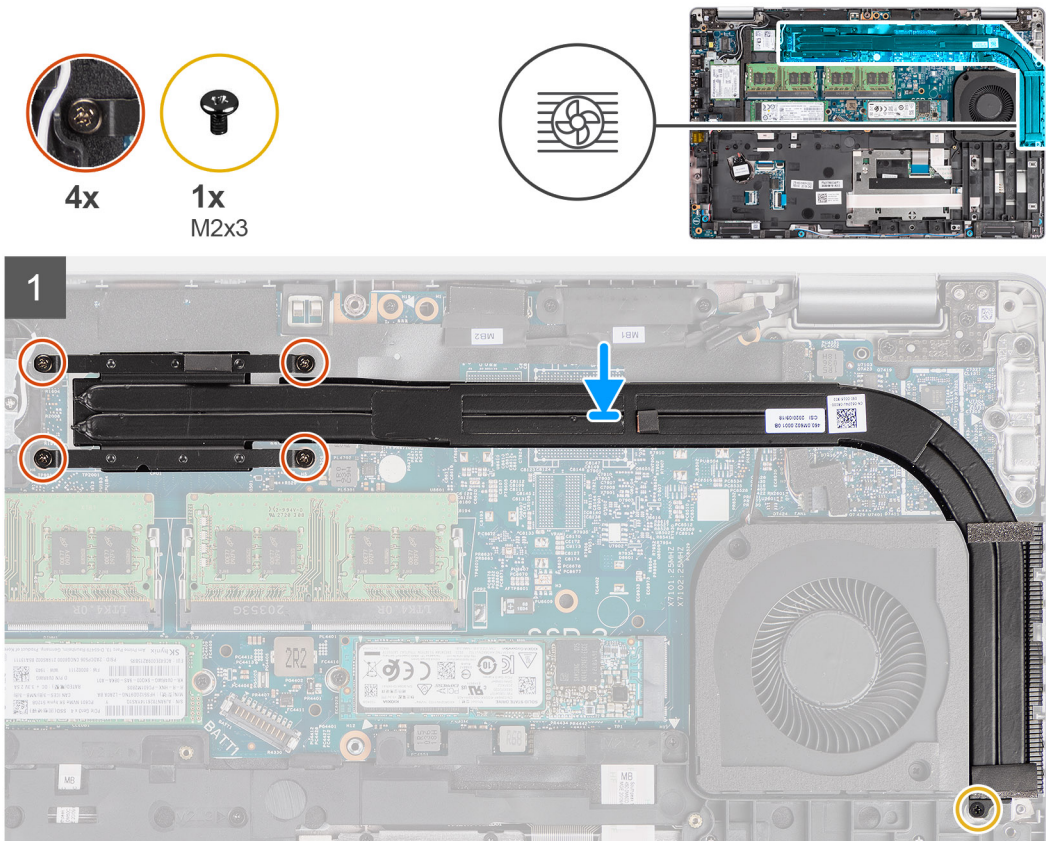

Steps

1. Align the screw holes on the heat sink with the screw holes on the system board.
2. Tighten the four captive screws that secure the heat sink to the system board.
3. Replace the screw (M2x3) that secures the heat sink to the palm-rest assembly.

Next steps

1. Install the [battery](#).
2. Install the [base cover](#).
3. Install the [microSD card](#).
4. Install the [SIM card](#).
5. Follow the procedure in [After working inside your computer](#).

Removing the heat sink (for computers shipped with discrete graphics card)

Prerequisites

1. Follow the procedure in [before working inside your computer](#).
 - NOTE:** The heat sink may become hot during normal operation. Allow sufficient time for the heat sink to cool before you touch it.
2. Remove the [SIM card](#).
3. Remove the [microSD card](#).
4. Remove the [base cover](#).
5. Remove the [battery](#).

About this task

The following image indicates the location of the heat sink and provides a visual representation of the removal procedure.

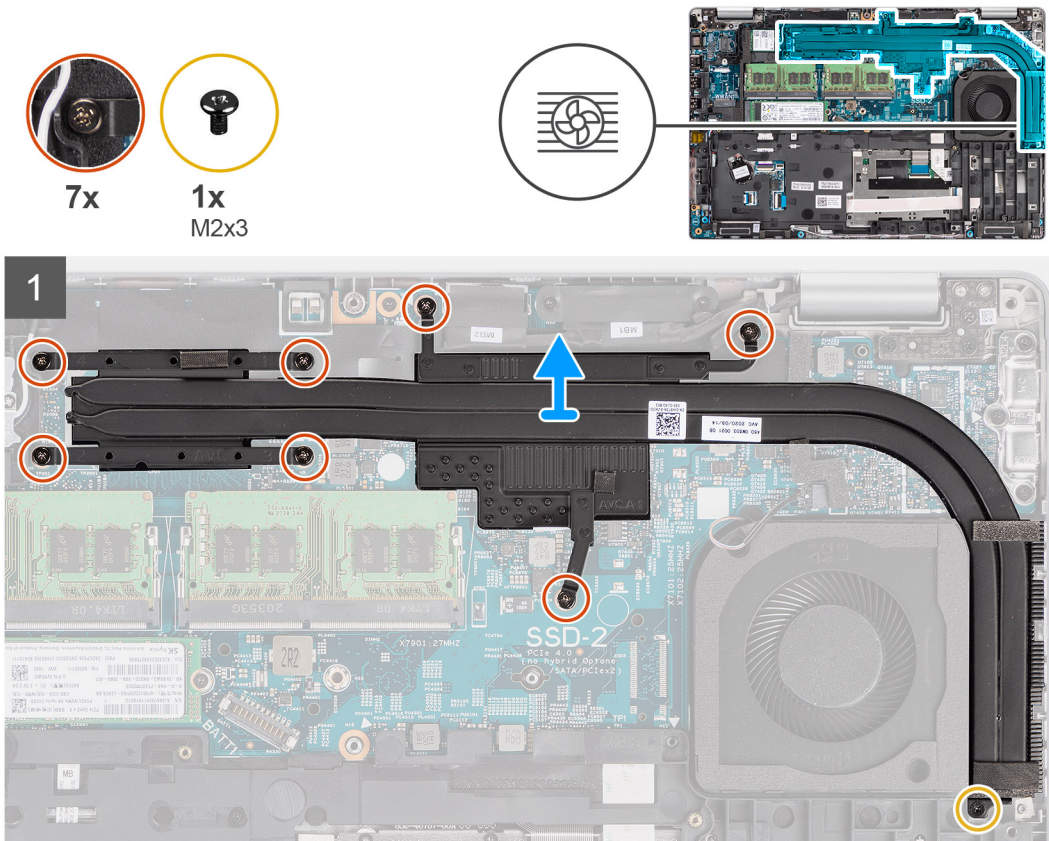

Steps

1. Remove the screw (M2x3) that secures the heat sink to the palm-rest assembly
2. Loosen the seven captive screws that secure the heat sink to the system board.
3. Lift the heat sink off the system board.

Installing the heat sink (for computers shipped with discrete graphics card)

Prerequisites

If you are replacing a component, remove the existing component before performing the installation procedure.

About this task

The following image indicates the location of the heat sink and provides a visual representation of the installation procedure.

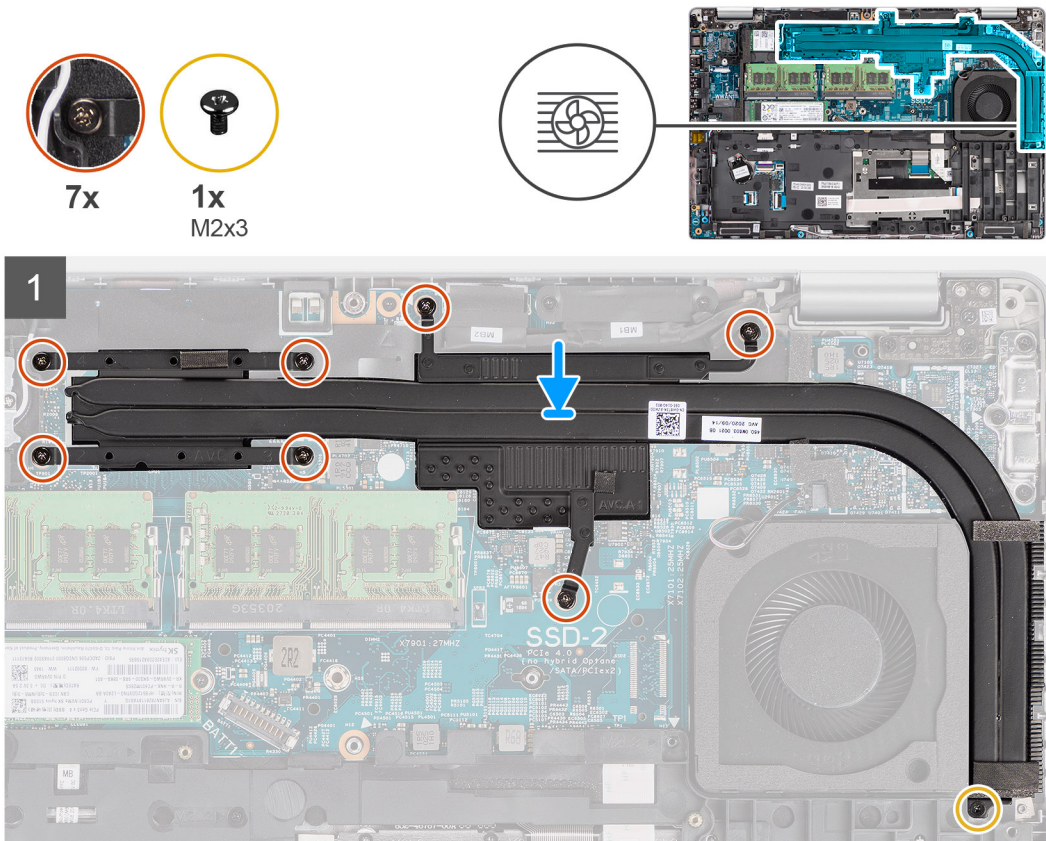

Steps

1. Align the screw holes on the heat sink with the screw holes on the system board.
2. Tighten the seven captive screws that secure the heat sink to the system board.
3. Replace the screw (M2x3) that secures the heat sink to the palm-rest assembly.

Next steps

1. Install the [battery](#).
2. Install the [base cover](#).
3. Install the [microSD card](#).
4. Install the [SIM card](#).
5. Follow the procedure in [After working inside your computer](#).

Speakers

Removing the speaker

Prerequisites

1. Follow the procedure in [Before working inside your computer](#).
2. Remove the [SIM card](#).
3. Remove the [microSD card](#).
4. Remove the [base cover](#).
5. Remove the [battery](#).
6. Remove the [assembly inner frame](#).

About this task

The following images indicate the location of the speaker and provide a visual representation of the removal procedure.

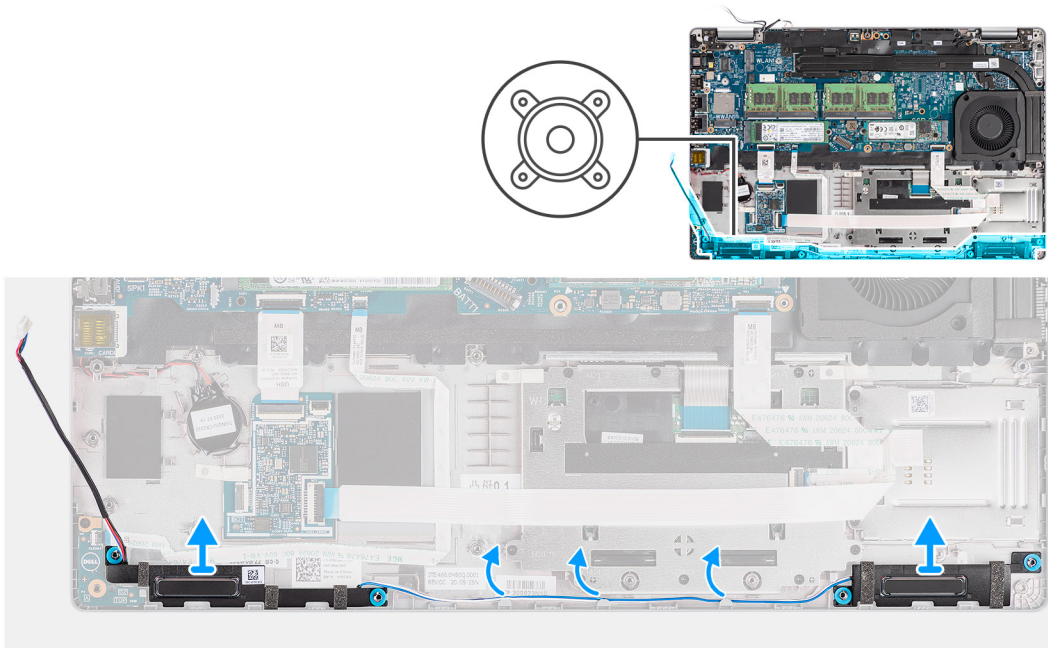

Steps

1. Unroute the speaker cable from the routing guides on the palm-rest assembly.
2. Lift the speakers along with the cable off the palm-rest assembly.

Installing the speaker

Prerequisites

If you are replacing a component, remove the existing component before performing the installation procedure.

About this task

The following image indicates the location of the speaker and provides a visual representation of the installation procedure.

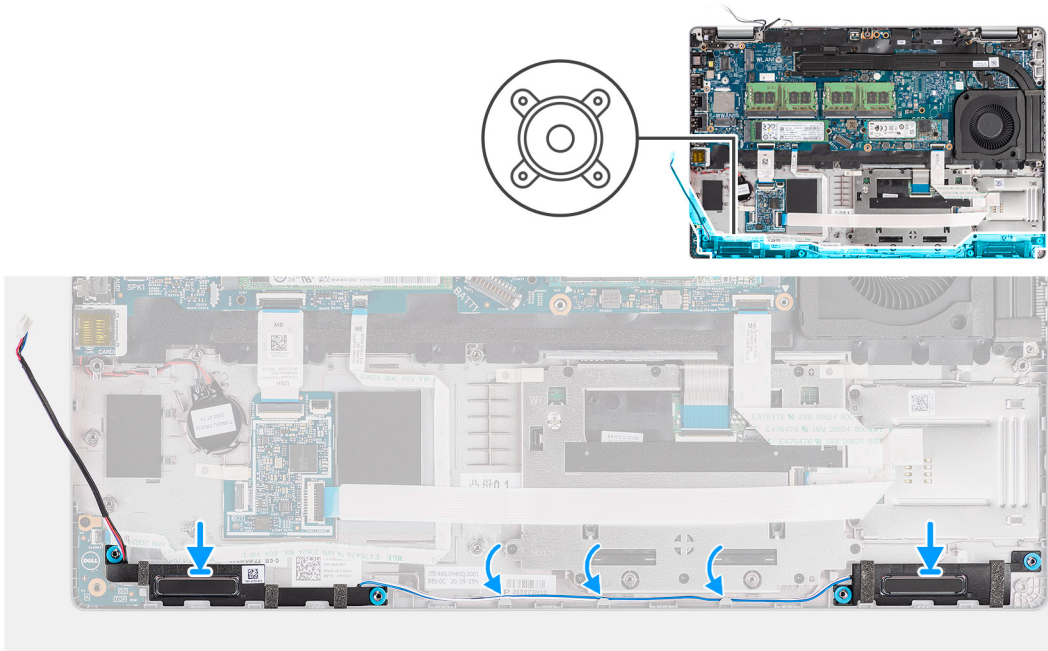

Steps

1. Align and place the speakers on the palm-rest assembly.
2. Route the speaker cable through the routing guide on palm-rest assembly.

Next steps

1. Install the [assembly inner frame](#)
2. Install the [battery](#).
3. Install the [base cover](#).
4. Install the [microSD card](#).
5. Install the [SIM card](#).
6. Follow the procedure in [After working inside your computer](#).

System board

Removing the system board

Prerequisites

1. Follow the procedure in [Before working inside your computer](#).
2. Remove the [SIM card](#).
3. Remove the [microSD card](#).
4. Remove the [base cover](#).
5. Remove the [solid-state drive](#).
6. Remove the [memory module](#).
7. Remove the [WLAN card](#).
8. Remove the [WWAN card](#).
9. Remove the [battery](#).
10. Remove the [system fan](#).
11. Remove the [assembly inner frame](#).

About this task

The following images indicate the location of the system board and provide a visual representation of the removal procedure.

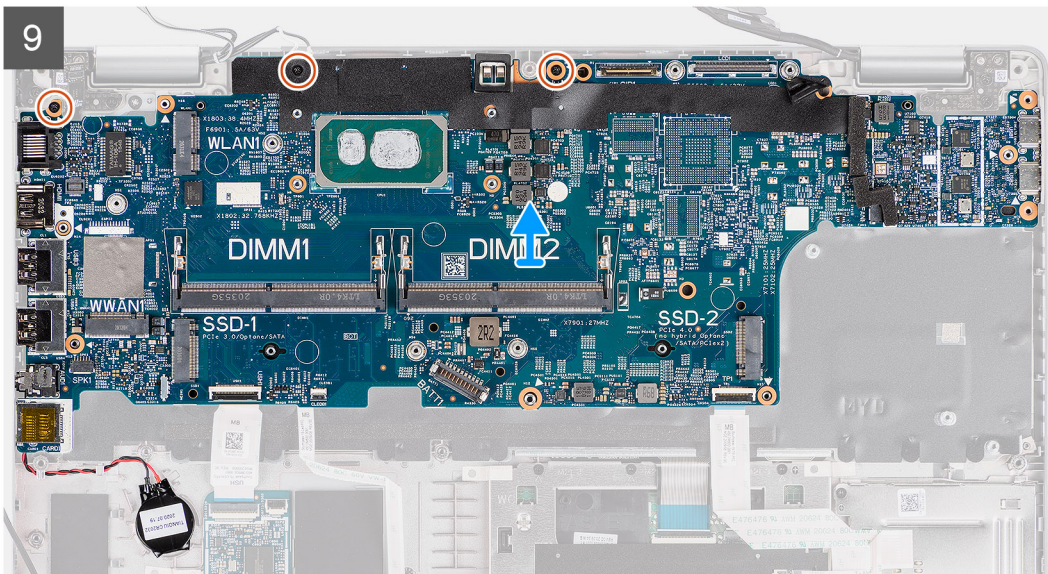
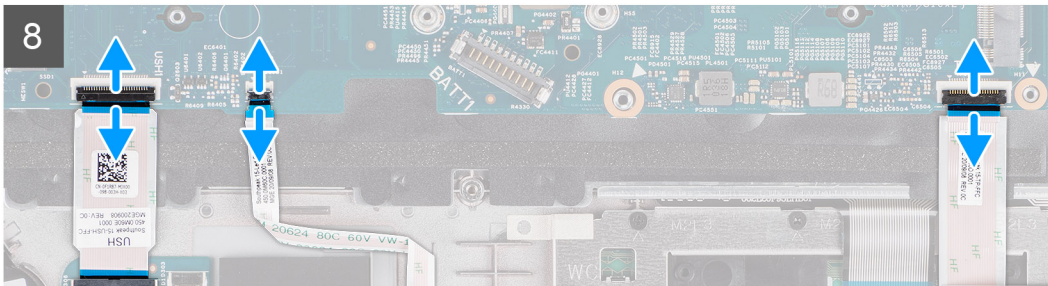
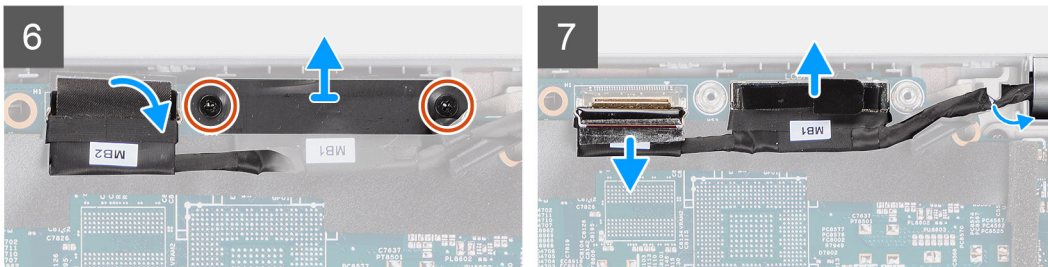
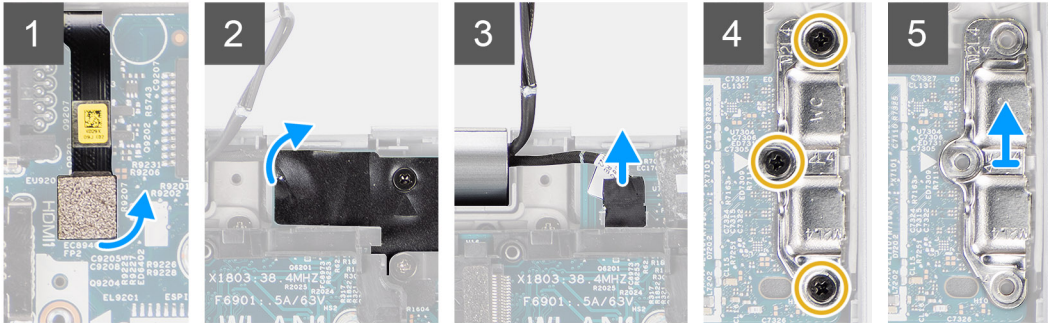
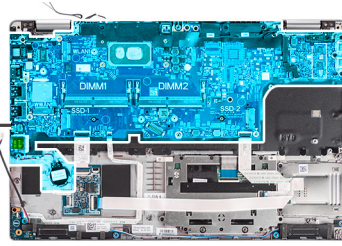

Steps

i NOTE: The system board can be removed and installed along with the thermal module attached, to preserve the thermal bond between the system board and heat-sink. In order to do so, technicians must remove the two M2x5 screws securing the system fan to the palm-rest assembly.

1. Disconnect the fingerprint cable from the connector on the system board.
2. Peel the adhesive tape and disconnect the sensor-board cable from the connector on the system board.
3. Remove the three screws (M2x4) that secure the USB Type-C bracket to the system board.
4. Remove the two screws (M2x3) that secure the eDP cable bracket to the system board.
5. Lift the eDP cable bracket away from the system.
6. Peel the tape that secures the display cable to the system board.
7. Using the pull tab, disconnect the display cable from the connector on the system board.
8. Disconnect the eDP cable from the connector on the system board and unroute it from the routing guide.
9. Open the latch and disconnect the USH board cable from the system board.
10. Open the latch and disconnect the LED board cable from the system board.
11. Open the latch and disconnect the clickpad cable from the system board.
12. Pry the coin-cell battery off the palm-rest assembly and remove it from the routing guides on the palm-rest assembly.
13. Remove the three screws (M2x3) that secure the system board to the palm-rest assembly and keyboard assembly.
14. Lift the system board off the palm-rest assembly and keyboard assembly.
15. Flip the system board and disconnect the coin-cell battery cable from the connector on the system board.

Installing the system board

Prerequisites

If you are replacing a component, remove the existing component before performing the installation procedure.

About this task

The following image indicates the location of the system board and provides a visual representation of the installation procedure.

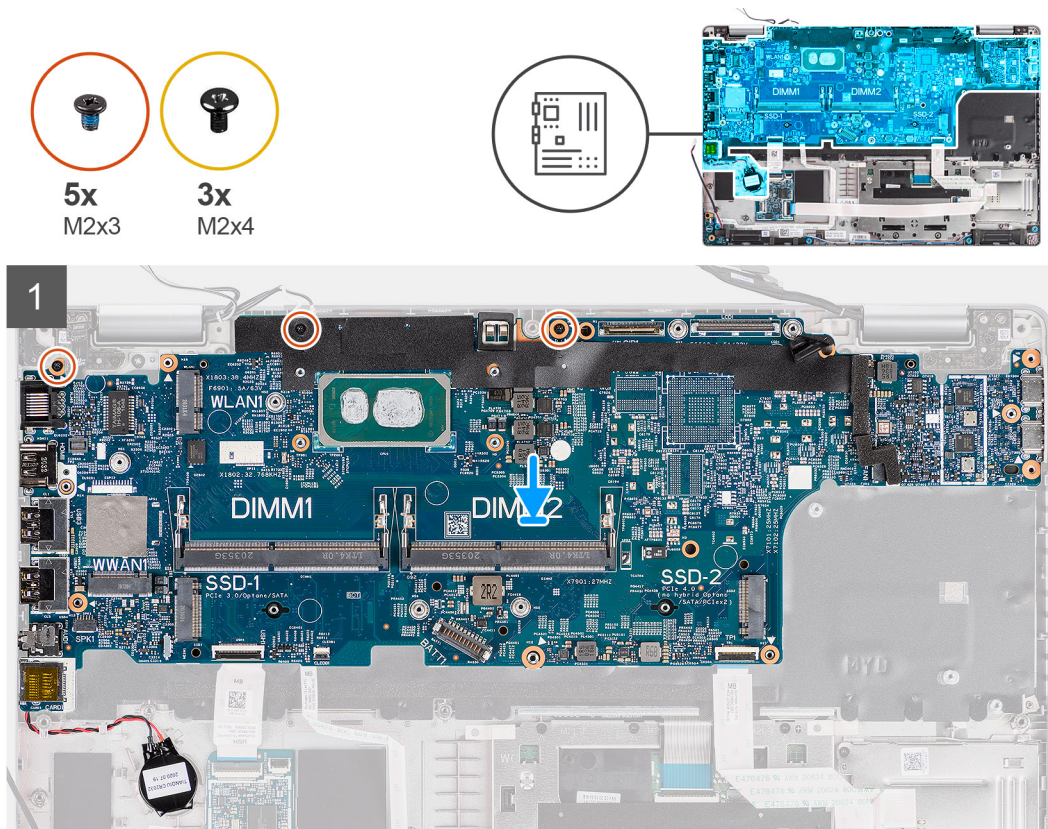

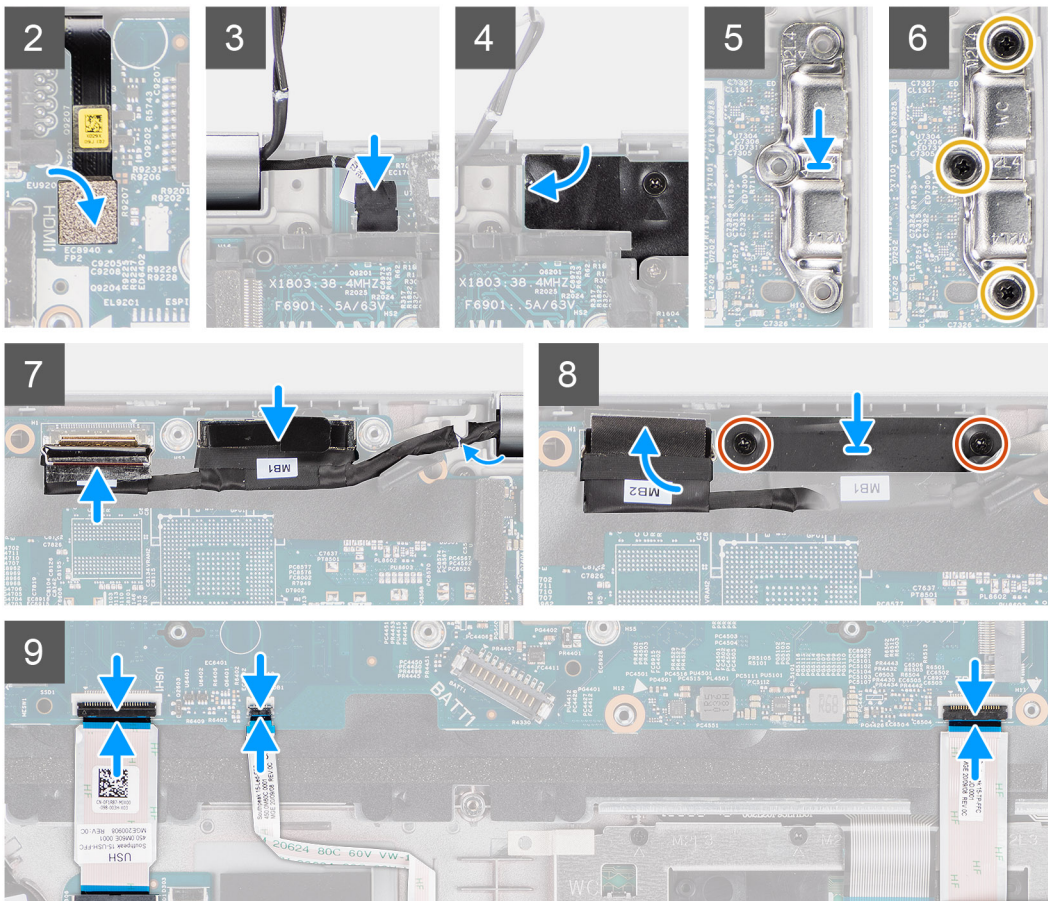

Steps

1. Flip the system board and connect the coin-cell battery cable to the connector on the system board.
2. Flip over and slide the system board to make the USB Type-C connector to toe-in to the hinge saddle and align the screw holes on the system board with the screw holes on the palm-rest assembly and keyboard assembly.
3. Replace the three screws (M2x3) to secure the system board to the palm-rest assembly and keyboard assembly.
4. Route the coin-cell battery cable through the routing guide on palm-rest assembly and adhere the coin-cell battery on the palm-rest assembly.
5. Connect the finger print cable to the connector on the system board.
6. Connect the sensor-board cable to the connector on the system board and adhere the tape to secure the cable to the system board.
7. Align and place the USB Type-C bracket on the system board.
8. Replace the three screws (M2x4) that secure the USB Type-C bracket to the system board.
9. Route the display and eDP cable through the routing guide on the system board.
10. Connect the eDP cable to the connector on the system board.
11. Connect the display cable to the connector on the system board.
12. Adhere the tape that secures the display cable to the system board.
13. Align the screw holes on the eDP cable bracket with the screw holes on the system board.
14. Replace the two screws (M2x3) that secure the eDP cable bracket to the system board.
15. Connect the USH board cable to the system board and close the latch to secure the cable to the system board.
16. Connect the LED board cable to the system board and close the latch to secure the cable to the system board.
17. Connect the clickpad cable to the system board and close the latch to secure the cable to the system board.

Next steps

1. Install the [assembly inner frame](#).
2. Install the [system fan](#).

3. Install the [battery](#).
4. Install the [WWAN card](#).
5. Install the [WLAN card](#).
6. Install the [memory module](#).
7. Install the [base cover](#).
8. Install the [microSD card](#).
9. Install the [SIM card](#).
10. Follow the procedure in [After working inside your computer](#).

Power-button board

Removing the power-button board

Prerequisites

1. Follow the procedure in [Before working inside your computer](#).
2. Remove the [SIM card](#).
3. Remove the [microSD card](#).
4. Remove the [base cover](#).
5. Remove the [WLAN card](#).
6. Remove the [WWAN card](#).
7. Remove the [battery](#).
8. Remove the [system fan](#).
9. Remove the [assembly inner frame](#).
10. Remove the [system board](#).

About this task

The following images indicate the location of the power-button board and provide a visual representation of the removal procedure.



2x
M2x2

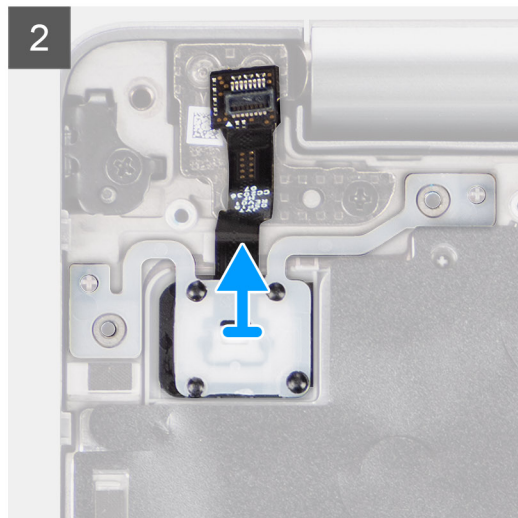
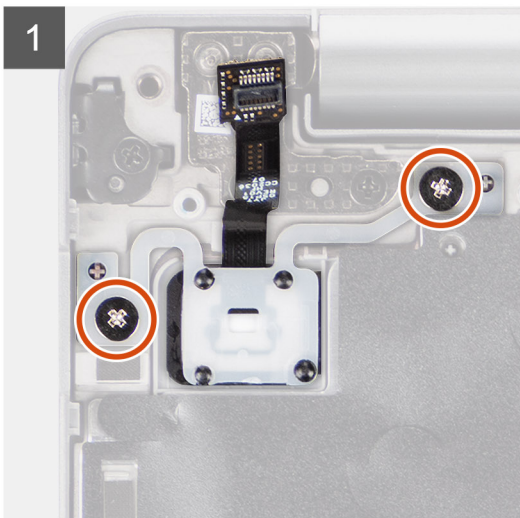
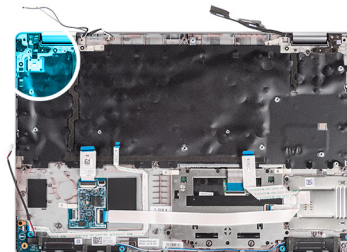

Steps

1. Remove the two screws (M2x2) that secure the power-button board to the palm-rest assembly.
2. Lift the power-button board off the palm-rest assembly.

Installing the power-button board

About this task

The following images indicate the location of the power-button board and provide a visual representation of the installation procedure.



2x
M2x2

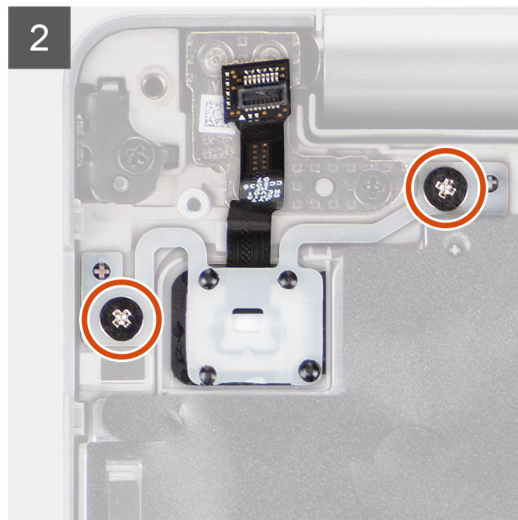
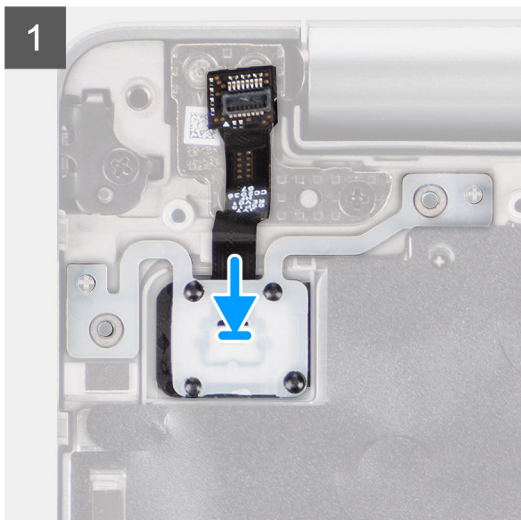
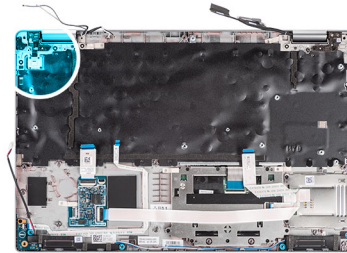

Steps

1. Align and place the power-button board on the palm-rest assembly.
2. Replace the two screws (M2x2) that secure the power-button board to the palm-rest assembly.

Next steps

1. Install the [system board](#).
2. Install the [assembly inner frame](#).
3. Install the [system fan](#).
4. Install the [battery](#).
5. Install the [WWAN card](#).
6. Install the [WLAN card](#).
7. Install the [base cover](#).
8. Install the [microSD card](#).
9. Install the [SIM card](#).
10. Follow the procedure in [After working inside your computer](#).

Smart card reader

Removing the smart card reader

Prerequisites

1. Follow the procedure in [Before working inside your computer](#).
2. Remove the [SIM card](#).
3. Remove the [microSD card](#).
4. Remove the [base cover](#).
5. Remove the [WLAN card](#).
6. Remove the [WWAN card](#).
7. Remove the [battery](#).
8. Remove the [assembly inner frame](#).

 **NOTE:** For models with smart card reader configuration, the smart card reader is pre-installed in the replacement palm-rest assembly.

About this task

The following images indicate the location of the smart card reader and provide a visual representation of the removal procedure.



2x
M2x3

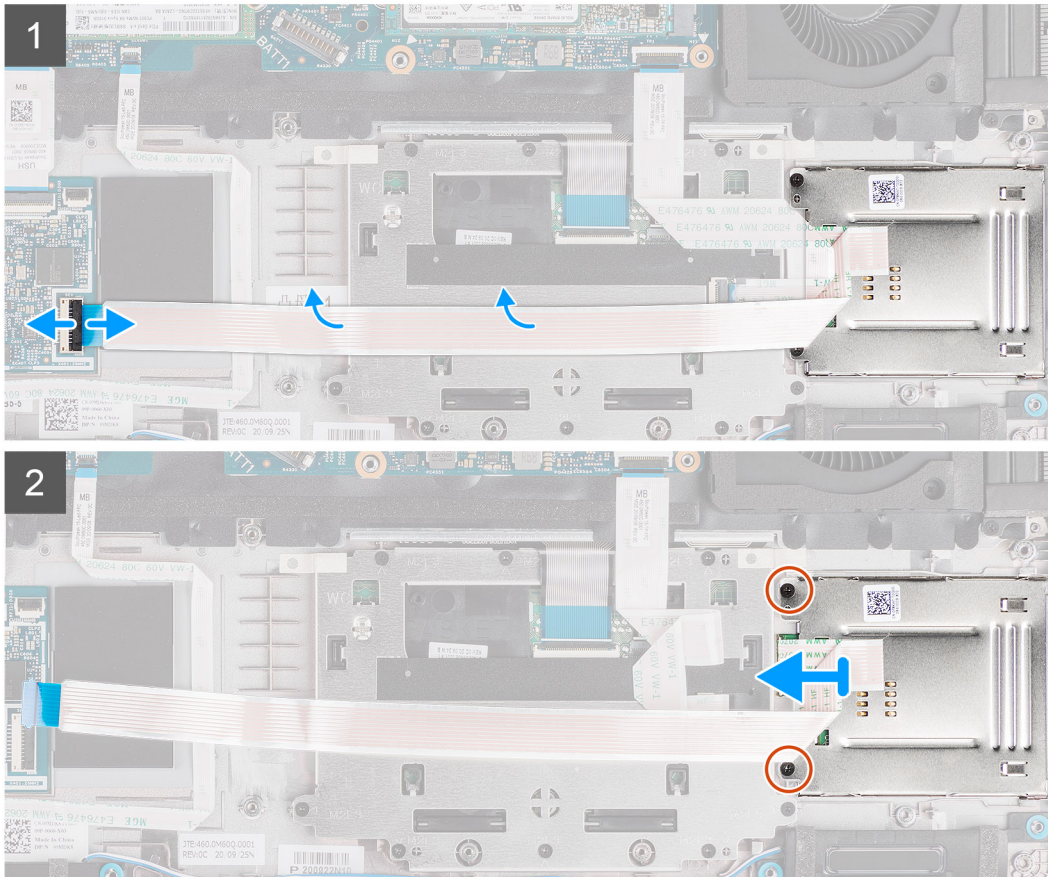
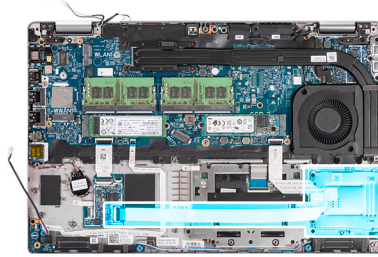

Steps

1. Open the latch and disconnect the smart card reader cable from the connector on the USH board.
2. Remove the two screws (M2x3) that secure the smart card reader to the palm-rest assembly.
3. Lift the smart card reader off the palm-rest assembly.

Installing the smart card reader

Prerequisites

If you are replacing a component, remove the existing component before performing the installation procedure.

About this task

The following image indicates the location of the smart card reader and provides a visual representation of the installation procedure.



2x
M2x3

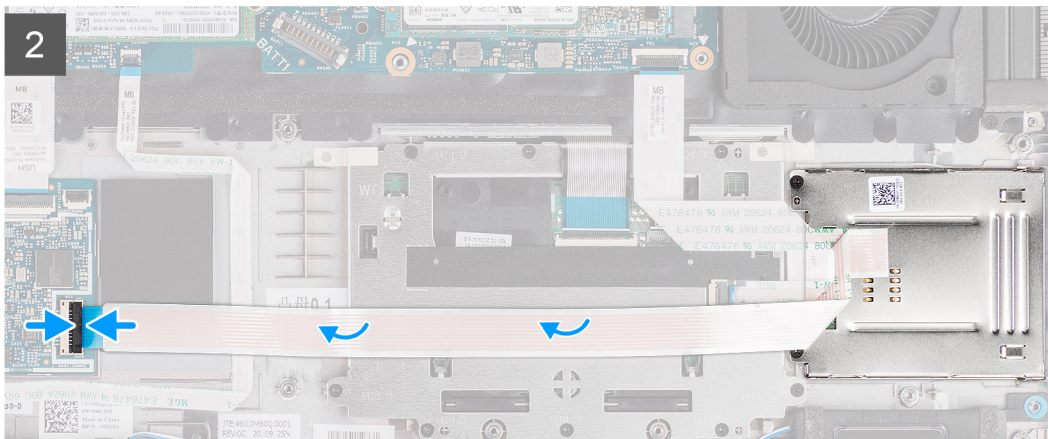
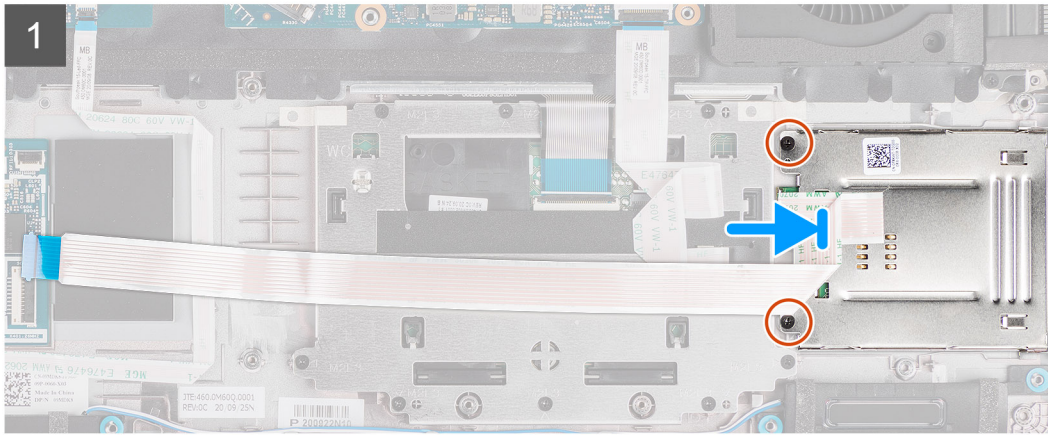
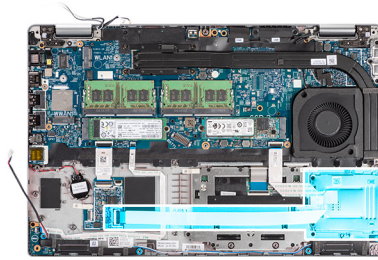

Steps

1. Align and place the smart card reader on the palm-rest assembly.
2. Replace the two screws (M2x3) that secure the smart card reader to the palm-rest assembly.
3. Connect the smart card reader cable to the connector on the USH board.

Next steps

1. Install the [assembly inner frame](#).
2. Install the [battery](#).
3. Install the [WWAN card](#).
4. Install the [WLAN card](#).
5. Install the [base cover](#).
6. Install the [microSD card](#).
7. Install the [SIM card](#).
8. Follow the procedure in [After working inside your computer](#).

Keyboard assembly

Removing the keyboard assembly

Prerequisites

1. Follow the procedure in [Before working inside your computer](#).
2. Remove the [SIM card](#).
3. Remove the [microSD card](#).
4. Remove the [base cover](#).
5. Remove the [WLAN card](#).
6. Remove the [WWAN card](#).
7. Remove the [battery](#).
8. Remove the [system fan](#).
9. Remove the [assembly inner frame](#).
10. Remove the [system board](#).

About this task

The following images indicate the location of the keyboard assembly and provide a visual representation of the removal procedure.



26x
M2x2

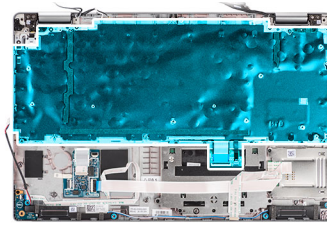

Steps

1. Open the latch and disconnect the backlight cable and the keyboard cable from the connector on the clickpad.
2. Open the plastic tapes on the keyboard assembly to access the keyboard assembly screws.
3. Remove the 26 screws (M2x2) that secure the keyboard assembly to the palm-rest assembly.
4. Remove the keyboard assembly off the palm-rest assembly.

Installing the keyboard assembly

Prerequisites

If you are replacing a component, remove the existing component before performing the installation procedure.

About this task

The following image indicates the location of the keyboard assembly and provides a visual representation of the installation procedure.



26x
M2x2

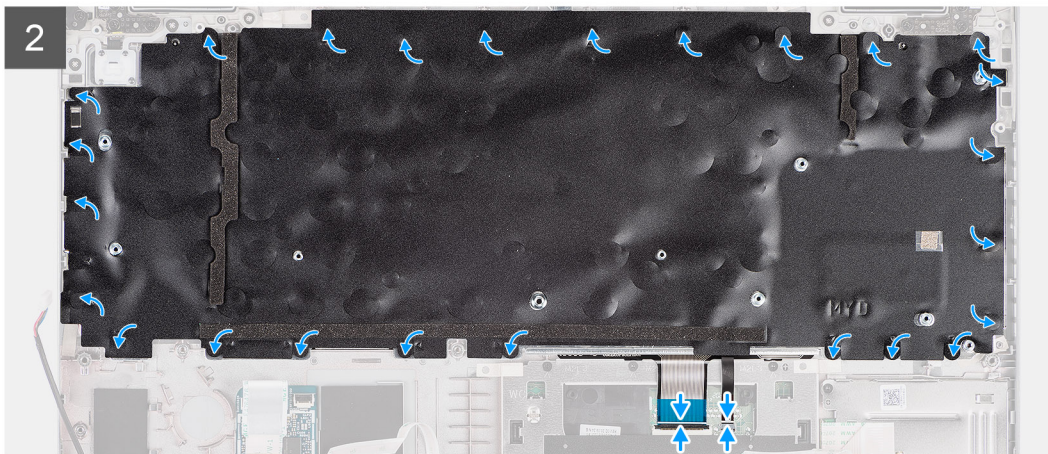
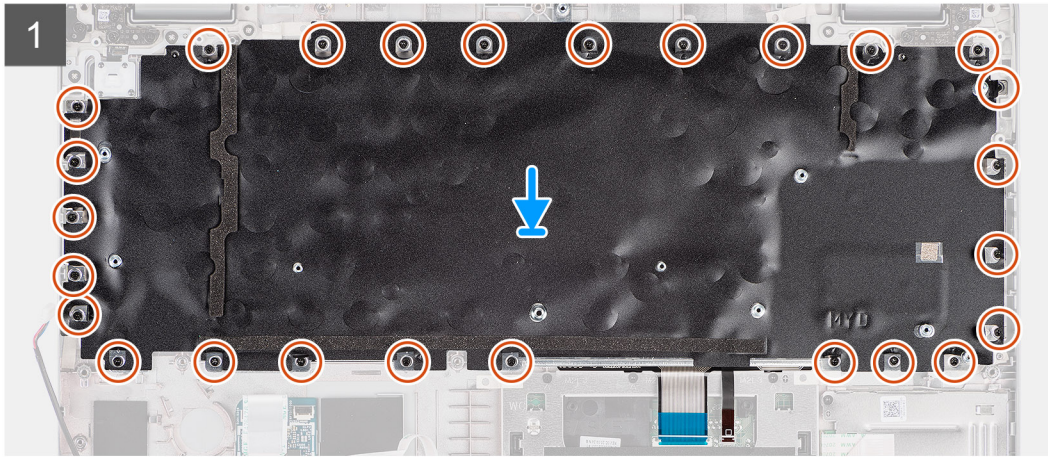
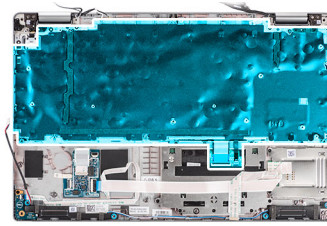

Steps

1. Align and place the keyboard assembly on the palm-rest assembly.
2. Replace the 26 screws (M2x2) that secure the keyboard assembly to the palm-rest assembly.
3. Close the plastic tapes to cover the keyboard assembly screws.
4. Connect the backlight cable and the keyboard cable to the connector on the clickpad.

Next steps

1. Install the [system board](#).
2. Install the [assembly inner frame](#).
3. Install the [system fan](#).
4. Install the [battery](#).
5. Install the [WWAN card](#).
6. Install the [WLAN card](#).
7. Install the [base cover](#).
8. Install the [microSD card](#).
9. Install the [SIM card](#).
10. Follow the procedure in [After working inside your computer](#).

Keyboard bracket

Removing the keyboard bracket

Prerequisites

1. Follow the procedure in [Before working inside your computer](#).
2. Remove the [SIM card](#).
3. Remove the [microSD card](#).
4. Remove the [base cover](#).
5. Remove the [WLAN card](#).
6. Remove the [WWAN card](#).
7. Remove the [battery](#).
8. Remove the [system fan](#).
9. Remove the [assembly inner frame](#).
10. Remove the [system board](#).
11. Remove the [keyboard assembly](#).

About this task

The following images indicate the location of the keyboard bracket and provide a visual representation of the removal procedure.



10x
M2x2



Steps

1. Remove the ten screws (M2x2) that secure the keyboard to the keyboard bracket.
2. Remove the keyboard from the keyboard bracket.

Installing the keyboard bracket

Prerequisites

If you are replacing a component, remove the existing component before performing the installation procedure.

About this task

The following image indicates the location of the keyboard bracket and provides a visual representation of the installation procedure.



10x
M2x2



Steps

1. Align and place the keyboard on the keyboard bracket.
2. Replace the ten screws (M2x2) to secure the keyboard to the keyboard bracket.

Next steps

1. Install the [keyboard assembly](#).
2. Install the [system board](#).
3. Install the [assembly inner frame](#).
4. Install the [system fan](#).
5. Install the [battery](#).
6. Install the [WWAN card](#).
7. Install the [WLAN card](#).
8. Install the [base cover](#).
9. Install the [microSD card](#).
10. Install the [SIM card](#).
11. Follow the procedure in [After working inside your computer](#).

Display assembly

Removing the display assembly

Prerequisites

1. Follow the procedure in [Before working inside your computer](#).
2. Remove the [SIM card](#).
3. Remove the [microSD card](#).
4. Remove the [base cover](#).

- 5. Remove the [WLAN card](#).
- 6. Remove the [WWAN card](#).

About this task

The following images indicate the location of the display assembly and provide a visual representation of the removal procedure.

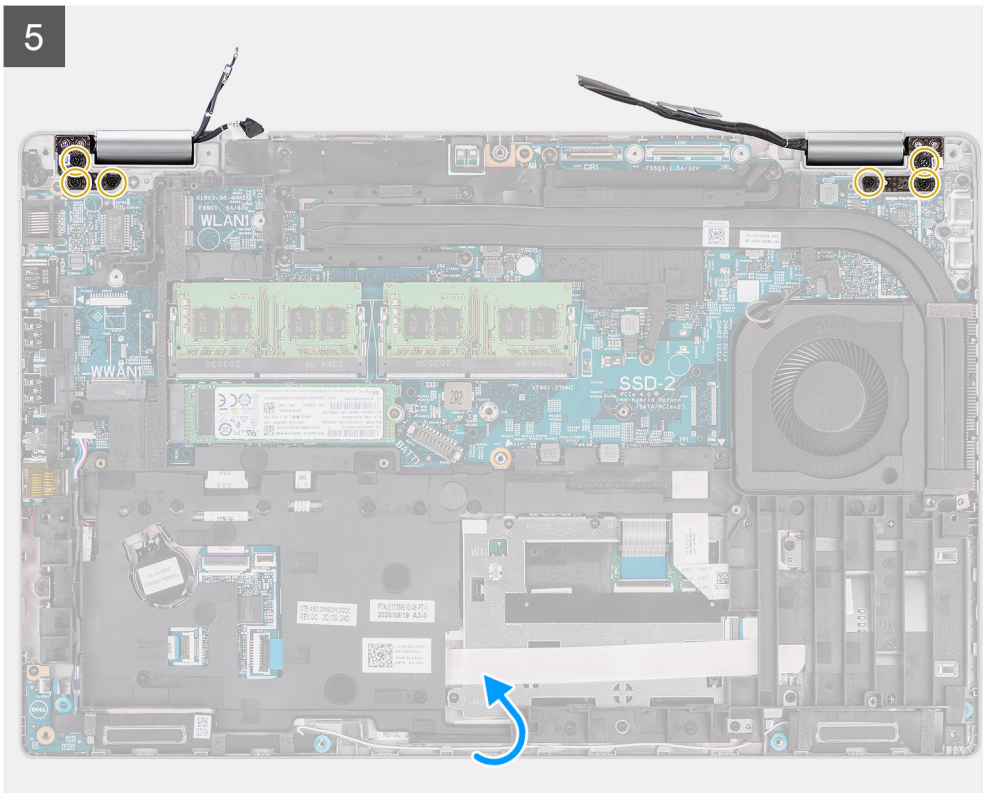
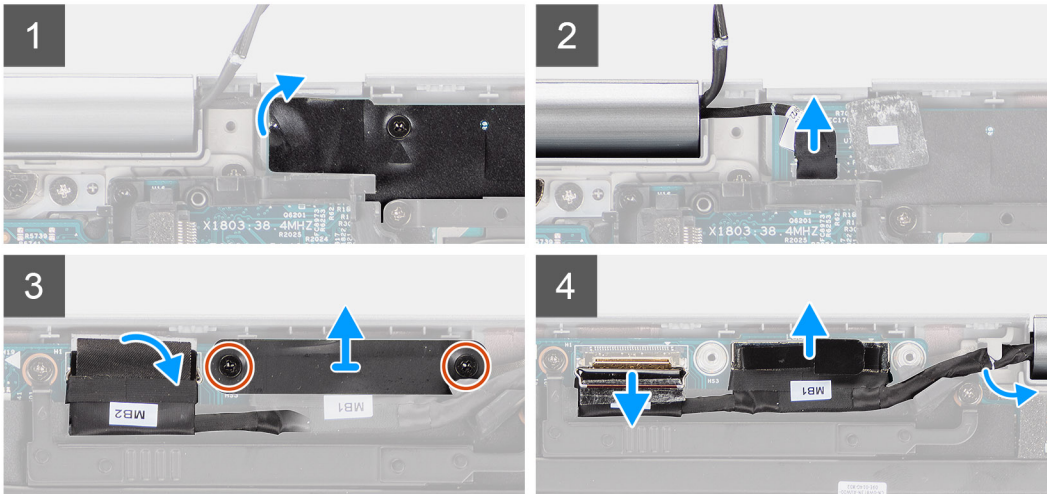
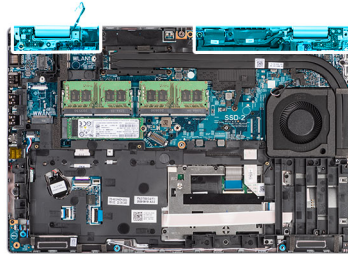
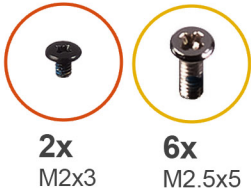

6

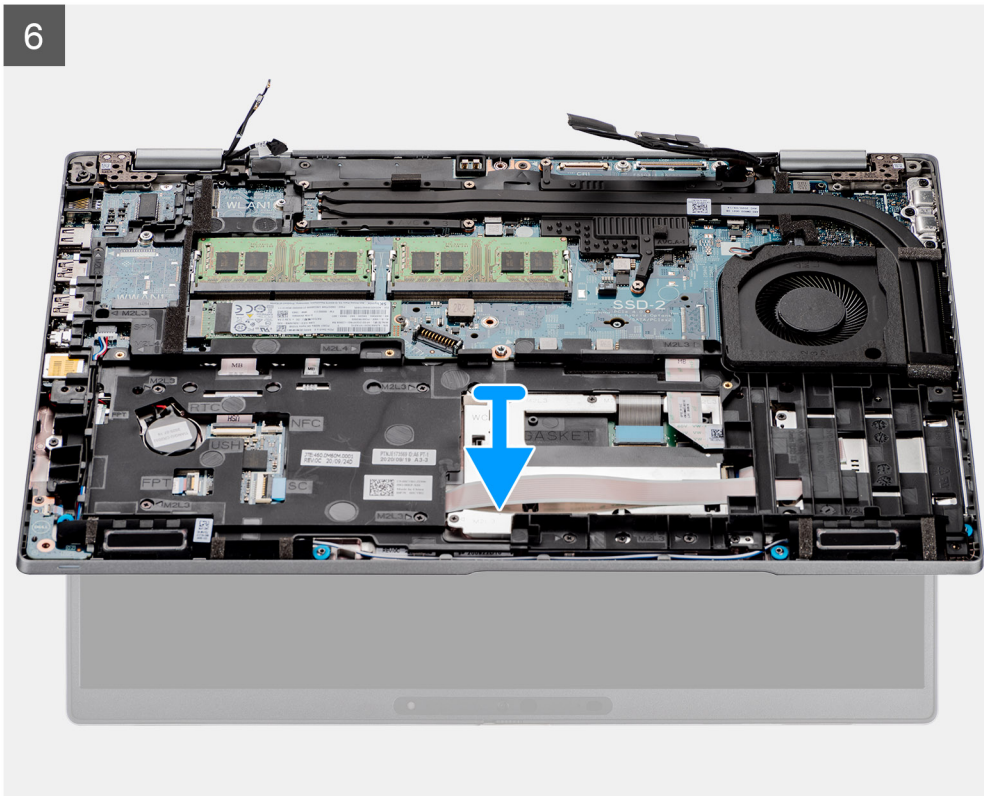

Steps

1. Peel the adhesive tape and disconnect the sensor-board cable from the connector on the system board.
2. Remove the two screws (M2x3) that secure the eDP cable bracket to the system board.
3. Lift the eDP cable bracket away from the system.
4. Peel the tape that secures the display cable to the system board.

5. Using the pull tab, disconnect the display cable from the connector on the system board.
6. Disconnect the eDP cable from the connector on the system board and unroute it from the routing guide.
7. Open the display assembly to a 180 degree and flip over the computer, and then place the computer on a flat surface.
8. Remove the six screws (M2.5x5) that secure the display hinges to the system board.
9. Remove the display assembly off the computer.

Installing the display assembly

Prerequisites

If you are replacing a component, remove the existing component before performing the installation procedure.

About this task

The following image indicates the location of the display assembly and provides a visual representation of the installation procedure.

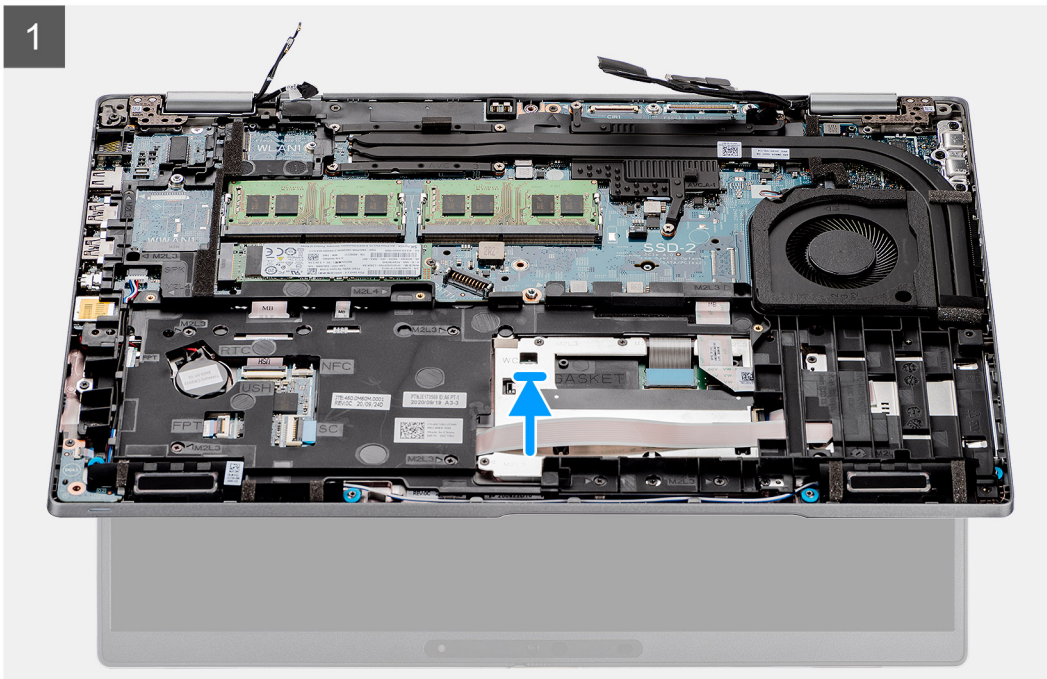
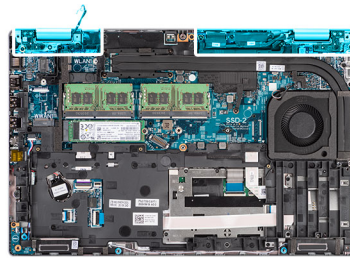
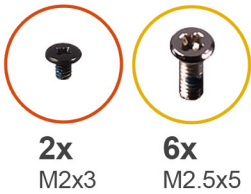

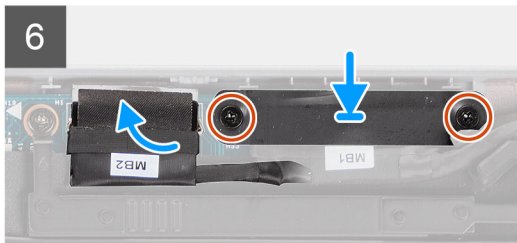
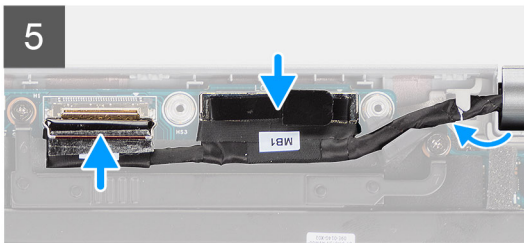
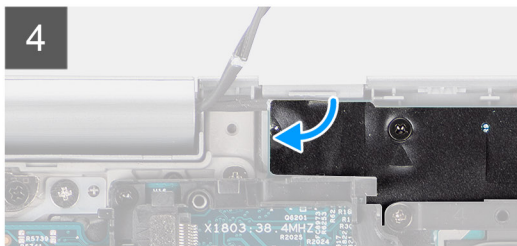
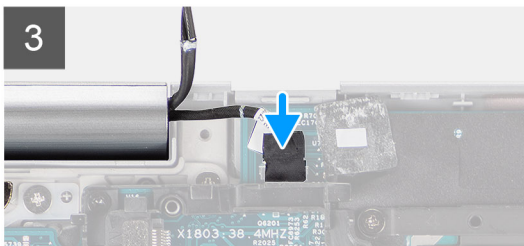
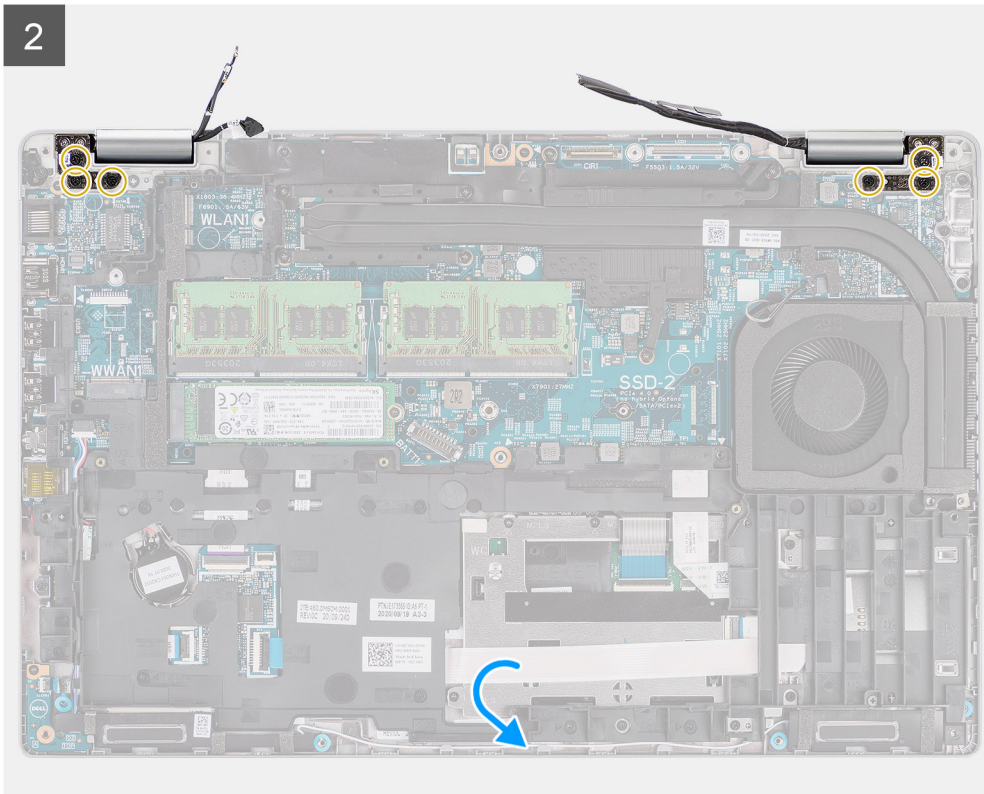

Steps

1. Place the display assembly on the system, and align the screw holes on the display hinges with screw holes on the system board.
2. Replace the six screws (M2.5x5) that secure the display hinges to the system board.
3. Close the display.
4. Connect the sensor-board cable to the connector on the system board and adhere the tape to secure the cable to the system board.
5. Route the display and eDP cable through the routing guide on the system board.
6. Connect the eDP cable to the connector on the system board.
7. Connect the display cable to the connector on the system board.
8. Adhere the tape that secures the display cable to the system board.
9. Align the screw holes on the eDP cable bracket with the screw holes on the system board.
10. Replace the two screws (M2x3) that secure the eDP cable bracket to the system board.

Next steps

1. Install the [WWAN card](#).
2. Install the [WLAN card](#).
3. Install the [base cover](#).
4. Install the [microSD card](#).
5. Install the [SIM card](#).
6. Follow the procedure in [After working inside your computer](#).

Display bezel

Removing the display bezel

Prerequisites

1. Follow the procedure in [Before working inside your computer](#).
2. Remove the [SIM card](#).
3. Remove the [microSD card](#).
4. Remove the [base cover](#).
5. Remove the [display assembly](#).

About this task

The following images indicate the location of the display bezel and provide a visual representation of the removal procedure.

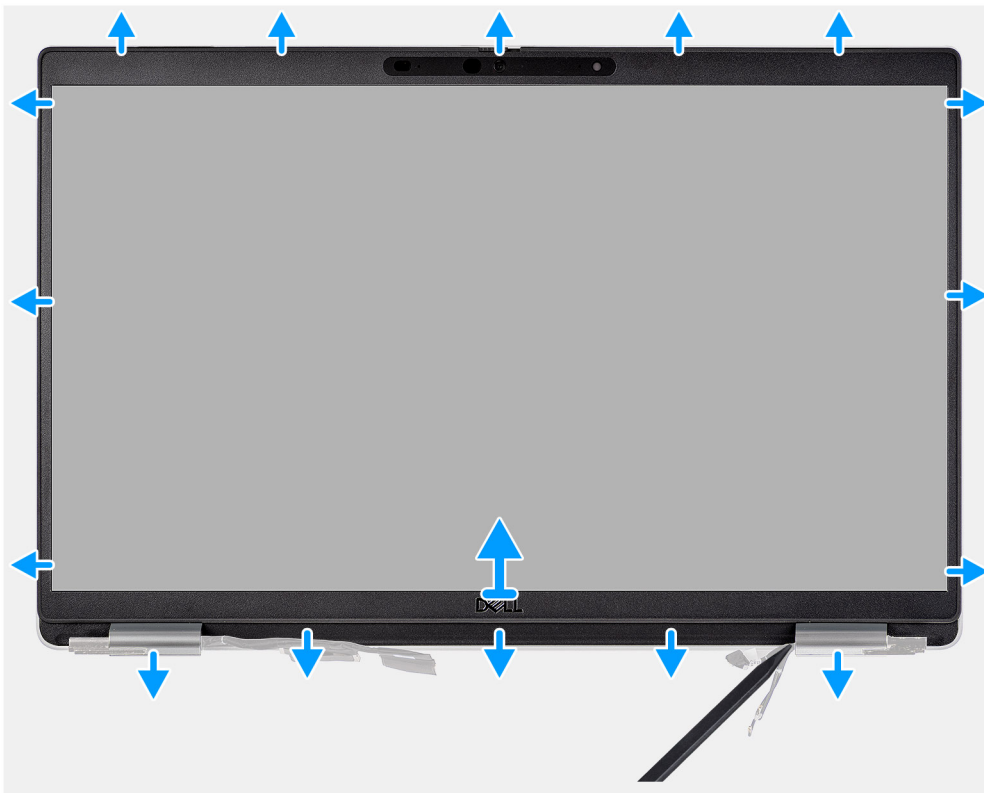

Steps

i **NOTE:** The display bezel is adhered to the display panel with adhesive. Insert a plastic scribe into the recesses near both hinge caps to start the prying process to release the display bezel. Pry along the outside edge of the display bezel and work your way around the entire display bezel until the display bezel is separated from the display cover.

⚠ **CAUTION:** Carefully pry and remove the display bezel to minimize the risk of display panel damages.

1. Using a plastic scribe, pry open the recesses near the left and right hinges on the bottom edge of the display bezel.
2. Carefully work your way around the edges of the display bezel to release it from the display back cover.
3. Lift the display bezel from the display assembly.

Installing the display bezel

Prerequisites

If you are replacing a component, remove the existing component before performing the installation procedure.

About this task

The following image indicates the location of the display bezel and provides a visual representation of the installation procedure.

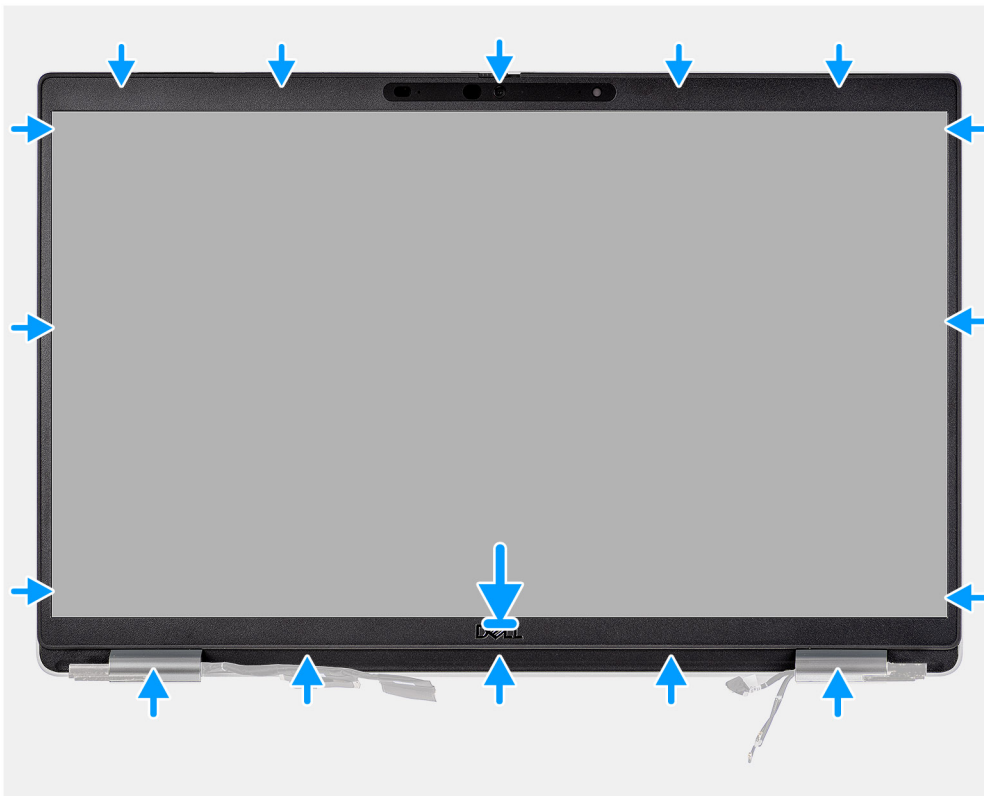

Steps

NOTE: While installing the replacement display bezel for the models that are shipped with a camera, carefully peel off the piece of tape that is used to secure the camera shutter to the replacement display bezel.

CAUTION: You must take extra care when peeling the tape. An abrupt peeling may remove the camera shutter from the display bezel and damage the camera shutter.

1. Align and place the display bezel on the display assembly.
2. Gently snap the display bezel into place.

Next steps

1. Install the [display assembly](#).
2. Install the [base cover](#).
3. Install the [microSD card](#).
4. Install the [SIM card](#).
5. Follow the procedure in [After working inside your computer](#).

Display panel

Removing the display panel

Prerequisites

1. Follow the procedure in [Before working inside your computer](#).
2. Remove the [SIM card](#).
3. Remove the [microSD card](#).
4. Remove the [base cover](#).
5. Remove the [display assembly](#).
6. Remove the [display bezel](#).

About this task

The following images indicate the location of the display panel and provide a visual representation of the removal procedure.



4x
M2.5x3.5



2





Steps

i **NOTE:** The display panel is preassembled with the display brackets as a single service part. Do not pull the Stretch Release (SR) tapes and separate the brackets from the display panel.

1. Remove the four screws (M2.5x3.5) that secure the display panel to the display back cover.

i **NOTE:** While removing the display panel, disengage the display panel tabs from the display cover before flipping it over

2. Lift and open the display panel to access the display cable.

3. Peel the conductive tape on the display cable connector.

4. Open the latch and disconnect the cable from the connector on the display panel.

5. Lift the display panel away from the display back cover.

Installing the display panel

Prerequisites

If you are replacing a component, remove the existing component before performing the installation procedure.

About this task

The following images indicate the location of the display panel and provides a visual representation of the installation procedure.

1





4x
M2.5x3.5



2



Steps

1. Connect the display cable to the connector on the display panel and close the latch.
2. Adhere the conductive tape to secure the display cable to the display panel.
3. Close the display panel and the display back cover to assemble.

i **NOTE:** Ensure that the display panel tabs are inserted into the slots on the display cover.

4. Replace the four screws (M2.5x3.5) to secure the display panel to the display back cover.

Next steps

1. Install the [display bezel](#).
2. Install the [display assembly](#).
3. Install the [base cover](#).
4. Install the [microSD card](#).
5. Install the [SIM card](#).
6. Follow the procedure in [After working inside your computer](#).

Camera/microphone module

Removing the camera/microphone module

Prerequisites

1. Follow the procedure in [Before working inside your computer](#).
2. Remove the [SIM card](#)
3. Remove the [microSD card](#).
4. Remove the [base cover](#).
5. Remove the [display assembly](#).
6. Remove the [display bezel](#).
7. Remove the [display hinges](#).
8. Remove the [display panel](#).

About this task

The following images indicate the location of the camera/microphone module and provide a visual representation of the removal procedure.

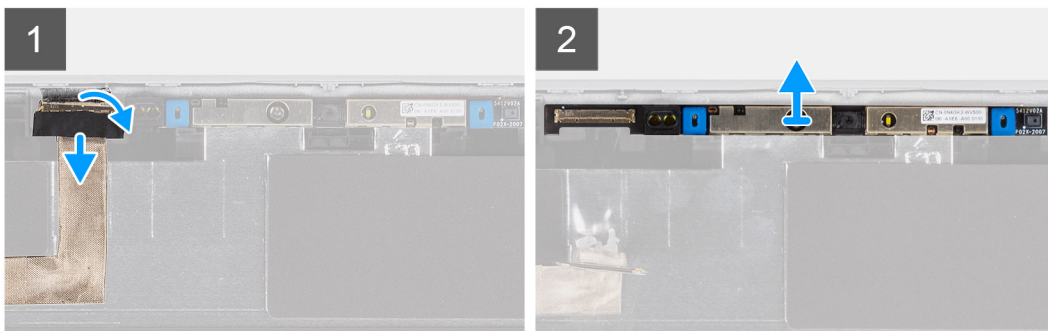
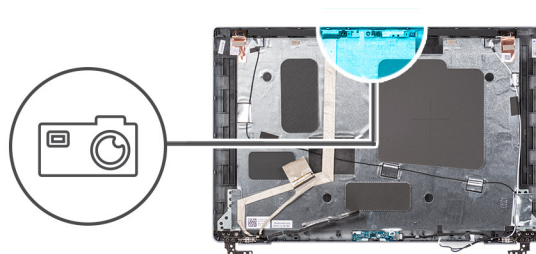

Steps

1. Peel the two conductive tapes that secure the camera/microphone module in place.
2. Disconnect the camera/microphone cable from the connector on the camera/microphone module.
3. Carefully lift the camera/microphone module from the display back cover.

Installing the camera/microphone module

Prerequisites

If you are replacing a component, remove the existing component before performing the installation procedure.

About this task

The following image indicates the location of the camera/microphone module and provides a visual representation of the installation procedure.

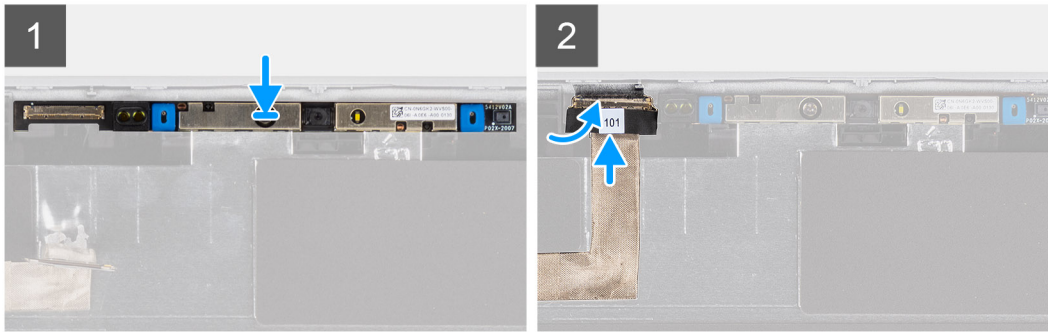
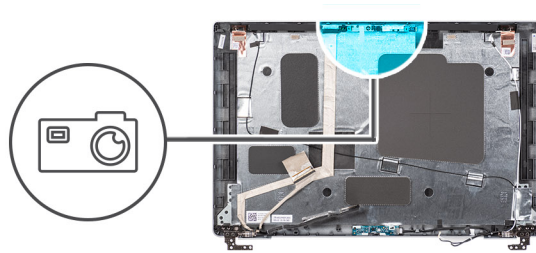

Steps

1. Align and place the camera/microphone module into the slot on the display back cover.
2. Connect the camera/microphone cable to the connector on the camera/microphone module.

Next steps

1. Install the [display panel](#).
2. Install the [display hinges](#).
3. Install the [display bezel](#).
4. Install the [display assembly](#).
5. Install the [base cover](#).
6. Install the [microSD card](#).
7. Install the [SIM card](#).
8. Follow the procedure in [After working inside your computer](#).

eDP/display cable

Removing the eDP/display cable

Prerequisites

1. Follow the procedure in [Before working inside your computer](#).
2. Remove the [SIM card](#)
3. Remove the [microSD card](#).
4. Remove the [base cover](#).
5. Remove the [display assembly](#).
6. Remove the [display bezel](#).
7. Remove the [display panel](#).

About this task

The following images indicate the location of the eDP/display cable and provide a visual representation of the removal procedure.

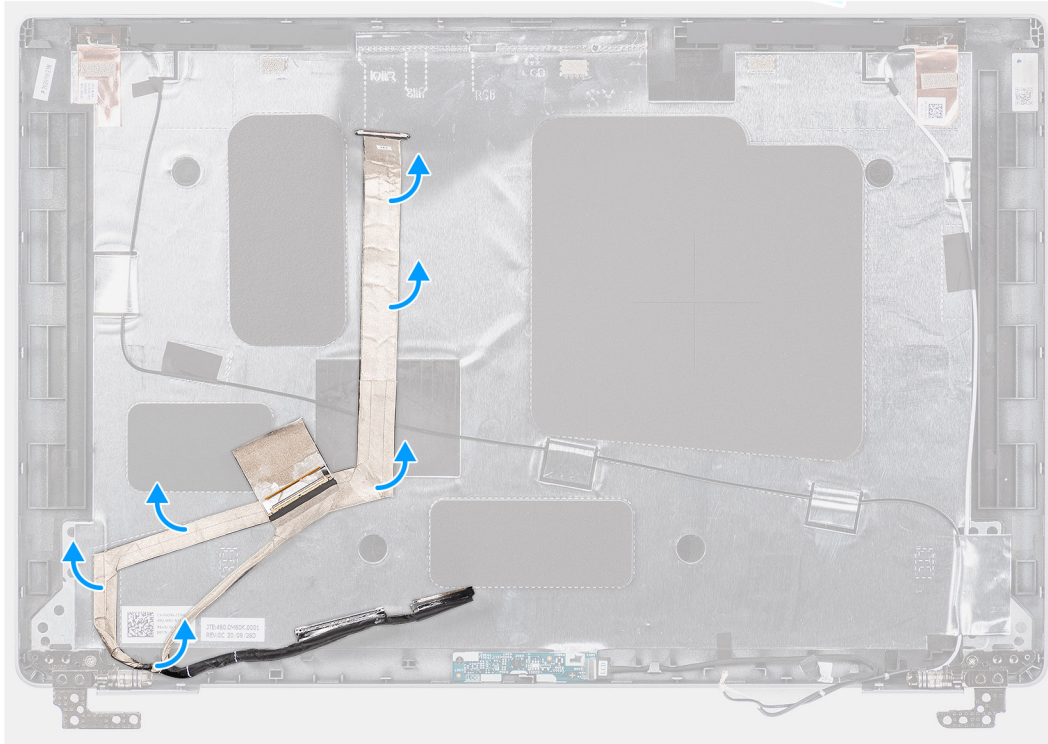
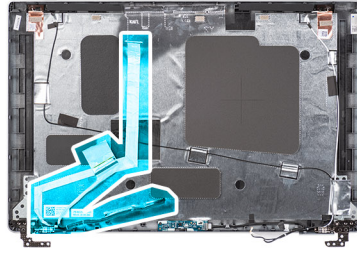

Steps

1. Disconnect the eDP/display cable from the connector on the camera/microphone module.
2. Peel the conductive tape and unroute the eDP/display cable to release it from adhesive and lift the eDP/display cable from the display back cover.

Installing the eDP/display cable

Prerequisites

If you are replacing a component, remove the existing component before performing the installation procedure.

About this task

The following image indicates the location of the eDP/display cable and provides a visual representation of the installation procedure.

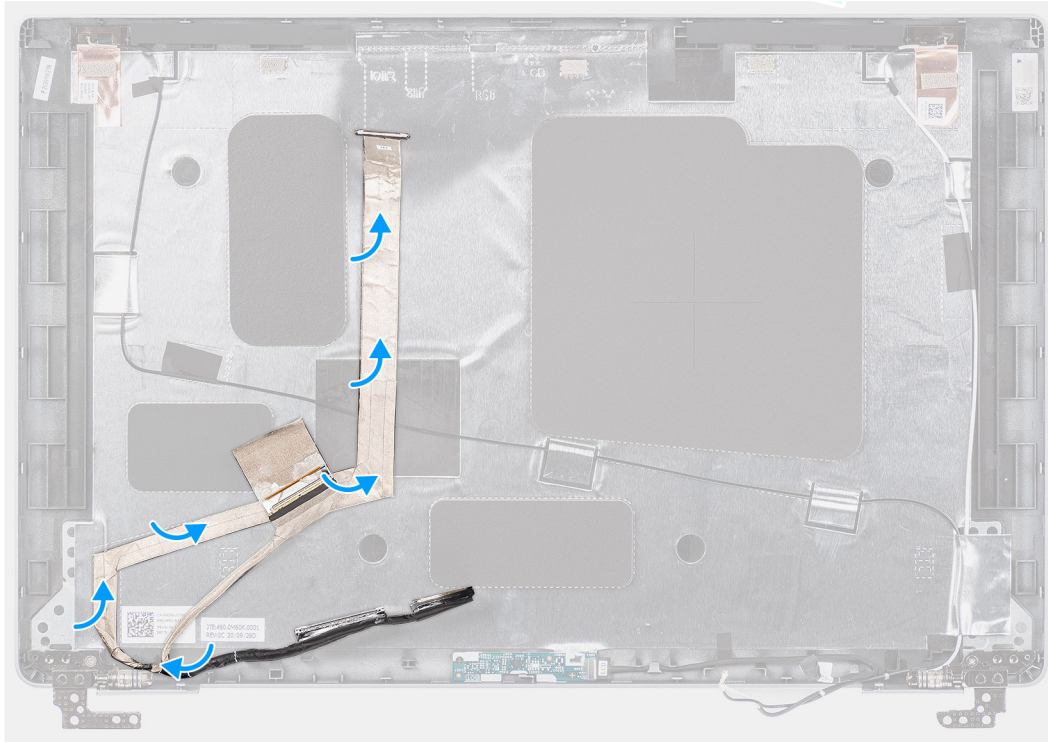
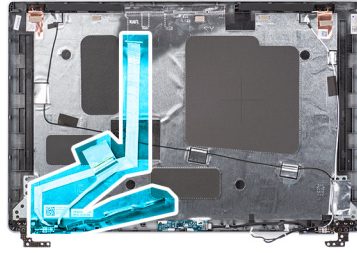

Steps

1. Connect the eDP/display cable to the connector on the camera.
2. Adhere the eDP/display cable to the display back cover.
3. Adhere the conductive tape and route the eDP/display cable to the display back cover.

Next steps

1. Install the [display panel](#).
2. Install the [display bezel](#).
3. Install the [display assembly](#).
4. Install the [base cover](#).
5. Install the [microSD card](#).
6. Install the [SIM card](#).
7. Follow the procedure in [After working inside your computer](#).

Sensor board

Removing the sensor board

Prerequisites

1. Follow the procedure in [Before working inside your computer](#).
2. Remove the [SIM card](#).

3. Remove the [microSD card](#).
4. Remove the [base cover](#).
5. Remove the [display assembly](#).
6. Remove the [display bezel](#).
7. Remove the [display panel](#).

About this task

The following images indicate the location of the sensor board and provide a visual representation of the removal procedure.

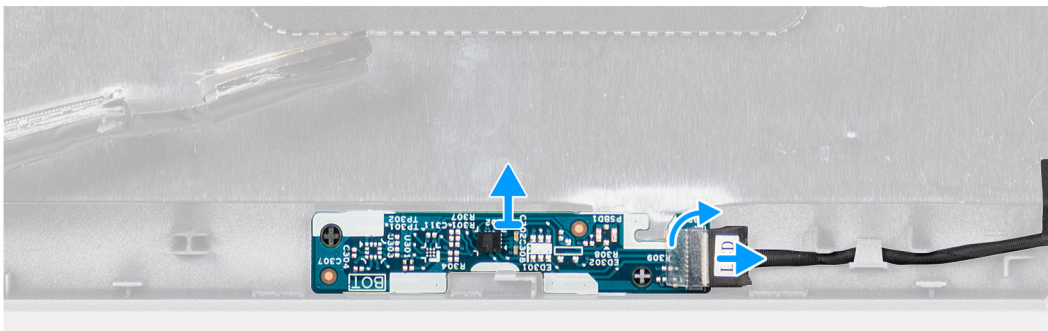
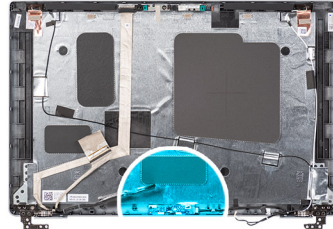

Steps

1. Open the latch and disconnect the display cable from connector on the sensor board.
2. Gently lift the sensor board away from the display back cover.

Installing the sensor board

About this task

The following images indicate the location of the sensor board and provide a visual representation of the removal procedure.

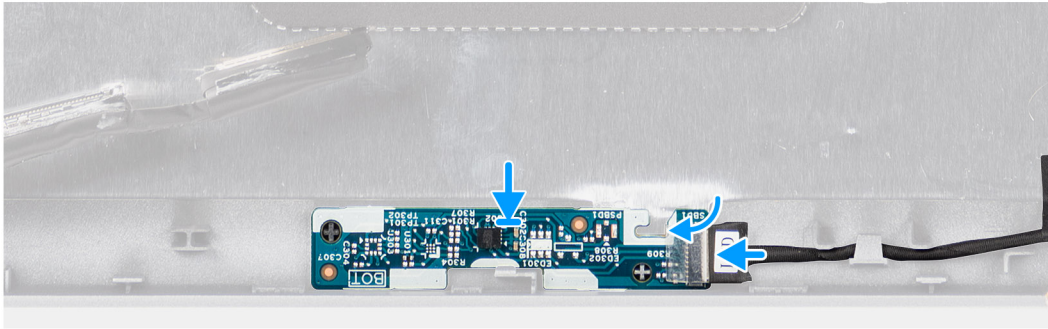
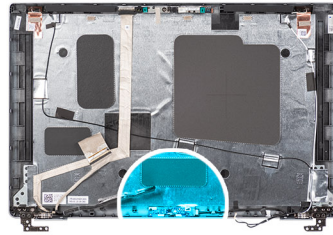

Steps

1. Align and place the sensor board on the display back cover.
2. Connect the display cable to the connector on the sensor board and close the latch.

Next steps

1. Install the [display panel](#).
2. Install the [display bezel](#).
3. Install the [display assembly](#).
4. Install the [base cover](#).
5. Install the [microSD card](#).
6. Install the [SIM card](#).
7. Follow the procedure in [After working inside your computer](#).

Display hinges

Removing the display hinges

Prerequisites

1. Follow the procedure in [Before working inside your computer](#).
2. Remove the [SIM card](#).
3. Remove the [microSD card](#).
4. Remove the [base cover](#).
5. Remove the [display assembly](#).
6. Remove the [display bezel](#).
7. Remove the [display panel](#).

About this task

The following images indicate the location of the display hinges and provide a visual representation of the removal procedure.



2x
M2.5x3.5

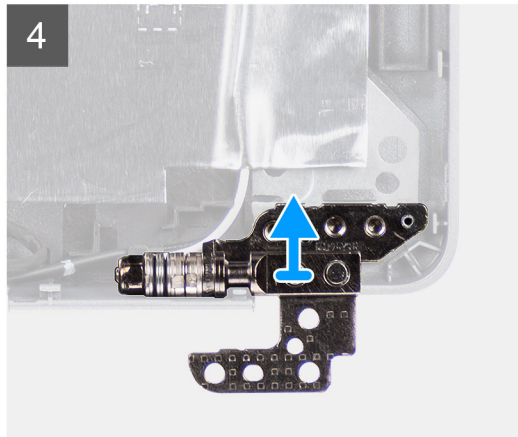
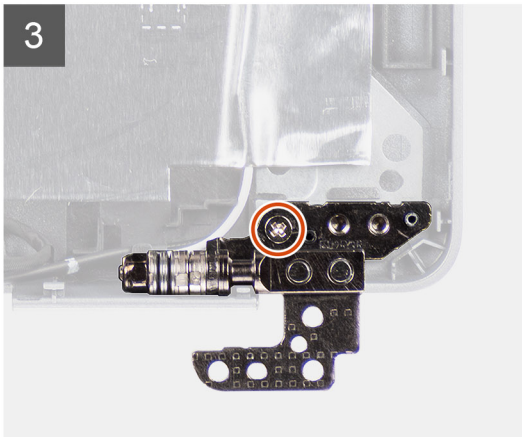
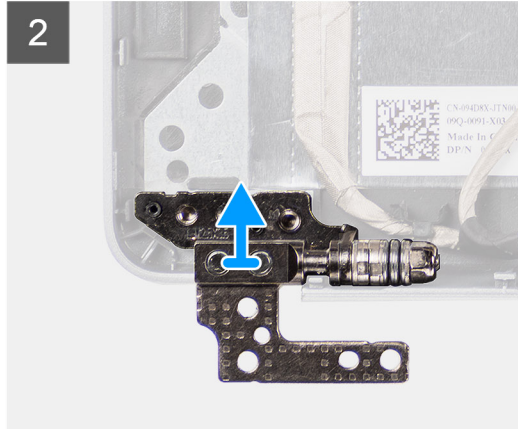
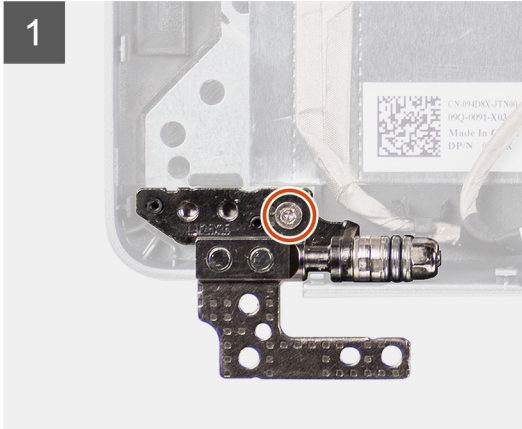
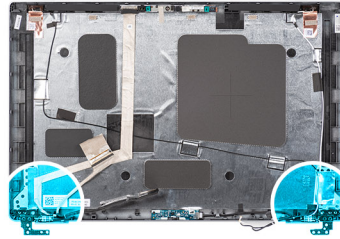

Steps

1. Remove the single screw (M2x3.5) that secures the right hinge to the display back cover.
2. Lift and remove the right hinge from the display back cover.
3. Remove the single screw (M2x3.5) that secures the left hinge to the display back cover.
4. Lift and remove the left hinge from the display back cover.

Installing the display hinges

Prerequisites

If you are replacing a component, remove the existing component before performing the installation procedure.

About this task

The following images indicate the location of the display hinges and provides a visual representation of the installation procedure.



2x
M2.5x3.5

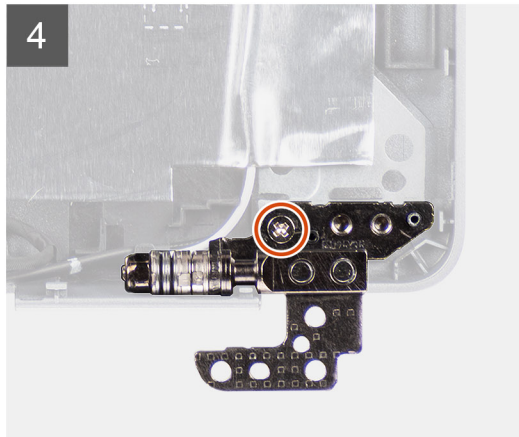
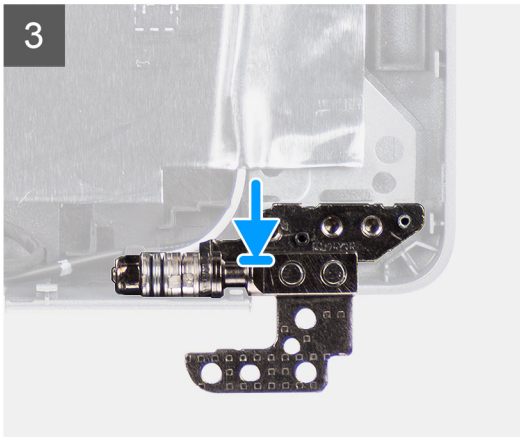
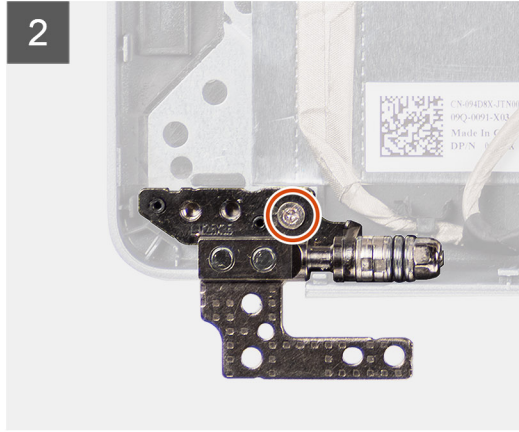
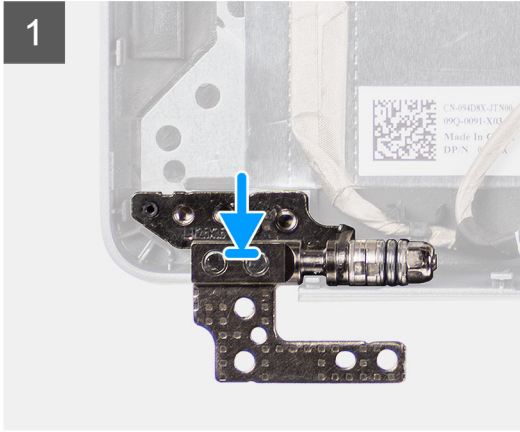
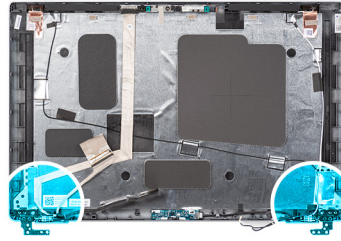

Steps

1. Align the screw hole on the left hinge with the screw hole on the display back cover.
2. Replace the single screw (M2x3.5) to secure the left hinge to the display back cover.
3. Align the screw hole on the right hinge with the screw hole on the display back cover.
4. Replace the single screw (M2x3.5) to secure the right hinge to the display back cover.

Next steps

1. Install the [display panel](#).
2. Install the [display bezel](#).
3. Install the [display assembly](#).
4. Install the [base cover](#).
5. Install the [microSD card](#).
6. Install the [SIM card](#).
7. Follow the procedure in [After working inside your computer](#).

Display back cover

Removing the display back cover

Prerequisites

1. Follow the procedure in [Before working inside your computer](#).
2. Remove the [SIM card](#).
3. Remove the [microSD card](#).
4. Remove the [base cover](#).
5. Remove the [display assembly](#).
6. Remove the [display bezel](#).
7. Remove the [display panel](#).
8. Remove the [camera/microphone module](#).
9. Remove the [eDP/display cable](#).
10. Remove the [sensor board](#).
11. Remove the [display hinges](#).

About this task

The following images indicate the location of the display back cover and provide a visual representation of the removal procedure.

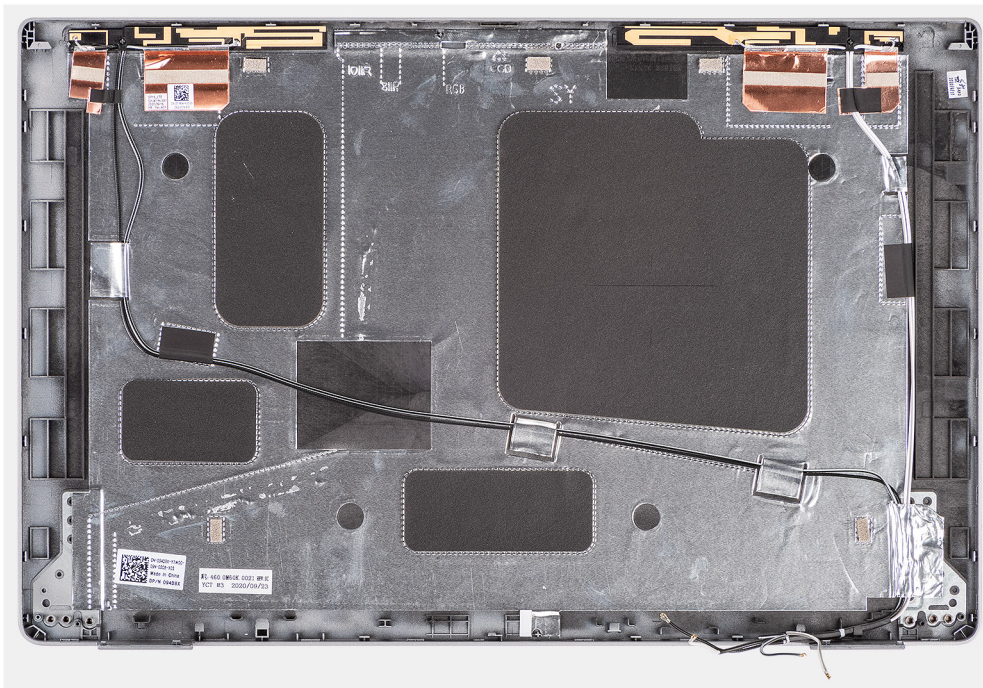

Steps

After performing the steps in the pre-requisites, we are left with the display back cover.

Installing the display back cover

Prerequisites

If you are replacing a component, remove the existing component before performing the installation procedure.

About this task

The following images indicate the location of the display back cover and provides a visual representation of the installation procedure.

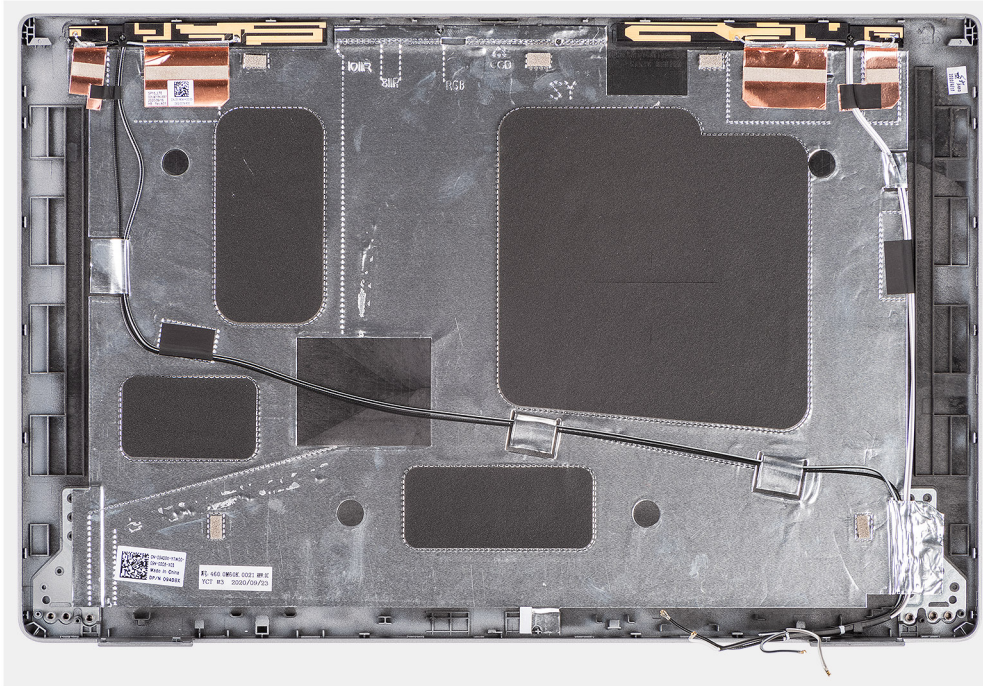

Steps

Place the display back cover on a flat surface.

Next steps

1. Install the [display hinges](#).
2. Install the [sensor board](#).
3. Install the [eDP/display cable](#).
4. Install the [camera/microphone module](#).
5. Install the [display panel](#).
6. Install the [display bezel](#).
7. Install the [display assembly](#).
8. Install the [base cover](#).
9. Install the [microSD card](#).
10. Install the [SIM card](#).
11. Follow the procedure in [After working inside your computer](#).

Dummy SIM-card slot filler

Removing the dummy SIM-card slot filler

Prerequisites

1. Follow the procedure in [Before working inside your computer](#).
2. Remove the [SIM card](#).
3. Remove the [microSD card](#).
4. Remove the [base cover](#).
5. Remove the [WLAN card](#).
6. Remove the [WWAN card](#).

7. Remove the [assembly Inner frame](#).
8. Remove the [system fan](#).
9. Remove the [battery](#).
10. Remove the [system board](#).
11. Remove the [smart card reader](#).
12. Remove the [keyboard assembly](#).
13. Remove the [display assembly](#).

About this task

i NOTE: For models shipped with WLAN antennas only, the dummy SIM-card slot filler is a separate service part and is not included with replacement palm rest. As a result, the dummy SIM-card slot filler must be removed and then reinstalled when replacing the palm-rest assembly.

The following image indicates the dummy SIM-card slot filler and provides a visual representation of the dummy SIM-card slot filler removal procedure.

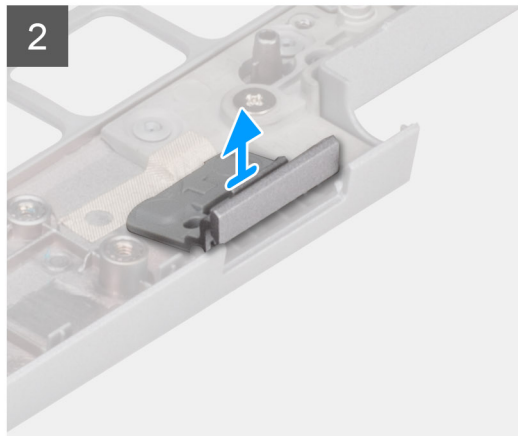
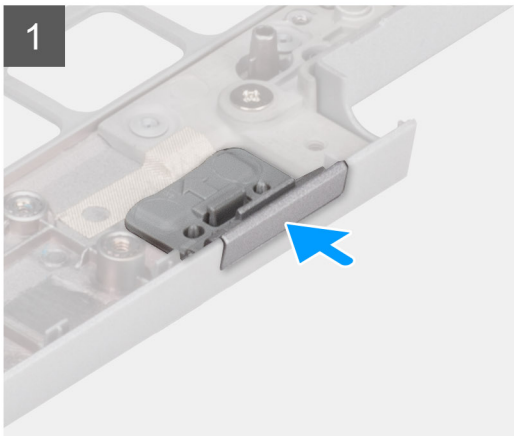
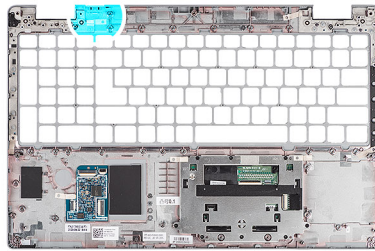

Steps

1. Push the dummy SIM-card slot filler from the top side of the palm-rest assembly.
2. Gently lift the dummy SIM-card slot filler out of the palm-rest assembly.

Installing the dummy SIM-card slot filler

Prerequisites

If you are replacing a component, remove the necessary component before the installation procedure.

About this task

The following image indicates the location of the dummy SIM-card slot filler and provides a visual representation of the dummy SIM-card slot filler installation procedure.

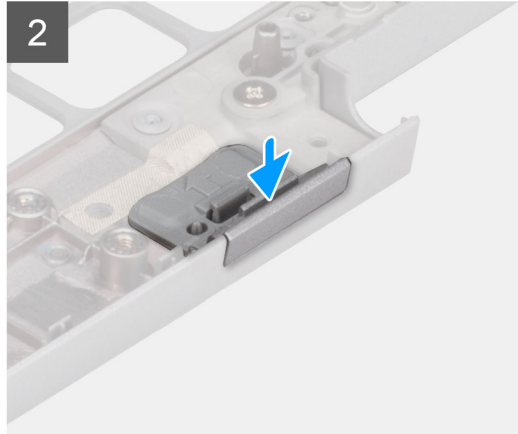
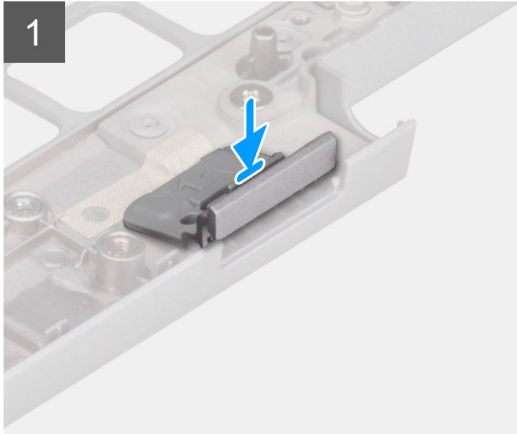
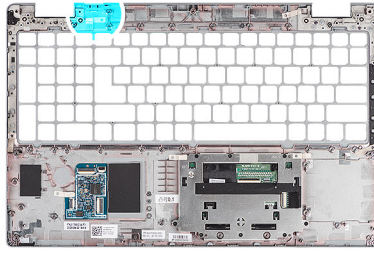

Steps

1. Place the dummy SIM-card slot filler into its compartment on the palm rest.
i **NOTE:** Ensure that the dummy SIM-card slot filler is aligned with the ribs on the palm-rest assembly.
2. Press the dummy SIM-card slot filler until it clicks into place and ensure it fits securely into the SIM card slot.

Next steps

1. Install the [display assembly](#).
2. Install the [keyboard assembly](#).
3. Install the [smart card reader](#).
4. Install the [system board](#).
5. Install the [battery](#).
6. Install the [system fan](#).
7. Install the [assembly inner frame](#).
8. Install the [WWAN card](#).
9. Install the [WLAN card](#).
10. Install the [base cover](#).
11. Install the [microSD card](#).
12. Install the [SIM card](#).
13. Follow the procedure in [After working inside your computer](#).

Palm-rest assembly

Removing the palm-rest assembly

Prerequisites

1. Follow the procedure in [Before working inside your computer](#).
2. Remove the [SIM card](#).
3. Remove the [microSD card](#).
4. Remove the [base cover](#).

5. Remove the [WLAN card](#).
6. Remove the [WWAN card](#).
7. Remove the [assembly Inner frame](#).
8. Remove the [system fan](#).
9. Remove the [battery](#).
10. Remove the [system board](#).
11. Remove the [smart card reader](#).
12. Remove the [keyboard assembly](#).
13. Remove the [display assembly](#).
14. Remove the [dummy SIM-card slot filler](#) (only for non-WWAN configuration).

NOTE: For models with smart card reader configuration, the smart card reader is preinstalled in the replacement palm-rest assembly.

About this task

The following image indicates the palm-rest assembly and provides a visual representation of the removal procedure.

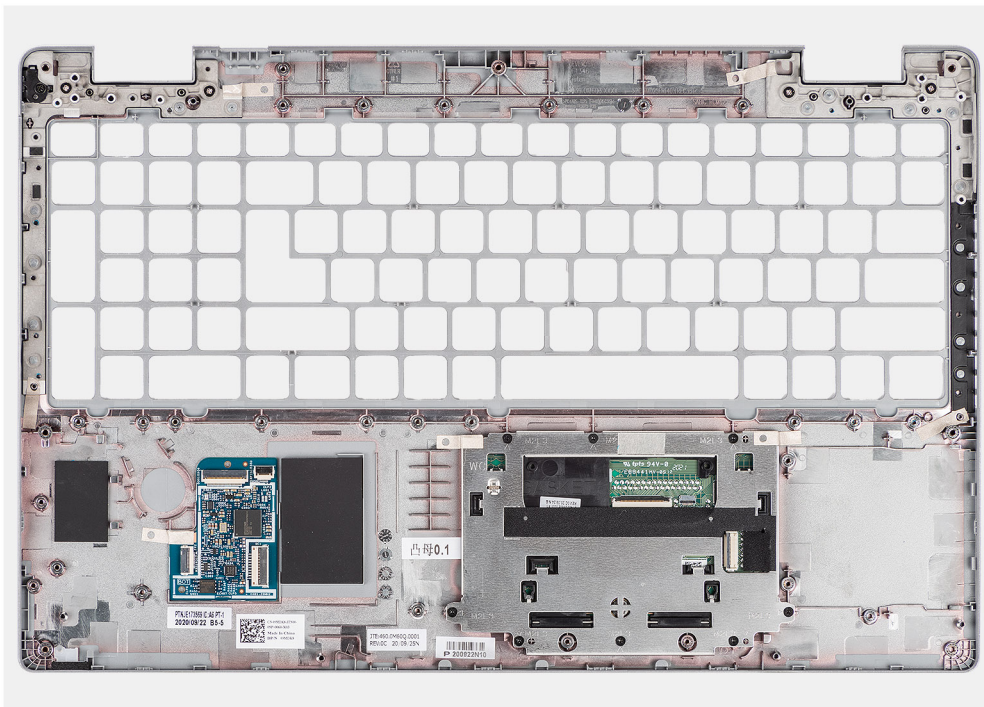

Steps

After performing the steps in the pre-requisites, we are left with the palm-rest assembly.

Installing the palm-rest assembly

Prerequisites

If you are replacing a component, remove the existing component before performing the installation procedure.

About this task

The following image indicates the palm-rest assembly and provides a visual representation of the installation procedure.

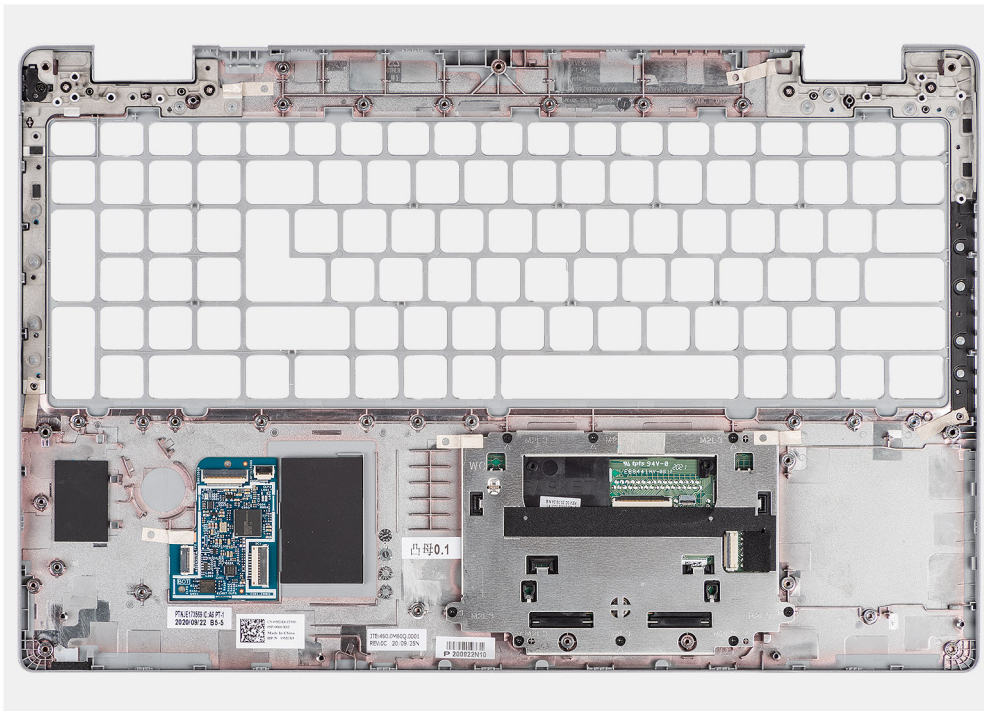

Steps

Place the palm-rest assembly on a flat surface.

Next steps

1. Install the [dummy SIM-card slot filler](#) (only for non-WWAN configuration).
2. Install the [display assembly](#).
3. Install the [keyboard assembly](#)
4. Install the [smart card reader](#).
5. Install the [system board](#).
6. Install the [battery](#).
7. Install the [system fan](#).
8. Install the [assembly inner frame](#).
9. Install the [WWAN card](#).
10. Install the [WLAN card](#).
11. Install the [base cover](#).
12. Install the [microSD card](#).
13. Install the [SIM card](#).
14. Follow the procedure in [After working inside your computer](#).

Software

This chapter details the supported operating systems along with instructions on how to install the drivers.

Topics:



- [Operating system](#)
- [Downloading the drivers](#)

Operating system

- Windows 10 Pro, 64-bit
- Windows 10 Home, 64-bit
- Ubuntu Linux 20.04 LTS, 64-bit

Downloading the drivers

Steps

1. Turn on your computer.
2. Go to www.dell.com/support.
3. Enter the Service Tag of your computer, and then click **Submit**.
 **NOTE:** If you do not have the Service Tag, use the auto-detect feature or manually browse for your computer model.
4. Click **Drivers & downloads**.
5. Click the **Detect Drivers** button.
6. Review and agree to the Terms and Conditions to use **SupportAssist**, then click **Continue**.
7. If necessary, your computer starts to download and install **SupportAssist**.
 **NOTE:** Review on-screen instructions for browser-specific instructions.
8. Click **View Drivers for My System**.
9. Click **Download and Install** to download and install all driver updates detected for your computer.
10. Select a location to save the files.
11. If prompted, approve requests from **User Account Control** to make changes on the system.
12. The application installs all drivers and updates identified.
 **NOTE:** Not all files can be installed automatically. Review the installation summary to identify if manual installation is necessary.
13. For manual download and installation, click **Category**.
14. From the drop-down list, select the preferred driver.
15. Click **Download** to download the driver for your computer.
16. After the download is complete, navigate to the folder where you saved the driver file.
17. Double-click the driver file icon and follow the instructions on the screen to install the driver.

System setup

CAUTION: Unless you are an expert computer user, do not change the settings in the BIOS Setup program. Certain changes can make your computer work incorrectly.

NOTE: Before you change BIOS Setup program, it is recommended that you write down the BIOS Setup program screen information for future reference.

Use the BIOS Setup program for the following purposes:

- Get information about the hardware installed in your computer, such as the amount of RAM and the size of the hard drive.
- Change the system configuration information.
- Set or change a user-selectable option, such as the user password, type of hard drive installed, and enabling or disabling base devices.

Topics:

- [BIOS overview](#)
- [Entering BIOS setup program](#)
- [Navigation keys](#)
- [One time boot menu](#)
- [Boot Sequence](#)
- [System setup options](#)
- [Updating the BIOS](#)
- [System and setup password](#)
- [Clearing BIOS \(System Setup\) and System passwords](#)

BIOS overview

The BIOS manages data flow between the computer's operating system and attached devices such as hard disk, video adapter, keyboard, mouse, and printer.

Entering BIOS setup program

About this task

Turn on (or restart) your computer and press F2 immediately.

Navigation keys

NOTE: For most of the System Setup options, changes that you make are recorded but do not take effect until you restart the system.

| Keys | Navigation |
|-------------------|--|
| Up arrow | Moves to the previous field. |
| Down arrow | Moves to the next field. |
| Enter | Selects a value in the selected field (if applicable) or follow the link in the field. |
| Spacebar | Expands or collapses a drop-down list, if applicable. |
| Tab | Moves to the next focus area. |

Keys

Navigation

Esc Moves to the previous page until you view the main screen. Pressing Esc in the main screen displays a message that prompts you to save any unsaved changes and restarts the system.

One time boot menu

To enter **one time boot menu**, turn on your computer, and then press F12 immediately.

NOTE: It is recommended to shutdown the computer if it is on.

The one-time boot menu displays the devices that you can boot from including the diagnostic option. The boot menu options are:

- Removable Drive (if available)
- STXXXX Drive (if available)
NOTE: XXX denotes the SATA drive number.
- Optical Drive (if available)
- SATA Hard Drive (if available)
- Diagnostics

The boot sequence screen also displays the option to access the System Setup screen.

Boot Sequence

Boot Sequence allows you to bypass the System Setup–defined boot device order and boot directly to a specific device (for example: optical drive or hard drive). During the Power-on Self-Test (POST), when the Dell logo appears, you can:

- Access System Setup by pressing F2 key
- Bring up the one-time boot menu by pressing F12 key.

The one-time boot menu displays the devices that you can boot from including the diagnostic option. The boot menu options are:

UEFI only:

- Windows Boot Manager
- UEFI RST PC SN730 NVMe 1024GB 20234D802529
- UEFI PXEv4 (MAC:8C47BE3E622C)
- ONBOARD NIC (IPV6)
- ONBOARD NIC (IPV4)

System setup options

NOTE: Depending on your computer and its installed devices, the items listed in this section may or may not appear.

Table 4. System setup options—System information menu

| Overview | |
|-----------------------|--|
| Precision 3560 | |
| BIOS Version | Displays the BIOS version number. |
| Service Tag | Displays the Service Tag of the computer. |
| Asset Tag | Displays the Asset Tag of the computer. |
| Manufacture Date | Displays the manufacture date of the computer. |
| Ownership Date | Displays the ownership date of the computer. |
| Express Service Code | Displays the express service code of the computer. |

Table 4. System setup options—System information menu (continued)

| Overview | |
|-------------------------------|--|
| Ownership Tag | Displays the Ownership Tag of the computer. |
| Signed Firmware Update | Displays whether the Signed Firmware Update is enabled on your computer. |
| Battery Information | |
| Primary | Displays that battery is primary. |
| Battery Level | Displays the battery level of the computer. |
| Battery State | Displays the battery state of the computer. |
| Health | Displays the battery health of the computer. |
| AC Adapter | Displays whether the AC adapter is connected or not. |
| Processor Information | |
| Processor Type | Displays the processor type. |
| Maximum Clock Speed | Displays the maximum processor clock speed. |
| Minimum Clock Speed | Displays the minimum processor clock speed. |
| Current Clock Speed | Displays the current processor clock speed. |
| Core Count | Displays the number of cores on the processor. |
| Processor ID | Displays the processor identification code. |
| Processor L2 Cache | Displays the processor L2 Cache size. |
| Processor L3 Cache | Displays the processor L3 Cache size. |
| Microcode Version | Displays the microcode version. |
| Intel Hyper-Threading Capable | Displays whether the processor is Hyper-Threading (HT) capable. |
| 64-Bit Technology | Displays whether 64-bit technology is used. |
| Memory Information | |
| Memory Installed | Displays the total computer memory installed. |
| Memory Available | Displays the total computer memory available. |
| Memory Speed | Displays the memory speed. |
| Memory Channel Mode | Displays single or dual channel mode. |
| Memory Technology | Displays the technology used for the memory. |
| DIMM_SLOT B | Displays the DIMM B memory size. |
| DIMM_SLOT A | Displays the DIMM A memory size. |
| Devices Information | |
| Panel Type | Displays the Panel Type of the computer. |
| Video Controller | Displays the video controller type of the computer. |
| Video Memory | Displays the video memory information of the computer. |
| Wi-Fi Device | Displays the wireless device information of the computer. |
| Native Resolution | Displays the native resolution of the computer. |
| Video BIOS Version | Displays the video BIOS version of the computer. |
| Audio Controller | Displays the audio controller information of the computer. |
| Bluetooth Device | Displays the Bluetooth device information of the computer. |
| LOM MAC Address | Displays the LAN On Motherboard (LOM) MAC address of the computer. |
| Pass Through MAC Address | Displays the pass through MAC address of the computer. |

Table 4. System setup options—System information menu (continued)

| Overview | |
|-----------------|--|
| Cellular Device | Displays the M.2 PCIe SSD information of the computer. |

Table 5. System setup options—Boot Configuration menu

| Boot Configuration | |
|-------------------------------|--|
| Boot Sequence | |
| Boot mode | Displays the boot mode. |
| Boot Sequence | Displays the boot sequence. |
| Secure Digital (SD) Card Boot | Enable or disable the SD card read-only boot. By default, the Secure Digital (SD) Card Boot option is not enabled. |
| Secure Boot | |
| Enable Secure Boot | Enable or disable the secure boot feature. By default, the option is not enabled. |
| Secure Boot Mode | Enable or disable to change the secure boot mode options. By default, the Deployed Mode is enabled. |
| Expert Key Management | |
| Enable Custom Mode | Enable or disable custom mode. By default, the custom mode option is not enabled. |
| Custom Mode Key Management | Select the custom values for expert key management. |

Table 6. System setup options—Integrated Devices menu

| Integrated Devices | |
|--|--|
| Date/Time | Displays the current date in MM/DD/YYYY format and current time in HH:MM:SS AM/PM format. |
| Camera | Enables or disable the camera. By default, the Enable Camera option is selected |
| Audio | |
| Enable Audio | Enable or disable the integrated audio controller. By default, all the options are enabled. |
| USB/Thunderbolt Configuration | <ul style="list-style-type: none"> Enable or disable booting from USB mass storage devices connected to external USB ports. By default, the Enable External USB Ports option is enabled. Enable or disable booting from USB mass storage devices such as external hard drive, optical drive, and USB drive. By default, the Enable USB Boot Support option is enabled. |
| Enable Thunderbolt Technology Support | Enable or disable the associated ports and adapters. By default, the Enable Thunderbolt Technology Support option is selected. |
| Enable Thunderbolt Boot Support | Enable or disable the Thunderbolt adapter peripheral device and USB devices connected to the Thunderbolt adapter to be used during BIOS Pre-boot. By default, the Enable Thunderbolt Boot Support option is disabled. |

Table 6. System setup options—Integrated Devices menu (continued)

| Integrated Devices | |
|--|--|
| Enable Thunderbolt (and PCIe behind TBT) pre-boot modules | <p>Enable or disable the PCIe devices that are connected through a Thunderbolt adapter to execute the PCIe devices UEFI Option ROM (if present) during pre-boot.</p> <p>By default, the Enable Thunderbolt (and PCIe behind TBT) pre-boot modules option is disabled.</p> |
| Disable USB4 PCIE Tunneling | <p>Disable the USB4 PCIE Tunneling option.</p> <p>By default, the option is disabled.</p> |
| Video/Power only on Type-C Ports | <p>Enable or disable the Type-C port functionality to video or only power.</p> <p>By default, the Video/Power only on Type-C Ports option is disabled.</p> |
| Type-C Dock Override | <p>Enables to use connected Type-C Dell Dock to provide data stream with external USB ports disabled. When Type-C Dock override is enabled, the Video/Audio/Lan submenu is activated.</p> <p>By default, the Type-C Dock Override option is enabled.</p> |
| Video | <p>Enable or disable the usage of video on Dell Dock external ports.</p> <p>By default, the Video option is disabled.</p> |
| Audio | <p>Enable or disable the usage of audio on Dell Dock external ports.</p> <p>By default, the Audio option is enabled.</p> |
| Lan | <p>Enable or disable the usage of LAN on Dell Dock external ports.</p> <p>By default, the Lan option is enabled.</p> |
| Miscellaneous Devices | <p>Enable or disable Fingerprint Reader device.</p> <p>By default, the Enable Fingerprint Reader Device option is enabled.</p> |
| Unobtrusive Mode | |
| Enable Unobtrusive Mode | <p>Enable or disable all the computer light and sound.</p> <p>By default, the Enable Unobtrusive Mode option is disabled.</p> |

Table 7. System setup options—Storage menu

| Storage | |
|--------------------------|---|
| SMART Reporting | |
| Enable SMART Reporting | <p>Enable or disable Self-Monitoring, Analysis, and Reporting Technology (SMART) during computer startup.</p> <p>By default, the Enable SMART Reporting option is not enabled.</p> |
| Drive Information | |
| SATA-1 | |
| Type | Displays the SATA-1 type information of the computer. |
| Device | Displays the SATA-1 device information of the computer. |
| M.2 PCIe SSD-1 | |
| Type | Displays the M.2 PCIe SSD-1 type information of the computer. |
| Device | Displays the M.2 PCIe SSD-1 device information of the computer. |
| M.2 PCIe SSD-2 | |
| Type | Displays the M.2 PCIe SSD-2 type information of the computer. |
| Device | Displays the M.2 PCIe SSD-2 device information of the computer. |

Table 7. System setup options—Storage menu (continued)

| Storage | |
|---|--|
| Enable MediaCard | |
| Secure Digital (SD) Card | Enable or disable the SD card. By default, the Secure Digital (SD) Card option is enabled. |
| Secure Digital (SD) Card Read-Only Mode | Enable or disable the SD card read-only mode. By default, the Secure Digital (SD) Card Read-Only Mode option is not enabled. |

Table 8. System setup options—Display menu

| Display | |
|-----------------------------|--|
| Display Brightness | |
| Brightness on battery power | Enable to set screen brightness when the computer is running on battery power. |
| Brightness on AC power | Enable to set screen brightness when the computer is running on AC power. |
| Full Screen Logo | Enable or disable full screen logo. By default, the option is not enabled. |

Table 9. System setup options—Connection menu

| Connection | |
|---|--|
| Network Controller Configuration | |
| Integrated NIC | Controls the on-board LAN controller. By default, the Enabled with PXE option is enabled. |
| Enable UEFI Network Stack | Enable or disable UEFI Network Stack. By default, the Enable UEFI Network Stack and Enabled w/PXE option are enabled. |
| Wireless Device Enable | |
| WWAN/GPS | Enable or disable the internal WWAN/GPS device By default, the option enabled. |
| WWAN Bus Mode | Set the interface type of the Wireless Wan (WWAN) card. By default, the Bus Mode PCIe option is enabled. |
| WLAN | Enable or disable the internal WLAN device By default, the option enabled. |
| Bluetooth | Enable or disable the internal Bluetooth device By default, the option enabled. |
| Contactless smartcard/NFC | Enable or disable the internal Contactless smartcard/NFC device By default, the option enabled. |
| Enable UEFI Network Stack | Enable or disable UEFI Network Stack and controls the on-board LAN Controller. By default, the Enable UEFI Network Stack option are enabled. |
| Wireless Radio Control | |
| Control WLAN radio | Sense the connection of the computer to a wired network and subsequently disable the selected wireless radios (WLAN). |

Table 9. System setup options—Connection menu (continued)

| Connection | |
|---------------------------|--|
| Control WWAN radio | <p>By default, the option is disabled.</p> <p>Sense the connection of the computer to a wired network and subsequently disable the selected wireless radios (WWAN).</p> <p>By default, the option is disabled.</p> |
| HTTPs Boot Feature | |
| HTTPs Boot | <p>Enable or disable the HTTPs Boot feature.</p> <p>By default, the HTTPs Boot option is enabled.</p> |
| HTTPs Boot Mode | <p>With Auto Mode, the HTTPs Boot extracts Boot URL from the DHCP. With Manual Mode, the HTTPs Boot reads Boot URL from the user-provided data.</p> <p>By default, the Auto Mode option is enabled.</p> |

Table 10. System setup options—Power menu

| Power | |
|--|---|
| Battery configuration | <p>Enables the computer to run on battery during peak power usage hours. Use the table Custom Charge Start and Custom Charge Stop, to prevent AC power usage between certain times of each day.</p> <p>By default, the Adaptive option is enabled.</p> |
| Advanced Configuration | |
| Enable Advanced Battery Charge Configuration | <p>Enable or disable the advanced battery charge configuration.</p> <p>By default, the Enable Advanced Battery Charge Configuration option is disabled.</p> |
| Peak Shift | <p>Enables the computer to run on battery during peak power usage hours.</p> <p>By default, the Enable Peak Shift option is enabled.</p> |
| Enable Peak Shift | |
| USB PowerShare | |
| Enable USB PowerShare | <p>Enable or disable the USB PowerShare.</p> <p>By default, the Enable USB PowerShare option is disabled</p> |
| Thermal Management | <p>Enables to cool the fan and processor heat management to adjust the computer performance, noise, and temperature.</p> <p>By default, the Optimized option is enabled.</p> |
| USB Wake Support | |
| Wake on Dell USB-C Dock | <p>When enabled, connecting a Dell USB-C Dock will wake the computer from standby.</p> <p>By default, the Wake on Dell USB-C Dock option is enabled.</p> |
| Block Sleep | <p>Enables to block entering sleep (S3) mode in the operating system.</p> <p>By default, the Block Sleep option is disabled.</p> |
| Lid Switch | <p>Enable or disable the lid switch.</p> <p>By default, the Lid Switch option is enabled.</p> |
| Intel Speed Shift Technology | <p>Enable or disable the Intel speed shift technology support.</p> <p>By default, the Intel Speed Shift Technology option is enabled.</p> |
| Long Life Cycle Primary Battery | <p>By default, the Normal Battery option is enabled.</p> |

Table 11. System setup options—Security menu

| Security | |
|--------------------------------------|---|
| TPM 2.0 Security | |
| TPM 2.0 Security On | Enable or disable TPM 2.0 security options. By default, the TPM 2.0 Security On option is enabled. |
| Attestation Enable | Enables to control whether the Trusted Platform Module (TPM) Endorsement Hierarchy is available to the operating system. By default, the Attestation Enable option is enabled. |
| Key Storage Enable | Enables to control whether the Trusted Platform Module (TPM) Storage Hierarchy is available to the operating system. By default, the Key Storage Enable option is enabled. |
| SHA-256 | BIOS and the TPM will use the SHA-256 hash algorithm to extend measurements into the TPM PCRs during BIOS boot. By default, the SHA-256 option is enabled. |
| Clear | Enables to clear the TPM owner information and returns the TPM to the default state. By default, the Clear option is disabled. |
| PPI ByPass for Clear Commands | Controls the TPM Physical Presence Interface (PPI). By default, the PPI ByPass for clear Commands option is disabled. |
| Intel Total Memory Encryption | |
| Total Memory Encryption | Enable or disable you to protect memory from physical attacks including freeze spray, probing DDR to read the cycles, and others. By default, the Total Memory Encryption option is disabled. |
| Chassis intrusion | |
| | Controls the chassis intrusion feature. By default, the On-Silent option is enabled. |
| SMM Security Mitigation | |
| | Enable or disable SMM Security Mitigation. By default, the option is enabled. |
| Data Wipe on Next Boot | |
| Start Data Wipe | Enable or disable the data wipe on next boot. By default, the option is enabled. |
| Absolute | Enable or disable or permanently disable the BIOS module interface of the optional Absolute Persistence Module service from Absolute software. By default, the option is enabled. |
| UEFI Boot Path Security | Controls whether or not the computer will prompt the user to enter the admin password (if set) when booting to a UEFI boot device from the F12 boot menu. By default, the Always Except Internal HDD option is enabled. |

Table 12. System setup options—Passwords menu

| Passwords | |
|-------------------------------|--|
| Admin Password | Set, change, or delete the administrator password. |
| System Password | Set, change, or delete the computer password. |
| NVMe SSD0 | Set, change, or delete the NVMe SSD0 password. |
| Password Configuration | |

Table 12. System setup options—Passwords menu (continued)

| Passwords | |
|------------------------------------|--|
| Upper Case Letter | Reinforces password must have at least one upper case letter. By default, the option is disabled. |
| Lower Case Letter | Reinforces password must have at least one lower case letter. By default, the option is disabled. |
| Digit | Reinforces password must have at least one digit. By default, the option is disabled. |
| Special Character | Reinforces password must have at least one special character. By default, the option is disabled. |
| Minimum Characters | Set the minimum characters allowed for password. |
| Password Bypass | When enabled, this always prompts for computer and internal hard drive passwords when powered on from the off state. By default, the Disabled option is enabled. |
| Password Changes | |
| Enable Non-Admin Password Changes | Enable or disable to change computer and hard drive password without the need for admin password. By default, the option is enabled. |
| Admin Setup Lockout | |
| Enable Admin Setup Lockout | Enables administrators control over how their users can or cannot access BIOS setup. By default, the option is disabled. |
| Master Password Lockout | |
| Enable Master Password Lockout | When enabled, this will disable the master password support. By default, the option is disabled. |
| Allow Non-Admin PSID Revert | |
| Enable Allow Non-Admin PSID Revert | Controls access to the Physical Security ID (PSID) revert of NVMe hard-drives from the Dell Security Manager prompt. By default, the option is disabled. |

Table 13. System setup options—Update, Recovery menu

| Update, Recovery | |
|--------------------------------------|--|
| UEFI Capsule Firmware Updates | Enable or disable BIOS updates through UEFI capsule update packages. By default, the option is enabled. |
| BIOS Recovery from Hard Drive | Enables the user to recover from certain corrupted BIOS conditions from a recovery file on the user primary hard drive or an external USB key. By default, the option is enabled. |
| BIOS Downgrade | |
| Allow BIOS Downgrade | Enable or disable the flashing of the computer firmware to previous revision is blocked. By default, the option is enabled. |
| SupportAssist OS Recovery | Enable or disable the boot flow for SupportAssist OS Recovery tool in the event of certain computer errors. |

Table 13. System setup options—Update, Recovery menu (continued)

| Update, Recovery | |
|---------------------------------|---|
| BISOConnect | <p>By default, the option is enabled.</p> <p>Enable or disable cloud Service OS recovery if the main operating system fails to boot with the number of failures equal to or greater than the value specified by the Auto OS Recovery Threshold setup option and local Service OS does not boot or is not installed.</p> |
| Dell Auto OS Recovery Threshold | <p>By default, the option is enabled.</p> <p>Controls the automatic boot flow for SupportAssist System Resolution Console and for Dell OS Recovery Tool.</p> <p>By default, the threshold value is set to 2.</p> |

Table 14. System setup options—System Management menu

| System Management | |
|--------------------|---|
| Service Tag | Display the Service Tag of the computer. |
| Asset Tag | Create a computer Asset Tag. |
| AC Behavior | |
| Wake on AC | <p>Enable or disable the wake on AC option.</p> <p>By default, the option is disabled.</p> |
| Wake on LAN | |
| Wake on LAN | <p>Enable or disable the computer to power on by special LAN signals when it receives a wakeup signal from the WLAN.</p> <p>By default, the Disabled option is selected.</p> |
| Auto on Time | <p>Enable to set the computer to turn on automatically every day or on a preselected date and time. This option can be configured only if the Auto On Time is set to Everyday, Weekdays, or Selected Days.</p> <p>By default, the option is disabled.</p> |

Table 15. System setup options—Keyboard menu

| Keyboard | |
|--|--|
| Numlock Enable | <p>Enable or disable the Numlock function when the computer boots.</p> <p>By default, the option is enabled.</p> |
| Fn Lock Options | By default, the Fn lock option is enabled. |
| Keyboard Illumination | <p>Enables to change the keyboard illumination settings.</p> <p>By default, the Bright option is enabled.</p> |
| Keyboard Backlight Timeout on AC | <p>Set the timeout value for the keyboard backlight when an AC adapter is connected to the computer.</p> <p>By default, the 10 seconds option is enabled.</p> |
| Keyboard Backlight Timeout on Battery | <p>Set the timeout value for the keyboard backlight when the is running only on battery power.</p> <p>By default, the 10 seconds option is enabled.</p> |
| Device Configuration Hotkey Access | <p>Manages whether you can access device configuration screens through hotkeys during computer startup.</p> <p>By default, the option is enabled.</p> |

Table 16. System setup options—Pre-boot Behavior menu

| Pre-boot Behavior | |
|---------------------------------|---|
| Adapter Warnings | |
| Enable Adapter Warnings | Enable or disable the warning messages during boot when the adapters with less power capacity are detected. By default, the option is enabled. |
| Warning and Errors | |
| | Enable or disable the action to be done when a warning or error is encountered. By default, the Prompt on Warnings and Errors option is enabled. |
| Fastboot | |
| | Enable to set the speed of the boot process. By default, the Minimal option is enabled. |
| Extend BIOS POST Time | |
| | Set the BIOS POST time. By default, the 0 seconds option is enabled. |
| MAC Address Pass-Through | |
| | Replaces the external NIC MAC address with the selected MAC address from the computer. By default, the System Unique MAC Address option is enabled. |

Table 17. System setup options—Virtualization menu

| Virtualization | |
|---|---|
| Intel Virtualization Technology | |
| Enable Intel Virtualization Technology (VT) | Specify whether a Virtual Machine Monitor (VMM) can utilize the additional hardware capabilities provided by Intel Virtualization Technology. By default, the option is enabled. |
| VT for Direct I/O | |
| | Specify whether a Virtual Machine Monitor (VMM) can utilize the additional hardware capabilities provided by Intel Virtualization Technology for Direct I/O. By default, the option is enabled. |
| Intel Trusted Execution Technology (TXT) | |
| Enable Intel Trusted Execution Technology (TXT) | Specifies whether a measured Virtual Machine Monitor (MVMM) can utilize the additional hardware capabilities provided by Intel Trusted Execution Technology. By default, the option is disabled. |

Table 18. System setup options—Performance menu

| Performance | |
|-----------------------------------|--|
| Multi Core Support | |
| Active Cores | Enables to change the number of CPU cores available to the operating system. By default, the All Cores options is enabled. |
| Intel SpeedStep | |
| Enable Intel SpeedStep Technology | Enables the computer to dynamically adjust processor voltage and core frequency, decreasing average power consumption and heat production. By default, the option is enabled. |
| C-States Control | |
| Enable C-State Control | Enable or disable additional processor sleep states. By default, the option is enabled. |

Table 18. System setup options—Performance menu (continued)

| Performance | |
|---|--|
| Intel TurboBoost Technology | |
| Enable Intel Turbo Boost Technology | Enable or disable Intel TurboBoost mode of the processor. By default, the option is enabled. |
| Intel Hyper-Threading Technology | |
| Enable Intel Hyper-Threading Technology | Enable or disable Hyper-Threading in the processor. By default, the option is enabled. |
| Dynamic Tuning:Machine Learning | |
| Enable Dynamic Tuning:Machine Learning | Enables the operating system capability to enhance dynamic power tuning capabilities based on detected workloads. By default, the option is disabled. |

Table 19. System setup options—System Logs menu

| System Logs | |
|----------------------------|---|
| BIOS Event Log | |
| Clear Bios Event Log | Display BIOS events. By default, the Keep option is enabled. |
| Thermal Event Log | |
| Clear Thermal Event Log | Display Thermal events. By default, the Keep option is enabled. |
| Power Event Log | |
| Clear Power Event Log | Display power events. By default, the Keep option is enabled. |
| License Information | Displays the license information of the computer. |

Updating the BIOS

Updating the BIOS in Windows

About this task

CAUTION: If BitLocker is not suspended before updating the BIOS, the next time you reboot the system it will not recognize the BitLocker key. You will then be prompted to enter the recovery key to progress and the system will ask for this on each reboot. If the recovery key is not known this can result in data loss or an unnecessary operating system re-install. For more information on this subject, see Knowledge Article: <https://www.dell.com/support/article/sln153694>

Steps

1. Go to www.dell.com/support.
2. Click **Product support**. In the **Search support** box, enter the Service Tag of your computer, and then click **Search**.
NOTE: If you do not have the Service Tag, use the SupportAssist feature to automatically identify your computer. You can also use the product ID or manually browse for your computer model.
3. Click **Drivers & Downloads**. Expand **Find drivers**.

4. Select the operating system installed on your computer.
5. In the **Category** drop-down list, select **BIOS**.
6. Select the latest version of BIOS, and click **Download** to download the BIOS file for your computer.
7. After the download is complete, browse the folder where you saved the BIOS update file.
8. Double-click the BIOS update file icon and follow the on-screen instructions.

For more information, see knowledge base article [000124211](https://www.dell.com/support/article/000124211) at www.dell.com/support.

Updating the BIOS in Linux and Ubuntu

To update the system BIOS on a computer that is installed with Linux or Ubuntu, see the knowledge base article [000131486](https://www.dell.com/support/article/000131486) at www.dell.com/support.

Updating the BIOS using the USB drive in Windows

About this task

 **CAUTION:** If BitLocker is not suspended before updating the BIOS, the next time you reboot the system it will not recognize the BitLocker key. You will then be prompted to enter the recovery key to progress and the system will ask for this on each reboot. If the recovery key is not known this can result in data loss or an unnecessary operating system re-install. For more information on this subject, see Knowledge Article: <https://www.dell.com/support/article/sln153694>

Steps

1. Follow the procedure from step 1 to step 6 in [Updating the BIOS in Windows](#) to download the latest BIOS setup program file.
2. Create a bootable USB drive. For more information, see the knowledge base article [000145519](https://www.dell.com/support/article/000145519) at www.dell.com/support.
3. Copy the BIOS setup program file to the bootable USB drive.
4. Connect the bootable USB drive to the computer that needs the BIOS update.
5. Restart the computer and press **F12**.
6. Select the USB drive from the **One Time Boot Menu**.
7. Type the BIOS setup program filename and press **Enter**.
The **BIOS Update Utility** appears.
8. Follow the on-screen instructions to complete the BIOS update.

Updating the BIOS from the F12 One-Time boot menu

Update your computer BIOS using the BIOS update.exe file that is copied to a FAT32 USB drive and booting from the F12 One-Time boot menu.

About this task

 **CAUTION:** If BitLocker is not suspended before updating the BIOS, the next time you reboot the system it will not recognize the BitLocker key. You will then be prompted to enter the recovery key to progress and the system will ask for this on each reboot. If the recovery key is not known this can result in data loss or an unnecessary operating system re-install. For more information on this subject, see Knowledge Article: <https://www.dell.com/support/article/sln153694>

BIOS Update

You can run the BIOS update file from Windows using a bootable USB drive or you can also update the BIOS from the F12 One-Time boot menu on the computer.

Most of the Dell computers built after 2012 have this capability, and you can confirm by booting your computer to the F12 One-Time Boot Menu to see if BIOS FLASH UPDATE is listed as a boot option for your computer. If the option is listed, then the BIOS supports this BIOS update option.

 **NOTE:** Only computers with BIOS Flash Update option in the F12 One-Time boot menu can use this function.

Updating from the One-Time boot menu

To update your BIOS from the F12 One-Time boot menu, you need the following:

- USB drive formatted to the FAT32 file system (key does not have to be bootable)
- BIOS executable file that you downloaded from the Dell Support website and copied to the root of the USB drive
- AC power adapter that is connected to the computer
- Functional computer battery to flash the BIOS

Perform the following steps to perform the BIOS update flash process from the F12 menu:

 **CAUTION:** Do not turn off the computer during the BIOS update process. The computer may not boot if you turn off your computer.

Steps

1. From a turn off state, insert the USB drive where you copied the flash into a USB port of the computer.
2. Turn on the computer and press F12 to access the One-Time Boot Menu, select BIOS Update using the mouse or arrow keys then press Enter.
The flash BIOS menu is displayed.
3. Click **Flash from file**.
4. Select external USB device.
5. Select the file and double-click the flash target file, and then click **Submit**.
6. Click **Update BIOS**. The computer restarts to flash the BIOS.
7. The computer will restart after the BIOS update is completed.

System and setup password

Table 20. System and setup password

| Password type | Description |
|-----------------|--|
| System password | Password that you must enter to log on to your system. |
| Setup password | Password that you must enter to access and make changes to the BIOS settings of your computer. |

You can create a system password and a setup password to secure your computer.

 **CAUTION:** The password features provide a basic level of security for the data on your computer.

 **CAUTION:** Anyone can access the data stored on your computer if it is not locked and left unattended.

 **NOTE:** System and setup password feature is disabled.

Assigning a system setup password

Prerequisites

You can assign a new **System or Admin Password** only when the status is in **Not Set**.

About this task

To enter the system setup, press F2 immediately after a power-on or reboot.

Steps

1. In the **System BIOS** or **System Setup** screen, select **Security** and press **Enter**.
The **Security** screen is displayed.
2. Select **System/Admin Password** and create a password in the **Enter the new password** field.

Use the following guidelines to assign the system password:

- A password can have up to 32 characters.
- The password can contain the numbers 0 through 9.
- Only lower case letters are valid, upper case letters are not allowed.
- Only the following special characters are allowed: space, ("), (+), (,), (-), (.), (/), (;), ([), (\), (]), (`).

3. Type the system password that you entered earlier in the **Confirm new password** field and click **OK**.
4. Press **Esc** and a message prompts you to save the changes.
5. Press **Y** to save the changes.
The computer reboots.

Deleting or changing an existing system setup password

Prerequisites

Ensure that the **Password Status** is Unlocked (in the System Setup) before attempting to delete or change the existing System and Setup password. You cannot delete or change an existing System or Setup password, if the **Password Status** is Locked.

About this task

To enter the System Setup, press **F2** immediately after a power-on or reboot.

Steps

1. In the **System BIOS** or **System Setup** screen, select **System Security** and press **Enter**.
The **System Security** screen is displayed.
2. In the **System Security** screen, verify that **Password Status** is **Unlocked**.
3. Select **System Password**, alter or delete the existing system password and press **Enter** or **Tab**.
4. Select **Setup Password**, alter or delete the existing setup password and press **Enter** or **Tab**.

 **NOTE:** If you change the System and/or Setup password, re enter the new password when prompted. If you delete the System and Setup password, confirm the deletion when prompted.

5. Press **Esc** and a message prompts you to save the changes.
6. Press **Y** to save the changes and exit from System Setup.
The computer restarts.

Clearing BIOS (System Setup) and System passwords

About this task

To clear the system or BIOS passwords, contact Dell technical support as described at www.dell.com/contactdell.

 **NOTE:** For information on how to reset Windows or application passwords, refer to the documentation accompanying Windows or your application.

Troubleshooting

Topics:

- [Handling swollen Lithium-ion batteries](#)
- [Dell SupportAssist Pre-boot System Performance Check diagnostics](#)
- [Built-in self-test \(BIST\)](#)
- [System diagnostic lights](#)
- [Recovering the operating system](#)
- [Real-Time Clock \(RTC Reset\)](#)
- [Backup media and recovery options](#)
- [WiFi power cycle](#)
- [Drain residual flea power \(perform hard reset\)](#)

Handling swollen Lithium-ion batteries

Like most laptops, Dell laptops use lithium-ion batteries. One type of lithium-ion battery is the lithium-ion polymer battery. Lithium-ion polymer batteries have increased in popularity in recent years and have become standard in the electronics industry due to customer preferences for a slim form factor (especially with newer ultra-thin laptops) and long battery life. Inherent to lithium-ion polymer battery technology is the potential for swelling of the battery cells.

Swollen battery may impact the performance of the laptop. To prevent possible further damage to the device enclosure or internal components leading to malfunction, discontinue the use of the laptop and discharge it by disconnecting the AC adapter and letting the battery drain.

Swollen batteries should not be used and should be replaced and disposed of properly. We recommend contacting Dell product support for options to replace a swollen battery under the terms of the applicable warranty or service contract, including options for replacement by a Dell authorized service technician.

The guidelines for handling and replacing Lithium-ion batteries are as follows:

- Exercise caution when handling Lithium-ion batteries.
- Discharge the battery before removing it from the system. To discharge the battery, unplug the AC adapter from the system and operate the system only on battery power. When the system will no longer power on when the power button is pressed, the battery is fully discharged.
- Do not crush, drop, mutilate, or penetrate the battery with foreign objects.
- Do not expose the battery to high temperatures, or disassemble battery packs and cells.
- Do not apply pressure to the surface of the battery.
- Do not bend the battery.
- Do not use tools of any type to pry on or against the battery.
- If a battery gets stuck in a device as a result of swelling, do not try to free it as puncturing, bending, or crushing a battery can be dangerous.
- Do not attempt to reassemble a damaged or swollen battery into a laptop.
- Swollen batteries that are covered under warranty should be returned to Dell in an approved shipping container (provided by Dell)—this is to comply with transportation regulations. Swollen batteries that are not covered under warranty should be disposed of at an approved recycling center. Contact Dell product support at <https://www.dell.com/support> for assistance and further instructions.
- Using a non-Dell or incompatible battery may increase the risk of fire or explosion. Replace the battery only with a compatible battery purchased from Dell that is designed to work with your Dell computer. Do not use a battery from other computers with your computer. Always purchase genuine batteries from <https://www.dell.com> or otherwise directly from Dell.

Lithium-ion batteries can swell for various reasons such as age, number of charge cycles, or exposure to high heat. For more information on how to improve the performance and lifespan of the laptop battery and to minimize the possibility of occurrence of the issue, see [Dell Laptop Battery - Frequently Asked Questions](#).

Dell SupportAssist Pre-boot System Performance Check diagnostics

About this task

SupportAssist diagnostics (also known as system diagnostics) performs a complete check of your hardware. The Dell SupportAssist Pre-boot System Performance Check diagnostics is embedded with the BIOS and is launched by the BIOS internally. The embedded system diagnostics provides a set of options for particular devices or device groups allowing you to:

- Run tests automatically or in an interactive mode
- Repeat tests
- Display or save test results
- Run thorough tests to introduce additional test options to provide extra information about the failed device(s)
- View status messages that inform you if tests are completed successfully
- View error messages that inform you of problems encountered during testing

 **NOTE:** Some tests for specific devices require user interaction. Always ensure that you are present at the computer terminal when the diagnostic tests are performed.

For more information, see [Resolve Hardware Issues With Built-in and Online Diagnostics \(SupportAssist ePSA, ePSA or PSA Error Codes\)](#).

Running the SupportAssist Pre-Boot System Performance Check

Steps

1. Turn on your computer.
2. As the computer boots, press the F12 key as the Dell logo appears.
3. On the boot menu screen, select the **Diagnostics** option.
4. Click the arrow at the bottom left corner.
Diagnostics front page is displayed.
5. Click the arrow in the lower-right corner to go to the page listing.
The items detected are listed.
6. To run a diagnostic test on a specific device, press Esc and click **Yes** to stop the diagnostic test.
7. Select the device from the left pane and click **Run Tests**.
8. If there are any issues, error codes are displayed.
Note the error code and validation number and contact Dell.

Built-in self-test (BIST)

M-BIST

M-BIST (Built In Self-Test) is the system board's built-in self-test diagnostics tool that improves the diagnostics accuracy of system board embedded controller (EC) failures.

 **NOTE:** M-BIST can be manually initiated before POST (Power On Self Test).

How to run M-BIST

 **NOTE:** M-BIST must be initiated on the system from a power-off state either connected to AC power or with battery only.

1. Press and hold both the **M** key on the keyboard and the **power button** to initiate M-BIST.
2. With both the **M** key and the **power button** held down, the battery indicator LED may exhibit two states:
 - a. OFF: No fault detected with the system board
 - b. AMBER: Indicates a problem with the system board

- If there is a failure with the system board, the battery status LED will flash one of the following error codes for 30 seconds:

Table 21. LED error codes

| Blinking Pattern | | Possible Problem |
|------------------|-------|---------------------------|
| Amber | White | |
| 2 | 1 | CPU Failure |
| 2 | 8 | LCD Power Rail Failure |
| 1 | 1 | TPM Detection Failure |
| 2 | 4 | Unrecoverable SPI Failure |

- If there is no failure with the system board, the LCD will cycle through the solid color screens described in the LCD-BIST section for 30 seconds and then power off.

LCD Power rail test (L-BIST)

L-BIST is an enhancement to the single LED error code diagnostics and is automatically initiated during POST. L-BIST will check the LCD power rail. If there is no power being supplied to the LCD (i.e., the L-BIST circuit fails), the battery status LED will flash either an error code [2,8] or an error code [2,7].

NOTE: If L-BIST fails, LCD-BIST cannot function as no power will be supplied to the LCD.

How to invoke L-BIST Test:

- Press the power button to start the system.
- If the system does not start up normally, look at the battery status LED:
 - If the battery status LED flashes an error code [2,7], the display cable may not be connected properly.
 - If the battery status LED flashes an error code [2,8], there is a failure on the LCD power rail of the system board, hence there is no power supplied to the LCD.
- For cases, when a [2,7] error code is shown, check to see if the display cable is properly connected.
- For cases when a [2,8] error code is shown, replace the system board.

LCD Built-in Self Test (BIST)

Dell laptops have a built-in diagnostic tool that helps you determine if the screen abnormality you are experiencing is an inherent problem with the LCD (screen) of the Dell laptop or with the video card (GPU) and PC settings.

When you notice screen abnormalities like flickering, distortion, clarity issues, fuzzy or blurry image, horizontal or vertical lines, color fade etc., it is always a good practice to isolate the LCD (screen) by running the Built-In Self Test (BIST).

How to invoke LCD BIST Test

- Power off the Dell laptop.
- Disconnect any peripherals that are connected to the laptop. Connect only the AC adapter (charger) to the laptop.
- Ensure that the LCD (screen) is clean (no dust particles on the surface of the screen).
- Press and hold **D** key and **Power on** the laptop to enter LCD built-in self test (BIST) mode. Continue to hold the D key, until the system boots up.
- The screen will display solid colors and change colors on the entire screen to white, black, red, green, and blue twice.
- Then it will display the colors white, black and red.
- Carefully inspect the screen for abnormalities (any lines, fuzzy color or distortion on the screen).
- At the end of the last solid color (red), the system will shut down.

NOTE: Dell SupportAssist Pre-boot diagnostics upon launch, initiates an LCD BIST first, expecting a user intervention confirm functionality of the LCD.

System diagnostic lights

Battery-status light

Indicates the power and battery-charge status.

Solid white — Power adapter is connected and the battery has more than 5 percent charge.

Amber — Computer is running on battery and the battery has less than 5 percent charge.

Off

- Power adapter is connected and the battery is fully charged.
- Computer is running on battery and the battery has more than 5 percent charge.
- Computer is in sleep state, hibernation, or turned off.

The power and battery-status light blinks amber along with beep codes indicating failures.

For example, the power and battery-status light blinks amber two times followed by a pause, and then blinks white three times followed by a pause. This 2,3 pattern continues until the computer is turned off indicating no memory or RAM is detected.

The following table shows different power and battery-status light patterns and associated problems.

| Blinking Pattern | | Problem description | Suggested resolution |
|------------------|---|--|--|
| 1 | 1 | TPM detection failure | Replace the system board. |
| 1 | 2 | Unrecoverable SPI flash failure | Replace the system board. |
| 1 | 5 | EC unable to program i-Fuse | Replace the system board. |
| 1 | 6 | Generic catch-all for ungraceful EC code flow errors | Disconnect all power source (AC, battery, coin cell) and drain flea power by pressing & holding down power button. |
| 2 | 1 | CPU failure | Run the Intel CPU diagnostics tools. If problem persists, replace the system board. |
| 2 | 2 | System Board failure (included BIOS corruption or ROM error) | Flash latest BIOS version. If problem persists, replace the system board. |
| 2 | 3 | No Memory / RAM detected | Confirm that the memory module is installed properly. If problem persists, replace the memory module. |
| 2 | 4 | Memory / RAM failure | Reset and swap memory modules amongst the slots. If problem persists, replace the memory module. |
| 2 | 5 | Invalid memory installed | Reset and swap memory modules amongst the slots. If problem persists, replace the memory module. |
| 2 | 6 | System board / Chipset Error | Replace the system board. |
| 2 | 7 | LCD failure (SBIOS message) | Replace the LCD module. |
| 2 | 8 | LCD failure (EC detection of power rail failure) | Replace the system board. |
| 3 | 1 | CMOS battery failure | Reset the CMOS battery connection. If problem persists, replace the RTC battery. |

| Blinking Pattern | | Problem description | Suggested resolution |
|------------------|---|---|---|
| 3 | 2 | PCI or Video card/chip failure | Replace the system board. |
| 3 | 3 | BIOS recovery image not found | Flash latest BIOS version. If problem persists, replace the system board. |
| 3 | 4 | BIOS recovery image found but invalid | Flash latest BIOS version. If problem persists, replace the system board. |
| 3 | 5 | Power rail failure | Replace the system board. |
| 3 | 6 | Flash corruption detected by SBIOS. | Replace the system board. |
| 3 | 7 | Timeout waiting on ME to reply to HECI message. | Replace the system board. |

Camera status light: Indicates whether the camera is in use.

- Solid white — Camera is in use.
- Off — Camera is not in use.

Caps Lock status light: Indicates whether Caps Lock is enabled or disabled.

- Solid white — Caps Lock enabled.
- Off — Caps Lock disabled.

Recovering the operating system

When your computer is unable to boot to the operating system even after repeated attempts, it automatically starts Dell SupportAssist OS Recovery.

Dell SupportAssist OS Recovery is a standalone tool that is preinstalled in all Dell computers installed with Windows 10 operating system. It consists of tools to diagnose and troubleshoot issues that may occur before your computer boots to the operating system. It enables you to diagnose hardware issues, repair your computer, back up your files, or restore your computer to its factory state.

You can also download it from the Dell Support website to troubleshoot and fix your computer when it fails to boot into their primary operating system due to software or hardware failures.

For more information about the Dell SupportAssist OS Recovery, see *Dell SupportAssist OS Recovery User's Guide* at www.dell.com/support.

Real-Time Clock (RTC Reset)

The Real Time Clock (RTC) reset function allows you to recover Dell computer from No POST, No Power or, No Boot like situations. There is no coin-cell battery on this computer, the main battery reserves 2% of its capacity for RTC function.

How to Reset the Real-Time Clock (RTC)

- Start the RTC reset with the computer powered off and connected to AC power.
- Press and hold the power button for thirty (30-35) seconds.
- The computer RTC Reset occurs after you release the power button.

 **NOTE:** For more information, see the knowledge base article 000125880 at <https://www.dell.com/support/>.

Backup media and recovery options

It is recommended to create a recovery drive to troubleshoot and fix problems that may occur with Windows. Dell proposes multiple options for recovering Windows operating system on your Dell PC. For more information, see [Dell Windows Backup Media and Recovery Options](#).

WiFi power cycle

About this task

If your computer is unable to access the internet due to WiFi connectivity issues a WiFi power cycle procedure may be performed. The following procedure provides the instructions on how to conduct a WiFi power cycle:

 **NOTE:** Some ISPs (Internet Service Providers) provide a modem/router combo device.

Steps

1. Turn off your computer.
2. Turn off the modem.
3. Turn off the wireless router.
4. Wait for 30 seconds.
5. Turn on the wireless router.
6. Turn on the modem.
7. Turn on your computer.

Drain residual flea power (perform hard reset)

About this task

Flea power is the residual static electricity that remains in the computer even after it has been powered off and the battery is removed.

For your safety, and to protect the sensitive electronic components in your computer, you are requested to drain residual flea power before removing or replacing any components in your computer.

Draining residual flea power, also known as a performing a "hard reset", is also a common troubleshooting step if your computer does not power on or boot into the operating system.

To drain residual flea power (perform a hard reset)

Steps

1. Turn off your computer.
2. Disconnect the power adapter from your computer.
3. Remove the base cover.
4. Remove the battery.
5. Press and hold the power button for 20 seconds to drain the flea power.
6. Install the battery.
7. Install the base cover.
8. Connect the power adapter to your computer.
9. Turn on your computer.

 **NOTE:** For more information about performing a hard reset, see the knowledge base article [SLN85632](https://www.dell.com/support) at www.dell.com/support.

Getting help and contacting Dell

Self-help resources

You can get information and help on Dell products and services using these self-help resources:

Table 22. Self-help resources

| Self-help resources | Resource location |
|--|---|
| Information about Dell products and services | www.dell.com |
| Tips |  |
| Contact Support | In Windows search, type <code>Contact Support</code> , and press Enter. |
| Online help for operating system | www.dell.com/support/windows www.dell.com/support/linux |
| Troubleshooting information, user manuals, setup instructions, product specifications, technical help blogs, drivers, software updates, and so on. | www.dell.com/support |
| Dell knowledge base articles for a variety of computer concerns. | <ol style="list-style-type: none"> 1. Go to https://www.dell.com/support/home/?app=knowledgebase. 2. Type the subject or keyword in the Search box. 3. Click Search to retrieve the related articles. |

Contacting Dell

To contact Dell for sales, technical support, or customer service issues, see www.dell.com/contactdell.

 **NOTE:** Availability varies by country and product, and some services may not be available in your country.

 **NOTE:** If you do not have an active internet connection, you can find contact information on your purchase invoice, packing slip, bill, or Dell product catalog.