

Vostro 3681

Service Manual



Notes, cautions, and warnings

 **NOTE:** A NOTE indicates important information that helps you make better use of your product.

 **CAUTION:** A CAUTION indicates either potential damage to hardware or loss of data and tells you how to avoid the problem.

 **WARNING:** A WARNING indicates a potential for property damage, personal injury, or death.

Chapter 1: Working on your computer	6
Safety instructions.....	6
Before working inside your computer.....	6
Safety precautions.....	7
Electrostatic discharge—ESD protection.....	7
ESD field service kit	8
Transporting sensitive components.....	9
After working inside your computer.....	9
Chapter 2: Technology and components	10
DDR4.....	10
USB features.....	11
HDMI 1.4b.....	13
Chapter 3: Disassembly and reassembly	14
Recommended tools.....	14
Screw size list.....	14
System board layout.....	15
Side cover.....	16
Removing the side cover.....	16
Installing the side cover.....	18
Bezel.....	19
Removing the front bezel.....	19
Installing the front bezel.....	20
3.5 in. Hard disk drive.....	21
Removing the 3.5-inch hard drive.....	21
Installing the 3.5-inch hard drive	21
HDD/ODD Bracket.....	22
Removing the HDD/ODD bracket.....	22
Installing the HDD/ODD bracket.....	24
Optical drive.....	27
Removing the Optical Disk Drive.....	27
Installing the Optical Disk Drive.....	28
Memory module.....	29
Removing the memory modules.....	29
Installing the memory modules.....	30
Graphics card.....	31
Removing the graphics card.....	31
Installing the graphics card.....	32
Coin cell battery.....	33
Removing the coin-cell battery.....	33
Installing the coin-cell battery.....	33
M.2 2230 Solid state drive.....	34
Removing the 2230 solid-state drive.....	34

Installing the 2230 solid-state drive.....	35
M.2 2280 Solid state drive.....	36
Removing the 2280 solid-state drive.....	36
Installing the 2280 solid-state drive.....	37
WLAN Card.....	38
Removing the WLAN card.....	38
Installing the WLAN card.....	39
SD card.....	41
Removing the media card reader.....	41
Installing the media card reader.....	41
Power supply unit.....	42
Removing the power-supply unit.....	42
Installing the power-supply unit.....	44
Heatsink assembly.....	47
Removing the heatsink assembly.....	47
Installing the heatsink assembly.....	48
Processor.....	49
Removing the processor.....	49
Installing the processor.....	51
System board.....	52
Removing the system board.....	52
Installing the system board.....	55
Chapter 4: System setup.....	59
BIOS overview.....	59
Entering BIOS setup program.....	59
Boot menu.....	59
Navigation keys.....	59
Boot Sequence.....	60
System setup options.....	60
Updating the BIOS.....	65
Updating the BIOS in Windows.....	65
Updating the BIOS in Linux and Ubuntu.....	65
Updating the BIOS using the USB drive in Windows.....	65
Updating the BIOS from the F12 One-Time boot menu.....	66
System and setup password.....	66
Assigning a system setup password.....	67
Deleting or changing an existing system setup password.....	67
Clearing CMOS settings/RTC reset.....	68
Clearing BIOS (System Setup) and System passwords.....	68
Chapter 5: Troubleshooting.....	69
Dell SupportAssist Pre-boot System Performance Check diagnostics.....	69
Running the SupportAssist Pre-Boot System Performance Check.....	69
Real-Time Clock (RTC Reset).....	69
System diagnostic lights.....	70
Diagnostic error messages.....	71
System error messages.....	73
Recovering the operating system.....	74

Updating the BIOS using the USB drive in Windows.....74
Updating the BIOS in Windows.....75
Backup media and recovery options.....75
WiFi power cycle.....75
Drain residual flea power (perform hard reset).....75

Chapter 6: Getting help and contacting Dell..... 77

Working on your computer

Safety instructions

Prerequisites

Use the following safety guidelines to protect your computer from potential damage and to ensure your personal safety. Unless otherwise noted, each procedure included in this document assumes that the following conditions exist:

- You have read the safety information that shipped with your computer.
- A component can be replaced or, if purchased separately, installed by performing the removal procedure in reverse order.

About this task

 **WARNING:** Before working inside your computer, read the safety information that shipped with your computer. For additional safety best practices information, see the [Regulatory Compliance Homepage](#)

 **CAUTION:** Many repairs may only be done by a certified service technician. You should only perform troubleshooting and simple repairs as authorized in your product documentation, or as directed by the online or telephone service and support team. Damage due to servicing that is not authorized by Dell is not covered by your warranty. Read and follow the safety instructions that came with the product.

 **CAUTION:** To avoid electrostatic discharge, ground yourself by using a wrist grounding strap or by periodically touching an unpainted metal surface at the same time as touching a connector on the back of the computer.

 **CAUTION:** Handle components and cards with care. Do not touch the components or contacts on a card. Hold a card by its edges or by its metal mounting bracket. Hold a component such as a processor by its edges, not by its pins.

 **CAUTION:** When you disconnect a cable, pull on its connector or on its pull-tab, not on the cable itself. Some cables have connectors with locking tabs; if you are disconnecting this type of cable, press in on the locking tabs before you disconnect the cable. As you pull connectors apart, keep them evenly aligned to avoid bending any connector pins. Also, before you connect a cable, ensure that both connectors are correctly oriented and aligned.

 **NOTE:** Disconnect all power sources before opening the computer cover or panels. After you finish working inside the computer, replace all covers, panels, and screws before connecting to the power source.

 **CAUTION:** Exercise caution when handling Lithium-ion batteries in laptops. Swollen batteries should not be used and should be replaced and disposed properly.

 **NOTE:** The color of your computer and certain components may appear differently than shown in this document.

Before working inside your computer

About this task

To avoid damaging your computer, perform the following steps before you begin working inside the computer.

Steps

1. Ensure that you follow the [Safety Instruction](#).
2. Ensure that your work surface is flat and clean to prevent the computer cover from being scratched.

3. Turn off your computer.
4. Disconnect all network cables from the computer.

 **CAUTION:** To disconnect a network cable, first unplug the cable from your computer and then unplug the cable from the network device.

5. Disconnect your computer and all attached devices from their electrical outlets.
6. Press and hold the power button while the computer is unplugged to ground the system board.

 **NOTE:** To avoid electrostatic discharge, ground yourself by using a wrist grounding strap or by periodically touching an unpainted metal surface at the same time as touching a connector on the back of the computer.

Safety precautions

The safety precautions chapter details the primary steps to be taken before performing any disassembly instructions.

Observe the following safety precautions before you perform any installation or break/fix procedures involving disassembly or reassembly:

- Turn off the system and all attached peripherals.
- Disconnect the system and all attached peripherals from AC power.
- Disconnect all network cables, telephone, and telecommunications lines from the system.
- Use an ESD field service kit when working inside any to avoid electrostatic discharge (ESD) damage.
- After removing any system component, carefully place the removed component on an anti-static mat.
- Wear shoes with non-conductive rubber soles to reduce the chance of getting electrocuted.

Standby power

Dell products with standby power must be unplugged before you open the case. Systems that incorporate standby power are essentially powered while turned off. The internal power enables the system to be remotely turned on (wake on LAN) and suspended into a sleep mode and has other advanced power management features.

Unplugging, pressing and holding the power button for 15 seconds should discharge residual power in the system board.

Bonding

Bonding is a method for connecting two or more grounding conductors to the same electrical potential. This is done through the use of a field service electrostatic discharge (ESD) kit. When connecting a bonding wire, ensure that it is connected to bare metal and never to a painted or non-metal surface. The wrist strap should be secure and in full contact with your skin, and ensure that you remove all jewelry such as watches, bracelets, or rings prior to bonding yourself and the equipment.

Electrostatic discharge—ESD protection

ESD is a major concern when you handle electronic components, especially sensitive components such as expansion cards, processors, memory DIMMs, and system boards. Very slight charges can damage circuits in ways that may not be obvious, such as intermittent problems or a shortened product life span. As the industry pushes for lower power requirements and increased density, ESD protection is an increasing concern.

Due to the increased density of semiconductors used in recent Dell products, the sensitivity to static damage is now higher than in previous Dell products. For this reason, some previously approved methods of handling parts are no longer applicable.

Two recognized types of ESD damage are catastrophic and intermittent failures.

- **Catastrophic** – Catastrophic failures represent approximately 20 percent of ESD-related failures. The damage causes an immediate and complete loss of device functionality. An example of catastrophic failure is a memory DIMM that has received a static shock and immediately generates a "No POST/No Video" symptom with a beep code emitted for missing or nonfunctional memory.
- **Intermittent** – Intermittent failures represent approximately 80 percent of ESD-related failures. The high rate of intermittent failures means that most of the time when damage occurs, it is not immediately recognizable. The DIMM receives a static shock, but the tracing is merely weakened and does not immediately produce outward symptoms related to the damage. The weakened trace may take weeks or months to melt, and in the meantime may cause degradation of memory integrity, intermittent memory errors, etc.

The more difficult type of damage to recognize and troubleshoot is the intermittent (also called latent or "walking wounded") failure.

Perform the following steps to prevent ESD damage:

- Use a wired ESD wrist strap that is properly grounded. The use of wireless anti-static straps is no longer allowed; they do not provide adequate protection. Touching the chassis before handling parts does not ensure adequate ESD protection on parts with increased sensitivity to ESD damage.
- Handle all static-sensitive components in a static-safe area. If possible, use anti-static floor pads and workbench pads.
- When unpacking a static-sensitive component from its shipping carton, do not remove the component from the anti-static packing material until you are ready to install the component. Before unwrapping the anti-static packaging, ensure that you discharge static electricity from your body.
- Before transporting a static-sensitive component, place it in an anti-static container or packaging.

ESD field service kit

The unmonitored Field Service kit is the most commonly used service kit. Each Field Service kit includes three main components: anti-static mat, wrist strap, and bonding wire.

Components of an ESD field service kit

The components of an ESD field service kit are:

- **Anti-Static Mat** – The anti-static mat is dissipative and parts can be placed on it during service procedures. When using an anti-static mat, your wrist strap should be snug and the bonding wire should be connected to the mat and to any bare metal on the system being worked on. Once deployed properly, service parts can be removed from the ESD bag and placed directly on the mat. ESD-sensitive items are safe in your hand, on the ESD mat, in the system, or inside a bag.
- **Wrist Strap and Bonding Wire** – The wrist strap and bonding wire can be either directly connected between your wrist and bare metal on the hardware if the ESD mat is not required, or connected to the anti-static mat to protect hardware that is temporarily placed on the mat. The physical connection of the wrist strap and bonding wire between your skin, the ESD mat, and the hardware is known as bonding. Use only Field Service kits with a wrist strap, mat, and bonding wire. Never use wireless wrist straps. Always be aware that the internal wires of a wrist strap are prone to damage from normal wear and tear, and must be checked regularly with a wrist strap tester in order to avoid accidental ESD hardware damage. It is recommended to test the wrist strap and bonding wire at least once per week.
- **ESD Wrist Strap Tester** – The wires inside of an ESD strap are prone to damage over time. When using an unmonitored kit, it is a best practice to regularly test the strap prior to each service call, and at a minimum, test once per week. A wrist strap tester is the best method for doing this test. If you do not have your own wrist strap tester, check with your regional office to find out if they have one. To perform the test, plug the wrist-strap's bonding-wire into the tester while it is strapped to your wrist and push the button to test. A green LED is lit if the test is successful; a red LED is lit and an alarm sounds if the test fails.
- **Insulator Elements** – It is critical to keep ESD sensitive devices, such as plastic heat sink casings, away from internal parts that are insulators and often highly charged.
- **Working Environment** – Before deploying the ESD Field Service kit, assess the situation at the customer location. For example, deploying the kit for a server environment is different than for a desktop or portable environment. Servers are typically installed in a rack within a data center; desktops or portables are typically placed on office desks or cubicles. Always look for a large open flat work area that is free of clutter and large enough to deploy the ESD kit with additional space to accommodate the type of system that is being repaired. The workspace should also be free of insulators that can cause an ESD event. On the work area, insulators such as Styrofoam and other plastics should always be moved at least 12 inches or 30 centimeters away from sensitive parts before physically handling any hardware components.
- **ESD Packaging** – All ESD-sensitive devices must be shipped and received in static-safe packaging. Metal, static-shielded bags are preferred. However, you should always return the damaged part using the same ESD bag and packaging that the new part arrived in. The ESD bag should be folded over and taped shut and all the same foam packing material should be used in the original box that the new part arrived in. ESD-sensitive devices should be removed from packaging only at an ESD-protected work surface, and parts should never be placed on top of the ESD bag because only the inside of the bag is shielded. Always place parts in your hand, on the ESD mat, in the system, or inside an anti-static bag.
- **Transporting Sensitive Components** – When transporting ESD sensitive components such as replacement parts or parts to be returned to Dell, it is critical to place these parts in anti-static bags for safe transport.

ESD protection summary

It is recommended that all field service technicians use the traditional wired ESD grounding wrist strap and protective anti-static mat at all times when servicing Dell products. In addition, it is critical that technicians keep sensitive parts separate from all insulator parts while performing service and that they use anti-static bags for transporting sensitive components.

Transporting sensitive components

When transporting ESD sensitive components such as replacement parts or parts to be returned to Dell, it is critical to place these parts in anti-static bags for safe transport.

Lifting equipment

Adhere to the following guidelines when lifting heavy weight equipment:

 **CAUTION: Do not lift greater than 50 pounds. Always obtain additional resources or use a mechanical lifting device.**

1. Get a firm balanced footing. Keep your feet apart for a stable base, and point your toes out.
2. Tighten stomach muscles. Abdominal muscles support your spine when you lift, offsetting the force of the load.
3. Lift with your legs, not your back.
4. Keep the load close. The closer it is to your spine, the less force it exerts on your back.
5. Keep your back upright, whether lifting or setting down the load. Do not add the weight of your body to the load. Avoid twisting your body and back.
6. Follow the same techniques in reverse to set the load down.

After working inside your computer

About this task

After you complete any replacement procedure, ensure that you connect any external devices, cards, and cables before turning on your computer.

Steps

1. Connect any telephone or network cables to your computer.

 **CAUTION: To connect a network cable, first plug the cable into the network device and then plug it into the computer.**

2. Connect your computer and all attached devices to their electrical outlets.
3. Turn on your computer.
4. If required, verify that the computer works correctly by running **ePSA diagnostics**.

Technology and components

This chapter details the technology and components available in the system.

DDR4

DDR4 (double data rate fourth generation) memory is a higher-speed successor to the DDR2 and DDR3 technologies and allows up to 512 GB in capacity, compared to the DDR3's maximum of 128 GB per DIMM. DDR4 synchronous dynamic random-access memory is keyed differently from both SDRAM and DDR to prevent the user from installing the wrong type of memory into the system.

DDR4 needs 20 percent less or just 1.2 volts, compared to DDR3 which requires 1.5 volts of electrical power to operate. DDR4 also supports a new, deep power-down mode that allows the host device to go into standby without needing to refresh its memory. Deep power-down mode is expected to reduce standby power consumption by 40 to 50 percent.

DDR4 Details

There are subtle differences between DDR3 and DDR4 memory modules, as listed below.

Key notch difference

The key notch on a DDR4 module is in a different location from the key notch on a DDR3 module. Both notches are on the insertion edge but the notch location on the DDR4 is slightly different, to prevent the module from being installed into an incompatible board or platform.

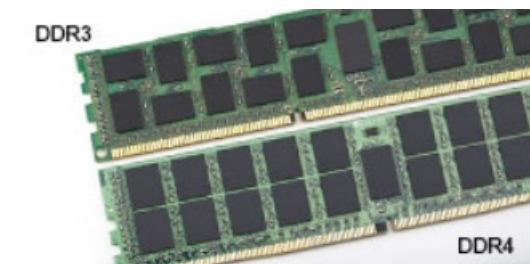

Figure 1. Notch difference

Increased thickness

DDR4 modules are slightly thicker than DDR3, to accommodate more signal layers.



Figure 2. Thickness difference

Curved edge

DDR4 modules feature a curved edge to help with insertion and alleviate stress on the PCB during memory installation.

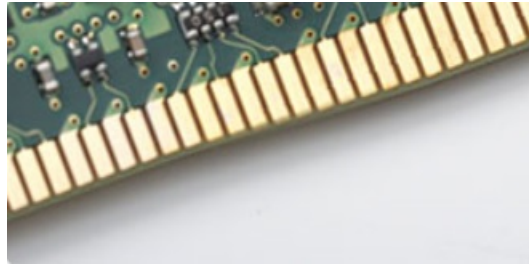

Figure 3. Curved edge

Memory Errors

Memory errors on the system display 2,3 failure code. If all memory fails, the LCD does not turn on. Troubleshoot for possible memory failure by trying known good memory modules in the memory connectors on the bottom of the system or under the keyboard, as in some portable systems.

NOTE: The DDR4 memory is imbedded in board and not a replaceable DIMM as shown and referred.

USB features

Universal Serial Bus, or USB, was introduced in 1996. It dramatically simplified the connection between host computers and peripheral devices like mice, keyboards, external drivers, and printers.

Table 1. USB evolution

Type	Data Transfer Rate	Category	Introduction Year
USB 2.0	480 Mbps	High Speed	2000
USB 3.2 Gen 1	5 Gbps	SuperSpeed	2010

USB 3.2 Gen 1 (SuperSpeed USB)

For years, the USB 2.0 has been firmly entrenched as the de facto interface standard in the PC world with about 6 billion devices sold, and yet the need for more speed grows by ever faster computing hardware and ever greater bandwidth demands. The USB 3.1 Gen 2 finally has the answer to the consumers' demands with a theoretically 10 times faster than its predecessor. In a nutshell, USB 3.2 Gen 1 features are as follows:

- Higher transfer rates (up to 5 Gbps)
- Increased maximum bus power and increased device current draw to better accommodate power-hungry devices
- New power management features
- Full-duplex data transfers and support for new transfer types
- Backward USB 2.0 compatibility
- New connectors and cable

The topics below cover some of the most commonly asked questions regarding USB 3.2 Gen 1.



Speed

Currently, there are 3 speed modes defined by the latest USB 3.2 Gen 1/USB 3.2 Gen 1 and USB 3.2 Gen 2x2 specification. They are Super-Speed, Hi-Speed and Full-Speed. The new SuperSpeed mode has a transfer rate of 4.8 Gbps. While the specification retains Hi-Speed, and Full-Speed USB mode, commonly known as USB 2.0 and 1.1 respectively, the slower modes still operate at 480 Mbps and 12 Mbps respectively and are kept to maintain backward compatibility.

USB 3.2 Gen 1 achieves the much higher performance by the technical changes below:

- An additional physical bus that is added in parallel with the existing USB 2.0 bus (refer to the picture below).
- USB 2.0 previously had four wires (power, ground, and a pair for differential data); USB 3.0/USB 3.1 Gen 1 adds four more for two pairs of differential signals (receive and transmit) for a combined total of eight connections in the connectors and cabling.
- USB 3.2 Gen 1 utilizes the bidirectional data interface, rather than USB 2.0's half-duplex arrangement. This gives a 10-fold increase in theoretical bandwidth.

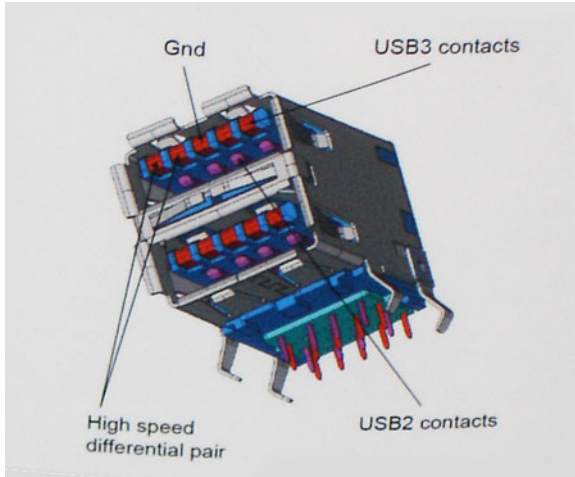

With today's ever increasing demands placed on data transfers with high-definition video content, terabyte storage devices, high megapixel count digital cameras etc., USB 2.0 may not be fast enough. Furthermore, no USB 2.0 connection could ever come close to the 480Mbps theoretical maximum throughput, making data transfer at around 320 Mbps (40 MB/s) — the actual real-world maximum. Similarly, USB 3.0/USB 3.1 Gen 1 connections will never achieve 4.8Gbps. We will likely see a real-world maximum rate of 400MB/s with overheads. At this speed, USB 3.0/USB 3.1 Gen 1 is a 10x improvement over USB 2.0.

Applications

USB 3.2 Gen 1 opens up the laneways and provides more headroom for devices to deliver a better overall experience. Where USB video was barely tolerable previously (both from a maximum resolution, latency, and video compression perspective), it's easy to imagine that with 5-10 times the bandwidth available, USB video solutions should work that much better. Single-link DVI requires almost 2 Gbps throughput. Where 480Mbps was limiting, 5Gbps is more than promising. With its promised 4.8Gbps speed, the standard will find its way into some products that previously weren't USB territory, like external RAID storage systems.

Listed below are some of the available SuperSpeed USB 3.2 Gen 1 products:

- External Desktop USB Hard Drives
- Portable USB Hard Drives
- USB Drive Docks & Adapters
- USB Flash Drives & Readers
- USB Solid-state Drives
- USB RAIDs
- Optical Media Drives
- Multimedia Devices
- Networking
- USB Adapter Cards & Hubs

Compatibility

The good news is that USB 3.2 Gen 1 has been carefully planned from the start to peacefully co-exist with USB 2.0. First of all, while USB 3.2 Gen 1 specifies new physical connections and thus new cables to take advantage of the higher speed capability of the new protocol, the connector itself remains the same rectangular shape with the four USB 2.0 contacts in the exact same location as before. Five new connections to carry receive and transmitted data independently are present on USB 3.2 Gen 1 cables and only come into contact when connected to a proper SuperSpeed USB connection.

HDMI 1.4b

This topic explains the HDMI 1.4b and its features along with the advantages.

HDMI (High-Definition Multimedia Interface) is an industry-supported, uncompressed, all-digital audio/video interface. HDMI provides an interface between any compatible digital audio/video source, such as a DVD player, or A/V receiver and a compatible digital audio and/or video monitor, such as a digital TV (DTV). The intended applications for HDMI TVs, and DVD players. The primary advantage is cable reduction and content protection provisions. HDMI supports standard, enhanced, or high-definition video, plus multichannel digital audio on a single cable.

HDMI 1.4b Features

- **HDMI Ethernet Channel** - Adds high-speed networking to an HDMI link, allowing users to take full advantage of their IP-enabled devices without a separate Ethernet cable
- **Audio Return Channel** - Allows an HDMI-connected TV with a built-in tuner to send audio data "upstream" to a surround audio system, eliminating the need for a separate audio cable
- **3D** - Defines input/output protocols for major 3D video formats, paving the way for true 3D gaming and 3D home theater applications
- **Content Type** - Real-time signaling of content types between display and source devices, enabling a TV to optimize picture settings based on content type
- **Additional Color Spaces** - Adds support for additional color models used in digital photography and computer graphics
- **4K Support** - Enables video resolutions far beyond 1080p, supporting next-generation displays that will rival the Digital Cinema systems used in many commercial movie theaters
- **HDMI Micro Connector** - A new, smaller connector for phones and other portable devices, supporting video resolutions up to 1080p
- **Automotive Connection System** - New cables and connectors for automotive video systems, designed to meet the unique demands of the motoring environment while delivering true HD quality

Advantages of HDMI

- Quality HDMI transfers uncompressed digital audio and video for the highest, crispest image quality.
- Low -cost HDMI provides the quality and functionality of a digital interface while also supporting uncompressed video formats in a simple, cost-effective manner
- Audio HDMI supports multiple audio formats from standard stereo to multichannel surround sound
- HDMI combines video and multichannel audio into a single cable, eliminating the cost, complexity, and confusion of multiple cables currently used in A/V systems
- HDMI supports communication between the video source (such as a DVD player) and the DTV, enabling new functionality

Disassembly and reassembly



Recommended tools

The procedures in this document require the following tools:

- Small flat blade screwdriver
- Phillips # 1 screwdriver
- Small plastic scribe

Screw size list

Table 2. Screw size list

Component	M2x3 	M2X4 	6-32X1/4" 
Hard drive			1
HDD/ODD bracket			1
Optical drive	1		
WLAN	1		
SSD card	1		
Power supply unit (PSU)			3
IO module			6
Internal antenna			
Card reader			2
System board		1	8
Front IO bracket			1

System board layout

This section illustrates the system board and calls out the ports and connectors.

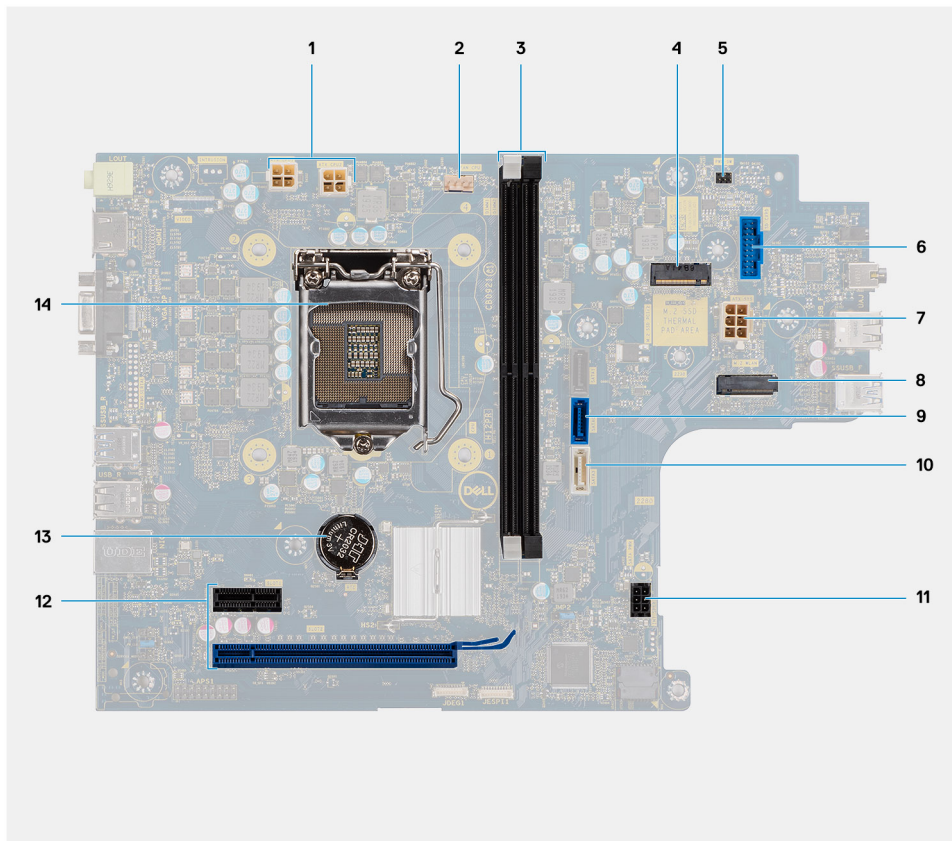

Figure 4. System boards shipped with C-Media audio controller

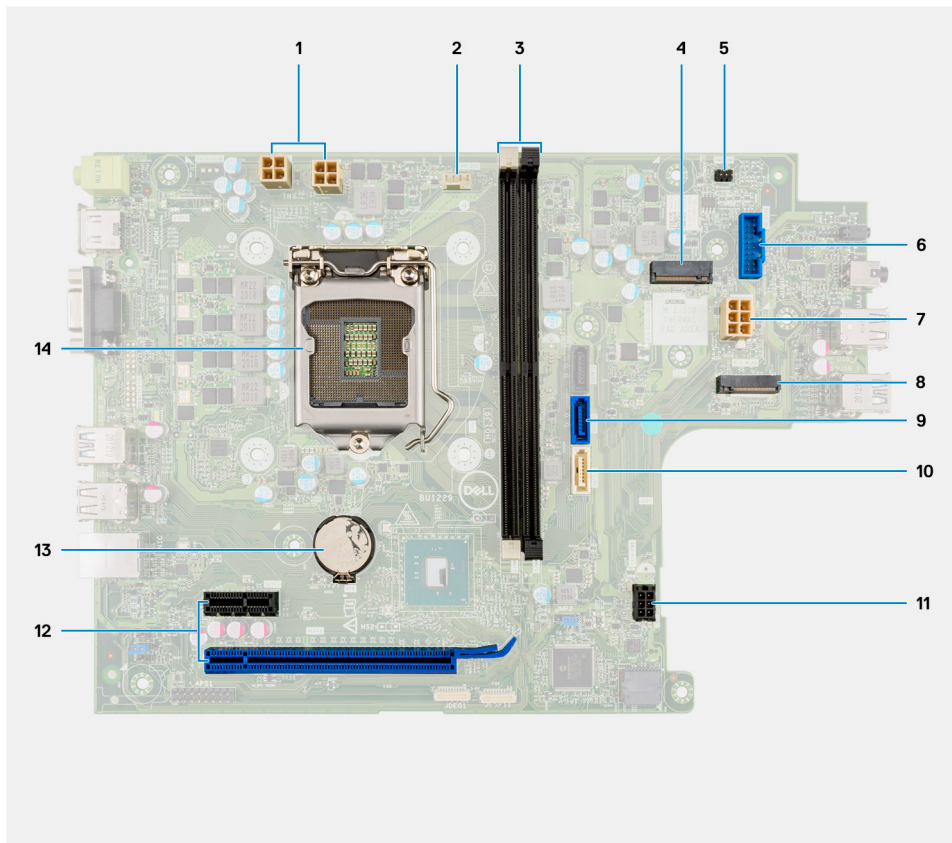

Figure 5. System boards shipped with Realtek audio controller

1. ATX Power connector (ATX_CPU1 and ATX_CPU2)
2. CPU fan connector (Fan_CPU)
3. Memory-module slots (DIMM1, DIMM2)
4. M.2 2230/2280 connector (for SSD)
5. Power switch connector (PWR_SW)
6. SD card reader connector
7. ATX Power connector(ATX_SYS)
8. M.2 2230 connector (for WLAN card)
9. SATA 3.0 data connector (SATA0)
10. SATA 3.0 data connector (SATA3)
11. SATA 3.0 power connector (SATA_PWR)
12. PCIe expansion slots (SLOT1: PCIe x1, SLOT2: PCIe x16)
13. Coin-cell battery
14. CPU socket

Side cover

Removing the side cover

Prerequisites

1. Follow the procedure in [Before working inside your computer.](#)

About this task

The following images indicate the location of the side cover and provide a visual representation of the removal procedure:

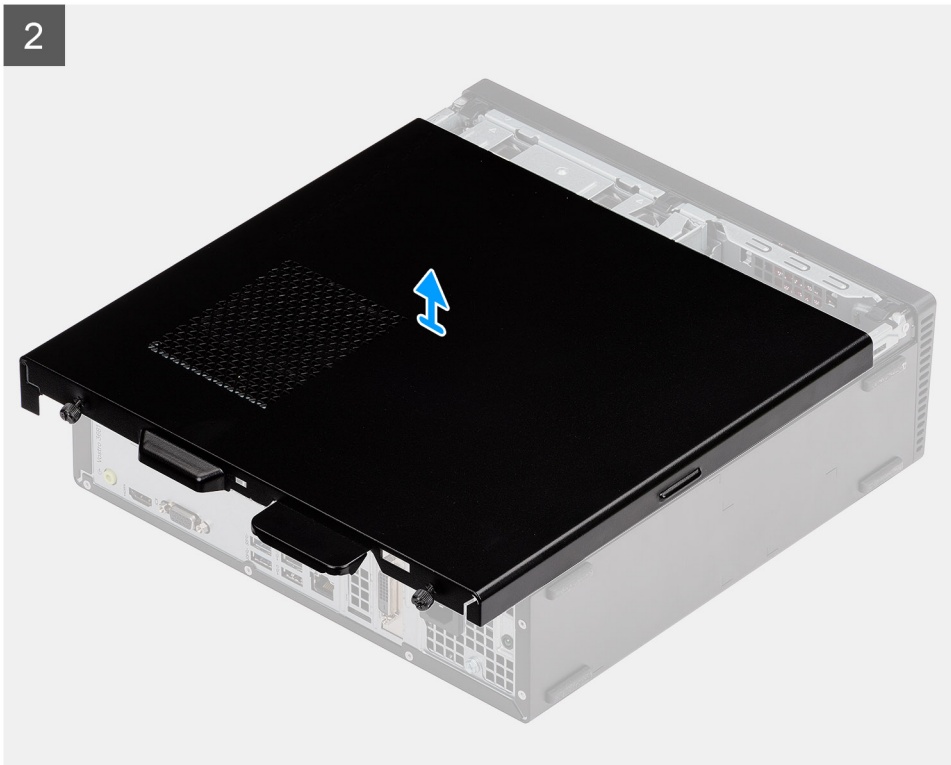

Steps

1. Loosen the two captive screws and slide the side cover to release it from the chassis.
2. Lift the side cover, off the chassis.

Installing the side cover

Prerequisites

If you are replacing a component, remove the existing component before performing the installation procedure:

About this task

The following images indicate the location of the side cover and provide a visual representation of the installation procedure:

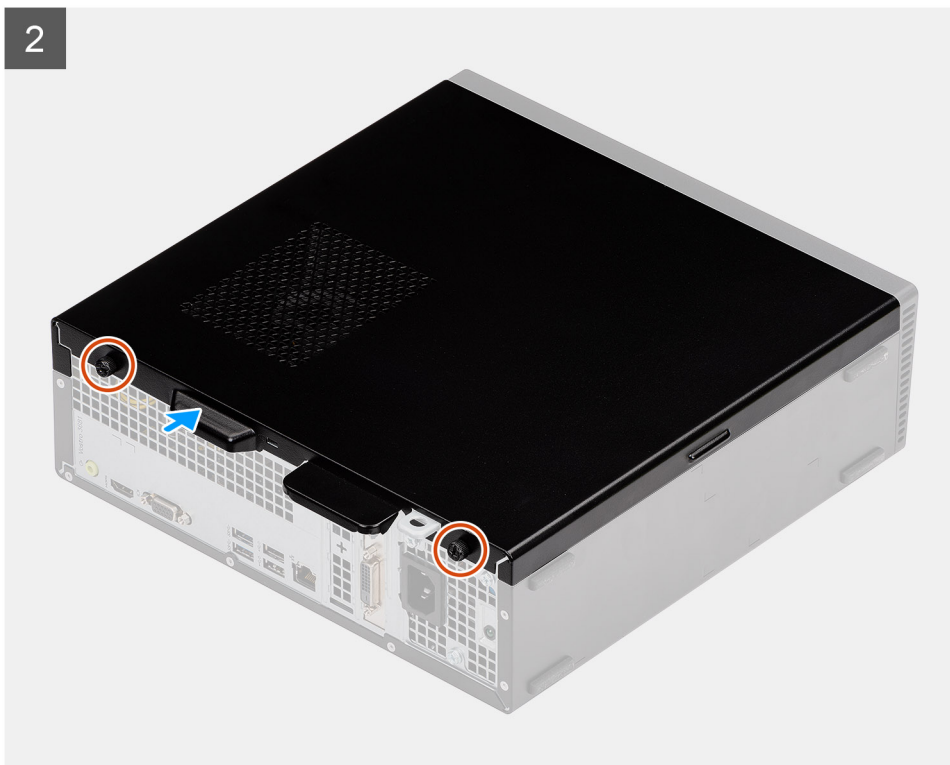
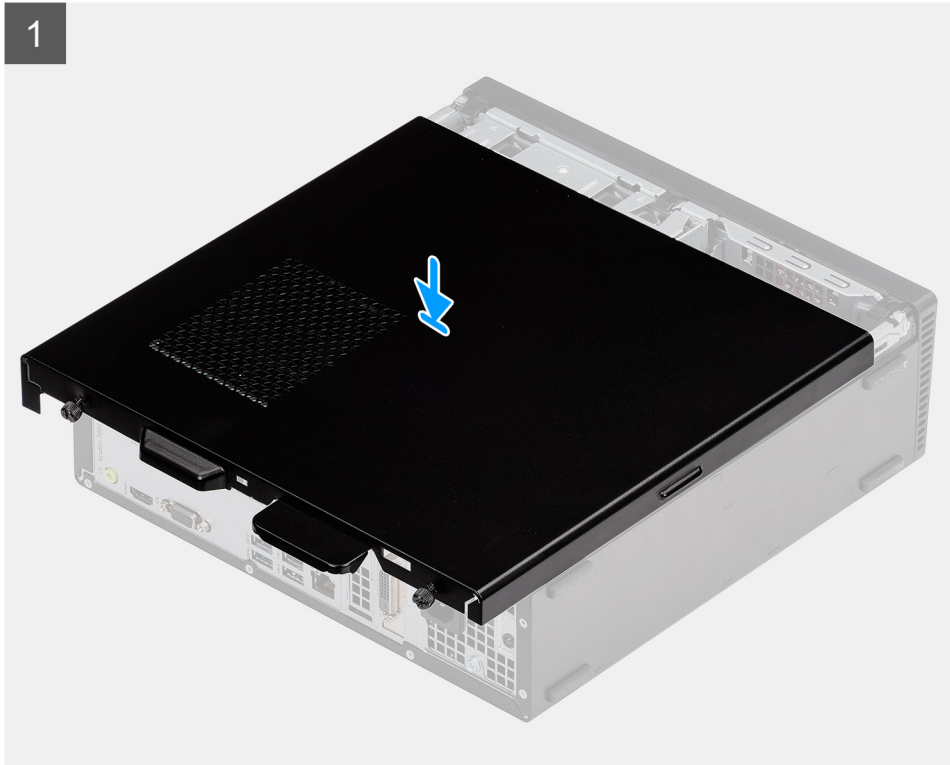

Steps

1. Align the tabs on the side cover with the slots and replace the side cover on the chassis.
2. Slide the side cover towards the front of the unit and tighten the two cap screws to secure the side cover to the chassis.

Next steps

1. Follow the procedure in [After working inside your computer](#).

Bezel

Removing the front bezel

Prerequisites

1. Follow the procedure in [Before working inside your computer](#).
2. Remove the [side cover](#).
3. Place the computer in an upright position.

About this task

The following images indicate the location of the front bezel and provide a visual representation of the removal procedure:

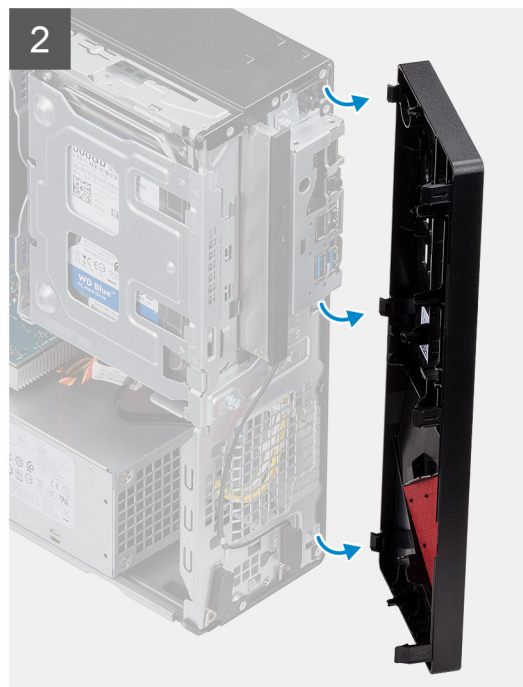
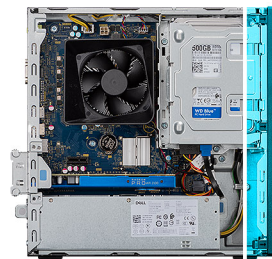

Steps

1. Gently pry and release the front bezel tabs sequentially from the top.
2. Rotate the front cover outward from the chassis.

Installing the front bezel

Prerequisites

If you are replacing a component, remove the existing component before performing the installation procedure.

- Place the computer in an upright position.

About this task

The following images indicate the location of the front bezel and provide a visual representation of the installation procedure:

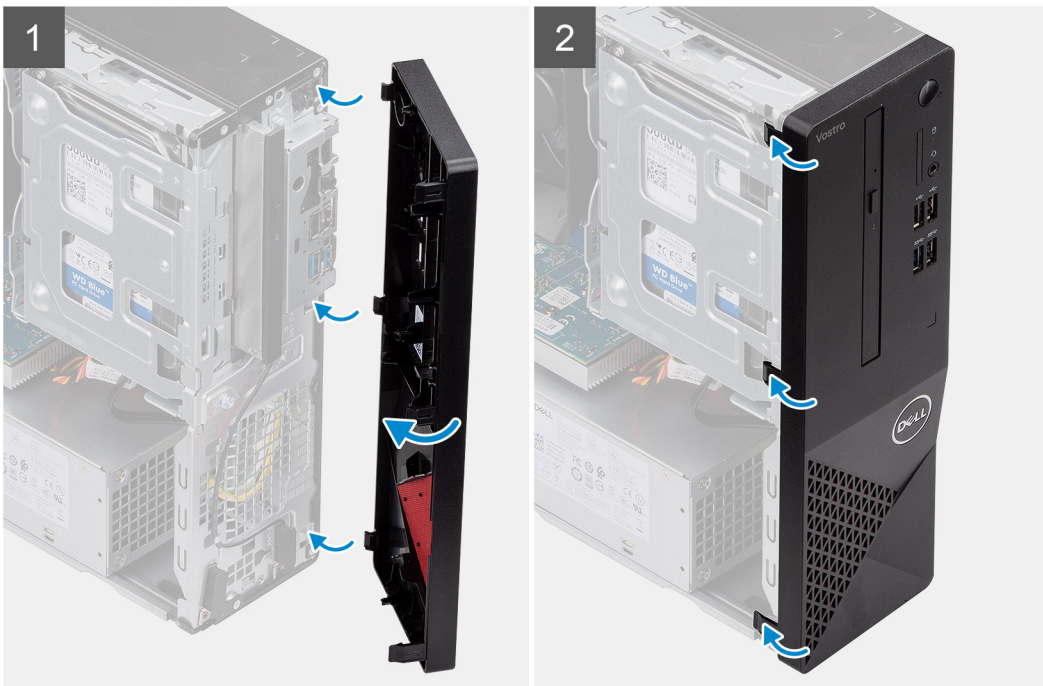
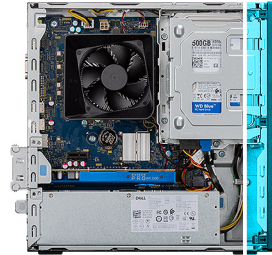

Steps

1. Align the tabs on the bezel with the slots on the chassis.
2. Rotate the front cover towards the chassis and snap it into place.

Next steps

1. Install the [side cover](#).
2. Follow the procedure in [After working inside your computer](#).

3.5 in. Hard disk drive

Removing the 3.5-inch hard drive

Prerequisites

1. Follow the procedure in [Before working inside your computer](#).
2. Remove the [side cover](#).

About this task

The following images indicate the location of the 3.5-inch hard drive and provides a visual representation of the removal procedure:

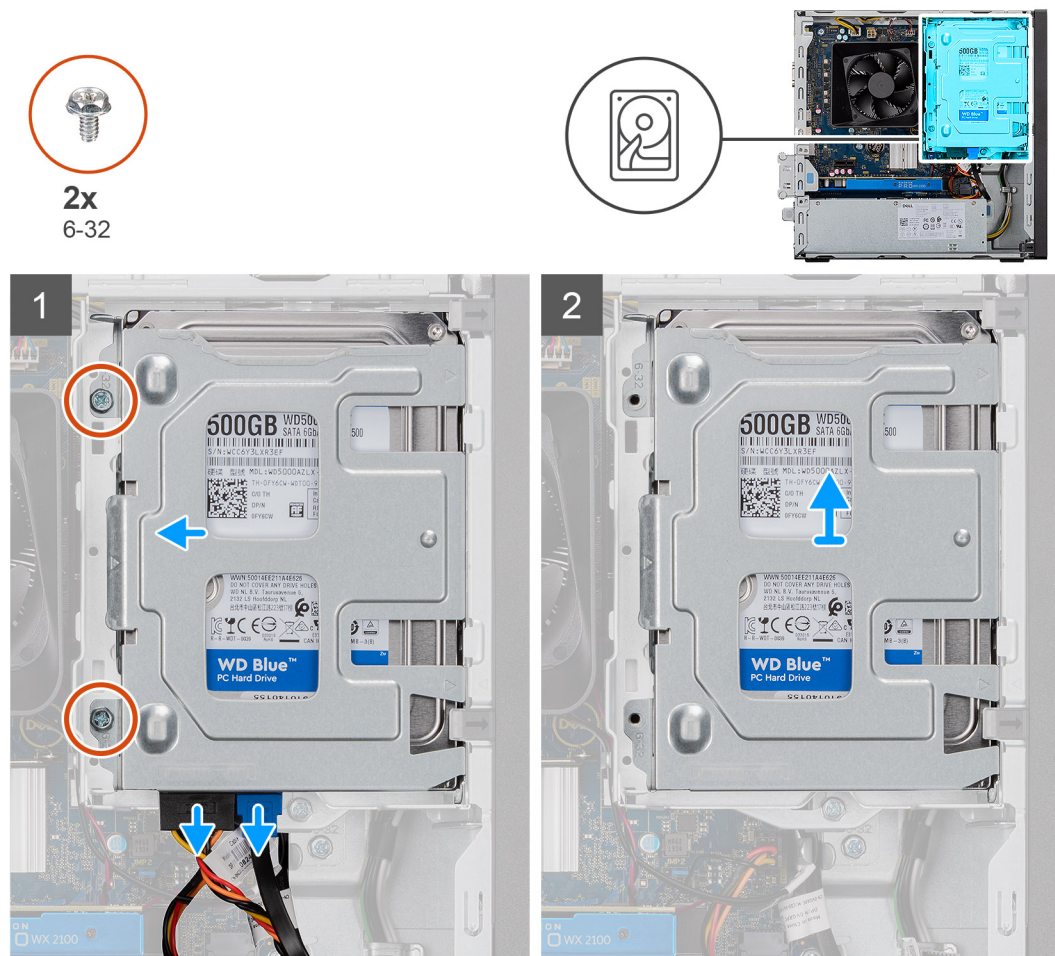

Steps

1. Disconnect the data and power SATA cables from the hard drive and remove the two #6-32 screws.
2. Lift and remove the 3.5 inch hard drive from the bracket.

Installing the 3.5-inch hard drive

Prerequisites

If you are replacing a component, remove the existing component before performing the installation procedure.

About this task

The following images indicate the location of the 3.5-inch hard drive and provides a visual representation of the installation procedure:



2x
6-32

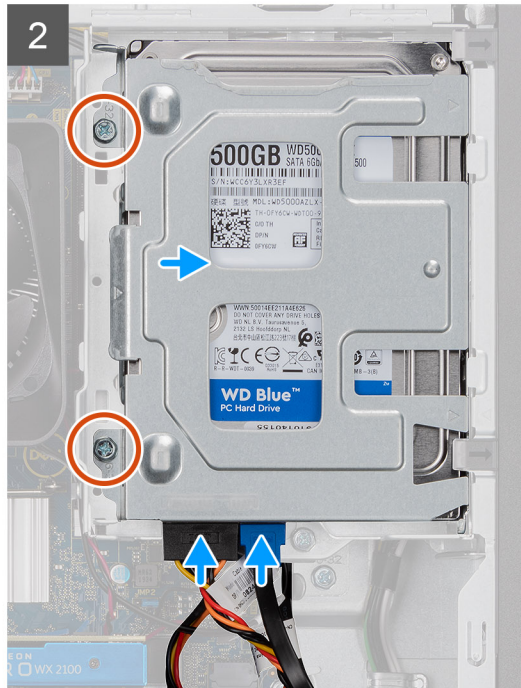
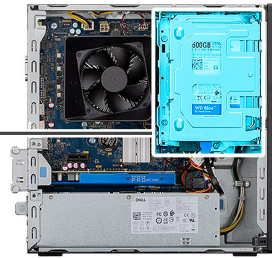

Steps

1. Place the hard drive into the hard-drive bracket and align the tabs on the bracket with the slots on the hard drive.
2. Secure the two #6-32 screws securing the 3.5 in. hard drive to the bracket.

Next steps

1. Install the [side cover](#).
2. Follow the procedure in [After working inside your computer](#).

HDD/ODD Bracket

Removing the HDD/ODD bracket

Prerequisites

1. Follow the procedure in [Before working inside your computer](#).
2. Remove the [side cover](#).
3. Remove the [3.5 in. HDD](#).

About this task

The following image indicates the location of the HDD/ODD bracket and provides a visual representation of the removal procedure.



1x
6-32

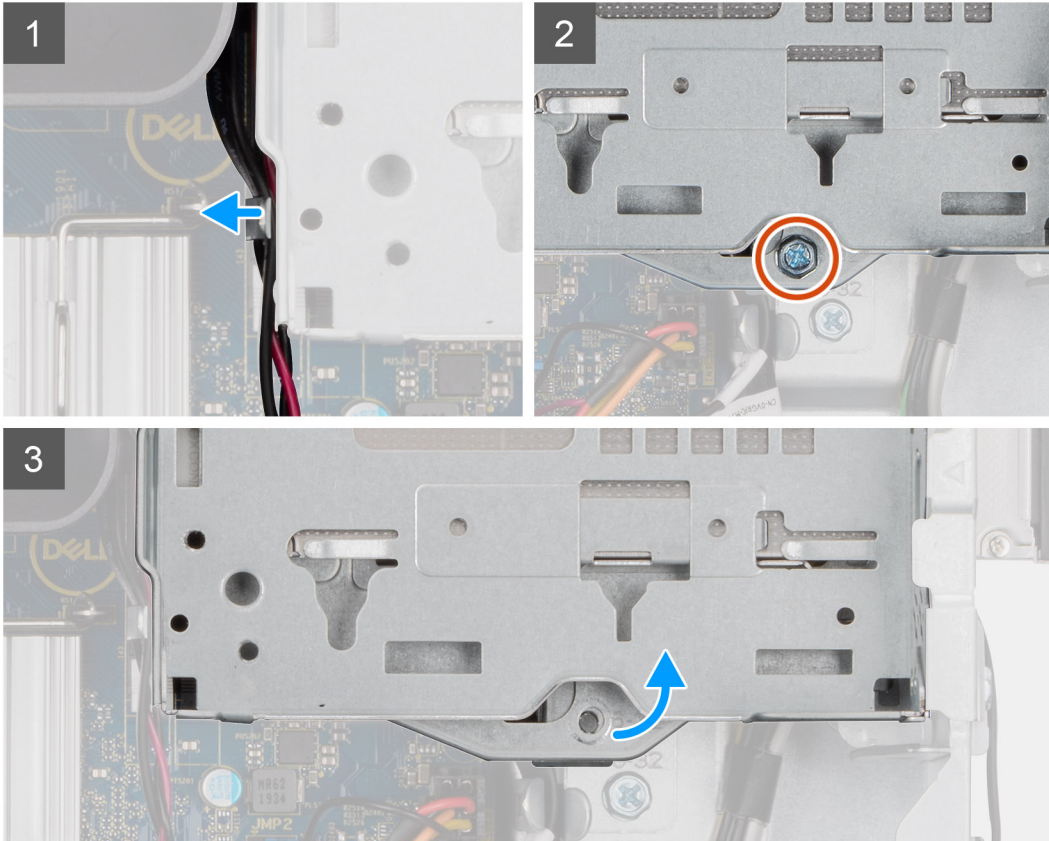

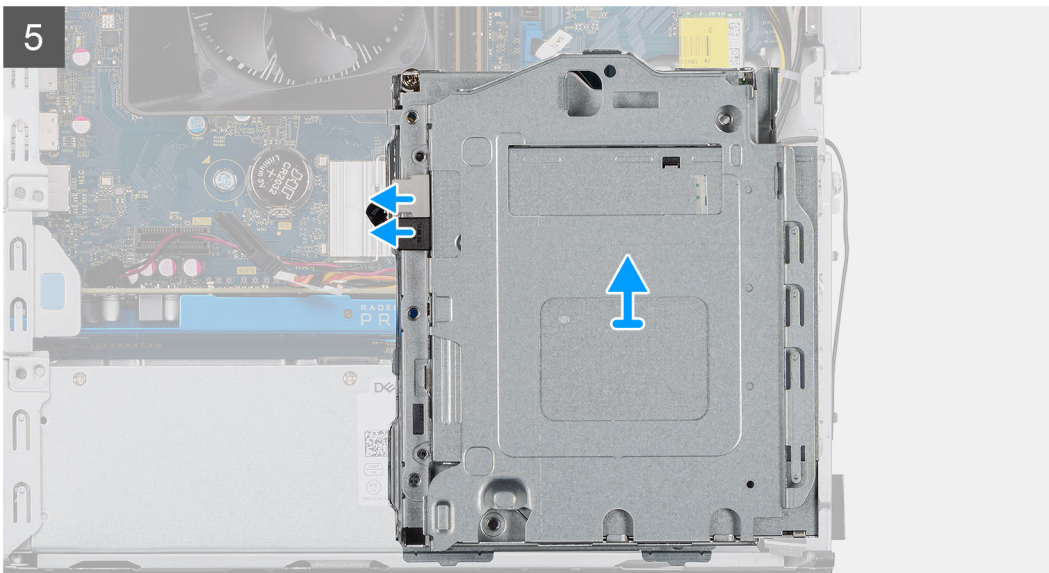
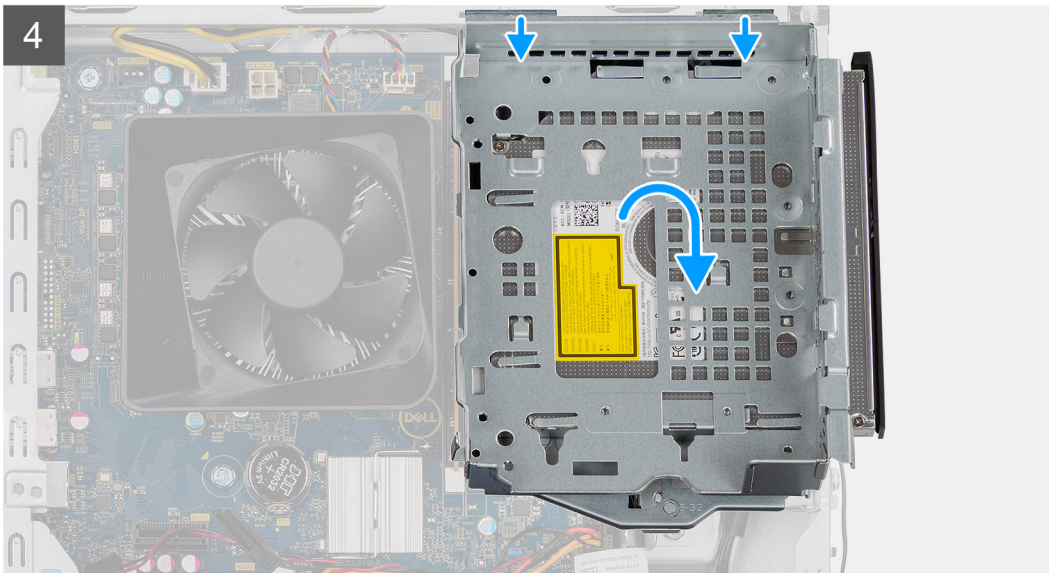

Steps

1. Release the ODD power and SATA cables from tabs on the side of the ODD bracket.
2. Remove the single #6-32 screw securing the ODD bracket to the chassis.
3. Lift the ODD bracket from the chassis.
4. Push the ODD to unlock it.
5. Disconnect the SATA power and data connectors from the ODD.
6. Lift and remove the ODD bracket from the chassis.

Installing the HDD/ODD bracket

Prerequisites

If you are replacing a component, remove the existing component before performing the installation procedure.

About this task

The following images indicate the location of the HDD/ODD bracket and provides a visual representation of the installation procedure:

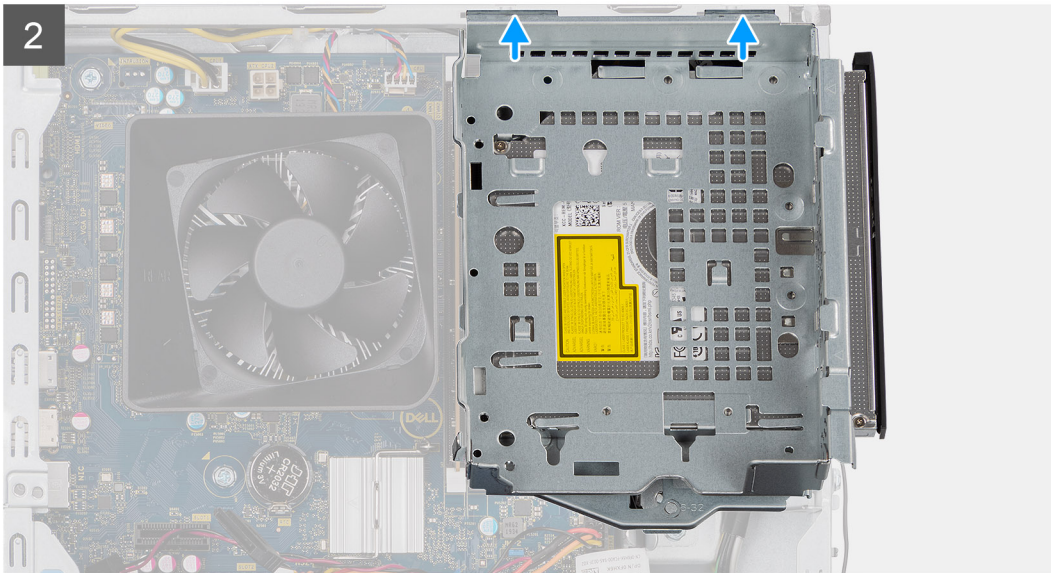
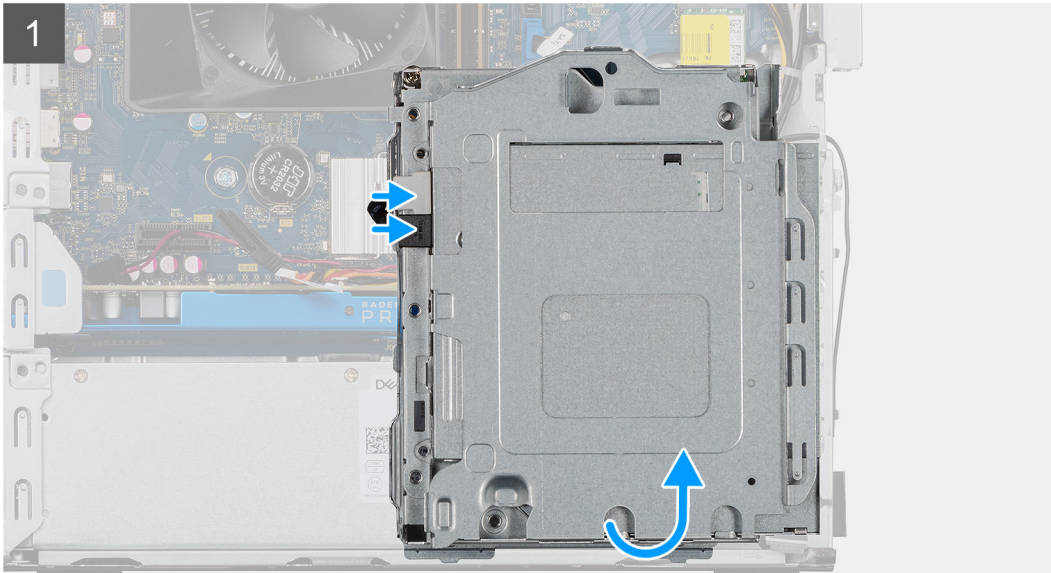



1x
6-32

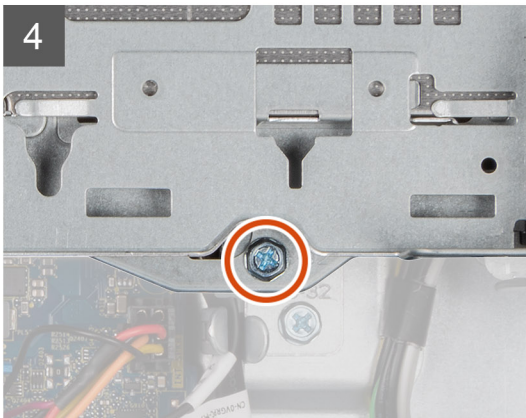

Steps

1. Align and place the ODD bracket on the system unit chassis and connect the ODD SATA and power connectors
2. Push the ODD bracket into the chassis.
3. Snap the ODD bracket aligning the holes on the ODD bracket with that on the chassis.
4. Replace the single #6-32 screw securing the ODD to the chassis.
5. Tuck the power SATA cables along the tabs of the ODD bracket.

Next steps

1. Install the [3.5 in. HDD](#).
2. Install the [side cover](#).
3. Follow the procedure in [After working inside your computer](#).

Optical drive

Removing the Optical Disk Drive

Prerequisites

1. Follow the procedure in [Before working inside your computer](#).
2. Remove the [side cover](#).
3. Remove the [3.5 in. HDD](#).
4. Remove the [HDD/ODD bracket](#).

About this task

The following images indicate the location of the ODD and provides a visual representation of the removal procedure.



1x
M2x3

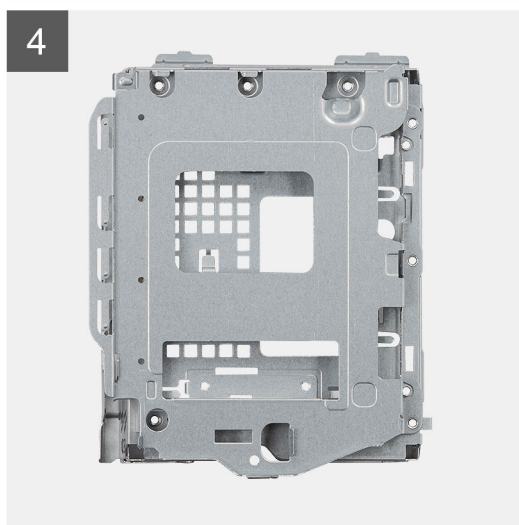
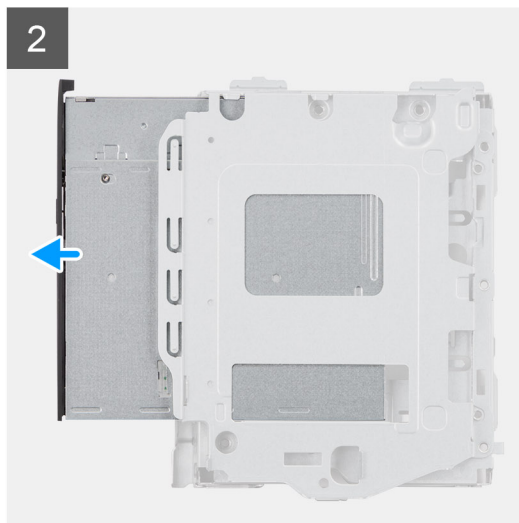
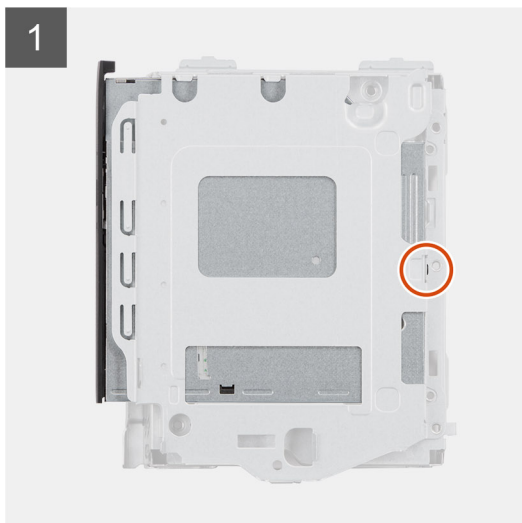

Steps

1. Remove the single M2x3 screw securing the optical drive to the bracket.
2. Remove the optical drive from the bracket.

Installing the Optical Disk Drive

Prerequisites

If you are replacing a component, remove the existing component before performing the installation procedure.

About this task

The following images indicate the location of the Optical Disk Drive and provide a visual representation of the installation procedure:



1x
M2x3

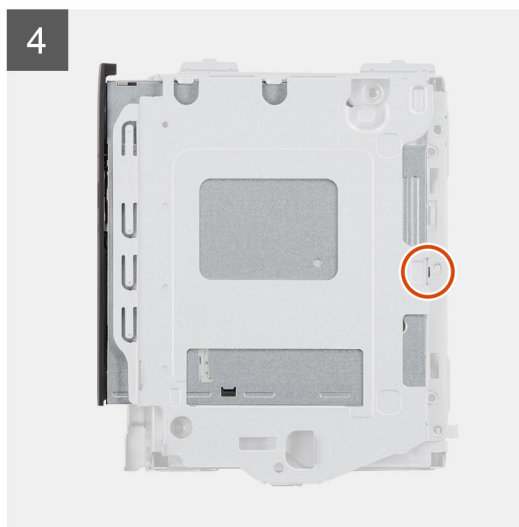
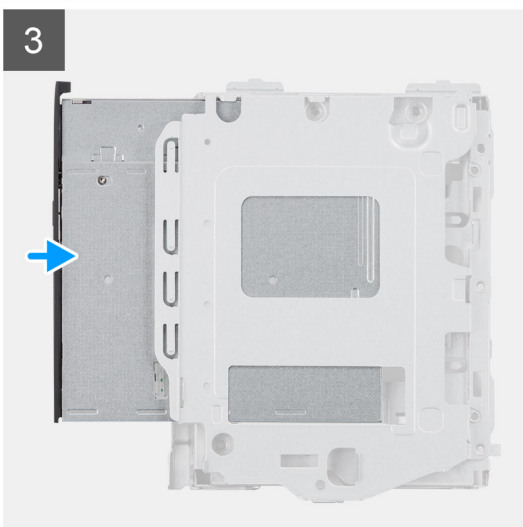
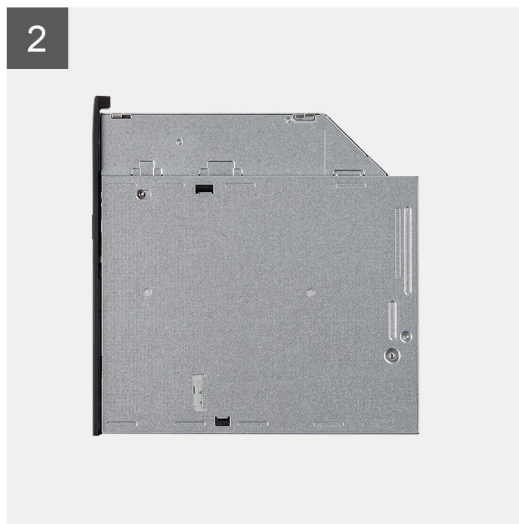
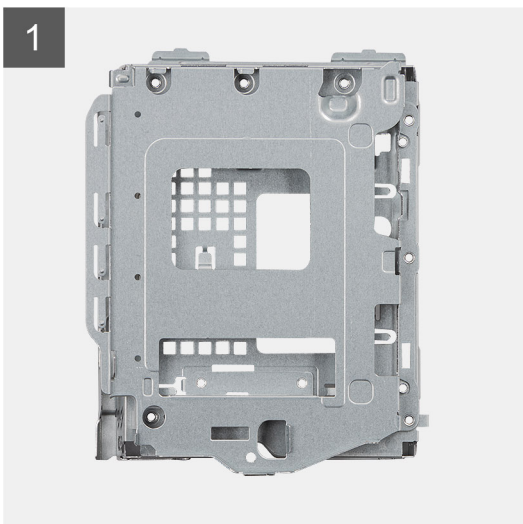

Steps

1. Insert the optical drive into the ODD bracket.
2. Replace the single M2x3 screw securing the optical drive to the bracket.

Next steps

1. Install the [HDD/ODD bracket](#).
2. Install the [3.5 in. HDD](#).
3. Install the [side cover](#).
4. Follow the procedure in [After working inside your computer](#).

Memory module

Removing the memory modules

Prerequisites

1. Follow the procedure in [Before working inside your computer](#).
2. Remove the [side cover](#).
3. Remove the [HDD/ODD bracket](#).

About this task

The following images indicate the location of the memory modules and provide a visual representation of the removal procedure:

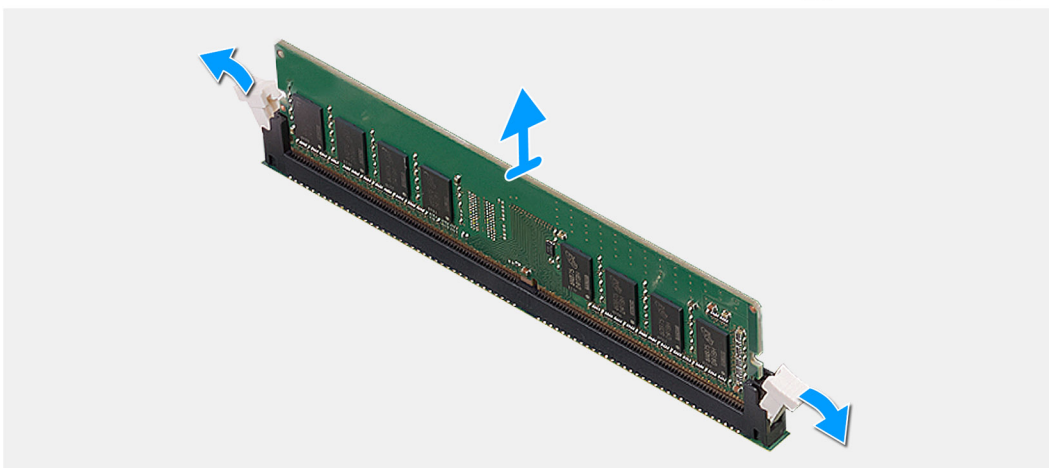
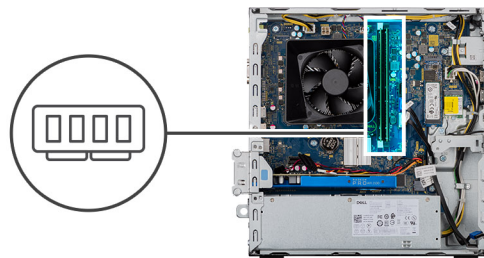

Steps

1. Lay the chassis on the right side.
2. Use your fingertips to carefully spread apart the securing-clips on each end of the memory-module slot.
3. Grasp the memory module near the securing clip, and then gently ease the memory module out of the memory-module slot.

NOTE: Repeat step 2 to step 4 to remove any other memory modules installed in your computer.

NOTE: Note the slot and the orientation of the memory module in order to replace it in the correct slot.

NOTE: If the memory module is difficult to remove, gently ease the memory module back and forth to remove it from the slot.

CAUTION: To prevent damage to the memory module, hold the memory module by the edges. Do not touch the components on the memory module.

Installing the memory modules

Prerequisites

If you are replacing a component, remove the existing component before performing the installation procedure.

About this task

The following images indicate the location of the memory modules and provides a visual representation of the installation procedure.

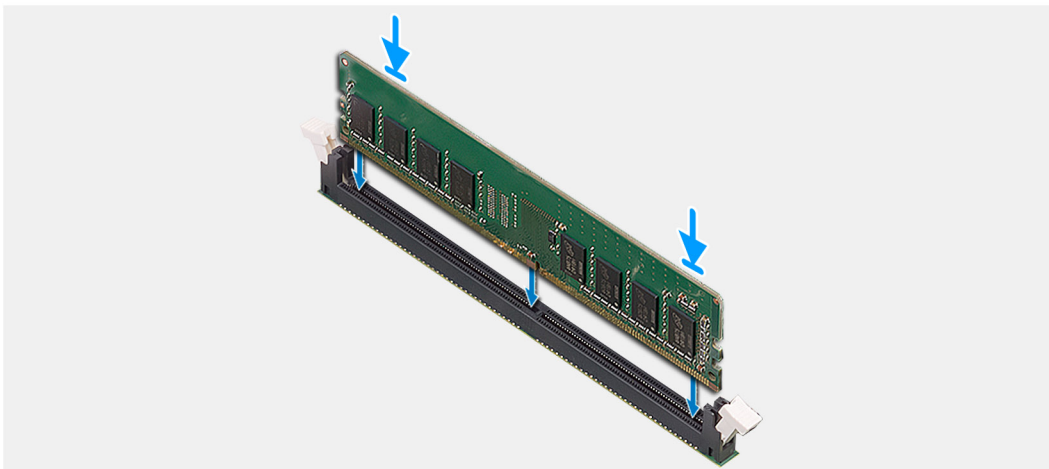
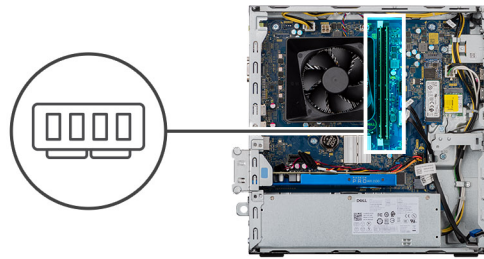

Steps

1. Align the notch on the memory module with the tab on the memory-module slot.
2. Insert the memory module into the memory-module connector until the memory module snaps into position and the securing clip locks in place.

NOTE: The securing clips return to the locked position. If you do not hear the click, remove the memory module and reinstall it.

NOTE: If the memory module is difficult to remove, gently ease the memory module back and forth to remove it from the slot.

NOTE: To prevent damage to the memory module, hold the memory module by the edges. Do not touch the components on the memory module.

Next steps

1. Install the [ODD bracket](#).
2. Install the [side cover](#).
3. Follow the procedure in [After working inside your computer](#).

Graphics card

Removing the graphics card

Prerequisites

1. Follow the procedure in [Before working inside your computer](#).
2. Remove the [side cover](#).

About this task

The following images indicate the location of the graphics card and provides a visual representation of the removal procedure.

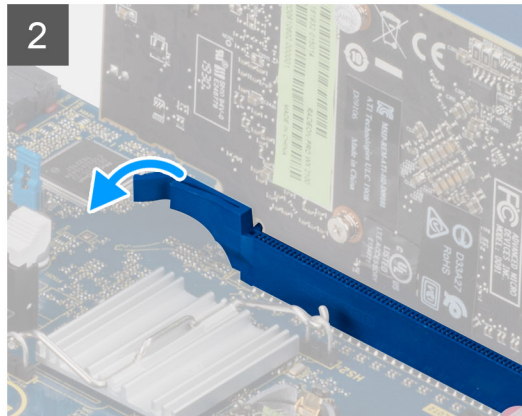
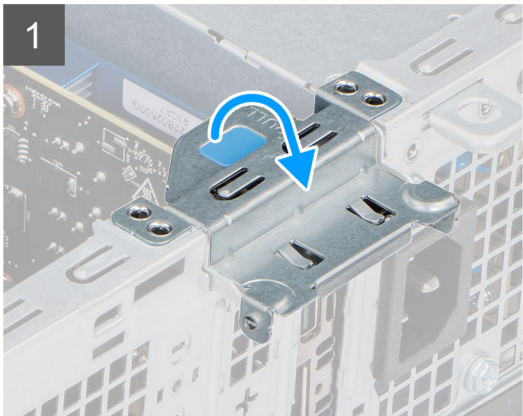
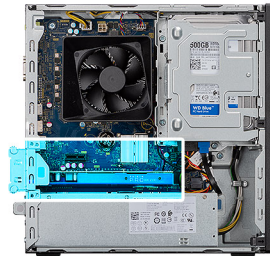

Steps

1. Lift the pull tab to open the PCIe door.
2. Push and hold the securing tab on the graphics-card slot and lift the graphics card from the graphics-card slot.
3. Lift and remove the graphics card from the system board.

Installing the graphics card

Prerequisites

If you are replacing a component, remove the existing component before performing the installation procedure.

About this task

The following images indicate the location of the graphics card and provides a visual representation of the installation procedure.

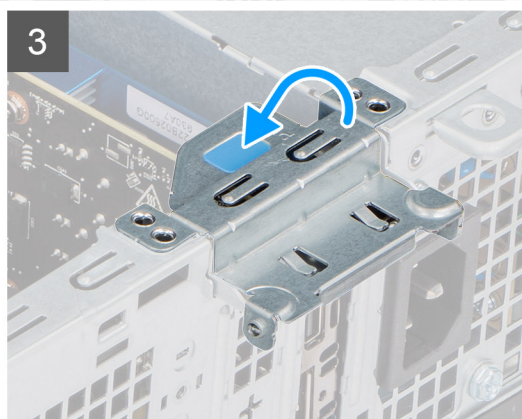
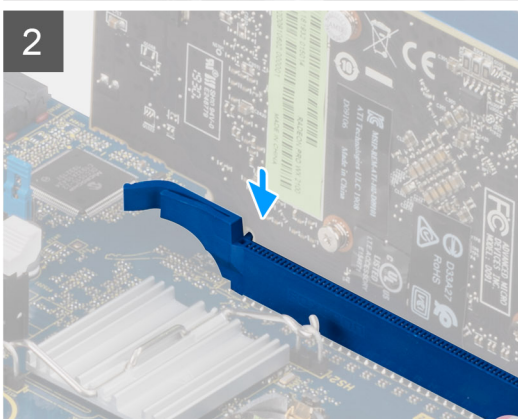
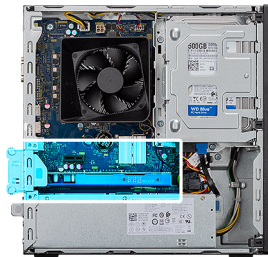

Steps

1. Align the graphics card with the PCI-Express card connector on the system board.
2. Using the alignment post, connect the card in the connector and press down firmly. Ensure that the card is firmly seated.
3. Lift the pull tab to close the PCIe door.

Next steps

1. Install the [side cover](#).
2. Follow the procedure in [After working inside your computer](#).

Coin cell battery

Removing the coin-cell battery

Prerequisites

1. Follow the procedure in [Before working inside your computer](#).

 **CAUTION:** Removing the coin-cell battery resets the BIOS setup program's settings to default. It is recommended that you note the BIOS setup program's settings before removing the coin-cell battery.

2. Remove the [side cover](#).

About this task

The following images indicate the location of the coin-cell battery and provides a visual representation of the removal procedure.

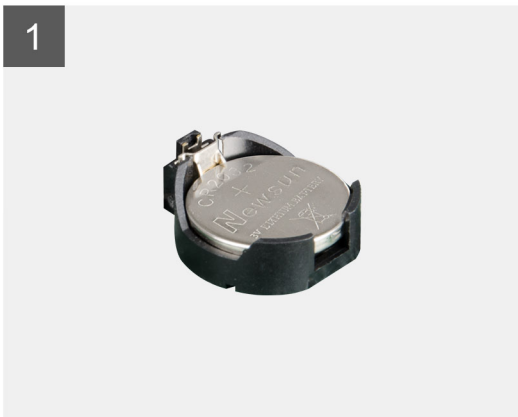
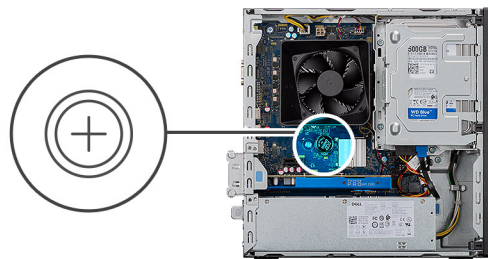

Steps

1. Lay the computer on the right side.
2. Push the coin-cell battery-release lever on the coin-cell battery socket to release the coin-cell battery out of the socket.
3. Remove the coin-cell battery.

Installing the coin-cell battery

Prerequisites

If you are replacing a component, remove the existing component before performing the installation procedure.

About this task

The following images indicate the location of the coin-cell battery and provides a visual representation of the installation procedure.

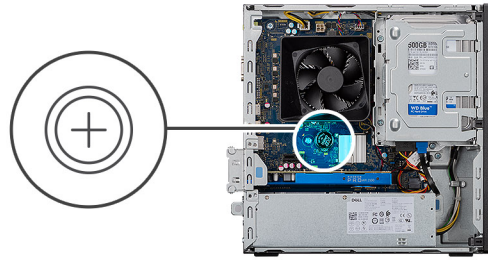

Insert the coin-cell battery into the socket with the positive side (+) labeled facing up and snap the battery in the socket.

Next steps

1. Install the [side cover](#).
2. Follow the procedure in [After working inside your computer](#).

M.2 2230 Solid state drive

Removing the 2230 solid-state drive

Prerequisites

1. Follow the procedure in [Before working inside your computer](#).
2. Remove the [side cover](#).
3. Remove the [HDD/ODD bracket](#).

About this task

The following images indicate the location of the 2230 solid-state drive and provides a visual representation of the removal procedure.



1x
M2x3

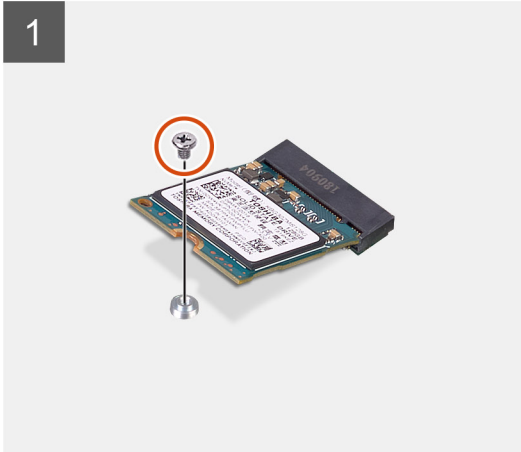
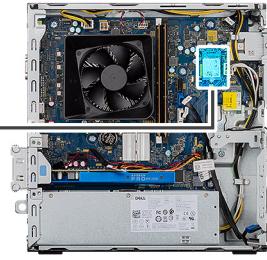

Steps

1. Remove the screw (M2x3) that secures the 2230 solid-state drive to the system board.
2. Slide and lift the solid-state drive from the M.2 card slot on the system board.

Installing the 2230 solid-state drive

Prerequisites

CAUTION: Solid-state drives are fragile. Exercise care when handling the solid-state drive.

If you are replacing a component, remove the existing component before performing the installation procedure.

About this task

The following images indicate the location of the solid-state drive and provides a visual representation of the installation procedure.



1x
M2x3

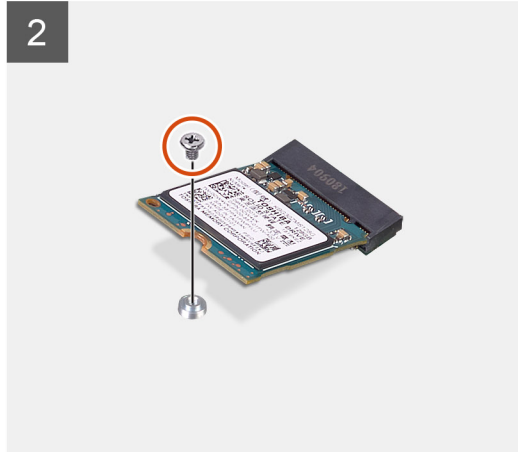
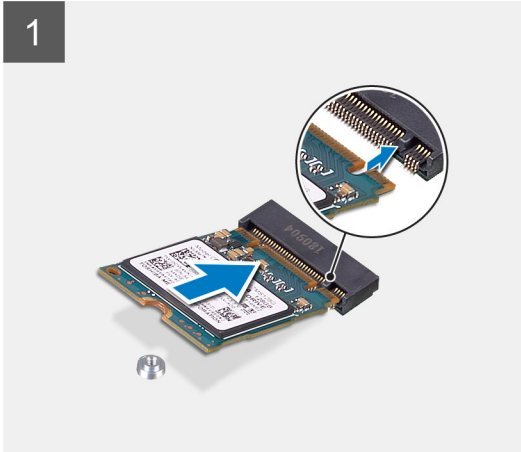
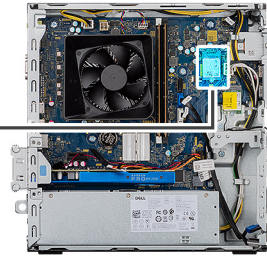

Steps

1. Locate the notch on the 2230 solid-state drive.
2. Align the notch on the 2230 solid-state drive with the tab on the M.2 card slot.
3. Slide the 2230 solid-state drive into the M.2 card slot on the system board.
4. Replace the screw (M2x3) that secures the 2230 solid-state drive to the system board.

Next steps

1. Install the [HDD/ODD bracket](#).
2. Install the [side cover](#).
3. Follow the procedure in [After working inside your computer](#).

M.2 2280 Solid state drive

Removing the 2280 solid-state drive

Prerequisites

1. Follow the procedure in [Before working inside your computer](#).
2. Remove the [side cover](#).
3. Remove the [HDD/ODD bracket](#).

About this task

The following images indicate the location of the 2280 solid-state drive and provide a visual representation of the removal procedure.



1x
M2x3

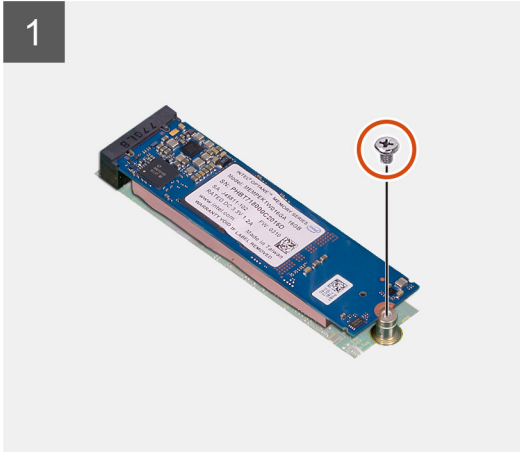
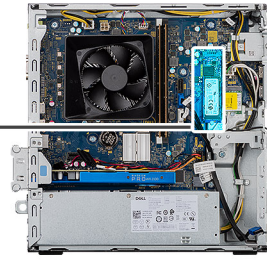

Image:

Steps

1. Remove the screw (M2x3) that secures the 2280 solid-state drive to the system board.
2. Slide and lift the solid-state drive from the M.2 card slot on the system board.

Installing the 2280 solid-state drive

Prerequisites

CAUTION: Solid-state drives are fragile. Exercise care when handling the solid-state drive.

If you are replacing a component, remove the existing component before performing the installation procedure.

About this task

The following images indicate the location of the 2280 solid-state drive and provides a visual representation of the installation procedure.



1x
M2x3

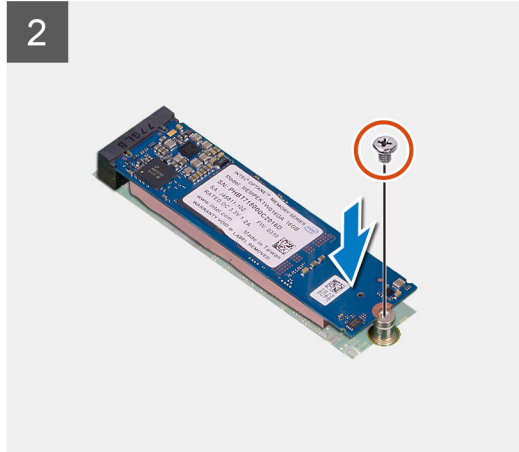
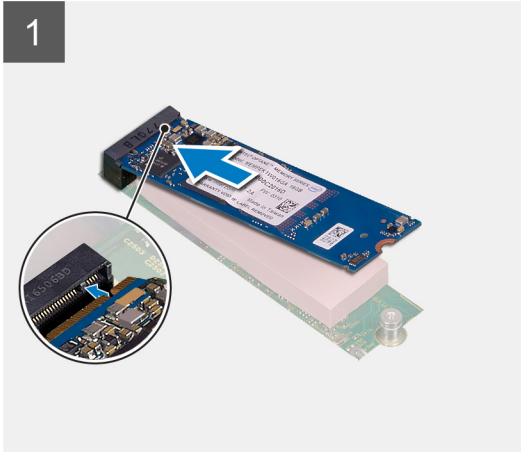
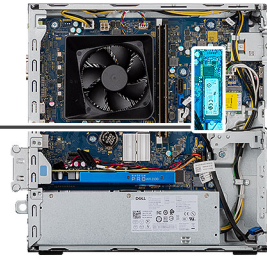

Steps

1. Locate the notch on the 2280 solid-state drive.
2. Align the notch on the 2280 solid-state drive with the tab on the M.2 card slot.
3. Slide the 2230 solid-state drive into the M.2 card slot on the system board.
4. Replace the screw (M2x3) that secures the 2230 solid-state drive to the system board.

Next steps

1. Install the [HDD/ODD bracket](#).
2. Install the [side cover](#).
3. Follow the procedure in [After working inside your computer](#).

WLAN Card

Removing the WLAN card

Prerequisites

1. Follow the procedure in [Before working inside your computer](#).
2. Remove the [side cover](#).
3. Remove the [ODD bracket](#).

About this task

The following images indicate the location of the wireless card and provides a visual representation of the removal procedure.



1x
M2x3

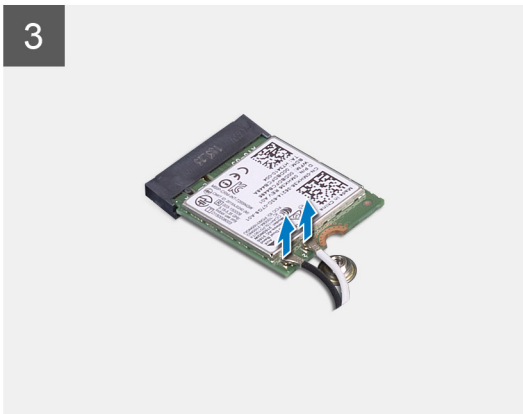
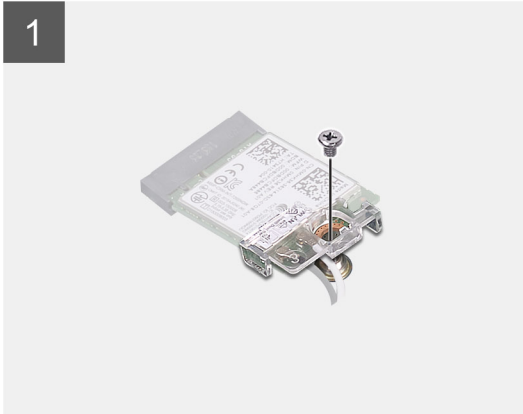
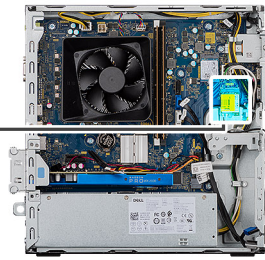

Steps

1. Remove the single (M2x3) screw that secures the wireless card to the system board.
2. Slide and lift the wireless-card bracket off the wireless card.
3. Disconnect the antenna cables from the wireless card.
4. Slide and remove the wireless card at an angle from the wireless-card slot.

Installing the WLAN card

Prerequisites

If you are replacing a component, remove the existing component before performing the installation procedure.

 **NOTE:** To avoid damage to the wireless card, do not place any cables under it.

About this task

The following images indicate the location of the wireless card and provide a visual representation of the installation procedure:



1x
M2x3

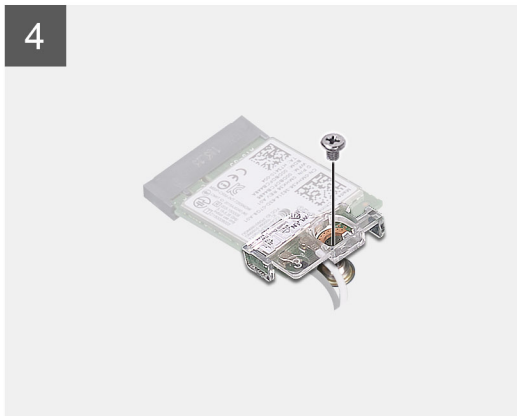
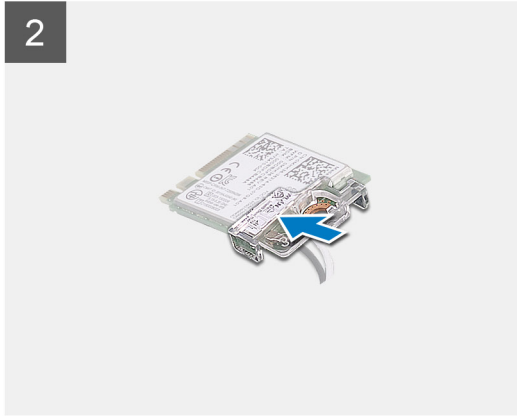
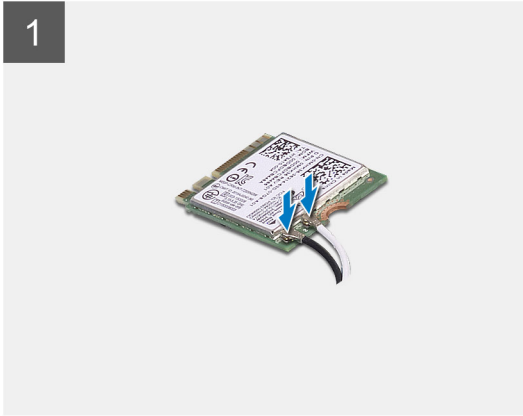
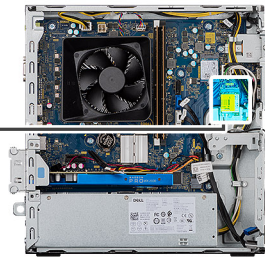

Steps

1. Connect the antenna cables to the WLAN card.
The following table provides the antenna-cable color scheme for the wireless card supported by your computer.

Table 3. Antenna-cable color scheme

Connectors on the wireless card	Antenna-cable color
Main (white triangle)	White
Auxiliary (black triangle)	Black

2. Slide and place the wireless card bracket on the antennae connectors on the WLAN card.
3. Align the notch on the wireless card with the tab on the wireless-card slot.
4. Slide the wireless card at an angle into the wireless-card slot of the system board.
5. Replace the single (M2x3) screw that secures the wireless card to the system board.

Next steps

1. Install the [ODD bracket](#)
2. Install the [side cover](#).
3. Follow the procedure in [After working inside your computer](#).

SD card

Removing the media card reader

Prerequisites

1. Follow the procedure in [Before working inside your computer](#).
2. Remove the [side cover](#).
3. Remove the [front bezel](#).
4. Remove the [HDD/ODD bracket](#).

About this task

The following images indicate the location of the front cover and provide a visual representation of the removal procedure.



2x
M6x32

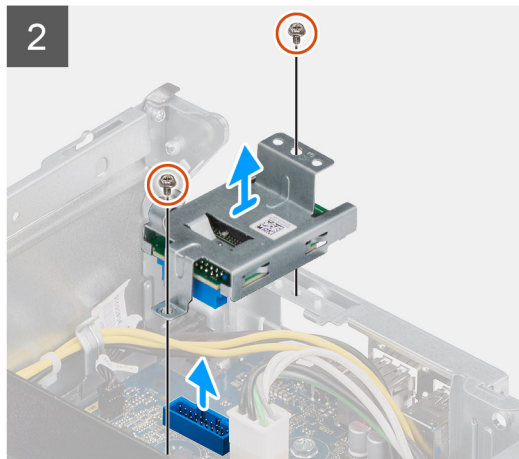
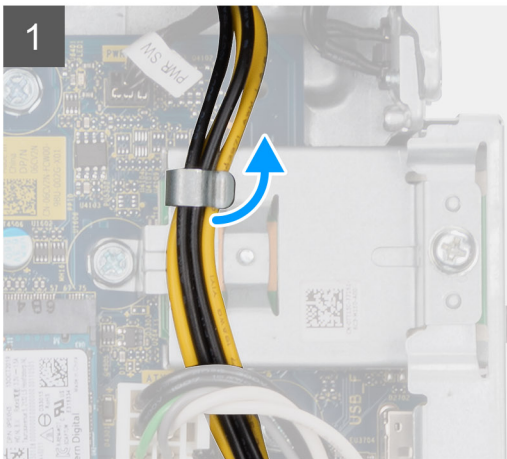
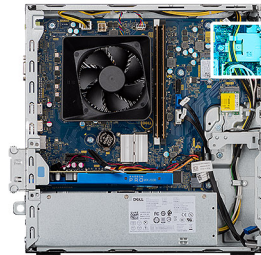

Steps

1. Unroute the PSU power cable from over the SD card reader.
2. Remove the two M3x5 screws securing the SD card reader to the chassis.
3. Lift and remove the SD card reader from the system board.

Installing the media card reader

Prerequisites

About this task

The following images indicate the location of the media card reader and provide a visual representation of the installation procedure.



2x
M6x32

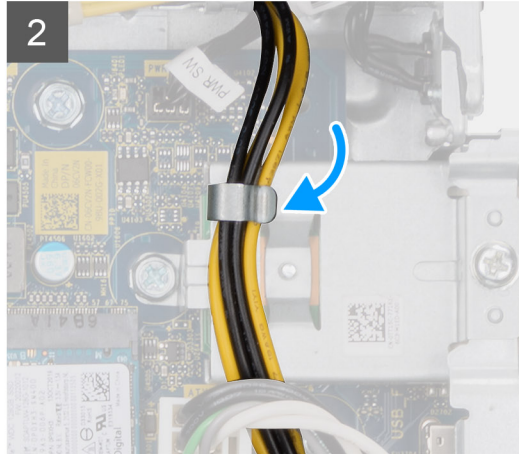
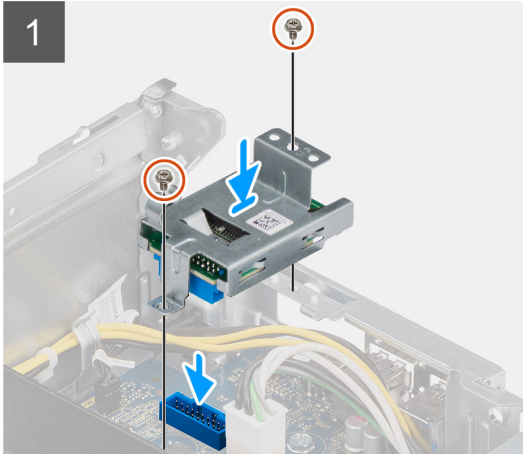
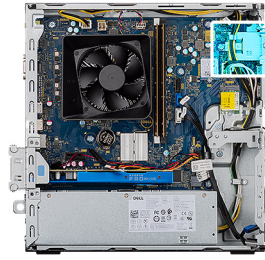

Steps

1. Place the SD card reader on the system board ensuring the SD card reader sits flush on the connector on the system board.
2. Replace the two M3x5 screws securing the SD card reader to the system board.
3. Route the PSU power cable from over the SD card reader.

Next steps

1. Install the [HDD/ODD Bracket](#).
2. Install the [front bezel](#).
3. Install the [side cover](#).
4. Follow the procedure in [After working inside your computer](#).

Power supply unit

Removing the power-supply unit

Prerequisites

1. Follow the procedure in [Before working inside your computer](#).
2. Remove the [side cover](#).
3. Remove the [front bezel](#).
4. Remove the [HDD/ODD bracket](#).

i **NOTE:** Note the routing of all cables as you remove them so that you can route them correctly while you are replacing the power-supply unit.

About this task

The following images indicate the location of the power-supply unit and provides a visual representation of the removal procedure.



6x
6x32

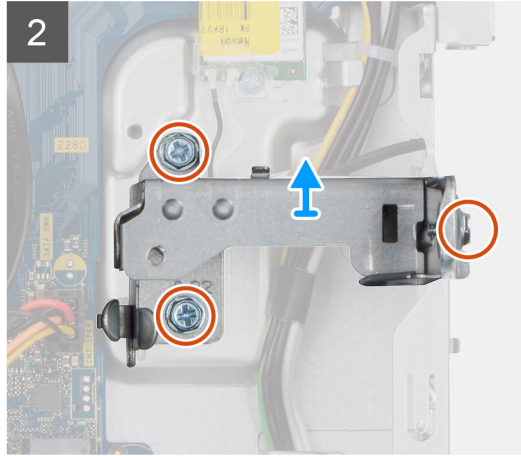
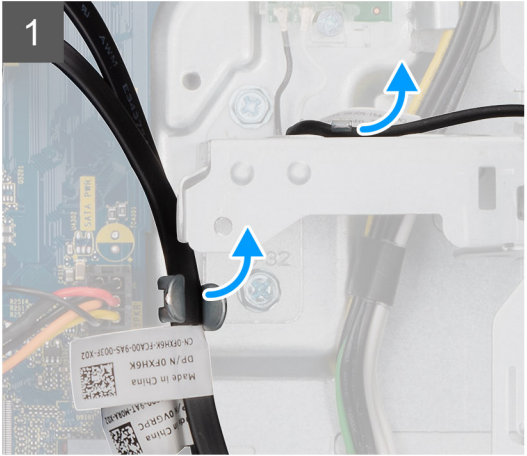

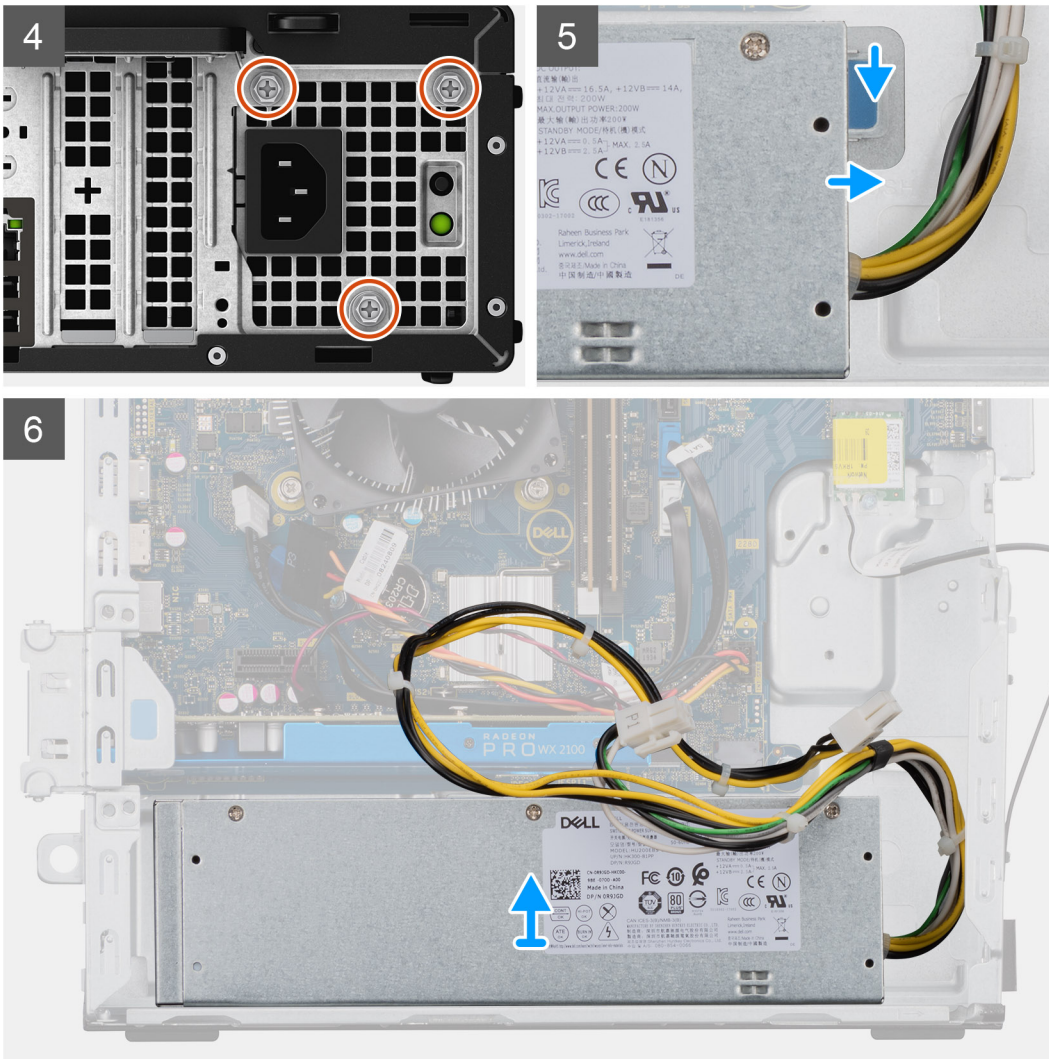

Steps

1. Lay the computer on the right side.
2. Disconnect the power cables from the system board and remove them from the routing guides on the chassis.
3. Remove the three (#6-32) screws that secure the power-supply unit to the chassis.
4. Press the securing clip and slide the power-supply unit away from the back of the chassis.
5. Lift the power-supply unit off the chassis.

Installing the power-supply unit

Prerequisites

If you are replacing a component, remove the existing component before performing the installation procedure.

⚠ WARNING: The cables and ports on the back of the power-supply unit are color-coded to indicate the different power wattage. Ensure that you plug in the cable to the correct port. Failure to do so may result in damaging the power-supply unit and/or system components.

About this task

The following images indicate the location of the power-supply unit and provides a visual representation of the installation procedure.

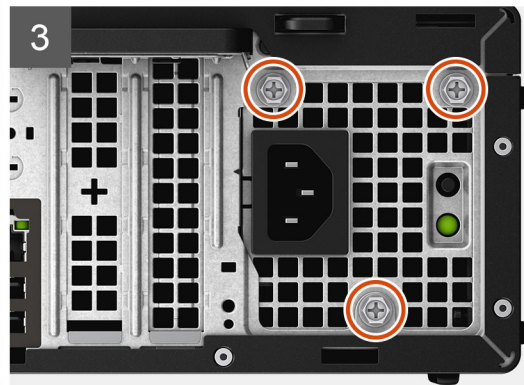
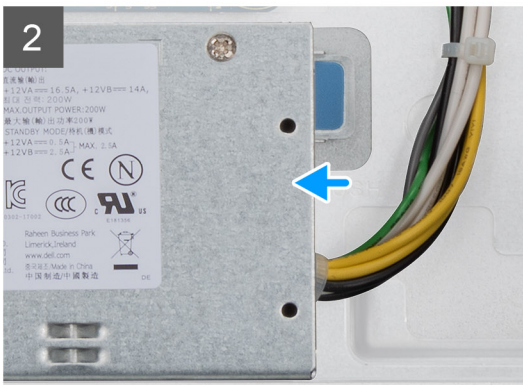

3



6x
6x32



5

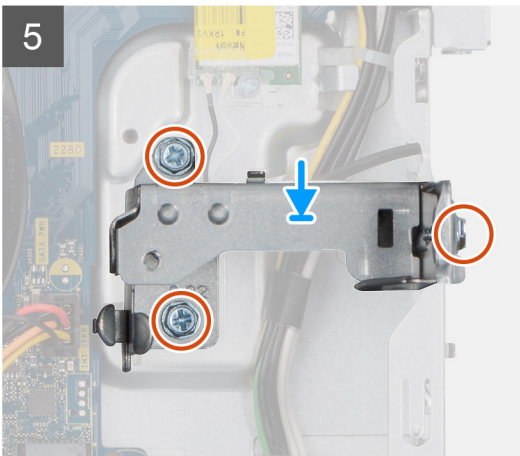

6

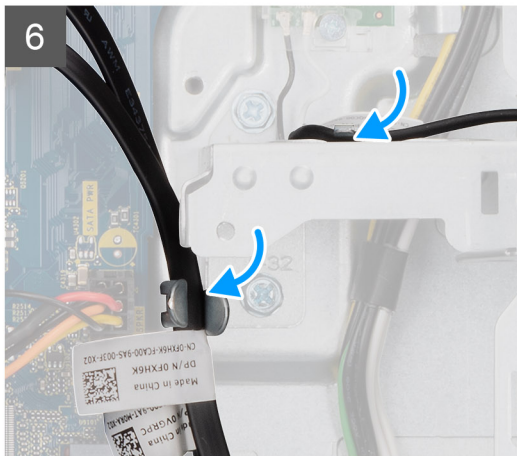

Steps

1. Slide the power-supply unit into the chassis until the securing tab snaps into position.
2. Replace the three screws (#6-32) that secure the power-supply unit to the chassis.
3. Route the power cable through the routing guides on the chassis and connect the power cables to their respective connectors on the system board.

Next steps

1. Install the [HDD/ODD Bracket](#).
2. Install the [front bezel](#).
3. Install the [side cover](#).
4. Follow the procedure in [After working inside your computer](#).

Heatsink assembly

Removing the heatsink assembly

Prerequisites

1. Follow the procedure in [Before working inside your computer](#).

 **WARNING:** The heat sink may become hot during normal operation. Allow sufficient time for the heat sink to cool before you touch it.

 **CAUTION:** For maximum cooling of the processor, do not touch the heat transfer areas on the heat sink. The oils in your skin can reduce the heat transfer capability of the thermal grease.

2. Remove the [side cover](#).

About this task

The following images indicate the location of the processor fan and 65 W heat-sink assembly and provide a visual representation of the removal procedure.

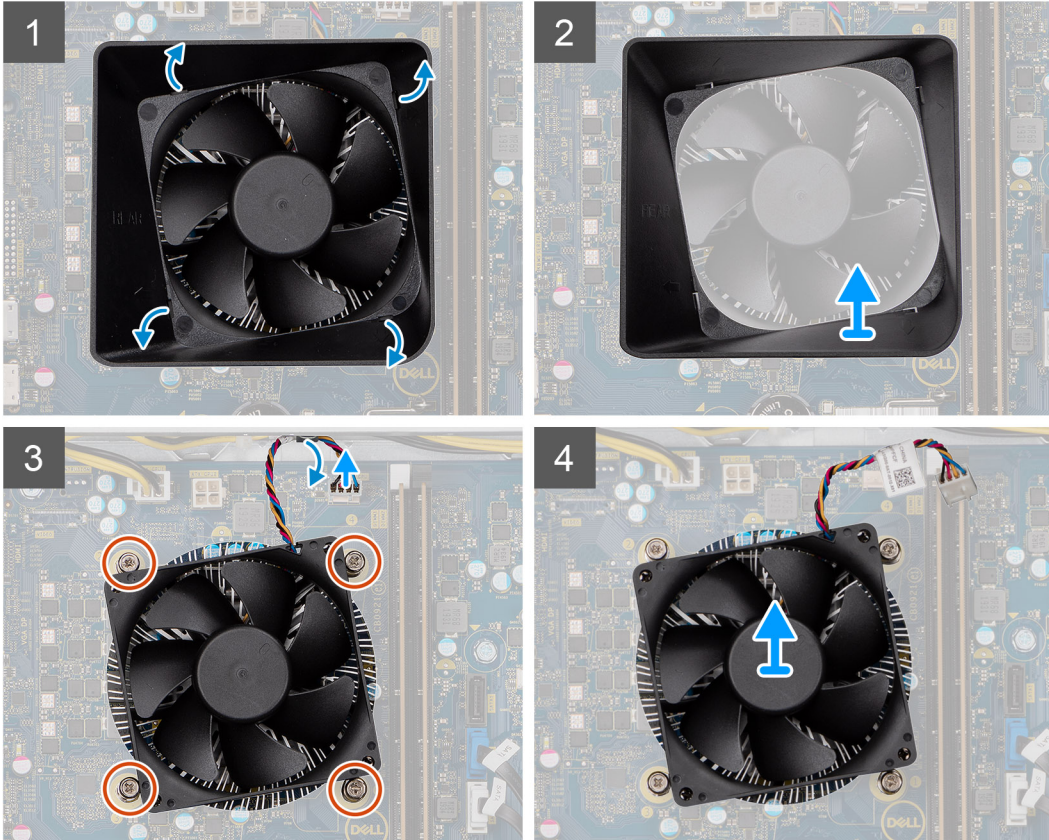
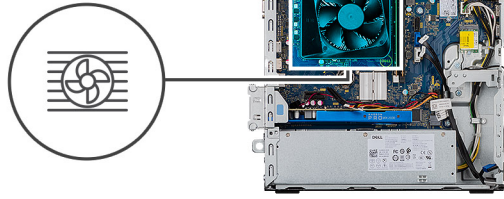

Steps

1. Insert a flat head screw driver along the four marked edges of the fan shroud and gently push towards the fan to disengage the fan shroud from the heatsink assembly.
2. Lift and remove the fan shroud from the system unit.
3. Disconnect the processor-fan cable from the system board.
4. Loosen the four captive screws in reverse sequential order (4->3->2->1) that secure the processor fan and heat-sink assembly to the system board.
5. Lift the processor fan and heat-sink assembly off the system board.

Installing the heatsink assembly

Prerequisites

If you are replacing a component, remove the existing component before performing the installation procedure.

CAUTION: If either the processor or the heat sink is replaced, use the thermal grease that is provided in the kit to ensure that thermal conductivity is achieved.

About this task

The following images indicate the location of the processor fan and 95 W heat-sink assembly and provide a visual representation of the installation procedure.

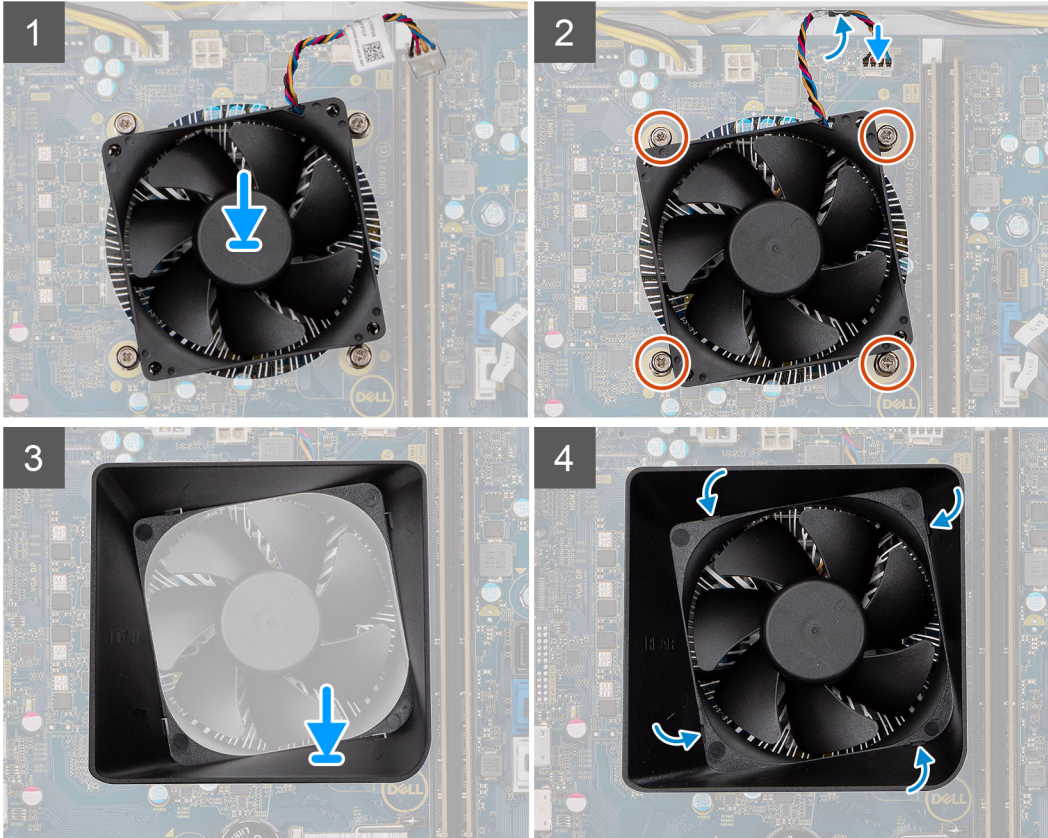
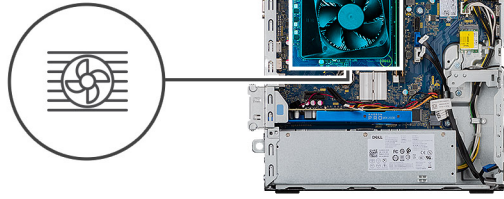

Steps

1. Align the screw holes on the processor fan and heat-sink assembly with the screw holes on the system board.
2. In the sequential order (1->2->3->4), tighten the captive screws that secure the processor fan and heat-sink assembly to the system board.
3. Connect the processor-fan cable to the system board.
4. Replace the fan shroud on the heat-sink assembly along the marked orientation and snap it into place.

Next steps

1. Install the [side cover](#).
2. Follow the procedure in [After working inside your computer](#).

Processor

Removing the processor

Prerequisites

1. Follow the procedure in [Before working inside your computer](#).
2. Remove the [side cover](#).

3. Remove the [heatsink assembly](#).

NOTE: The processor might still be hot after the computer is shut down. Allow the processor to cool down before removing it.

About this task

The following images indicate the location of the processor and provides a visual representation of the removal procedure:

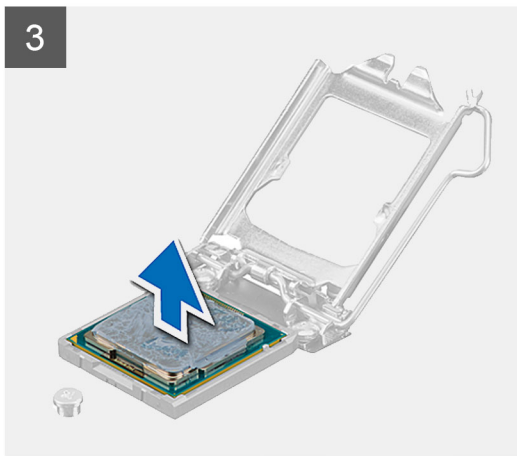
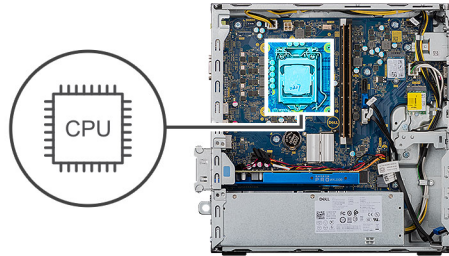

Steps

1. Press the release lever down and then push it away from the processor to release it from the securing tab.
2. Extend the release lever completely and open the processor cover.

CAUTION: When removing the processor, do not touch any of the pins inside the socket or allow any objects to fall on the pins in the socket.

3. Gently lift the processor from the processor socket.

Installing the processor

Prerequisites

If you are replacing a component, remove the existing component before performing the installation procedure.

About this task

The following images indicate the location of the processor and provides a visual representation of the installation procedure:

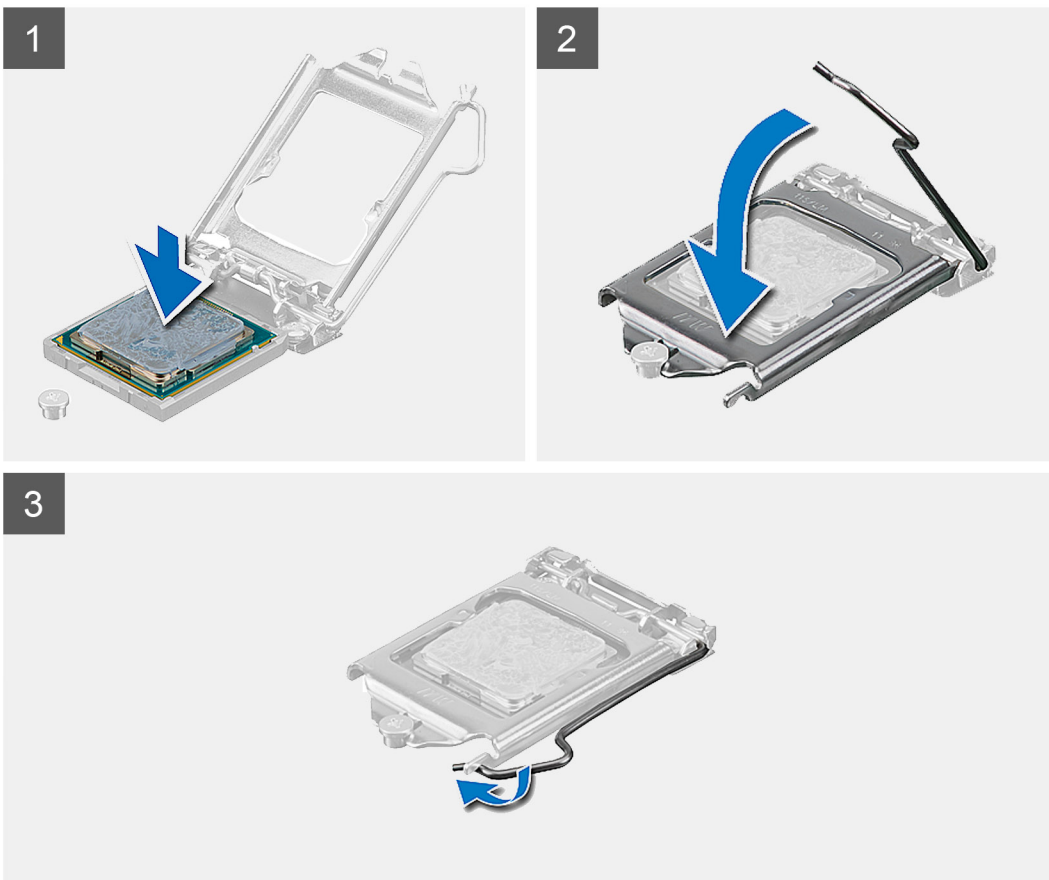
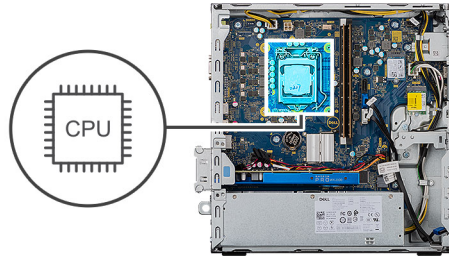

Steps

1. Ensure that the release lever on the processor socket is fully extended in the open position.

NOTE: The pin-1 corner of the processor has a triangle that aligns with the triangle on the pin-1 corner on the processor socket. When the processor is properly seated, all four corners are aligned at the same height. If one or more corners of the processor are higher than the others, the processor is not seated properly.

2. Align the notches on the processor with the tabs on the processor socket and place the processor in the processor socket.

CAUTION: Ensure that the processor-cover notch is positioned underneath the alignment post.

3. When the processor is fully seated in the socket, pivot the release-lever down and place it under the tab on the processor cover.

Next steps

1. Install the [heatsink assembly](#).
2. Install the [side cover](#).
3. Follow the procedure in [After working inside your computer](#).

System board

Removing the system board

Prerequisites

1. Follow the procedure in [Before working inside your computer](#).
 - NOTE:** Your computer's Service Tag is stored in the system board. You must enter the Service Tag in the BIOS setup program after you replace the system board.
 - NOTE:** Replacing the system board removes any changes that you have made to the BIOS using the BIOS setup program. You must make the appropriate changes again after you replace the system board.
 - NOTE:** Before disconnecting the cables from the system board, note the location of the connectors so that you can reconnect the cables correctly after you replace the system board.
2. Remove the [side cover](#).
3. Remove the [front bezel](#).
4. Remove the [HDD/ODD bracket](#).
5. Remove the [optical disk drive](#).
6. Remove the [memory modules](#).
7. Remove the [graphics card](#).
8. Remove the [solid-state drive/Intel Optane memory module](#).
9. Remove the [wireless card](#).
10. Remove the [media card reader](#).
11. Remove the [processor fan and heat-sink assembly](#).
12. Remove the [processor](#).

About this task

The following images indicate the location of the system board and provides a visual representation of the removal procedure.

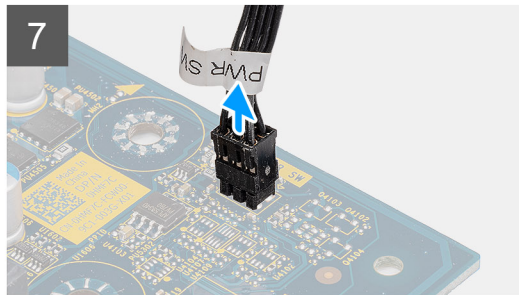
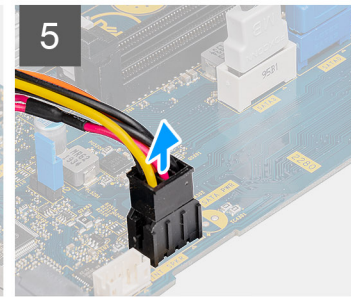
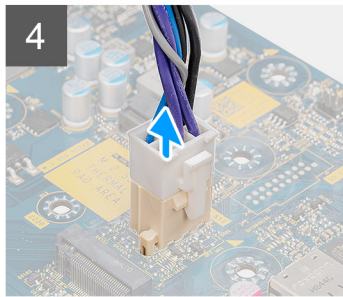
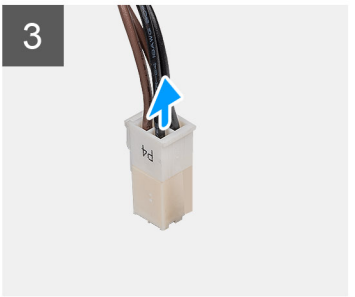
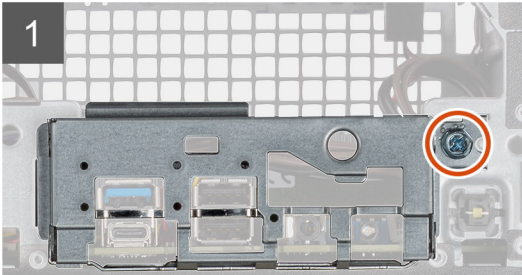
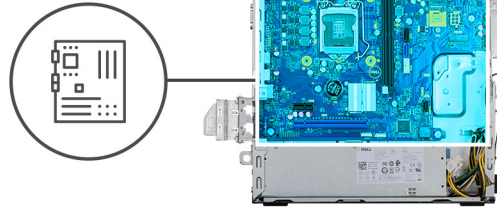
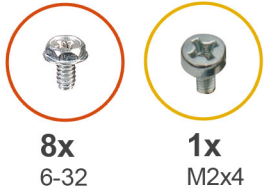



9



Steps

1. Lay the computer on the right side.
2. Remove the screw (#6-32) that secures the front I/O-bracket to the chassis and remove the front I/O-bracket.
3. Disconnect the 4-pin power supply ATEX connector from the system board.
4. Disconnect the 6-pin power supply ATEX connector from the system board.
5. Disconnect the front I/O cable connector from the system board.
6. Disconnect the SATA cables from the system board.
7. Disconnect the power switch cable from the system board.
8. Remove the eight (#6-32) screws that secure the system board to the chassis.
9. Remove the screw (M2x4) that secures the system board to the chassis.
10. Lift the system board at an angle and remove the system board off the chassis.

Installing the system board

Prerequisites

If you are replacing a component, remove the existing component before performing the installation procedure.

About this task

The following images indicate the location of the system board and provides a visual representation of the installation procedure:

1



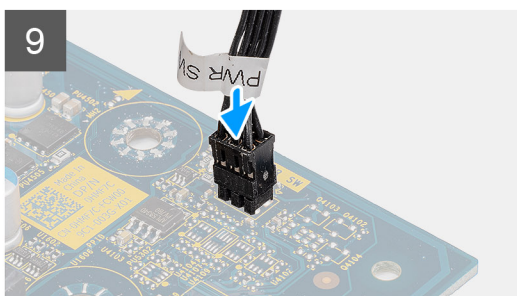
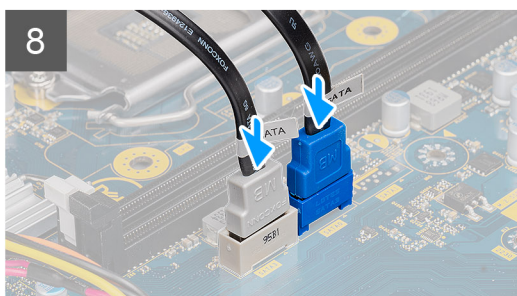
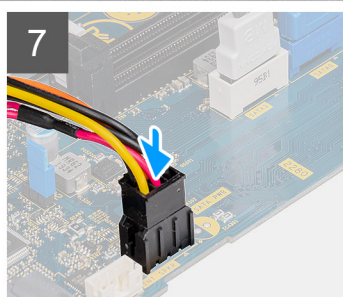
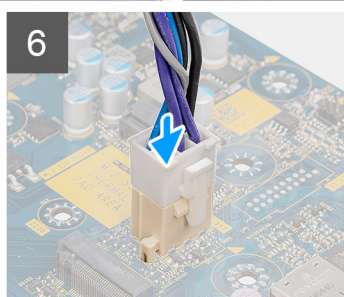
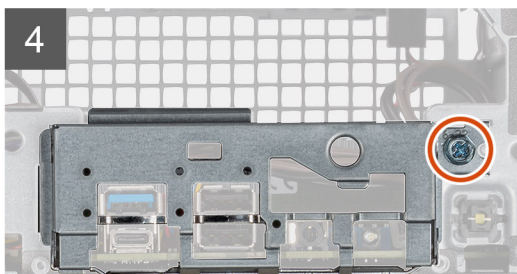
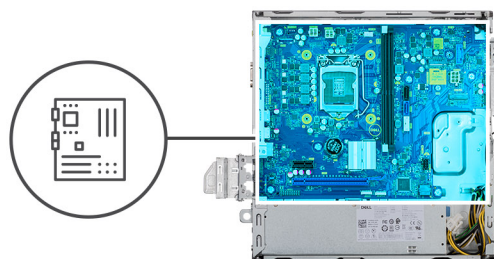



Steps

1. Slide the front I/O-ports on the system board into the front I/O-slots on the chassis and align the screw holes on the system board with the screw holes on the chassis.
2. Align the front I/O-bracket with the slots on the chassis.
3. Lay the system unit vertically and secure it using the eight #6-32 screws to the chassis.
4. Replace the screw (M2x4) that secures the system board to the chassis.
5. Connect the 4-pin power supply ATEX connector to the system board.
6. Connect the 6-pin power supply ATEX connector to the system board.
7. Connect the front I/O cable connector to the system board.
8. Connect the SATA cables to the system board.
9. Connect the power switch cable to the system board.

Next steps

1. Install the [processor](#).
2. Install the [heat sink](#).
3. Install the [media card reader](#)
4. Install the [WLAN card](#)
5. Install the [solid-state drive/Intel Optane memory module](#).
6. Install the [graphics card](#).

7. Install the [memory modules](#).
8. Install the [HDD/ODD Bracket](#).
9. Install the [front bezel](#).
10. Install the [side cover](#).
11. Follow the procedure in [After working inside your computer](#).
 -  **NOTE:** Your computer's Service Tag is stored in the system board. You must enter the Service Tag in the BIOS setup program after you replace the system board.
 -  **NOTE:** Replacing the system board removes any changes that you have made to the BIOS using the BIOS setup program. You must make the appropriate changes again after you replace the system board.

System setup

System setup enables you to manage your hardware and specify BIOS level options. From the System setup, you can:

- Change the NVRAM settings after you add or remove hardware
- View the system hardware configuration
- Enable or disable integrated devices
- Set performance and power management thresholds
- Manage your computer security

BIOS overview

The BIOS manages data flow between the computer's operating system and attached devices such as hard disk, video adapter, keyboard, mouse, and printer.

Entering BIOS setup program

About this task

Turn on (or restart) your computer and press F2 immediately.

Boot menu

Press <F12> when the Dell logo appears to initiate a one-time boot menu with a list of the valid boot devices for the system. Diagnostics and BIOS Setup options are also included in this menu. The devices listed on the boot menu depend on the bootable devices in the system. This menu is useful when you are attempting to boot to a particular device or to bring up the diagnostics for the system. Using the boot menu does not make any changes to the boot order stored in the BIOS.

The options are:

- UEFI Boot:
 - Windows Boot Manager
- Other Options:
 - BIOS Setup
 - BIOS Flash Update
 - Diagnostics
 - Change Boot Mode Settings

Navigation keys

 **NOTE:** For most of the System Setup options, changes that you make are recorded but do not take effect until you restart the system.

Keys	Navigation
Up arrow	Moves to the previous field.
Down arrow	Moves to the next field.
Enter	Selects a value in the selected field (if applicable) or follow the link in the field.
Spacebar	Expands or collapses a drop-down list, if applicable.

Keys	Navigation
Tab	Moves to the next focus area.
Esc	Moves to the previous page until you view the main screen. Pressing Esc in the main screen displays a message that prompts you to save any unsaved changes and restarts the system.

Boot Sequence

Boot Sequence allows you to bypass the System Setup–defined boot device order and boot directly to a specific device (for example: optical drive or hard drive). During the Power-on Self Test (POST), when the Dell logo appears, you can:

- Access System Setup by pressing F2 key
- Bring up the one-time boot menu by pressing F12 key

The one-time boot menu displays the devices that you can boot from including the diagnostic option. The boot menu options are:

- Removable Drive (if available)
- STXXXX Drive (if available)
 - **i** **NOTE:** XXX denotes the SATA drive number.
- Optical Drive (if available)
- SATA Hard Drive (if available)
- Diagnostics
 - **i** **NOTE:** Choosing **Diagnostics**, will display the **diagnostics** screen.

The boot sequence screen also displays the option to access the System Setup screen.

System setup options

i **NOTE:** Depending on this computer and its installed devices, the items listed in this section may or may not appear.

Table 4. System setup options—System information menu

General-System Information	
System Information	
BIOS Version	Displays the BIOS version number.
Service Tag	Displays the Service Tag of the computer.
Asset Tag	Displays the Asset Tag of the computer.
Ownership Tag	Displays the ownership tag of the computer.
Manufacture Date	Displays the manufacture date of the computer.
Ownership Date	Displays the ownership date of the computer.
Express Service Code	Displays the express service code of the computer.
Memory Information	
Memory Installed	Displays the total computer memory installed.
Memory Available	Displays the total computer memory available.
Memory Speed	Displays the memory speed.
Memory Channel Mode	Displays single or dual channel mode.
Memory Technology	Displays the technology used for the memory.
DIMM 1 Size	Displays the DIMM 1 memory size.
DIMM 2 Size	Displays the DIMM 2 memory size.

Table 4. System setup options—System information menu (continued)

General-System Information	
PCI Information	
SLOT2	Displays the PCI information of the computer.
SLOT3	Displays the PCI information of the computer.
SLOT5_M.2	Displays the PCI information of the computer.
Processor Information	
Processor Type	Displays the processor type.
Core Count	Displays the number of cores on the processor.
Processor ID	Displays the processor identification code.
Current Clock Speed	Displays the current processor clock speed.
Minimum Clock Speed	Displays the minimum processor clock speed.
Maximum Clock Speed	Displays the maximum processor clock speed.
Processor L2 Cache	Displays the Processor L2 Cache size.
Processor L3 Cache	Displays the Processor L2 Cache size.
HT Capable	Displays whether the processor is HyperThreading (HT) capable.
64-Bit Technology	Displays whether 64-bit technology is used.
Device Information	
SATA-0	Displays the SATA device information of the computer.
SATA-1	Displays the SATA device information of the computer.
M.2 PCIe SSD-2	Displays the M.2 PCIe SSD information of the computer.
LOM MAC Address	Displays the LOM MAC address of the computer.
Video Controller	Displays the video controller type of the computer.
Audio Controller	Displays the audio controller information of the computer.
Wi-Fi Device	Displays the wireless device information of the computer.
Bluetooth Device	Displays the bluetooth device information of the computer.
Boot Sequence	
Boot Sequence	Displays the boot sequence.
Boot List Option	Displays the available boot options.
UEFI Boot Path Security	
Always,Except Internal HDD	Enable or disable the system to prompt the user to enter the Admin password when booting a UEFI boot path from the F12 boot menu. Default: Enabled
Always	Enable or disable the system to prompt the user to enter the Admin password when booting a UEFI boot path from the F12 boot menu. Default: Disabled
Never	Enable or disable the system to prompt the user to enter the Admin password when booting a UEFI boot path from the F12 boot menu. Default: Disabled
Date/Time	Displays the current date in MM/DD/YY format and current time in HH:MM:SS AM/PM format.

Table 5. System setup options—System Configuration menu

System Configuration	
Integrated NIC	
Enable UEFI Network Stack	Controls the on-board LAN controller. Enable or disable UEFI Network Stack.

Table 5. System setup options—System Configuration menu (continued)

System Configuration	
SATA Operation	Configure operating mode of the integrated SATA hard drive controller.
Drives	Enable or disable various drives on board.
SATA-0	Displays the SATA device information of the computer.
SATA-1	Displays the SATA device information of the computer.
M.2 PCIe SSD-2	Displays the M.2 PCIe SSD information of the computer.
SMART Reporting	Enable or disable SMART Reporting during system startup.
USB Configuration	
Enable USB Boot Support	Enable or disable booting from USB mass storage devices such as external hard drive, optical drive, and USB drive.
Enable front USB Port	Enable or disable the front USB ports.
Enable rear USB Port	Enable or disable the rear USB ports.
Front USB Configuration	Enable or disable the front USB ports.
Rear USB Configuration	Enable or disable the rear USB ports.
Audio	Enable or disable the integrated audio controller.
Miscellaneous Devices	Enable or disable various onboard devices.

Table 6. System setup options—Video menu

Video	
Multi-Display	Enable or disable multiple displays.
Primary Display	Set or change the primary display.

Table 7. System setup options—Security menu

Security	
Admin Password	Set, change, or delete the administrator password.
System Password	Set, change, or delete the system password.
Internal HDD-0 Password	Set, change, or delete the internal hard-disk drive password.
Password Configuration	Control the minimum and maximum number of characters allowed for Admin and System passwords.
Password Change	Enable or disable changes to the System and Hard Disk passwords when an administrator password is set.
UEFI Capsule Firmware Updates	Enable or disable BIOS updates through UEFI capsule update packages.
PTT Security	
PTT On	Enable or disable Platform Trust Technology (PTT) visibility to the operating system.
Clear	Default: Disabled
PPI ByPass for Clear Command	Enable or disable the TPM Physical Presence Interface (PPI). When enabled, this setting will allow the OS to skip BIOS PPI user prompts when issuing the Clear command. Changes to this setting take effect immediately. Default: Disabled
Absolute(R)	Enable or disable the BIOS module interface of the optional Computrace(R) Service from Absolute Software.
Admin Setup Lockout	Enable to prevent users from entering Setup when an Admin Password is set.
Master Password Lockout	Disables the master password support. Hard Disk passwords need to be cleared before changing the setting.

Table 7. System setup options—Security menu (continued)

Security	
SMM Security Mitigation	Enable or disable SMM Security Mitigation

Table 8. System setup options—Secure Boot menu

Secure Boot	
Secure Boot Enable	Enable or disable the secure boot feature.
Secure Boot Mode	Modifies the behavior of Secure Boot to allow evaluation or enforcement of UEFI driver signatures. <ul style="list-style-type: none"> • Deployed Mode-Default: Enabled • Audit Mode-Default: Disabled
Deployed Mode	Enable or disable the deployed mode.
Audit Mode	Enable or disable the audit mode.
Expert Key Management	
Expert Key Management	Enable or disable Expert Key Management.
Custom Mode Key Management	Select the custom values for expert key management.

Table 9. System setup options—Intel Software Guard Extensions menu

Intel Software Guard Extensions	
Intel SGX Enable	Enable or disable Intel Software Guard Extensions.
Enclave Memory Size	Set the Intel Software Guard Extensions Enclave Reserve Memory Size.
Performance	
Multi Core Support	Enable multiple cores. Default: Enabled.
Intel SpeedStep	Enable or disable Intel Speedstep Technology. Default: Enabled. i NOTE: If enabled, the processor clock speed and core voltage are adjusted dynamically based on the processor load.
C-States Control	Enable or disable additional processor sleep states. Default: Enabled.
Intel TurboBoost	Enable or disable Intel TurboBoost mode of the processor. Default: Enabled.
HyperThread control	Enable or disable HyperThreading in the processor. Default: Enabled.
Power Management	
AC Recovery	Sets what action the computer takes when power is restored.
Enable Intel Speed Shift Technology	Enable or disable Intel Speed Shift Technology.
Auto On Time	Enable to set the computer to turn on automatically every day or on a preselected date and time. This option can be configured only if the Auto On Time is set to Everyday, Weekdays or Selected Days. Default: Disabled.
USB Wake Support	Enable the USB devices to wake the computer from Standby.
Deep Sleep Control	Enables you to control the Deep Sleep mode support.

Table 9. System setup options—Intel Software Guard Extensions menu (continued)

Intel Software Guard Extensions	
Wake on LAN/WLAN	Enables the computer to be powered on by special LAN signals.
Block sleep	Enables you to block entering to sleep mode in OS environment.
POST Behavior	
Numlock LED	Enables the NumLock function when computer boots.
Keyboard Errors	Enables the keyboard error detection.
Fastboot	Enable to set the speed of the boot process. Default: Thorough.
Extend BIOS POST Time	Configure additional pre-boot delay.
Full Screen Logo	Enable or disable to display full screen logo.
Warnings and Errors	Sets the boot process to pause when Warnings or Errors are detected.

Table 10. System setup options—Virtualization Support menu

Virtualization Support	
Virtualization	Specify whether a Virtual Machine Monitor (VMM) can utilize the additional hardware capabilities provided by Intel Virtualization Technology.
VT for Direct I/O	Specify whether a Virtual Machine Monitor (VMM) can utilize the additional hardware capabilities provided by Intel Virtualization Technology for Direct I/O.

Table 11. System setup options—Wireless menu

Wireless	
Wireless Device Enable	Enable or disable internal wireless devices.

Table 12. System setup options—Maintenance menu

Maintenance	
Service Tag	Display the system's Service Tag.
Asset Tag	Create a system Asset Tag.
SERR Messages	Enable or disable SERR messages.
BIOS Downgrade	Control flashing of the system firmware to previous revisions.
Data Wipe	Enable to securely erase data from all internal storage devices.
BIOS Recovery	Enable the user to recover from certain corrupted BIOS conditions from a recovery file on the user primary hard drive or an external USB key.

Table 13. System setup options—System Logs menu

System Logs	
BIOS Events	Display BIOS events.

Table 14. System setup options—SupportAssist System Resolution menu

SupportAssist System Resolution	
Auto OS Recovery Threshold	Control the automatic boot flow for SupportAssist System Resolution Console and for Dell OS Recovery tool.

Updating the BIOS

Updating the BIOS in Windows

About this task

 **CAUTION:** If BitLocker is not suspended before updating the BIOS, the next time you reboot the system it will not recognize the BitLocker key. You will then be prompted to enter the recovery key to progress and the system will ask for this on each reboot. If the recovery key is not known this can result in data loss or an unnecessary operating system re-install. For more information on this subject, see Knowledge Article: <https://www.dell.com/support/article/sln153694>

Steps

1. Go to www.dell.com/support.
2. Click **Product support**. In the **Search support** box, enter the Service Tag of your computer, and then click **Search**.
 **NOTE:** If you do not have the Service Tag, use the SupportAssist feature to automatically identify your computer. You can also use the product ID or manually browse for your computer model.
3. Click **Drivers & Downloads**. Expand **Find drivers**.
4. Select the operating system installed on your computer.
5. In the **Category** drop-down list, select **BIOS**.
6. Select the latest version of BIOS, and click **Download** to download the BIOS file for your computer.
7. After the download is complete, browse the folder where you saved the BIOS update file.
8. Double-click the BIOS update file icon and follow the on-screen instructions.
For more information, see knowledge base article [000124211](https://www.dell.com/support/article/000124211) at www.dell.com/support.

Updating the BIOS in Linux and Ubuntu

To update the system BIOS on a computer that is installed with Linux or Ubuntu, see the knowledge base article [000131486](https://www.dell.com/support/article/000131486) at www.dell.com/support.

Updating the BIOS using the USB drive in Windows

About this task

 **CAUTION:** If BitLocker is not suspended before updating the BIOS, the next time you reboot the system it will not recognize the BitLocker key. You will then be prompted to enter the recovery key to progress and the system will ask for this on each reboot. If the recovery key is not known this can result in data loss or an unnecessary operating system re-install. For more information on this subject, see Knowledge Article: <https://www.dell.com/support/article/sln153694>

Steps

1. Follow the procedure from step 1 to step 6 in [Updating the BIOS in Windows](#) to download the latest BIOS setup program file.
2. Create a bootable USB drive. For more information, see the knowledge base article [000145519](https://www.dell.com/support/article/000145519) at www.dell.com/support.
3. Copy the BIOS setup program file to the bootable USB drive.
4. Connect the bootable USB drive to the computer that needs the BIOS update.
5. Restart the computer and press **F12**.
6. Select the USB drive from the **One Time Boot Menu**.
7. Type the BIOS setup program filename and press **Enter**.
The **BIOS Update Utility** appears.
8. Follow the on-screen instructions to complete the BIOS update.

Updating the BIOS from the F12 One-Time boot menu

Update your computer BIOS using the BIOS update.exe file that is copied to a FAT32 USB drive and booting from the F12 One-Time boot menu.

About this task

CAUTION: If BitLocker is not suspended before updating the BIOS, the next time you reboot the system it will not recognize the BitLocker key. You will then be prompted to enter the recovery key to progress and the system will ask for this on each reboot. If the recovery key is not known this can result in data loss or an unnecessary operating system re-install. For more information on this subject, see Knowledge Article: <https://www.dell.com/support/article/sln153694>

BIOS Update

You can run the BIOS update file from Windows using a bootable USB drive or you can also update the BIOS from the F12 One-Time boot menu on the computer.

Most of the Dell computers built after 2012 have this capability, and you can confirm by booting your computer to the F12 One-Time Boot Menu to see if BIOS FLASH UPDATE is listed as a boot option for your computer. If the option is listed, then the BIOS supports this BIOS update option.

NOTE: Only computers with BIOS Flash Update option in the F12 One-Time boot menu can use this function.

Updating from the One-Time boot menu

To update your BIOS from the F12 One-Time boot menu, you need the following:

- USB drive formatted to the FAT32 file system (key does not have to be bootable)
- BIOS executable file that you downloaded from the Dell Support website and copied to the root of the USB drive
- AC power adapter that is connected to the computer
- Functional computer battery to flash the BIOS

Perform the following steps to perform the BIOS update flash process from the F12 menu:

CAUTION: Do not turn off the computer during the BIOS update process. The computer may not boot if you turn off your computer.

Steps

1. From a turn off state, insert the USB drive where you copied the flash into a USB port of the computer.
2. Turn on the computer and press F12 to access the One-Time Boot Menu, select BIOS Update using the mouse or arrow keys then press Enter.
The flash BIOS menu is displayed.
3. Click **Flash from file**.
4. Select external USB device.
5. Select the file and double-click the flash target file, and then click **Submit**.
6. Click **Update BIOS**. The computer restarts to flash the BIOS.
7. The computer will restart after the BIOS update is completed.

System and setup password

Table 15. System and setup password

Password type	Description
System password	Password that you must enter to log in to your system.
Setup password	Password that you must enter to access and make changes to the BIOS settings of your computer.

You can create a system password and a setup password to secure your computer.

 **CAUTION:** The password features provide a basic level of security for the data on your computer.

 **CAUTION:** Anyone can access the data that is stored on your computer if it is not locked and left unattended.

 **NOTE:** System and setup password feature is disabled.

Assigning a system setup password

Prerequisites

You can assign a new **System or Admin Password** only when the status is in **Not Set**.

About this task

To enter the system setup, press F12 immediately after a power-on or reboot.

Steps

1. In the **System BIOS** or **System Setup** screen, select **Security** and press Enter.
The **Security** screen is displayed.
2. Select **System/Admin Password** and create a password in the **Enter the new password** field.
Use the following guidelines to assign the system password:
 - A password can have up to 32 characters.
 - The password can contain the numbers 0 through 9.
 - Only lower case letters are valid, upper case letters are not valid.
 - Only the following special characters are valid: Space, ("), (+), (.), (-), (.), (/), (:), ([), (\), (]), (`).
3. Type the system password that you entered earlier in the **Confirm new password** field and click **OK**.
4. Press Esc and a message prompts you to save the changes.
5. Press Y to save the changes.
The computer restarts.

Deleting or changing an existing system setup password

Prerequisites

Ensure that the **Password Status** is Unlocked (in the System Setup) before attempting to delete or change the existing System and/or Setup password. You cannot delete or change an existing System or Setup password, if the **Password Status** is Locked.

About this task

To enter the System Setup, press F12 immediately after a power-on or reboot.

Steps

1. In the **System BIOS** or **System Setup** screen, select **System Security** and press Enter.
The **System Security** screen is displayed.
2. In the **System Security** screen, verify that **Password Status** is **Unlocked**.
3. Select **System Password**, update, or delete the existing system password, and press Enter or Tab.
4. Select **Setup Password**, update, or delete the existing setup password, and press Enter or Tab.
 **NOTE:** If you change the System and/or Setup password, reenter the new password when prompted. If you delete the System and/or Setup password, confirm the deletion when prompted.
5. Press Esc and a message prompts you to save the changes.
6. Press Y to save the changes and exit from System Setup.
The computer restarts.

Clearing CMOS settings/RTC reset

About this task

 **CAUTION:** Clearing CMOS settings will reset the BIOS settings on your computer as well as reset the Real-Time Clock on your BIOS.

Steps

1. Press and hold the power button for 30 seconds.
2. Release the power button and allow the system to boot.

Clearing BIOS (System Setup) and System passwords

About this task

 **NOTE:** To conduct a BIOS and System password reset, you must call the Dell Tech Support number in your region.

Steps

1. Key in your computer's service tag number into the locked BIOS/system setup screen.
2. Convey the code generated to the Dell Tech Support agent.
3. The Dell Tech Support agent will provide a 32 character Master System Password that can be used to access the locked BIO/system setup.

Troubleshooting

Dell SupportAssist Pre-boot System Performance Check diagnostics

About this task

SupportAssist diagnostics (also known as system diagnostics) performs a complete check of your hardware. The Dell SupportAssist Pre-boot System Performance Check diagnostics is embedded with the BIOS and is launched by the BIOS internally. The embedded system diagnostics provides a set of options for particular devices or device groups allowing you to:

- Run tests automatically or in an interactive mode
- Repeat tests
- Display or save test results
- Run thorough tests to introduce additional test options to provide extra information about the failed device(s)
- View status messages that inform you if tests are completed successfully
- View error messages that inform you of problems encountered during testing

 **NOTE:** Some tests for specific devices require user interaction. Always ensure that you are present at the computer terminal when the diagnostic tests are performed.

For more information, see <https://www.dell.com/support/kbdoc/000180971>.

Running the SupportAssist Pre-Boot System Performance Check

Steps

1. Turn on your computer.
2. As the computer boots, press the F12 key as the Dell logo appears.
3. On the boot menu screen, select the **Diagnostics** option.
4. Click the arrow at the bottom left corner.
Diagnostics front page is displayed.
5. Click the arrow in the lower-right corner to go to the page listing.
The items detected are listed.
6. To run a diagnostic test on a specific device, press Esc and click **Yes** to stop the diagnostic test.
7. Select the device from the left pane and click **Run Tests**.
8. If there are any issues, error codes are displayed.
Note the error code and validation number and contact Dell.

Real-Time Clock (RTC Reset)

The Real Time Clock (RTC) reset function allows you or the service technician to recover Dell Inspiron, systems from No POST/No Power/No Boot situations. The legacy jumper enabled RTC reset has been retired on these models.

Start the RTC reset with the system powered off and connected to AC power. Press and hold the power button for thirty (30) seconds. The system RTC Reset occurs after you release the power button.

System diagnostic lights

Power-supply diagnostics light

Indicates the status of the power-supply in either of the two states:

- Off: No Power
- On: Power is supplied.

Power button light

Table 16. Power button LED status

Power button LED state	System state	Description
Off	<ul style="list-style-type: none"> • S4 • S5 	There is in Hibernate or Off state.
Solid White	S0	Working state
Solid Amber		Various sleep states or No POST
Blinking Amber/White		Failure to POST

This platform relies on the Power button LED light blinking in an amber/white pattern to determine a failure as listed in the following table:

NOTE:

The blinking patterns consists of two numbers (representing First Group: Amber blinks, Second Group: White blinks).

- **First Group:** The Power button LED light blinks Amber, 1 to 9 times followed by a short pause with LED off for a couple of seconds.
- **Second Group:** The Power button LED light then blinks White, 1 to 9 times, followed by a longer pause before the next cycle starts again after a short interval.

Example: No Memory detected (2,3). Power button LED blinks 2-times in Amber followed by a pause, and then blinks 3-times in White. The Power button LED will pause for few seconds before the next cycle repeats itself again.

Table 17. Diagnostics LED codes

Diagnostic light codes	Problem description
1,2	Unrecoverable SPI flash failure
2,1	CPU failure
2,2	System board failure, corrupt BIOS, ROM error
2,3	No memory/RAM detected
2,4	Memory/RAM failure
2,5	Invalid Memory installed
2,6	System board error, chipset error, clock failure, gate A20 failure, super I/O failure, keyboard controller failure
3,1	CMOS battery failure
3,2	PCIe or video card/chip failure
3,3	Recovery Image not found
3,4	Recovery Image found but invalid
3,5	Power Rail Failure
3,6	Paid SPI volume error
3,7	Intel (ME) Management Engine error

Table 17. Diagnostics LED codes (continued)

Diagnostic light codes	Problem description
4,2	CPU power cable connection issue

Diagnostic error messages

Table 18. Diagnostic error messages

Error messages	Description
AUXILIARY DEVICE FAILURE	The touchpad or external mouse may be faulty. For an external mouse, check the cable connection. Enable the Pointing Device option in the System Setup program.
BAD COMMAND OR FILE NAME	Ensure that you have spelled the command correctly, put spaces in the proper place, and used the correct path name.
CACHE DISABLED DUE TO FAILURE	The primary cache internal to the microprocessor has failed. Contact Dell
CD DRIVE CONTROLLER FAILURE	The optical drive does not respond to commands from the computer.
DATA ERROR	The hard drive cannot read the data.
DECREASING AVAILABLE MEMORY	One or more memory modules may be faulty or improperly seated. Reinstall the memory modules or, if necessary, replace them.
DISK C: FAILED INITIALIZATION	The hard drive failed initialization. Run the hard drive tests in Dell Diagnostics .
DRIVE NOT READY	The operation requires a hard drive in the bay before it can continue. Install a hard drive in the hard drive bay.
ERROR READING PCMCIA CARD	The computer cannot identify the ExpressCard. Reinsert the card or try another card.
EXTENDED MEMORY SIZE HAS CHANGED	The amount of memory recorded in non-volatile memory (NVRAM) does not match the memory module installed in the computer. Restart the computer. If the error appears again, Contact Dell
THE FILE BEING COPIED IS TOO LARGE FOR THE DESTINATION DRIVE	The file that you are trying to copy is too large to fit on the disk, or the disk is full. Try copying the file to a different disk or use a larger capacity disk.
A FILENAME CANNOT CONTAIN ANY OF THE FOLLOWING CHARACTERS: \ / : * ? " < > -	Do not use these characters in filenames.
GATE A20 FAILURE	A memory module may be loose. Reinstall the memory module or, if necessary, replace it.
GENERAL FAILURE	The operating system is unable to carry out the command. The message is usually followed by specific information. For example, <i>Printer out of paper</i> . Take the appropriate action.
HARD-DISK DRIVE CONFIGURATION ERROR	The computer cannot identify the drive type. Shut down the computer, remove the hard drive, and boot the computer from an optical drive. Then, shut down the computer, reinstall the hard drive, and restart the computer. Run the Hard Disk Drive tests in Dell Diagnostics .
HARD-DISK DRIVE CONTROLLER FAILURE 0	The hard drive does not respond to commands from the computer. Shut down the computer, remove the hard drive, and boot the computer from an optical drive. Then, shut

Table 18. Diagnostic error messages (continued)

Error messages	Description
	down the computer, reinstall the hard drive, and restart the computer. If the problem persists, try another drive. Run the Hard Disk Drive tests in Dell Diagnostics .
HARD-DISK DRIVE FAILURE	The hard drive does not respond to commands from the computer. Shut down the computer, remove the hard drive, and boot the computer from an optical drive. Then, shut down the computer, reinstall the hard drive, and restart the computer. If the problem persists, try another drive. Run the Hard Disk Drive tests in Dell Diagnostics .
HARD-DISK DRIVE READ FAILURE	The hard drive may be defective. Shut down the computer, remove the hard drive, and boot the computer from an optical. Then, shut down the computer, reinstall the hard drive, and restart the computer. If the problem persists, try another drive. Run the Hard Disk Drive tests in Dell Diagnostics .
INSERT BOOTABLE MEDIA	The operating system is trying to boot to non-bootable media, such as an optical drive. Insert bootable media.
INVALID CONFIGURATION INFORMATION-PLEASE RUN SYSTEM SETUP PROGRAM	The system configuration information does not match the hardware configuration. The message is most likely to occur after a memory module is installed. Correct the appropriate options in the system setup program.
KEYBOARD CLOCK LINE FAILURE	For external keyboards, check the cable connection. Run the Keyboard Controller test in Dell Diagnostics .
KEYBOARD CONTROLLER FAILURE	For external keyboards, check the cable connection. Restart the computer, and avoid touching the keyboard or the mouse during the boot routine. Run the Keyboard Controller test in Dell Diagnostics .
KEYBOARD DATA LINE FAILURE	For external keyboards, check the cable connection. Run the Keyboard Controller test in Dell Diagnostics .
KEYBOARD STUCK KEY FAILURE	For external keyboards or keypads, check the cable connection. Restart the computer, and avoid touching the keyboard or keys during the boot routine. Run the Stuck Key test in Dell Diagnostics .
LICENSED CONTENT IS NOT ACCESSIBLE IN MEDIADIRECT	Dell MediaDirect cannot verify the Digital Rights Management (DRM) restrictions on the file, so the file cannot be played.
MEMORY ADDRESS LINE FAILURE AT ADDRESS, READ VALUE EXPECTING VALUE	A memory module may be faulty or improperly seated. Reinstall the memory module or, if necessary, replace it.
MEMORY ALLOCATION ERROR	The software you are attempting to run is conflicting with the operating system, another program, or a utility. Shut down the computer, wait for 30 seconds, and then restart it. Run the program again. If the error message still appears, see the software documentation.
MEMORY DOUBLE WORD LOGIC FAILURE AT ADDRESS, READ VALUE EXPECTING VALUE	A memory module may be faulty or improperly seated. Reinstall the memory module or, if necessary, replace it.
MEMORY ODD/EVEN LOGIC FAILURE AT ADDRESS, READ VALUE EXPECTING VALUE	A memory module may be faulty or improperly seated. Reinstall the memory module or, if necessary, replace it.
MEMORY WRITE/READ FAILURE AT ADDRESS, READ VALUE EXPECTING VALUE	A memory module may be faulty or improperly seated. Reinstall the memory module or, if necessary, replace it.
NO BOOT DEVICE AVAILABLE	The computer cannot find the hard drive. If the hard drive is your boot device, ensure that the drive is installed, properly seated, and partitioned as a boot device.

Table 18. Diagnostic error messages (continued)

Error messages	Description
NO BOOT SECTOR ON HARD DRIVE	The operating system may be corrupted, Contact Dell.
NO TIMER TICK INTERRUPT	A chip on the system board may be malfunctioning. Run the System Set tests in Dell Diagnostics.
NOT ENOUGH MEMORY OR RESOURCES. EXIT SOME PROGRAMS AND TRY AGAIN	You have too many programs open. Close all windows and open the program that you want to use.
OPERATING SYSTEM NOT FOUND	Reinstall the operating system. If the problem persists, Contact Dell.
OPTIONAL ROM BAD CHECKSUM	The optional ROM has failed. Contact Dell.
SECTOR NOT FOUND	The operating system cannot locate a sector on the hard drive. You may have a defective sector or corrupted File Allocation Table (FAT) on the hard drive. Run the Windows error-checking utility to check the file structure on the hard drive. See Windows Help and Support for instructions (click Start > Help and Support). If a large number of sectors are defective, back up the data (if possible), and then format the hard drive.
SEEK ERROR	The operating system cannot find a specific track on the hard drive.
SHUTDOWN FAILURE	A chip on the system board may be malfunctioning. Run the System Set tests in Dell Diagnostics. If the message reappears, Contact Dell.
TIME-OF-DAY CLOCK LOST POWER	System configuration settings are corrupted. Connect your computer to an electrical outlet to charge the battery. If the problem persists, try to restore the data by entering the System Setup program, then immediately exit the program. If the message reappears, Contact Dell.
TIME-OF-DAY CLOCK STOPPED	The reserve battery that supports the system configuration settings may require recharging. Connect your computer to an electrical outlet to charge the battery. If the problem persists, Contact Dell.
TIME-OF-DAY NOT SET-PLEASE RUN THE SYSTEM SETUP PROGRAM	The time or date stored in the system setup program does not match the system clock. Correct the settings for the Date and Time options.
TIMER CHIP COUNTER 2 FAILED	A chip on the system board may be malfunctioning. Run the System Set tests in Dell Diagnostics.
UNEXPECTED INTERRUPT IN PROTECTED MODE	The keyboard controller may be malfunctioning, or a memory module may be loose. Run the System Memory tests and the Keyboard Controller test in Dell Diagnostics or Contact Dell.
X:\ IS NOT ACCESSIBLE. THE DEVICE IS NOT READY	Insert a disk into the drive and try again.

System error messages

Table 19. System error messages

System message	Description
Alert! Previous attempts at booting this system have failed at checkpoint [nnnn]. For help in resolving this problem, please note	The computer failed to complete the boot routine three consecutive times for the same error.

Table 19. System error messages (continued)

System message	Description
this checkpoint and contact Dell Technical Support	
CMOS checksum error	RTC is reset, BIOS Setup default has been loaded.
CPU fan failure	CPU fan has failed.
System fan failure	System fan has failed.
Hard-disk drive failure	Possible hard disk drive failure during POST.
Keyboard failure	Keyboard failure or loose cable. If reseating the cable does not solve the problem, replace the keyboard.
No boot device available	No bootable partition on hard disk drive, the hard disk drive cable is loose, or no bootable device exists. <ul style="list-style-type: none">• If the hard drive is your boot device, ensure that the cables are connected and that the drive is installed properly and partitioned as a boot device.• Enter system setup and ensure that the boot sequence information is correct.
No timer tick interrupt	A chip on the system board might be malfunctioning or motherboard failure.
NOTICE - Hard Drive SELF MONITORING SYSTEM has reported that a parameter has exceeded its normal operating range. Dell recommends that you back up your data regularly. A parameter out of range may or may not indicate a potential hard drive problem	S.M.A.R.T error, possible hard disk drive failure.

Recovering the operating system

When your computer is unable to boot to the operating system even after repeated attempts, it automatically starts Dell SupportAssist OS Recovery.

Dell SupportAssist OS Recovery is a standalone tool that is preinstalled in all Dell computers installed with Windows operating system. It consists of tools to diagnose and troubleshoot issues that may occur before your computer boots to the operating system. It enables you to diagnose hardware issues, repair your computer, back up your files, or restore your computer to its factory state.

You can also download it from the Dell Support website to troubleshoot and fix your computer when it fails to boot into their primary operating system due to software or hardware failures.

For more information about the Dell SupportAssist OS Recovery, see *Dell SupportAssist OS Recovery User's Guide* at www.dell.com/serviceabilitytools. Click **SupportAssist** and then, click **SupportAssist OS Recovery**.

Updating the BIOS using the USB drive in Windows

Steps

1. Follow the procedure from step 1 to step 6 in [Updating the BIOS in Windows](#) to download the latest BIOS setup program file.
2. Create a bootable USB drive. For more information, see the knowledge base article [000145519](http://www.dell.com/support) at www.dell.com/support.
3. Copy the BIOS setup program file to the bootable USB drive.
4. Connect the bootable USB drive to the computer that needs the BIOS update.
5. Restart the computer and press **F12**.
6. Select the USB drive from the **One Time Boot Menu**.
7. Type the BIOS setup program filename and press **Enter**.
The **BIOS Update Utility** appears.

8. Follow the on-screen instructions to complete the BIOS update.

Updating the BIOS in Windows

Steps

1. Go to www.dell.com/support.
2. Click **Product support**. In the **Search support** box, enter the Service Tag of your computer, and then click **Search**.
 **NOTE:** If you do not have the Service Tag, use the SupportAssist feature to automatically identify your computer. You can also use the product ID or manually browse for your computer model.
3. Click **Drivers & Downloads**. Expand **Find drivers**.
4. Select the operating system installed on your computer.
5. In the **Category** drop-down list, select **BIOS**.
6. Select the latest version of BIOS, and click **Download** to download the BIOS file for your computer.
7. After the download is complete, browse the folder where you saved the BIOS update file.
8. Double-click the BIOS update file icon and follow the on-screen instructions.
For more information, see knowledge base article [000124211](https://www.dell.com/support/000124211) at www.dell.com/support.

Backup media and recovery options

It is recommended to create a recovery drive to troubleshoot and fix problems that may occur with Windows. Dell proposes multiple options for recovering Windows operating system on your Dell PC. For more information, see [Dell Windows Backup Media and Recovery Options](#).

WiFi power cycle

About this task

If your computer is unable to access the internet due to WiFi connectivity issues a WiFi power cycle procedure may be performed. The following procedure provides the instructions on how to conduct a WiFi power cycle:

 **NOTE:** Some ISPs (Internet Service Providers) provide a modem/router combo device.

Steps

1. Turn off your computer.
2. Turn off the modem.
3. Turn off the wireless router.
4. Wait for 30 seconds.
5. Turn on the wireless router.
6. Turn on the modem.
7. Turn on your computer.

Drain residual flea power (perform hard reset)

About this task

Flea power is the residual static electricity that remains in the computer even after it has been powered off and the battery is removed.

For your safety, and to protect the sensitive electronic components in your computer, you are requested to drain residual flea power before removing or replacing any components in your computer.

Draining residual flea power, also known as performing a "hard reset", is also a common troubleshooting step if your computer does not power on or boot into the operating system.

To drain residual flea power (perform a hard reset)

Steps

1. Turn off your computer.
2. Disconnect the power adapter from your computer.
3. Remove the base cover.
4. Remove the battery.
5. Press and hold the power button for 20 seconds to drain the flea power.
6. Install the battery.
7. Install the base cover.
8. Connect the power adapter to your computer.
9. Turn on your computer.



 **NOTE:** For more information about performing a hard reset, see the knowledge base article [000130881](https://www.dell.com/support) at www.dell.com/support.

Getting help and contacting Dell

Self-help resources

You can get information and help on Dell products and services using these self-help resources:

Table 20. Self-help resources

Self-help resources	Resource location
Information about Dell products and services	www.dell.com
My Dell app	
Tips	
Contact Support	In Windows search, type <code>Contact Support</code> , and press Enter.
Online help for operating system	www.dell.com/support/windows
Access top solutions, diagnostics, drivers and downloads, and learn more about your computer through videos, manuals and documents.	Your Dell computer is uniquely identified by a Service Tag or Express Service Code. To view relevant support resources for your Dell computer, enter the Service Tag or Express Service Code at www.dell.com/support . For more information on how to find the Service Tag for your computer, see Locate the Service Tag on your computer .
Dell knowledge base articles for a variety of computer concerns	<ol style="list-style-type: none"> 1. Go to www.dell.com/support. 2. On the menu bar at the top of the Support page, select Support > Knowledge Base. 3. In the Search field on the Knowledge Base page, type the keyword, topic, or model number, and then click or tap the search icon to view the related articles.

Contacting Dell

To contact Dell for sales, technical support, or customer service issues, see www.dell.com/contactdell.

 **NOTE:** Availability varies by country/region and product, and some services may not be available in your country/region.

 **NOTE:** If you do not have an active Internet connection, you can find contact information about your purchase invoice, packing slip, bill, or Dell product catalog.