

Vostro 15 3515

Service Manual



Notes, cautions, and warnings

 **NOTE:** A NOTE indicates important information that helps you make better use of your product.

 **CAUTION:** A CAUTION indicates either potential damage to hardware or loss of data and tells you how to avoid the problem.

 **WARNING:** A WARNING indicates a potential for property damage, personal injury, or death.

Chapter 1: Working inside your computer	6
Safety instructions.....	6
Before working inside your computer.....	6
Safety precautions.....	7
Electrostatic discharge—ESD protection.....	7
ESD field service kit	8
After working inside your computer.....	9
Chapter 2: Removing and installing components	10
Recommended tools.....	10
Screw list.....	10
Major components of Vostro 15 3515.....	11
Secure Digital Card.....	13
Removing the Secure Digital card.....	13
Installing the Secure Digital card.....	15
Base cover.....	16
Removing the base cover.....	16
Installing the base cover.....	18
Battery.....	20
Lithium-ion battery precautions.....	20
Removing the battery.....	21
Installing the battery.....	22
Removing the 4-cell battery.....	22
Installing the 4-cell battery.....	23
Disconnecting the battery cable.....	24
Connecting the battery cable.....	25
Solid-state drive.....	26
Removing the M.2 2230 solid-state drive.....	26
Installing the M.2 2230 solid-state drive.....	27
Removing the M.2 2280 solid-state drive.....	28
Installing the M.2 2280 solid-state drive.....	29
Wireless card.....	30
Removing the wireless card.....	30
Installing the wireless card.....	31
Input/Output board.....	33
Removing the Input/Output board.....	33
Installing the Input/Output board.....	33
Hard drive assembly.....	34
Removing the hard drive assembly.....	34
Installing the hard drive assembly.....	35
Memory modules.....	37
Removing the memory modules.....	37
Installing the memory modules.....	37
Speakers.....	38

Removing the speakers.....	38
Installing the speakers.....	39
Heat sink.....	40
Removing the heat sink.....	40
Installing the heat sink.....	41
Fan.....	42
Removing the fan.....	42
Installing the fan.....	43
Power button.....	44
Removing the power button.....	44
Installing the power button.....	45
Power-button with optional fingerprint reader.....	46
Removing the power button with optional fingerprint reader.....	46
Installing the power button with optional fingerprint reader.....	47
Display assembly.....	48
Removing the display assembly.....	48
Installing the display assembly.....	51
Hinge caps.....	54
Removing the hinge caps.....	54
Installing the hinge caps	55
Display bezel.....	57
Removing the display bezel.....	57
Installing the display bezel	58
Hinges.....	59
Removing the hinges.....	59
Installing the hinges	61
Display panel.....	62
Removing the display panel.....	62
Installing the display panel.....	64
Camera module.....	66
Removing the camera module.....	66
Installing the camera module.....	67
Touchpad.....	67
Removing the touchpad.....	67
Installing the touchpad.....	68
System board.....	70
System board connectors.....	70
Removing the system board.....	70
Installing the system board.....	72
Power-adapter port.....	74
Removing the power-adapter port.....	74
Installing the power-adapter port.....	75
Palm-rest and keyboard assembly.....	75
Removing the palmrest and keyboard assembly.....	75
Installing the palmrest and keyboard assembly.....	76

Chapter 3: Drivers and downloads..... 78











Chapter 4: System setup..... 79

Boot menu.....	79
Navigation keys.....	79
Boot Sequence.....	80
System setup options.....	80
Updating the BIOS.....	84
Updating the BIOS in Windows.....	84
Updating the BIOS in Linux and Ubuntu.....	84
Updating the BIOS using the USB drive in Windows.....	84
Updating the BIOS from the F12 One-Time boot menu.....	85
System and setup password.....	85
Assigning a system setup password.....	86
Deleting or changing an existing system setup password.....	86
Clearing BIOS (System Setup) and System passwords.....	87
Chapter 5: Troubleshooting.....	88
Handling swollen Lithium-ion batteries.....	88
Dell SupportAssist Pre-boot System Performance Check diagnostics.....	88
Running the SupportAssist Pre-Boot System Performance Check.....	89
Enhanced Pre-Boot System Assessment (ePSA) diagnostics.....	89
Running SupportAssist diagnostics.....	89
System diagnostic lights.....	90
Updating the BIOS in Windows.....	91
Updating the BIOS using the USB drive in Windows.....	91
Backup media and recovery options.....	92
WiFi power cycle.....	92
Drain residual flea power (perform hard reset).....	92
Chapter 6: Getting help and contacting Dell.....	93

Working inside your computer

Safety instructions

Use the following safety guidelines to protect your computer from potential damage and to ensure your personal safety. Unless otherwise noted, each procedure included in this document assumes that you have read the safety information that shipped with your computer.

-  **WARNING:** Before working inside your computer, read the safety information that is shipped with your computer. For more safety best practices, see the Regulatory Compliance home page at www.dell.com/regulatory_compliance.
-  **WARNING:** Disconnect your computer from all power sources before opening the computer cover or panels. After you finish working inside the computer, replace all covers, panels, and screws before connecting your computer to an electrical outlet.
-  **CAUTION:** To avoid damaging the computer, ensure that the work surface is flat, dry, and clean.
-  **CAUTION:** To avoid damaging the components and cards, handle them by their edges, and avoid touching the pins and the contacts.
-  **CAUTION:** You should only perform troubleshooting and repairs as authorized or directed by the Dell technical assistance team. Damage due to servicing that is not authorized by Dell is not covered by your warranty. See the safety instructions that is shipped with the product or at www.dell.com/regulatory_compliance.
-  **CAUTION:** Before touching anything inside your computer, ground yourself by touching an unpainted metal surface, such as the metal at the back of the computer. While you work, periodically touch an unpainted metal surface to dissipate static electricity which could harm internal components.
-  **CAUTION:** When you disconnect a cable, pull it by its connector or its pull tab, not the cable itself. Some cables have connectors with locking tabs or thumbscrews that you must disengage before disconnecting the cable. When disconnecting cables, keep them evenly aligned to avoid bending the connector pins. When connecting cables, ensure that the ports and the connectors are correctly oriented and aligned.
-  **CAUTION:** Press and eject any installed card from the media-card reader.
-  **CAUTION:** Exercise caution when handling Lithium-ion batteries in laptops. Swollen batteries should not be used and should be replaced and disposed properly.
-  **NOTE:** The color of your computer and certain components may appear differently than shown in this document.

Before working inside your computer

About this task

-  **NOTE:** The images in this document may differ from your computer depending on the configuration you ordered.

Steps

1. Save and close all open files and exit all open applications.
2. Shut down your computer. Click **Start** >  **Power** > **Shut down**.

 **NOTE:** If you are using a different operating system, see the documentation of your operating system for shut-down instructions.

3. Disconnect your computer and all attached devices from their electrical outlets.
4. Disconnect all attached network devices and peripherals, such as keyboard, mouse, and monitor from your computer.

 **CAUTION:** To disconnect a network cable, first unplug the cable from your computer and then unplug the cable from the network device.

5. Remove any media card and optical disc from your computer, if applicable.

Safety precautions

The safety precautions chapter details the primary steps to be taken before performing any disassembly instructions.

Observe the following safety precautions before you perform any installation or break/fix procedures involving disassembly or reassembly:

- Turn off the system and all attached peripherals.
- Disconnect the system and all attached peripherals from AC power.
- Disconnect all network cables, telephone, and telecommunications lines from the system.
- Use an ESD field service kit when working inside any notebook to avoid electrostatic discharge (ESD) damage.
- After removing any system component, carefully place the removed component on an anti-static mat.
- Wear shoes with non-conductive rubber soles to reduce the chance of getting electrocuted.

Standby power

Dell products with standby power must be unplugged before you open the case. Systems that incorporate standby power are essentially powered while turned off. The internal power enables the system to be remotely turned on (wake on LAN) and suspended into a sleep mode and has other advanced power management features.

Unplugging, pressing and holding the power button for 20 seconds should discharge residual power in the system board. Remove the battery from notebooks.

Bonding

Bonding is a method for connecting two or more grounding conductors to the same electrical potential. This is done through the use of a field service electrostatic discharge (ESD) kit. When connecting a bonding wire, ensure that it is connected to bare metal and never to a painted or non-metal surface. The wrist strap should be secure and in full contact with your skin, and ensure that you remove all jewelry such as watches, bracelets, or rings prior to bonding yourself and the equipment.

Electrostatic discharge—ESD protection

ESD is a major concern when you handle electronic components, especially sensitive components such as expansion cards, processors, memory DIMMs, and system boards. Very slight charges can damage circuits in ways that may not be obvious, such as intermittent problems or a shortened product life span. As the industry pushes for lower power requirements and increased density, ESD protection is an increasing concern.

Due to the increased density of semiconductors used in recent Dell products, the sensitivity to static damage is now higher than in previous Dell products. For this reason, some previously approved methods of handling parts are no longer applicable.

Two recognized types of ESD damage are catastrophic and intermittent failures.

- **Catastrophic** – Catastrophic failures represent approximately 20 percent of ESD-related failures. The damage causes an immediate and complete loss of device functionality. An example of catastrophic failure is a memory DIMM that has received a static shock and immediately generates a "No POST/No Video" symptom with a beep code emitted for missing or nonfunctional memory.
- **Intermittent** – Intermittent failures represent approximately 80 percent of ESD-related failures. The high rate of intermittent failures means that most of the time when damage occurs, it is not immediately recognizable. The DIMM receives a static shock, but the tracing is merely weakened and does not immediately produce outward symptoms related to the damage. The weakened trace may take weeks or months to melt, and in the meantime may cause degradation of memory integrity, intermittent memory errors, etc.

The more difficult type of damage to recognize and troubleshoot is the intermittent (also called latent or "walking wounded") failure.

Perform the following steps to prevent ESD damage:

- Use a wired ESD wrist strap that is properly grounded. The use of wireless anti-static straps is no longer allowed; they do not provide adequate protection. Touching the chassis before handling parts does not ensure adequate ESD protection on parts with increased sensitivity to ESD damage.
- Handle all static-sensitive components in a static-safe area. If possible, use anti-static floor pads and workbench pads.
- When unpacking a static-sensitive component from its shipping carton, do not remove the component from the anti-static packing material until you are ready to install the component. Before unwrapping the anti-static packaging, ensure that you discharge static electricity from your body.
- Before transporting a static-sensitive component, place it in an anti-static container or packaging.

ESD field service kit

The unmonitored Field Service kit is the most commonly used service kit. Each Field Service kit includes three main components: anti-static mat, wrist strap, and bonding wire.

Components of an ESD field service kit

The components of an ESD field service kit are:

- **Anti-Static Mat** – The anti-static mat is dissipative and parts can be placed on it during service procedures. When using an anti-static mat, your wrist strap should be snug and the bonding wire should be connected to the mat and to any bare metal on the system being worked on. Once deployed properly, service parts can be removed from the ESD bag and placed directly on the mat. ESD-sensitive items are safe in your hand, on the ESD mat, in the system, or inside a bag.
- **Wrist Strap and Bonding Wire** – The wrist strap and bonding wire can be either directly connected between your wrist and bare metal on the hardware if the ESD mat is not required, or connected to the anti-static mat to protect hardware that is temporarily placed on the mat. The physical connection of the wrist strap and bonding wire between your skin, the ESD mat, and the hardware is known as bonding. Use only Field Service kits with a wrist strap, mat, and bonding wire. Never use wireless wrist straps. Always be aware that the internal wires of a wrist strap are prone to damage from normal wear and tear, and must be checked regularly with a wrist strap tester in order to avoid accidental ESD hardware damage. It is recommended to test the wrist strap and bonding wire at least once per week.
- **ESD Wrist Strap Tester** – The wires inside of an ESD strap are prone to damage over time. When using an unmonitored kit, it is a best practice to regularly test the strap prior to each service call, and at a minimum, test once per week. A wrist strap tester is the best method for doing this test. If you do not have your own wrist strap tester, check with your regional office to find out if they have one. To perform the test, plug the wrist-strap's bonding-wire into the tester while it is strapped to your wrist and push the button to test. A green LED is lit if the test is successful; a red LED is lit and an alarm sounds if the test fails.
- **Insulator Elements** – It is critical to keep ESD sensitive devices, such as plastic heat sink casings, away from internal parts that are insulators and often highly charged.
- **Working Environment** – Before deploying the ESD Field Service kit, assess the situation at the customer location. For example, deploying the kit for a server environment is different than for a desktop or portable environment. Servers are typically installed in a rack within a data center; desktops or portables are typically placed on office desks or cubicles. Always look for a large open flat work area that is free of clutter and large enough to deploy the ESD kit with additional space to accommodate the type of system that is being repaired. The workspace should also be free of insulators that can cause an ESD event. On the work area, insulators such as Styrofoam and other plastics should always be moved at least 12 inches or 30 centimeters away from sensitive parts before physically handling any hardware components
- **ESD Packaging** – All ESD-sensitive devices must be shipped and received in static-safe packaging. Metal, static-shielded bags are preferred. However, you should always return the damaged part using the same ESD bag and packaging that the new part arrived in. The ESD bag should be folded over and taped shut and all the same foam packing material should be used in the original box that the new part arrived in. ESD-sensitive devices should be removed from packaging only at an ESD-protected work surface, and parts should never be placed on top of the ESD bag because only the inside of the bag is shielded. Always place parts in your hand, on the ESD mat, in the system, or inside an anti-static bag.
- **Transporting Sensitive Components** – When transporting ESD sensitive components such as replacement parts or parts to be returned to Dell, it is critical to place these parts in anti-static bags for safe transport.

ESD protection summary

It is recommended that all field service technicians use the traditional wired ESD grounding wrist strap and protective anti-static mat at all times when servicing Dell products. In addition, it is critical that technicians keep sensitive parts separate from all insulator parts while performing service and that they use anti-static bags for transporting sensitive components.

After working inside your computer

About this task

 **CAUTION:** Leaving stray or loose screws inside your computer may severely damage your computer.

Steps

1. Replace all screws and ensure that no stray screws remain inside your computer.
2. Connect any external devices, peripherals, or cables you removed before working on your computer.
3. Replace any media cards, discs, or any other parts that you removed before working on your computer.
4. Connect your computer and all attached devices to their electrical outlets.
5. Turn on your computer.

Removing and installing components

NOTE: The images in this document may differ from your computer depending on the configuration you ordered.

Recommended tools

The procedures in this document may require the following tools:

- Phillips screwdriver #0
- Phillips screwdriver #1
- Plastic scribe

Screw list

NOTE: When removing screws from a component, it is recommended to note the screw type, the quantity of screws, and then place them in a screw storage box. This is to ensure that the correct number of screws and correct screw type is restored when the component is replaced.

NOTE: Some computers have magnetic surfaces. Ensure that the screws are not left attached to such surfaces when replacing a component.

NOTE: Screw color may vary with the configuration ordered.

Table 1. Screw list













Component	Screw type	Quantity	Screw image
Base cover	M2x5	6	
	Captive screw	2	
3-cell battery	M2x3	3	
4-cell battery	M2x3	4	
M.2 2230 solid-state drive	M2x2	1	
M.2 2280 solid-state drive	M2x2	1	
Wireless card	M2x3	1	
I/O board	M2x3	2	

Table 1. Screw list (continued)

Component	Screw type	Quantity	Screw image
Hard-drive assembly Hard-drive bracket	M2x3 M3x3	4 4	
Heat sink	M2x3	4	
Fan	M2x5	2	
Power button with optional fingerprint reader	M2x2	1	
Display assembly	M2.5x5	4	
System board	M2x3 M2x2	3 1	
Touchpad Touchpad bracket	M2x2 Big Head M2x2 Big Head	2 3	

Major components of Vostro 15 3515

The following image shows the major components of Vostro 15 3515.

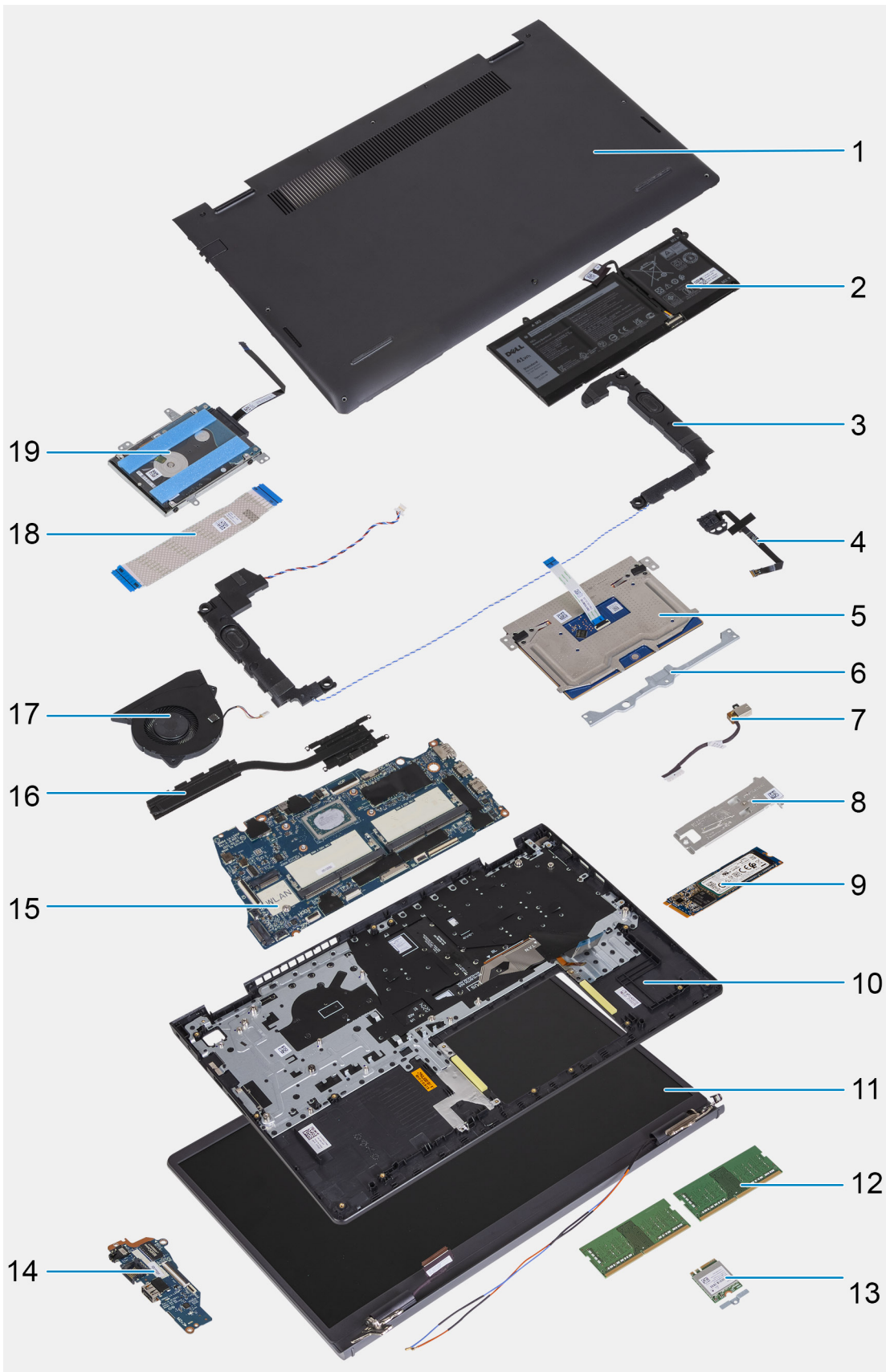

1. Base cover
2. Battery
3. Speakers
4. Power-button with optional fingerprint-reader

5. Touchpad
6. Touchpad bracket
7. Power-adapter port
8. Solid-state drive thermal plate
9. M.2 2280 solid-state drive
10. Palm-rest and keyboard assembly
11. Display assembly
12. Memory modules
13. Wireless card
14. Input/Output board
15. System board
16. Heat sink
17. Fan
18. Input output board FFC
19. Hard drive

 **NOTE:** Dell provides a list of components and their part numbers for the original system configuration purchased. These parts are available according to warranty coverages purchased by the customer. Contact your Dell sales representative for purchase options.

Secure Digital Card

Removing the Secure Digital card

Prerequisites

1. Follow the procedure in [Before working inside your computer](#)

About this task

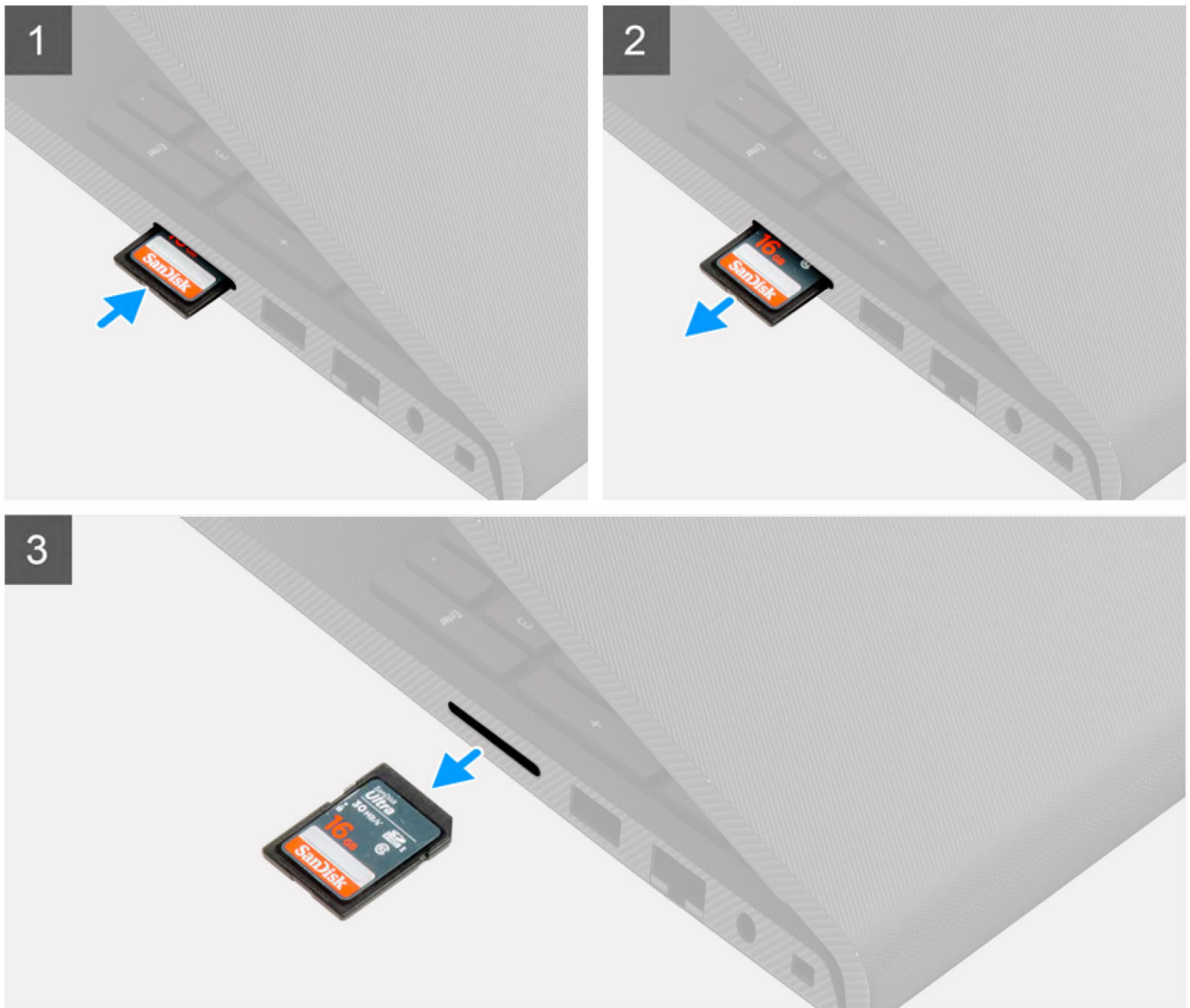

Steps

1. Push the secure digital card to release it from the card slot.
2. Slide the secure digital card out of the computer.

Installing the Secure Digital card

Prerequisites

If you are replacing a component, remove the existing component before performing the installation procedure.

About this task

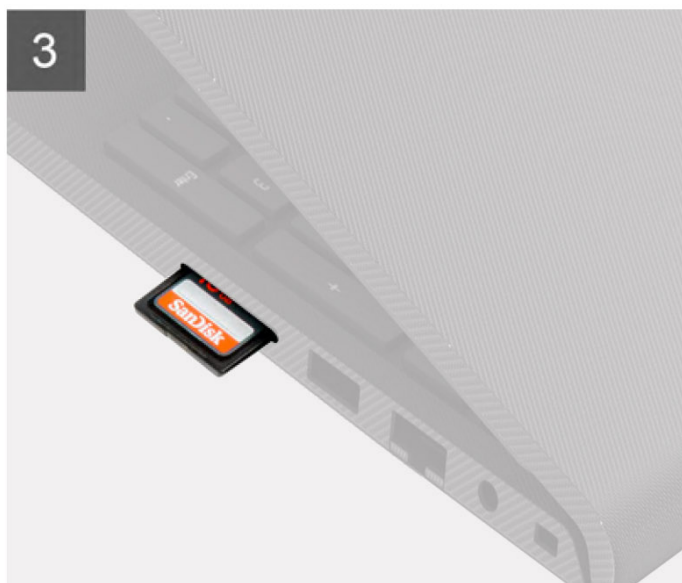
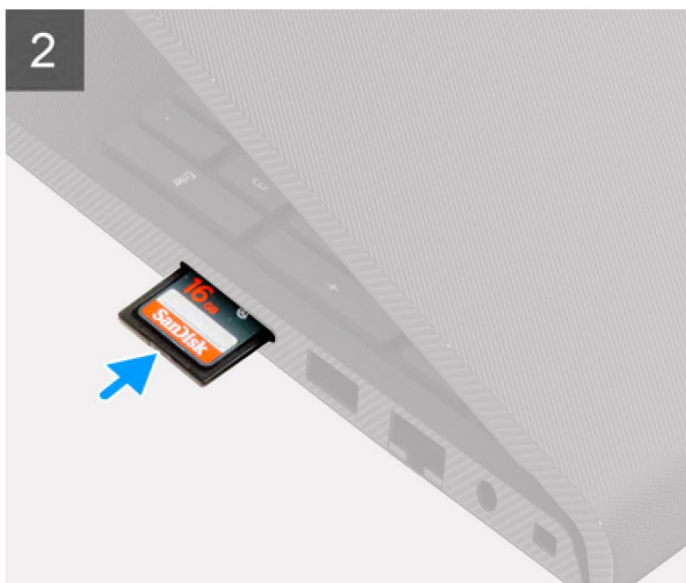

Steps

Slide the secure digital into the slot until it clicks into place.

Next steps

1. Follow the procedure in [After working inside your computer](#)

Base cover

Removing the base cover

Prerequisites

1. Follow the procedure in [Before working inside your computer](#).
2. Remove the [SD card](#).

About this task

NOTE: Before removing the base cover, ensure that there is no SD card installed in the SD card slot on your computer.

The following images indicate the location of the base cover and provides a visual representation of the removal procedure.

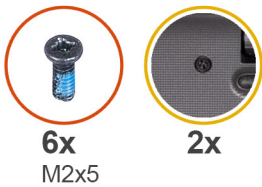

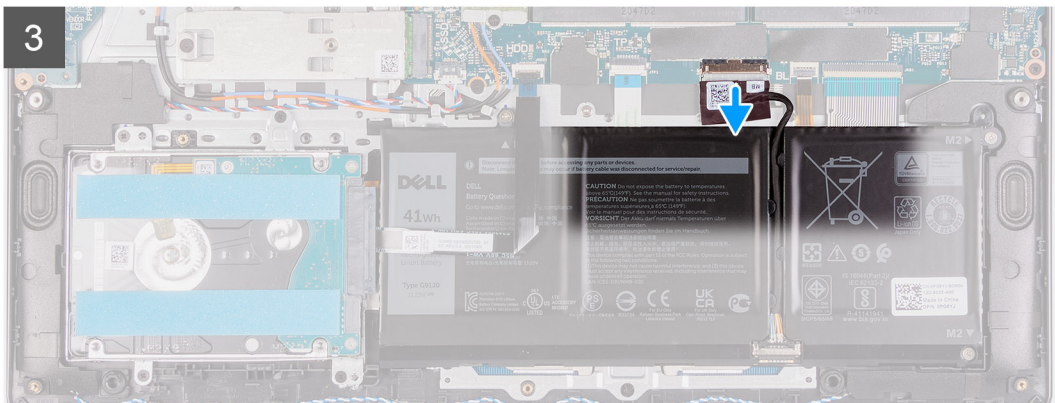
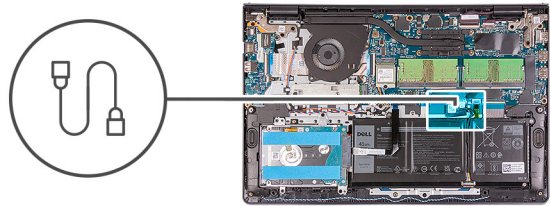
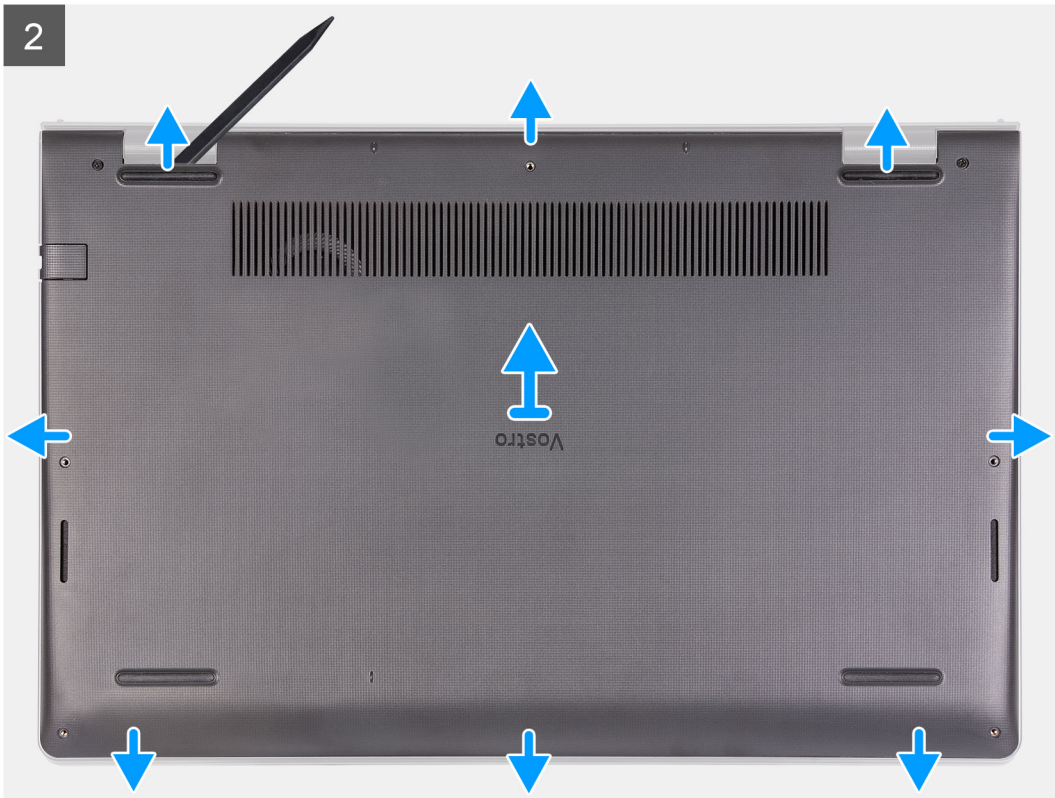



Steps

1. Remove the six screws (M2x5) that secure the base cover to the palmrest and keyboard assembly.
2. Loosen the two captive screws.
3. Using a plastic scribe, pry open the base cover from the recesses located in the U-shaped indents at the top edge of the base cover near the hinges.
4. Lift and slide the base cover off the palmrest and keyboard assembly.
5. Disconnect the battery cable from the system board.
6. Press and hold the power button for five seconds to ground the computer and drain the flea power.

Installing the base cover

Prerequisites

If you are replacing a component, remove the existing component before performing the installation process.

About this task

The following images indicate the location of the base cover and provides a visual representation of the installation procedure.

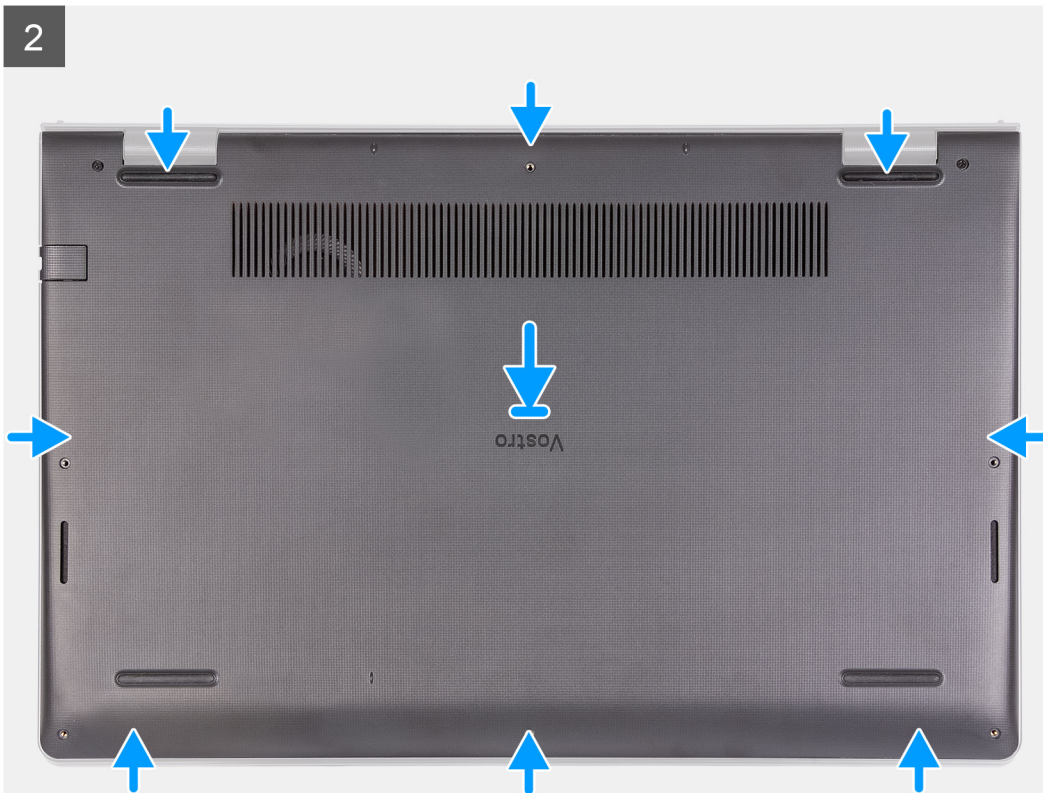
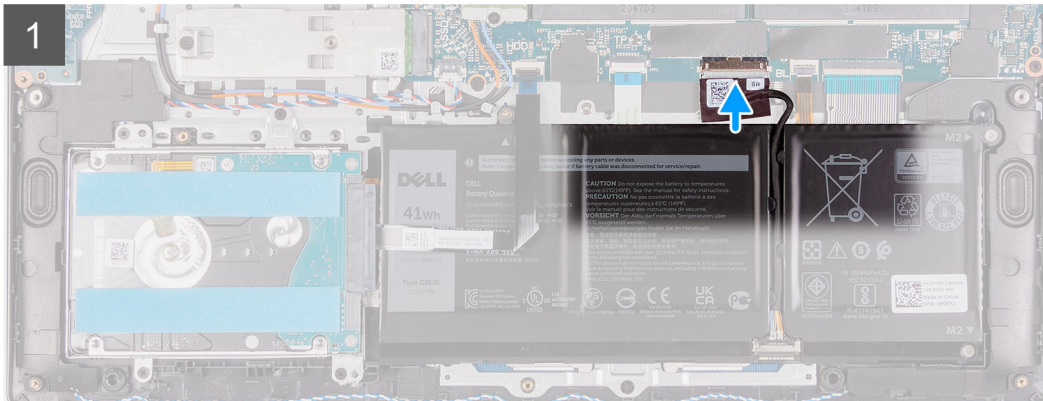
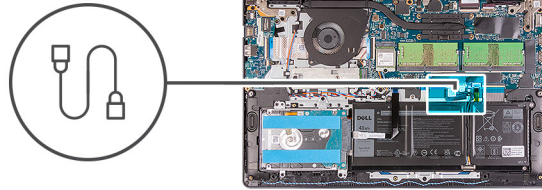

3



Steps

1. Connect the battery cable to the connector on the system board.
2. Place and snap the base cover into place on the palmrest and keyboard assembly.
3. Tighten the two captive screws on the base cover.
4. Replace the six screws (M2x5) that secure the base cover to the palmrest and keyboard assembly.

Next steps

1. Install the [SD card](#).
2. Follow the procedure in [After working inside your computer](#).

Battery

Lithium-ion battery precautions

⚠ CAUTION:

- Exercise caution when handling Lithium-ion batteries.
- Discharge the battery completely before removing it. Disconnect the AC power adapter from the system and operate the computer solely on battery power—the battery is fully discharged when the computer no longer turns on when the power button is pressed.
- Do not crush, drop, mutilate, or penetrate the battery with foreign objects.
- Do not expose the battery to high temperatures, or disassemble battery packs and cells.
- Do not apply pressure to the surface of the battery.
- Do not bend the battery.
- Do not use tools of any kind to pry on or against the battery.
- Ensure any screws during the servicing of this product are not lost or misplaced, to prevent accidental puncture or damage to the battery and other system components.

- If the battery gets stuck inside your computer as a result of swelling, do not try to release it as puncturing, bending, or crushing a lithium-ion battery can be dangerous. In such an instance, contact Dell technical support for assistance. See www.dell.com/contactdell.
- Always purchase genuine batteries from www.dell.com or authorized Dell partners and resellers.
- Swollen batteries should not be used and should be replaced and disposed properly. For guidelines on how to handle and replace swollen Lithium-ion batteries, see [Handling swollen Lithium-ion batteries](#).

Removing the battery

Prerequisites

1. Follow the procedure in [Before working inside your computer](#).
2. Remove the [SD card](#).
3. Remove the [base cover](#).

About this task

The following images indicate the location of the battery and provides a visual representation of the removal procedure.

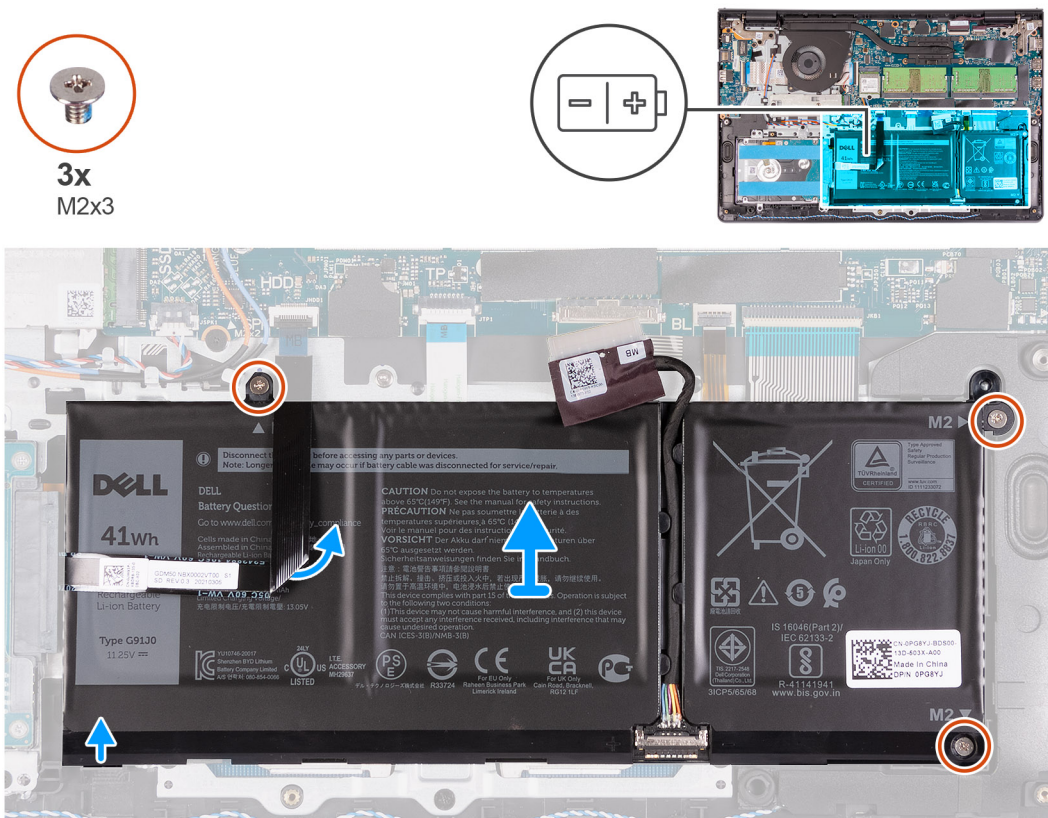

Steps

1. Disconnect the battery cable from the system board, if applicable.
2. Remove the three screws (M2x3) that secure the battery to the palmrest and keyboard assembly.
3. Peel the hard drive Flexible Flat Cable from the battery.
4. Remove the battery from the palmrest and keyboard assembly.

CAUTION: Carefully remove the battery so that the battery does not tug on the hard drive Flexible Flat Cable.

Installing the battery

Prerequisites

If you are replacing a component, remove the existing component before performing the installation process.

About this task

The following images indicate the location of the battery and provides a visual representation of the installation procedure.



3x
M2x3

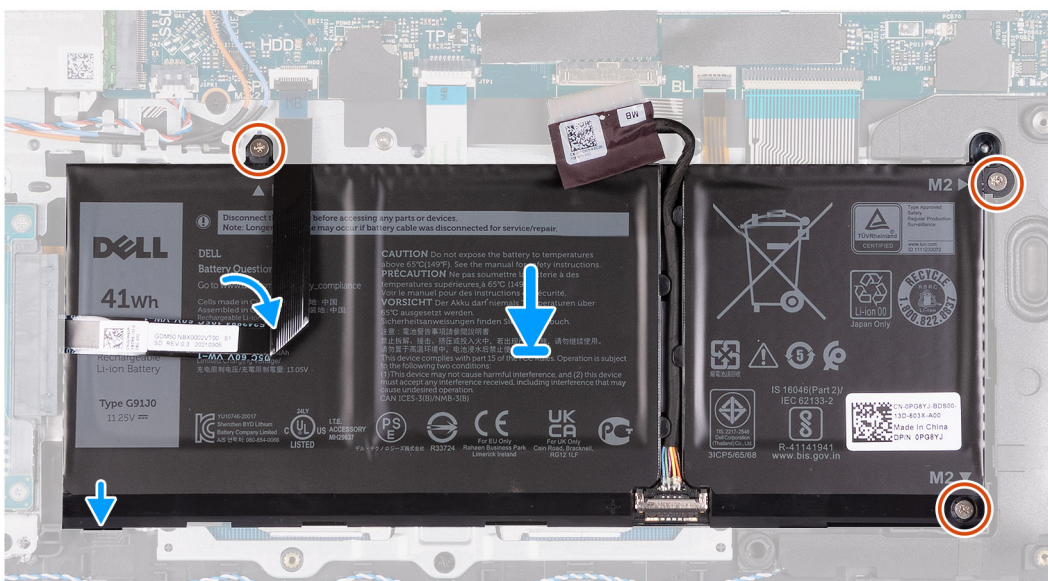
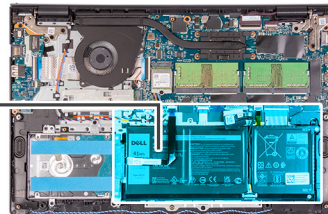
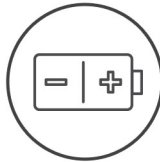

Steps

1. Place the battery on the palmrest and keyboard assembly.
2. Align the screw holes on the battery to the screw holes on the palmrest and keyboard assembly.
3. Replace the three screws (M2x3) that secure the battery to the palmrest and keyboard assembly.
4. Adhere the hard drive Flexible Flat Cable on to the battery.
5. Connect the battery cable to the connector on the system board.

Next steps

1. Install the [base cover](#).
2. Install the [SD card](#).
3. Follow the procedure in [After working inside your computer](#).

Removing the 4-cell battery

Prerequisites

1. Follow the procedure in [before working inside your computer](#).
2. Remove the [SD card](#).
3. Remove the [base cover](#).

About this task

The following images indicate the location of the battery and provides a visual representation of the installation procedure.

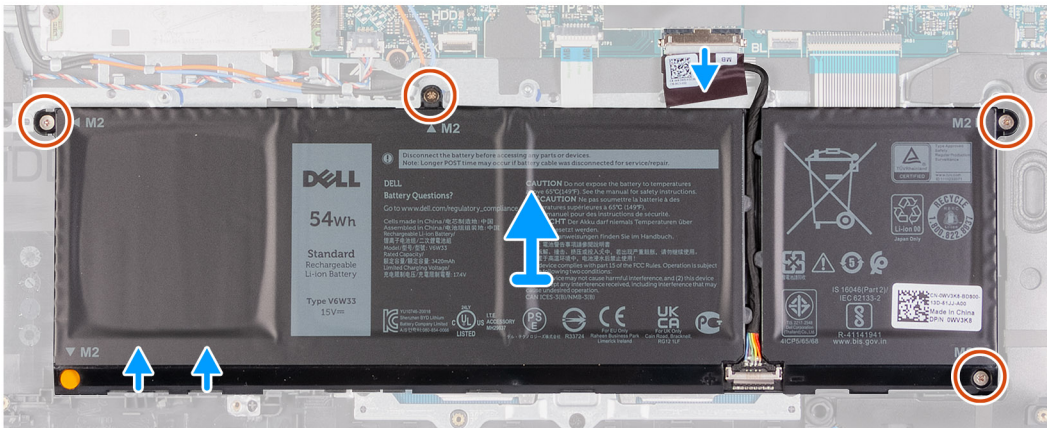
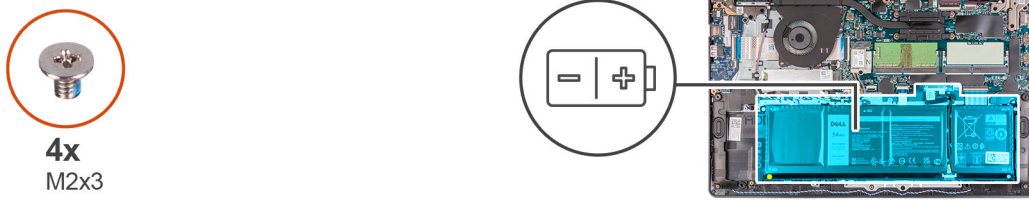

Steps

1. Disconnect the battery cable from the connector on the system board.
2. Remove the four (M2x3) screws that secure the battery to the palmrest.
3. Lift and move the battery away from the computer.

Installing the 4-cell battery

Prerequisites

If you are replacing a component, remove the existing component before performing the installation process.

About this task

The following images indicate the location of the battery and provides a visual representation of the installation procedure.

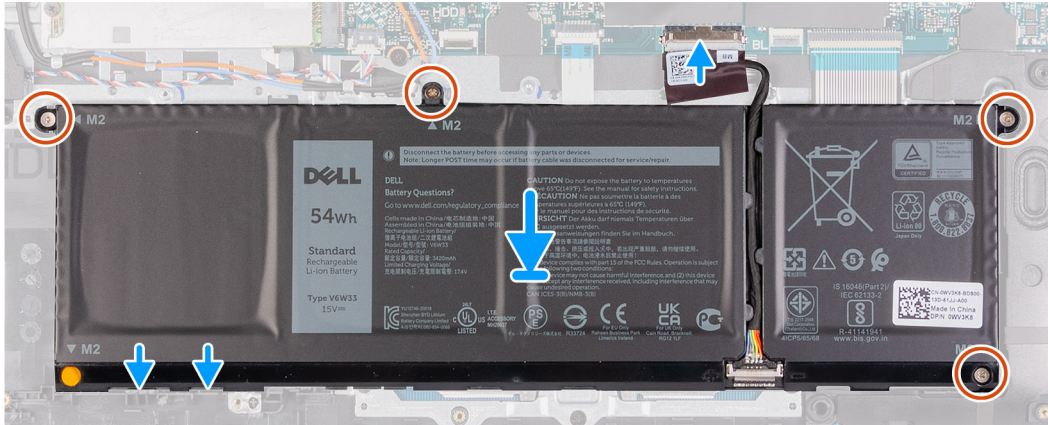
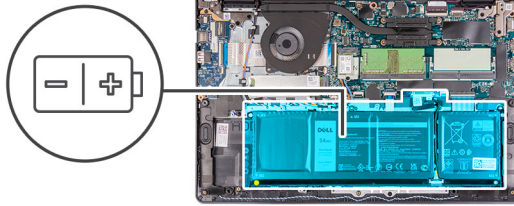

Steps

1. Place the battery on the palm-rest and keyboard assembly.
2. Align the screw holes on the battery to the screw holes on the palmrest and keyboard assembly.
3. Replace the three screws (M2x3) that secure the battery to the palmrest and keyboard assembly.
4. Connect the battery cable to the connector on the system board.

Next steps

1. Install the [base cover](#).
2. Install the [SD card](#).
3. Follow the procedure in [after working inside your computer](#).

Disconnecting the battery cable

Prerequisites

1. Follow the procedure in [Before working inside your computer](#).
2. Remove the [SD card](#).
3. Remove the [base cover](#).

About this task

The following images indicate the location of the battery cable and provides a visual representation of the removal procedure.

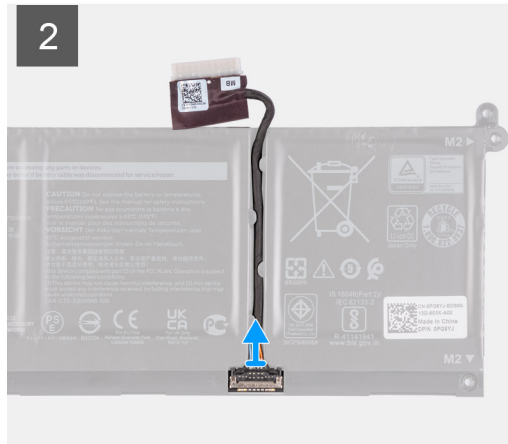
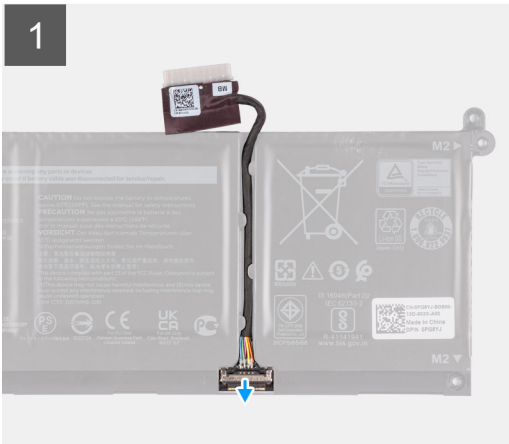

Steps

1. Lift the latch on the battery cable.
2. Disconnect the battery cable from the connector on the battery.

Connecting the battery cable

Prerequisites

If you are replacing a component, remove the existing component before performing the installation process.

About this task

The following images indicate the location of the battery cable and provides a visual representation of the installation procedure.

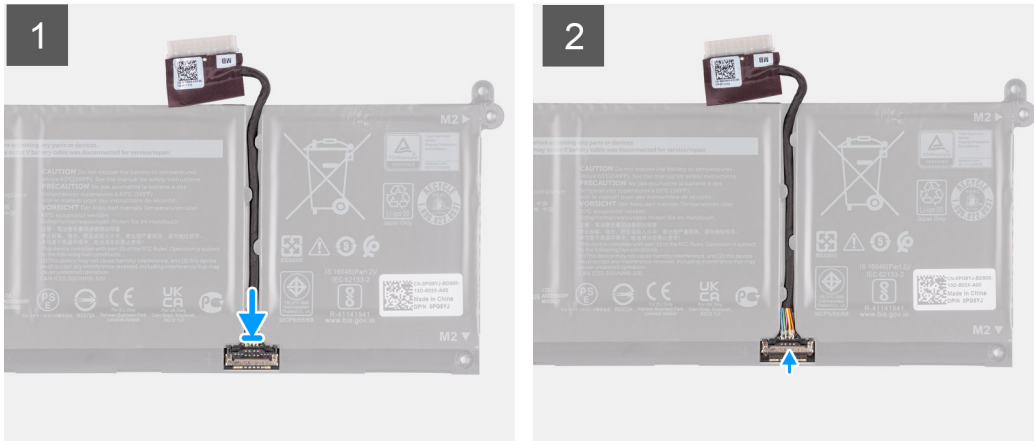

Steps

1. Connect the battery cable to the connector on the battery.
2. Close the latch on the battery cable connector to secure it to the battery.

Next steps

1. Install the [base cover](#).
2. Install the [SD card](#).
3. Follow the procedure in [after working inside your computer](#).

Solid-state drive

Removing the M.2 2230 solid-state drive

Prerequisites

1. Follow the procedure in [Before working inside your computer](#).
2. Remove the [SD card](#).
3. Remove the [base cover](#).

About this task

- NOTE:** This procedure applies only to computers shipped with an M.2 2230 solid-state drive installed.
- NOTE:** The M.2 card installed on your computer will depend on the configuration ordered. Supported card configurations on the M.2 card slot:
 - M.2 2230 solid-state drive + 2230 mounting bracket
 - M.2 2280 solid-state drive

The following images indicate the location of the M.2 2230 solid-state drive and provides a visual representation of the removal procedure.

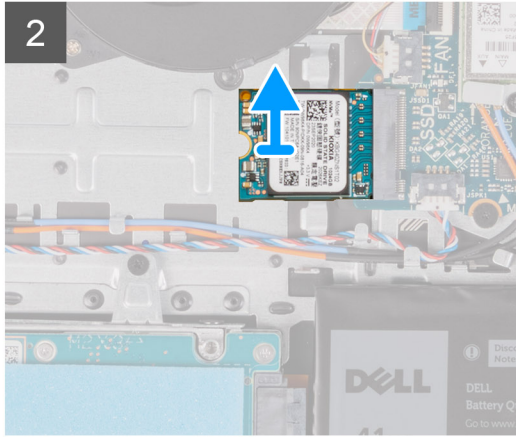
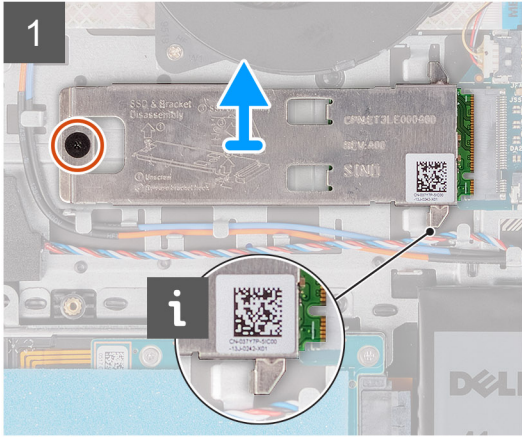
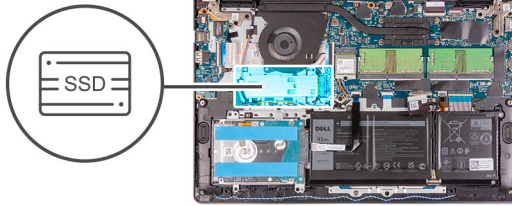

Steps

1. Remove the (M2x2) screw that secures the M.2 2230 thermal plate to the palmrest and keyboard assembly.
2. Slide and remove the M.2 2230 mounting bracket out from the system board.
3. Slide and remove the M.2 2230 solid-state drive from the M.2 card slot on the system board.

Installing the M.2 2230 solid-state drive

Prerequisites

If you are replacing a component, remove the existing component before performing the installation process.

About this task

- NOTE:** This procedure applies if you are installing a M.2 2230 solid-state drive.
- NOTE:** The M.2 card installed on your computer will depend on the configuration ordered. Supported card configurations on the M.2 card slot:
 - M.2 2230 solid-state drive + 2230 mounting bracket
 - M.2 2280 solid-state drive

The following images indicate the location of the M.2 2230 solid-state drive and provides a visual representation of the installation procedure.



1x
M2x2

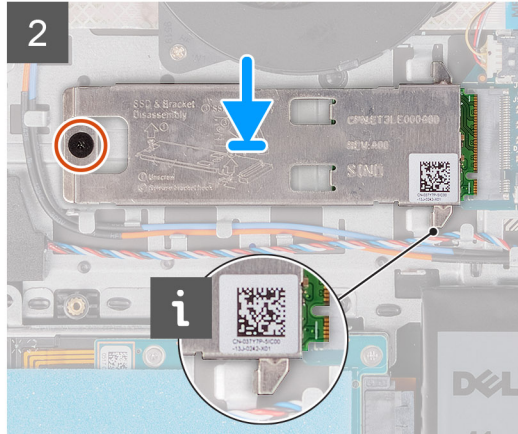
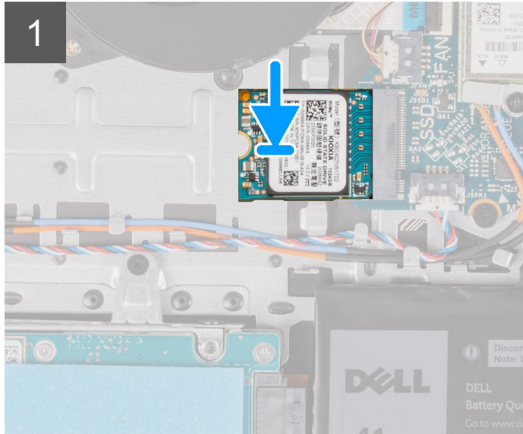
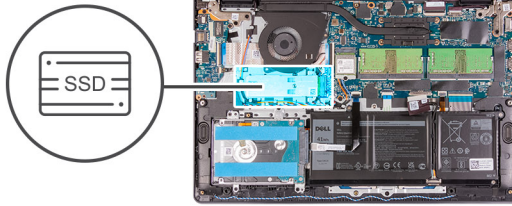

Steps

1. Align the notch on the M.2 2230 solid-state drive with the tab on the M.2 card slot on the system board..
2. Slide the M.2 2230 solid-state drive into the M.2 card slot on the system board .
3. Place the M.2 thermal plate on the M.2 2280 solid-state drive.

i **NOTE:** When installing the M.2 solid-state drive to the system, tuck the tabs on the thermal plate under the hooks on the palm rest.

4. Align the screw holes on the M.2 thermal plate with the screw holes on the palmrest and keyboard assembly.
5. Replace the (M2x2) screw that secures the M.2 thermal plate to the palmrest and keyboard assembly

Next steps

1. Install the [base cover](#).
2. Install the [SD card](#).
3. Follow the procedure in [After working inside your computer](#).

Removing the M.2 2280 solid-state drive

Prerequisites

1. Follow the procedure in [Before working inside your computer](#).
2. Remove the [SD card](#).
3. Remove the [base cover](#).

About this task

i **NOTE:** This procedure applies only to computers shipped with a M.2 2280 solid-state drive installed.

i **NOTE:** The M.2 card installed on your computer will depend on the configuration ordered. Supported card configurations on the M.2 card slot:

- M.2 2230 solid-state drive + 2230 mounting bracket
- M.2 2280 solid-state drive

The following images indicate the location of the M.2 2280 solid-state drive and provides a visual representation of the removal procedure.



1x
M2x2

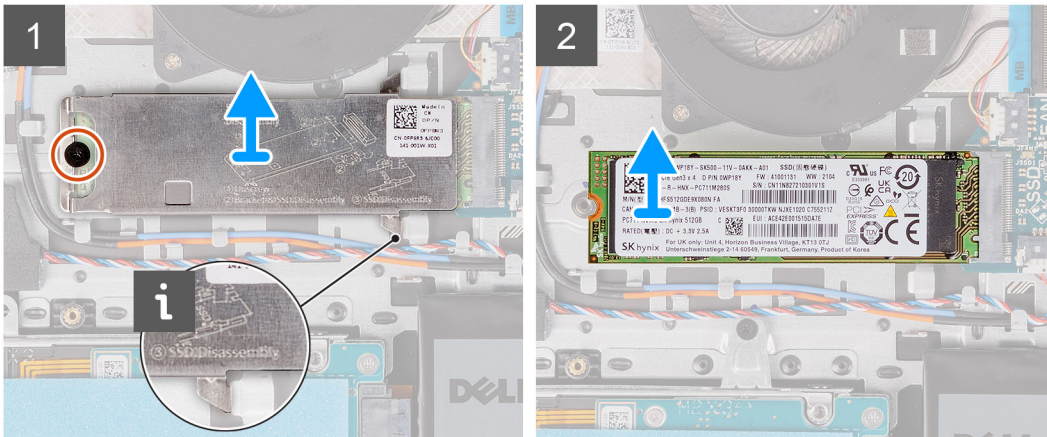
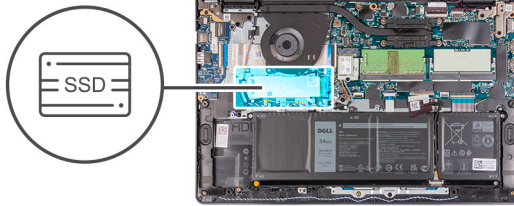

Steps

1. Remove the (M2x2) screws that secure the M.2 thermal plate to the palmrest and keyboard assembly.
2. Lift the M.2 thermal plate from the palmrest and keyboard assembly.
3. Slide and remove the M.2 2280 solid-state drive from the M.2 card slot on the system board.

Installing the M.2 2280 solid-state drive

Prerequisites

If you are replacing a component, remove the existing component before performing the installation process.

About this task

- NOTE:** This procedure applies if you are installing a M.2 2280 solid-state drive.
- NOTE:** The M.2 card installed on your computer will depend on the configuration ordered. Supported card configurations on the M.2 card slot:
 - M.2 2230 solid-state drive + 2230 mounting bracket
 - M.2 2280 solid-state drive

The following images indicate the location of the M.2 2280 solid-state drive and provides a visual representation of the installation procedure.



1x
M2x2

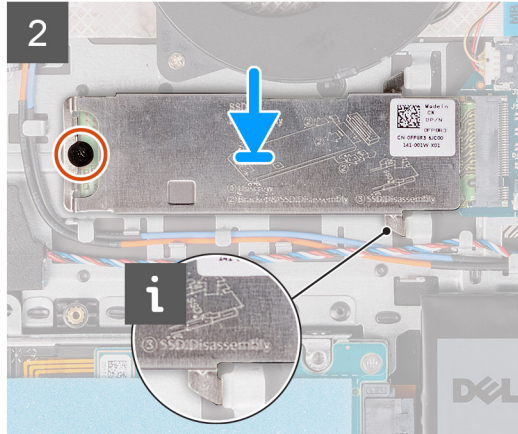
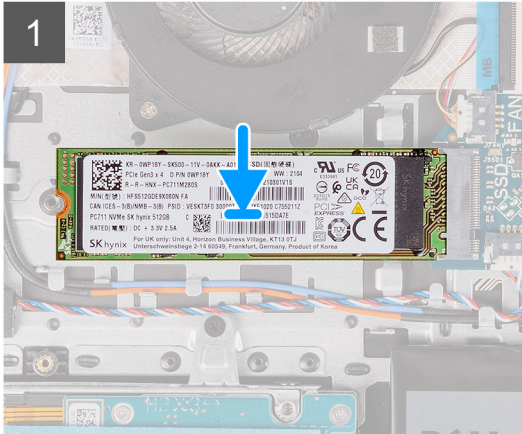

Steps

1. Align the notch on the M.2 2280 solid-state drive with the tab on the M.2 card slot on the system board.
2. Slide the M.2 2280 solid-state drive into the M.2 card slot on the system board.
3. Place the M.2 thermal plate on the M.2 2280 solid-state drive.

i **NOTE:** When installing the M.2 solid-state drive to the system, tuck the tabs on the thermal plate under the hooks on the palmrest and keyboard assembly.

4. Align the screw holes on the M.2 thermal plate with the screw holes on the palmrest and keyboard assembly.
5. Replace the (M2x2) screw that secures the M.2 thermal plate to the palmrest and keyboard assembly.

Next steps

1. Install the [base cover](#).
2. Install the [SD card](#).
3. Follow the procedure in [After working inside your computer](#).

Wireless card

Removing the wireless card

Prerequisites

1. Follow the procedure in [Before working inside your computer](#).
2. Remove the [SD card](#).
3. Remove the [base cover](#).

About this task

The following images indicate the location of the wireless card and provides a visual representation of the removal procedure.



1x
M2x3

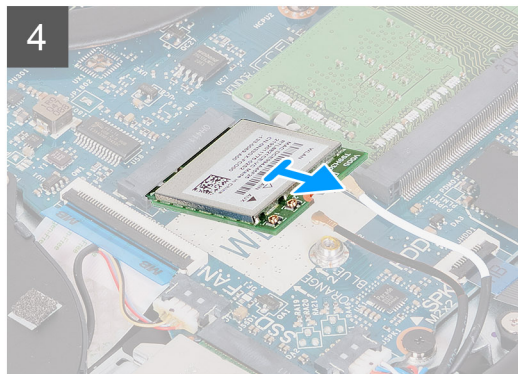
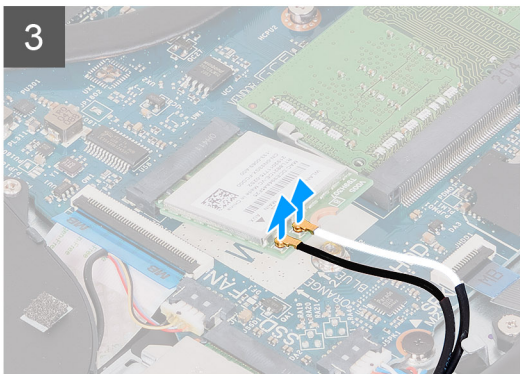
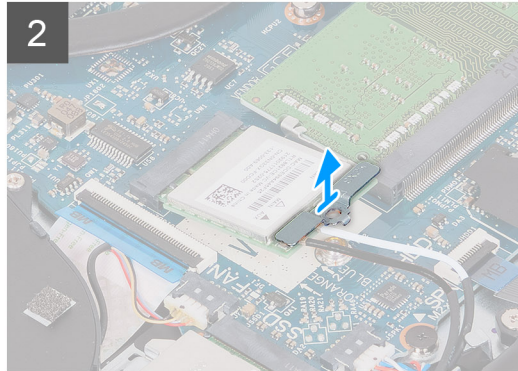
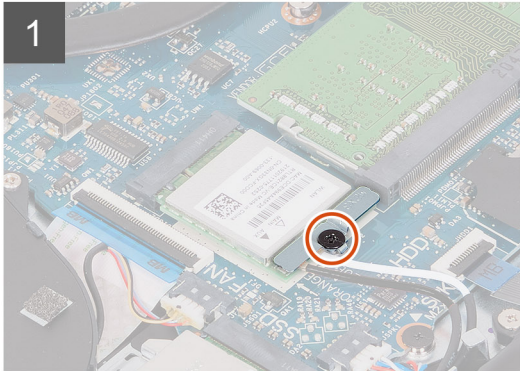
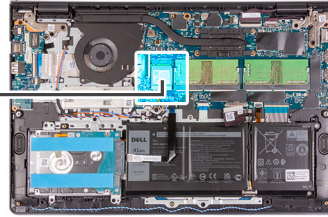

Steps

1. Remove the screw (M2x3) that secures the wireless card bracket to the system board.
2. Lift the wireless card bracket from the wireless card.
3. Disconnect the antenna cables from the wireless card.
4. Slide and remove the wireless card from the WLAN slot on the system board.

Installing the wireless card

Prerequisites

If you are replacing a component, remove the existing component before performing the installation process.

About this task

The following images indicate the location of the wireless card and provides a visual representation of the installation procedure.



1x
M2x3

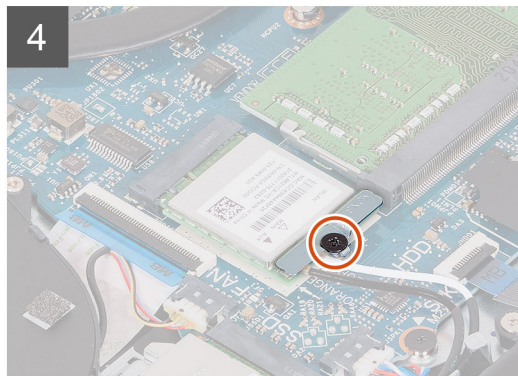
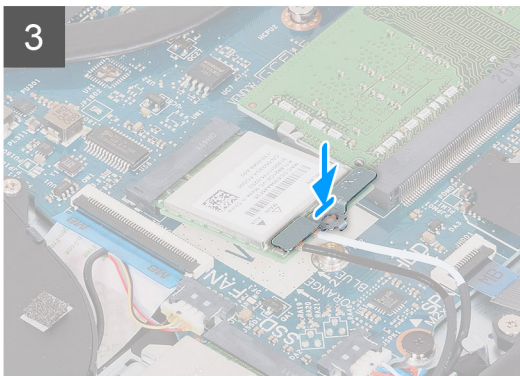
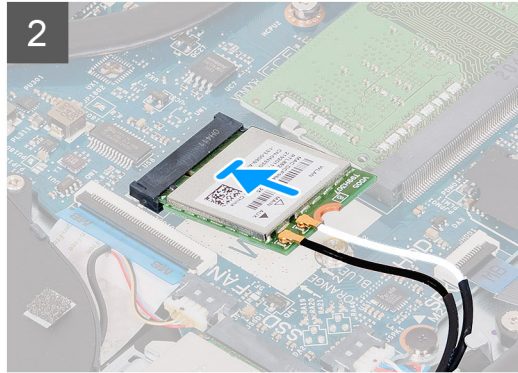
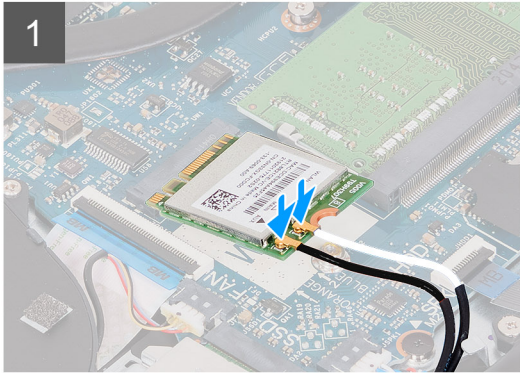
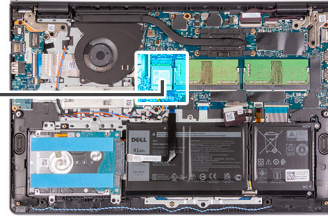

Steps

1. Connect the antenna cables to the wireless card.

The following table provides the antenna-cable color scheme for the wireless card supported by your computer.

Table 2. Antenna-cable color scheme

Connectors on the wireless card	Antenna-cable color
Main (white triangle)	White
Auxiliary (black triangle)	Black

2. Slide the wireless card into the WLAN slot on the system board.
3. Place the wireless card bracket on the wireless card.
4. Replace the screw (M2x3) that secures the wireless card bracket to the system board.

Next steps

1. Install the [base cover](#).
2. Install the [SD card](#).
3. Follow the procedure in [After working inside your computer](#).

Input/Output board

Removing the Input/Output board

Prerequisites

1. Follow the procedure in [Before working inside your computer](#).
2. Remove the [SD card](#).
3. Remove the [base cover](#).

About this task

The following images indicate the location of the Input/Output board and provides a visual representation of the removal procedure.



2x
M2x3

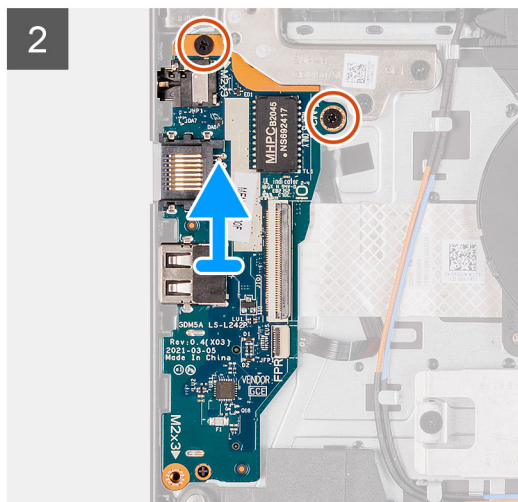
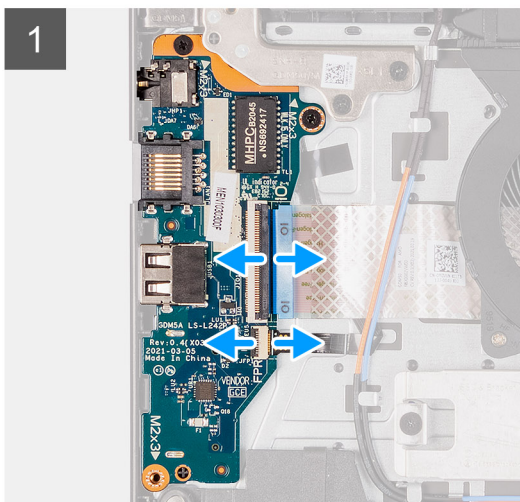
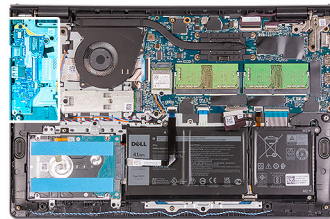

Steps

1. Open the latch and disconnect the fingerprint reader board cable from the I/O board.
2. Open the latch and disconnect the I/O board cable from the I/O board.
3. Remove the two (M2x3) screws that secure the I/O board to the palmrest and keyboard assembly.
4. Lift the I/O board off the palmrest and keyboard assembly.

Installing the Input/Output board

Prerequisites

If you are replacing a component, remove the existing component before performing the installation process.

About this task

The following images indicate the location of the I/O board and provides a visual representation of the installation procedure.



2x
M2x3

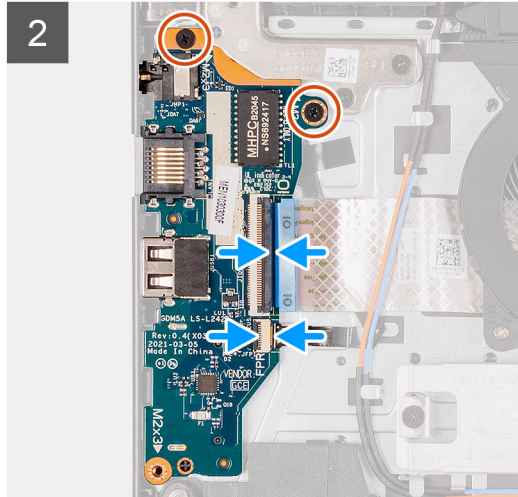
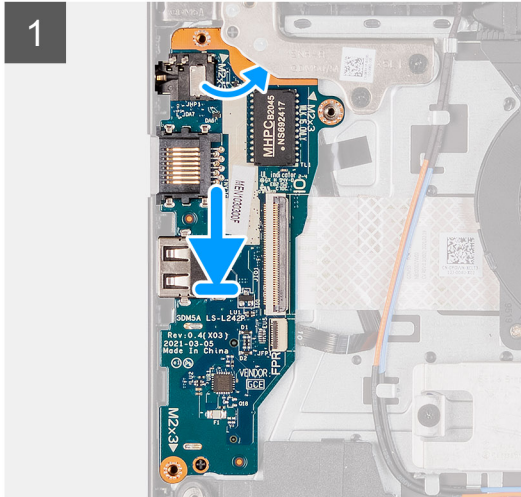
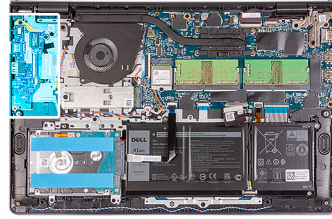

Steps

1. Place the I/O board on the palmrest and keyboard assembly.
2. Align the screw holes on the I/O board to the screw holes on the palmrest and keyboard assembly.
3. Replace the two screws (M2x3) that secure the I/O board to the palmrest and keyboard assembly.
4. Connect the fingerprint reader board cable to the connector on the I/O board and close the latch.
5. Connect the I/O board power cable to the connector on the I/O board and close the latch.

Next steps

1. Install the [base cover](#).
2. Reconnect the [SD card](#).
3. Follow the procedure in [After working inside your computer](#).

Hard drive assembly

Removing the hard drive assembly

Prerequisites

1. Follow the procedure in [Before working inside your computer](#).
2. Remove the [SD card](#).
3. Remove the [base cover](#).

About this task

The following images indicate the location of the hard drive assembly and provides a visual representation of the removal procedure.

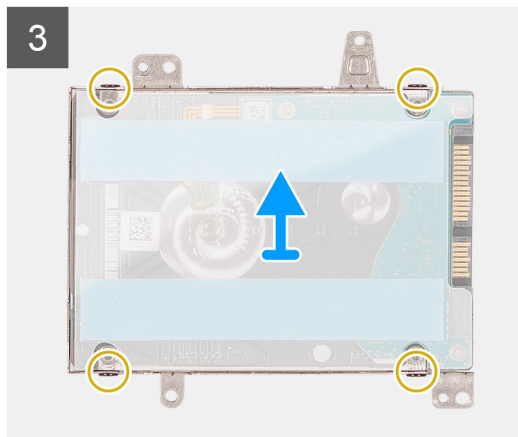
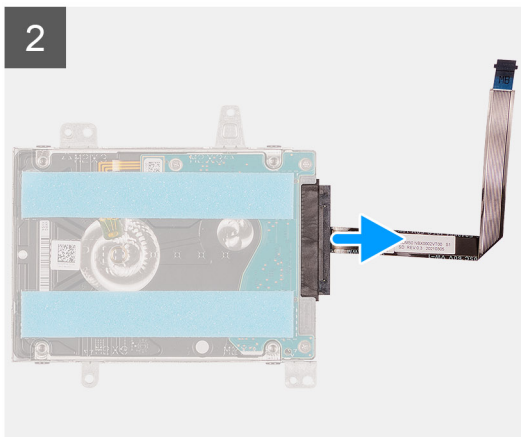
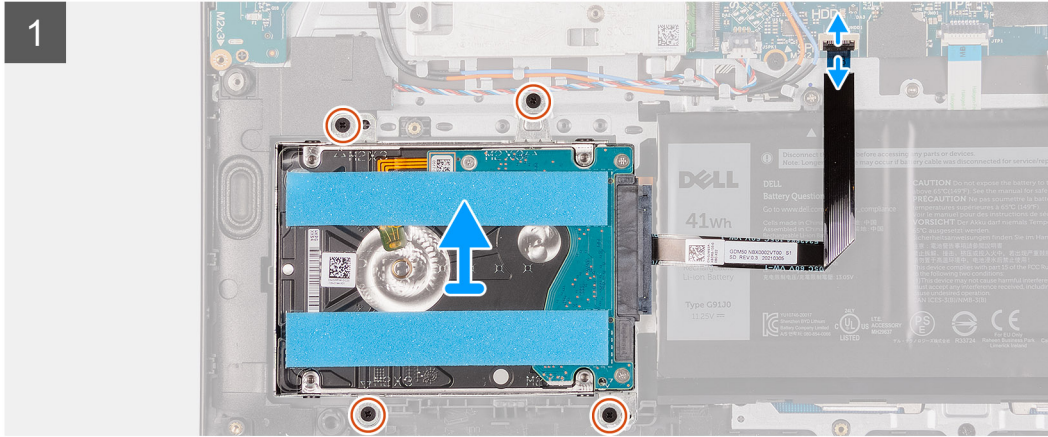
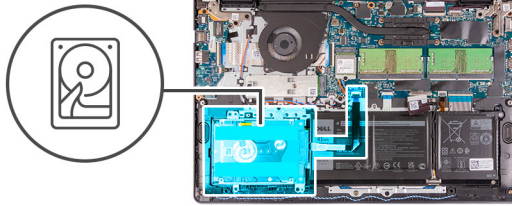

Steps

1. Disconnect the hard drive cable from the system board.
2. Remove the four screws (M2x3) that secure the hard drive assembly to the palmrest and keyboard assembly.
3. Lift the hard drive assembly and its cable from the palmrest and keyboard assembly.
4. Disconnect the hard drive cable from the hard drive.
5. Remove the four screws (M3x3) that secure the hard drive to the hard drive bracket.
6. Slide and remove the hard drive from the hard drive bracket.

Installing the hard drive assembly

Prerequisites

If you are replacing a component, remove the existing component before performing the installation process.

About this task

The following images indicate the location of the hard drive assembly and provides a visual representation of the installation procedure.

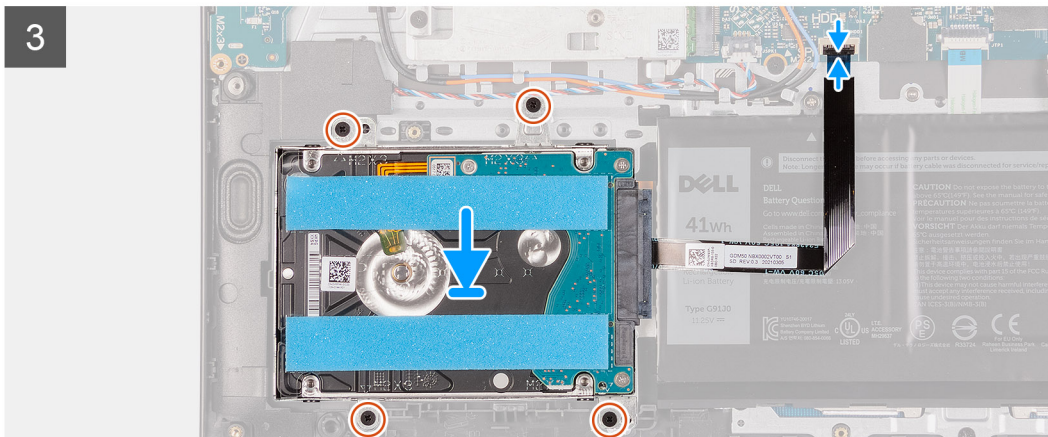
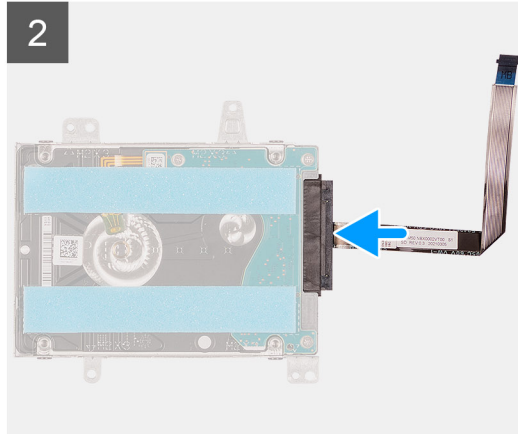
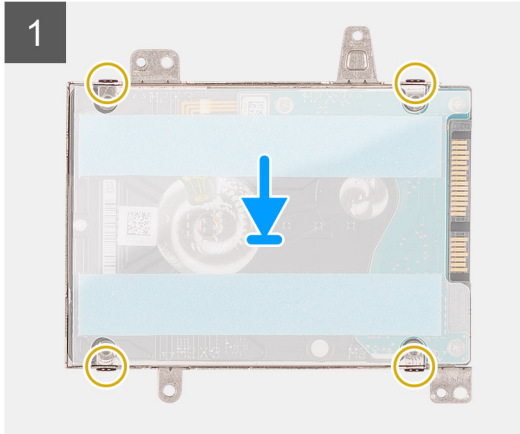
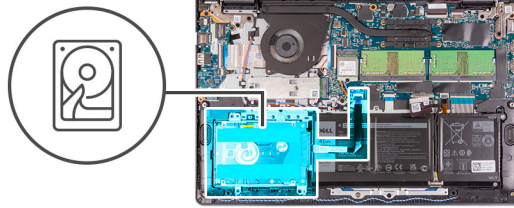

Steps

1. Place and slide the hard drive into the hard-drive bracket.
2. Align the screw holes on the hard drive bracket with the screw holes on the hard drive.
3. Replace the four screws (M3x3) that secure the hard drive to the hard drive bracket.
4. Connect the hard drive cable to the hard drive.
5. Place the hard drive assembly on the palmrest and keyboard assembly.
6. Align the screw holes on the hard drive assembly to the screw holes on the palmrest and keyboard assembly.
7. Replace the four screws (M2x3) that secure the hard drive assembly to the palmrest and keyboard assembly.
8. Connect the hard drive cable to the connector on the system board.

Next steps

1. Install the [base cover](#).
2. Install the [SD card](#).
3. Follow the procedure in [After working inside your computer](#).

Memory modules

Removing the memory modules

Prerequisites

1. Follow the procedure in [Before working inside your computer](#).
2. Remove the [SD card](#).
3. Remove the [base cover](#).

About this task

The following images indicate the location of the memory modules and provides a visual representation of the removal procedure.

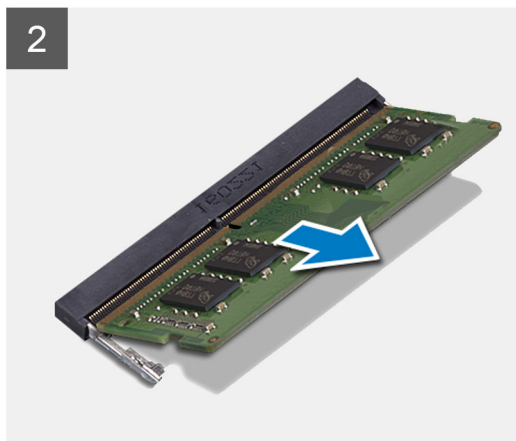
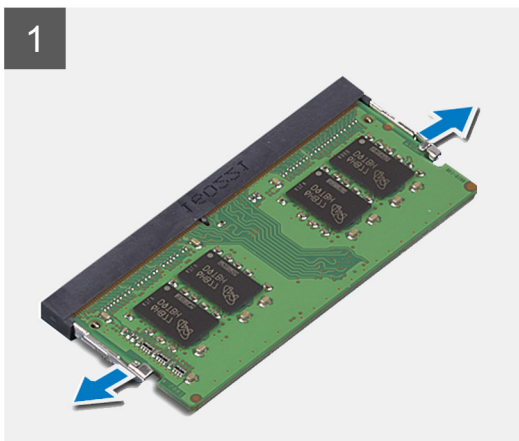
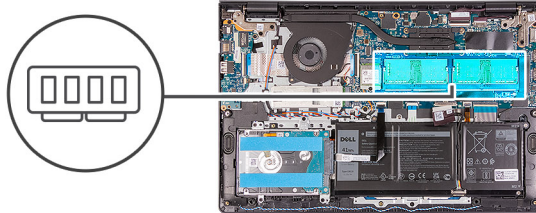

Steps

1. Gently pry the securing-clips on each end of the memory-module slot until the memory module pops up.
2. Lift at an angle and remove the memory module from its slot on the system board.
3. Repeat the above procedure for the second memory module.

Installing the memory modules

Prerequisites

If you are replacing a component, remove the existing component before performing the installation process.

About this task

The following images indicate the location of the memory modules and provides a visual representation of the installation procedure.

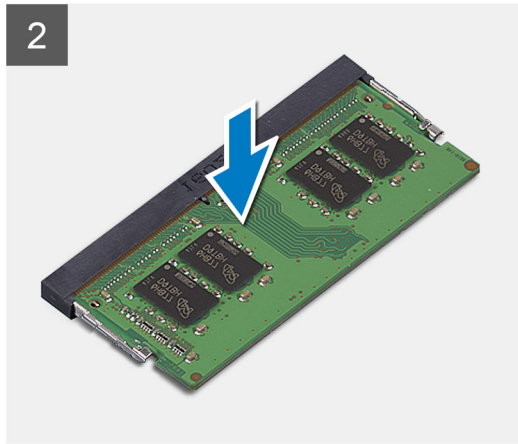
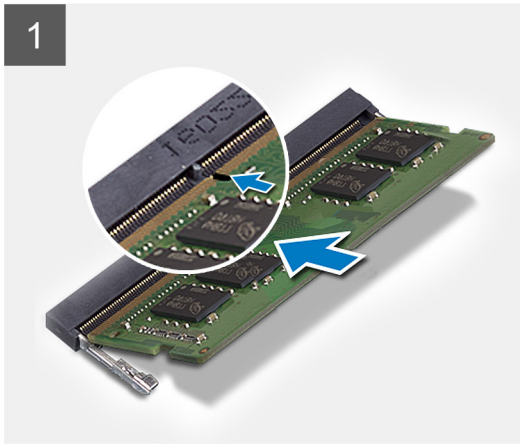
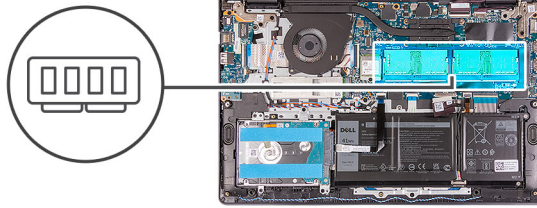

Steps

1. Align the slot on the memory module with the notch on the memory module slot on the system board.
2. Slide the memory module into the slot on the system board.
3. Press down on the memory module to snap it into place.
4. Ensure that the securing clips have locked the memory module into place.
 - NOTE:** If the securing clips do not lock the memory module into place remove the memory module from the slot and repeat steps 1 to 3.
5. Repeat the above procedure for the second memory module.

Next steps

1. Install the [base cover](#).
2. Install the [SD card](#).
3. Follow the procedure in [After working inside your computer](#).

Speakers

Removing the speakers

Prerequisites

1. Follow the procedure in [Before working inside your computer](#).
2. Remove the [SD card](#).
3. Remove the [base cover](#).

About this task

The following images indicate the location of the speakers and provides a visual representation of the removal procedure.

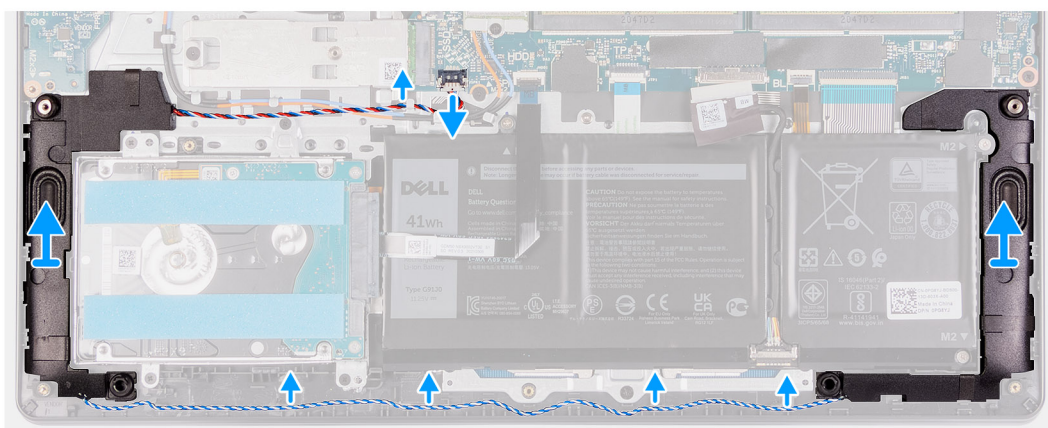
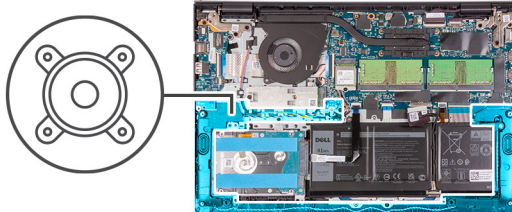

Steps

1. Disconnect the speaker cable from the system board.
2. Unroute the speaker cable from the routing guides on the palmrest and keyboard assembly.
3. Lift the speakers along with its cable from the palmrest and keyboard assembly.

Installing the speakers

Prerequisites

If you are replacing a component, remove the existing component before performing the installation process.

About this task

The following images indicate the location of the speakers and provides a visual representation of the installation procedure.

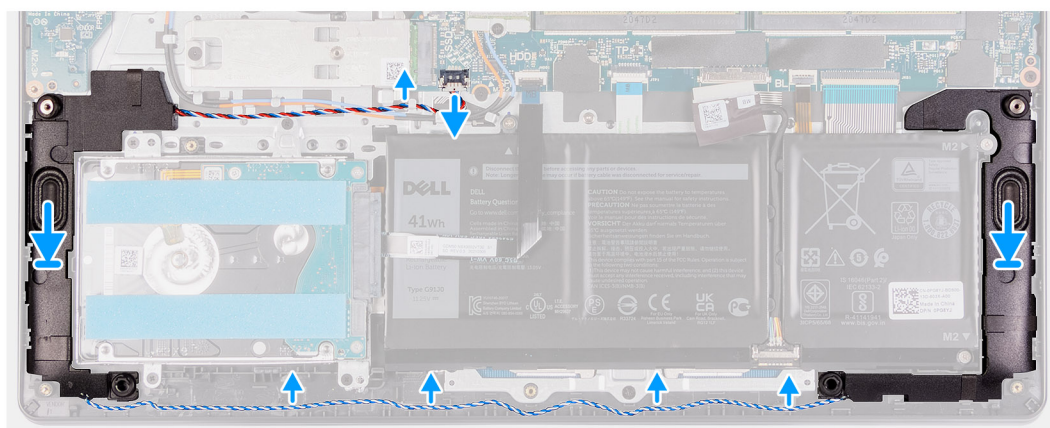
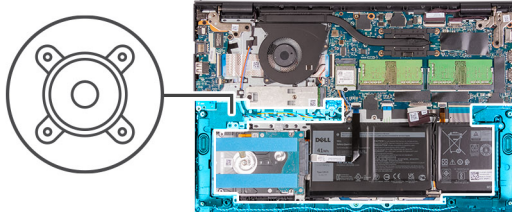

Steps

1. Using the alignment posts, place the speakers on the palmrest and keyboard assembly.
 - i** **NOTE:** Ensure that the alignment posts are threaded through the rubber grommets on the speaker.
2. Route the speaker cable through the routing guides on the palmrest and keyboard assembly.
3. Connect the speaker cable to the system board.

Next steps

1. Install the [base cover](#).
2. Install the [SD card](#).
3. Follow the procedure in [After working inside your computer](#).

Heat sink

Removing the heat sink

Prerequisites

1. Follow the procedure in [Before working inside your computer](#).
2. Remove the [SD card](#).
3. Remove the [base cover](#).

About this task

i **NOTE:** The heat sink may become hot during normal operation. Allow sufficient time for the heat sink to cool before you touch it.

i **NOTE:** For maximum cooling of the processor, do not touch the heat transfer areas on the heat sink. The oils in your skin can reduce the heat transfer capability of the thermal grease.

The following images indicate the location of the heat sink and provides a visual representation of the removal procedure.

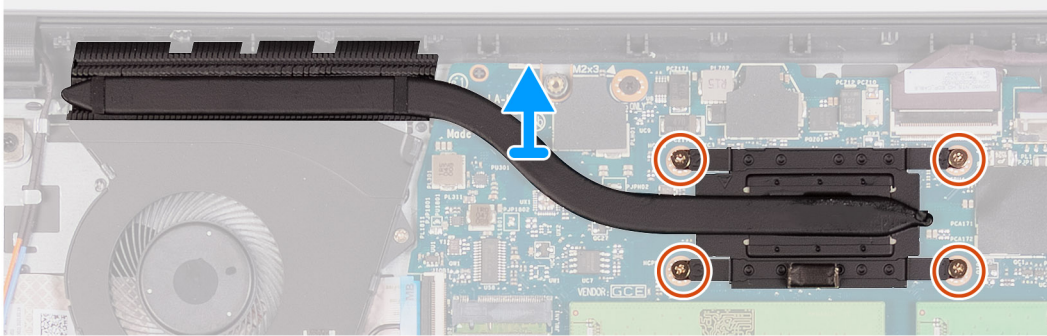
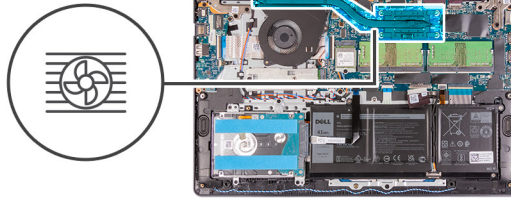

Steps

1. Loosen the four captive screws that secure the heat sink to the system board.
i **NOTE:** Loosen the captive screws in the reverse sequential order mentioned on the heat sink [4 > 3 > 2 > 1].
2. Lift the heat sink from the system board.

Installing the heat sink

Prerequisites

If you are replacing a component, remove the existing component before performing the installation process.

About this task

i **NOTE:** If either the system board or the heat sink is replaced, use the thermal grease provided in the kit to ensure that thermal conductivity is achieved.

The following images indicate the location of the heat sink and provides a visual representation of the installation procedure.

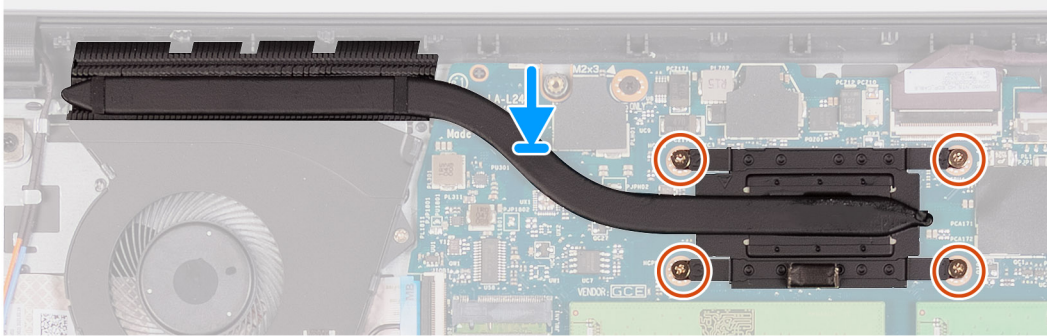
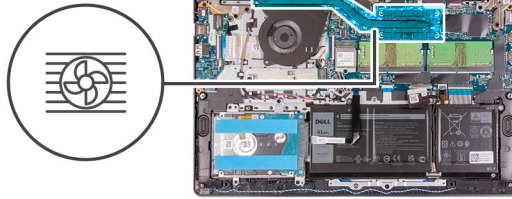

Steps

1. Place the heat sink on the system board.
2. Tighten the four captive screws that secure the heat sink to the system board.

 **NOTE:** Tighten the captive screws in the sequential order mentioned on the heat sink [1 > 2 > 3 > 4].

Next steps

1. Install the [base cover](#).
2. Install the [SD card](#).
3. Follow the procedure in [After working inside your computer](#).

Fan

Removing the fan

Prerequisites

1. Follow the procedure in [Before working inside your computer](#).
2. Remove the [SD card](#).
3. Remove the [base cover](#).

About this task

The following images indicate the location of the fan and provides a visual representation of the removal procedure.



2x
M2x5

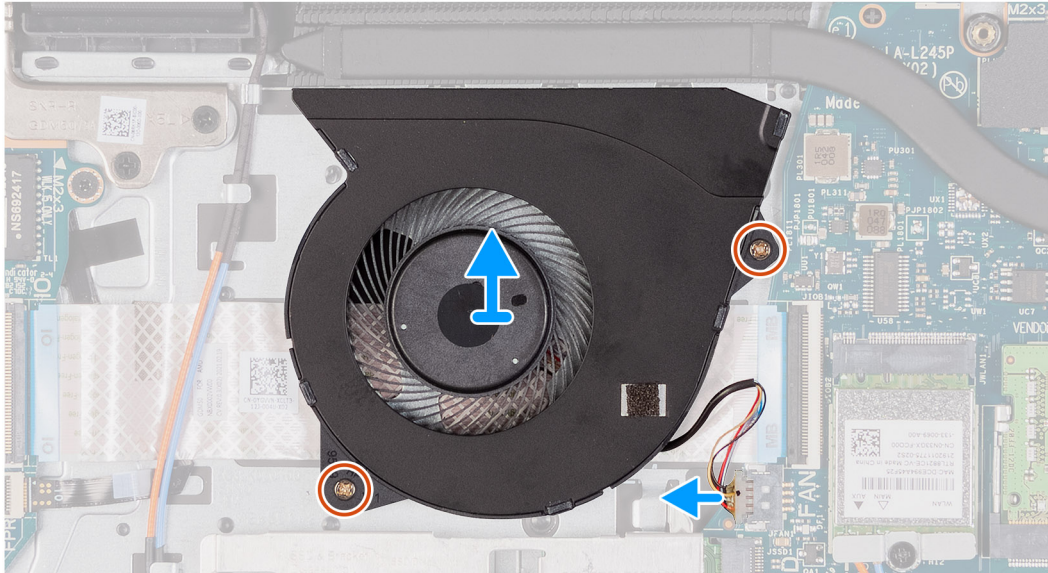
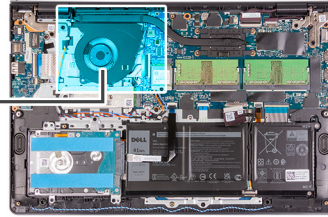
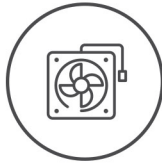

Steps

1. Disconnect the fan cable from the system board.
2. Remove the two screws (M2x5) that secure the fan to the palmrest and keyboard assembly.
3. Lift the fan from the palmrest and keyboard assembly.

Installing the fan

Prerequisites

If you are replacing a component, remove the existing component before performing the installation process.

About this task

The following images indicate the location of the fan and provides a visual representation of the installation procedure.



2x
M2x5

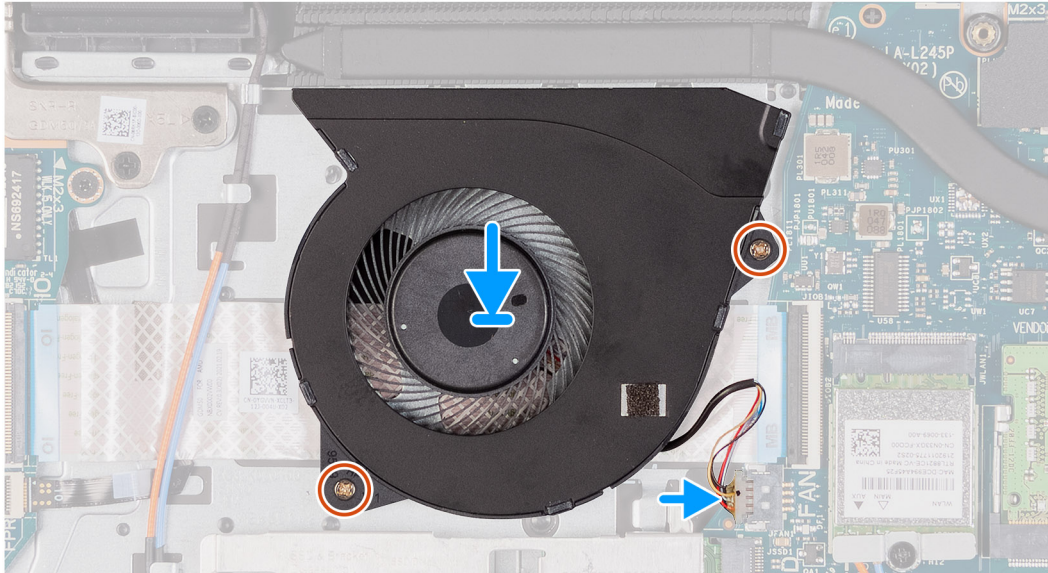
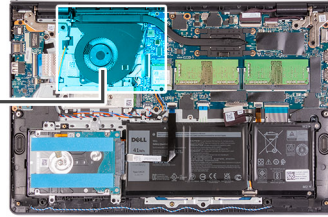
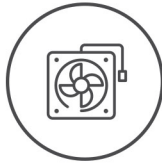

Steps

1. Place the fan on the palmrest and keyboard assembly.
2. Connect the fan cable to the connector on the system board.
3. Align the screw holes on the fan to the screw holes on the palmrest and keyboard assembly.
4. Replace the two screws (M2x5) that secure the fan to the palmrest and keyboard assembly.

Next steps

1. Install the [base cover](#).
2. Install the [SD card](#).
3. Follow the procedure in [After working inside your computer](#).

Power button

Removing the power button

Prerequisites

1. Follow the procedure in [before working inside your computer](#).
2. Remove the [SD card](#).
3. Remove the [base cover](#).
4. Remove the [IO board](#).

About this task

The following images indicate the location of the power button and provides a visual representation of the removal procedure.



1x
M2x2

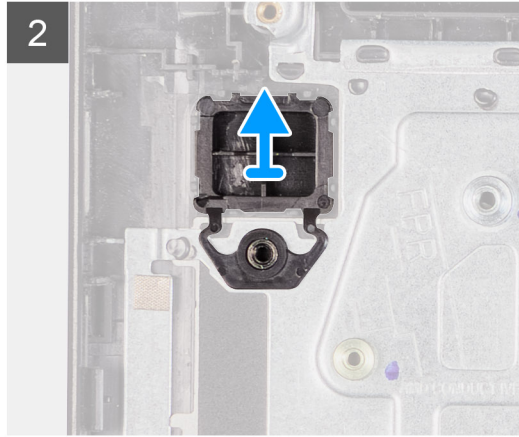
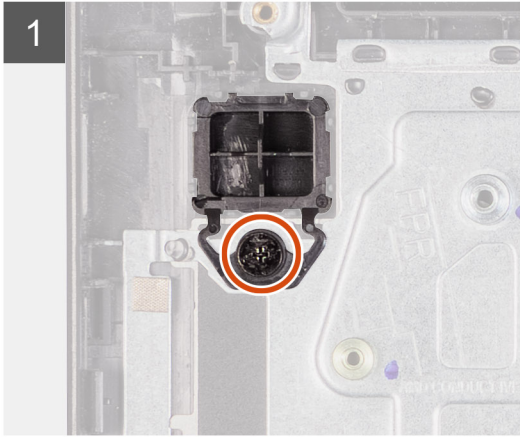
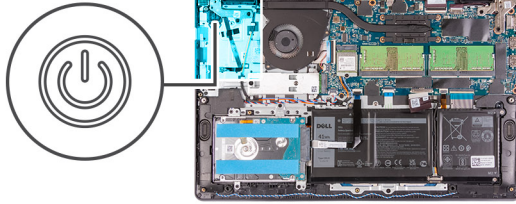

Steps

1. Remove the two (M2.5x5) screws that secure the display assembly hinge to the palmrest and keyboard assembly.
2. Lift the display assembly hinge to access the power button.
3. Remove the single (M2x2) screws securing the power button to the palm-rest and keyboard assembly.
4. Remove the power button from the computer.

Installing the power button

Prerequisites

If you are replacing a component, remove the existing component before performing the installation procedure.

About this task

The following images indicate the location of the power button and provides a visual representation of the installation procedure.



1x
M2x2

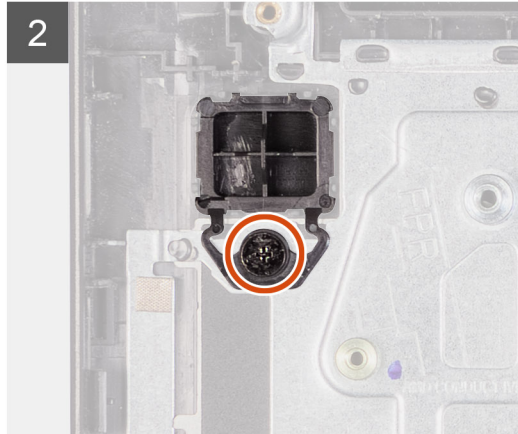
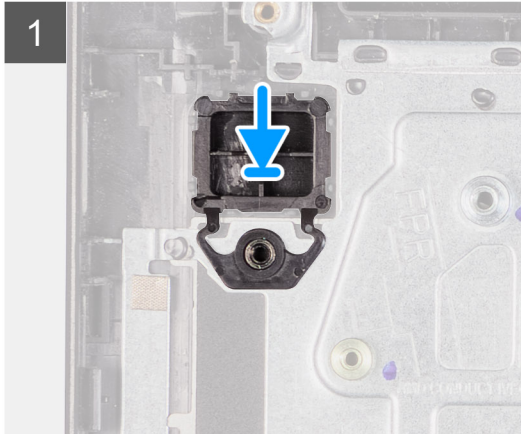
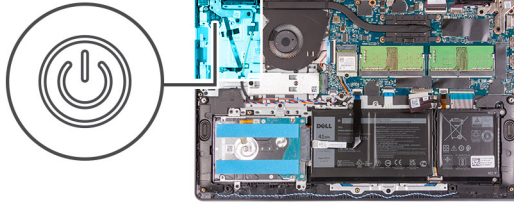

Steps

1. Place the power-button board into the slot on the palm-rest and keyboard assembly.
2. Install the single (M2x2) screws to secure the power button to the palm-rest and keyboard assembly.
3. Close the display hinge.
4. Replace the two (M2.5x5) screws that secure the display hinge to the palmrest and keyboard assembly.

Next steps

1. Install the [IO board](#).
2. Install the [base cover](#).
3. Install the [SD card](#).
4. Follow the procedure in [after working inside your computer](#).

Power-button with optional fingerprint reader

Removing the power button with optional fingerprint reader

Prerequisites

1. Follow the procedure in [Before working inside your computer](#).
2. Remove the [SD card](#).
3. Remove the [base cover](#).
4. Remove the [I/O board](#).

About this task

The following images indicate the location of the power button with optional fingerprint reader and provides a visual representation of the removal procedure.

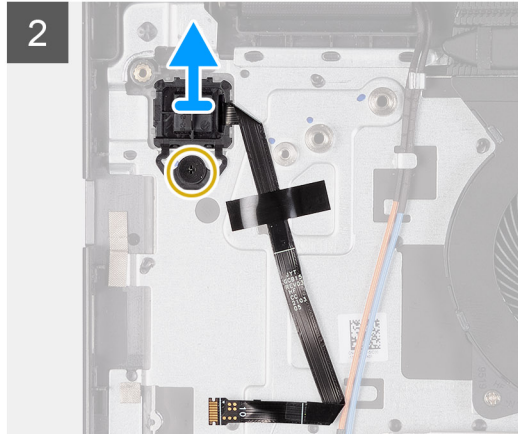
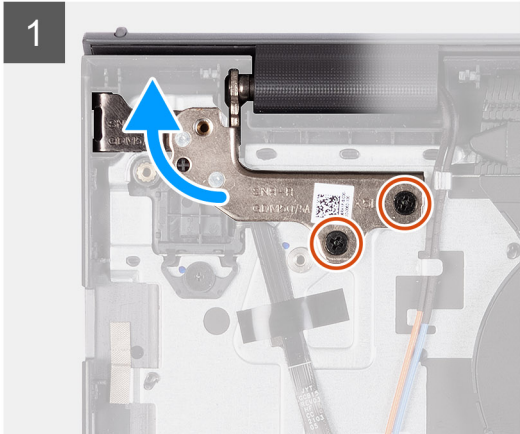
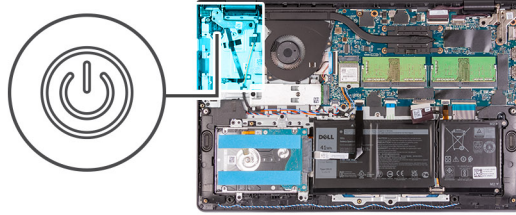

Steps

1. Remove the two (M2.5x5) screws that secure the display assembly hinge to the palmrest and keyboard assembly.
2. Lift the display assembly hinge to access the power button.
3. Remove the (M2x2) screw that secures the power button to the palmrest and keyboard assembly.
4. Peel the fingerprint reader Flexible Flat cable from the palmrest and keyboard assembly.
5. Lift the power button with fingerprint reader, along with its cable, off the palmrest and keyboard assembly.

Installing the power button with optional fingerprint reader

Prerequisites

If you are replacing a component, remove the existing component before performing the installation process.

About this task

The following images indicate the location of the power button with optional fingerprint reader and provides a visual representation of the installation procedure.

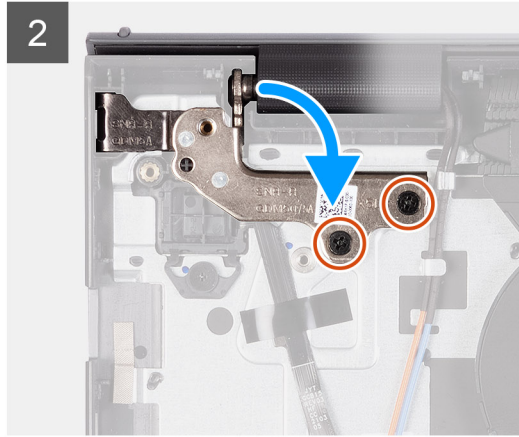
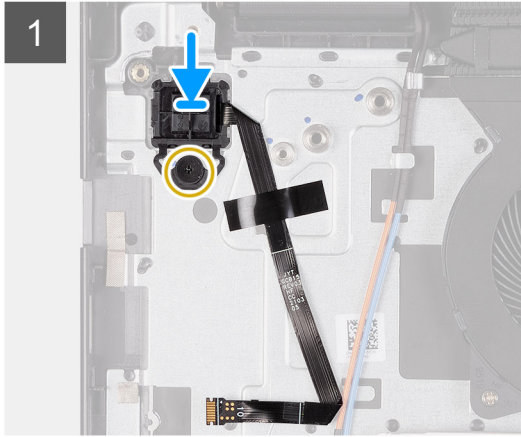
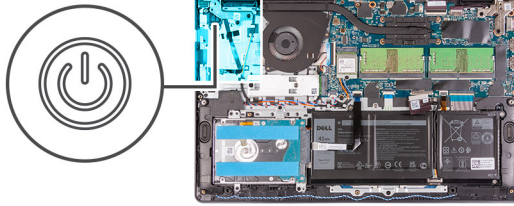

Steps

1. Using the alignment posts, place the power button with fingerprint reader into its slot on the palmrest and keyboard assembly.
2. Replace the (M2x2) screw that secures the power button with fingerprint reader to the palmrest and keyboard assembly.
3. Adhere the fingerprint reader Flexible Flat cable to the palmrest and keyboard assembly
i **NOTE:** Fold and align the fingerprint reader Flexible Flat cable to the mark at the right of the power button, and align the white line on the Flexible Flat cable to the mark on the palmrest and keyboard assembly.
4. Close the display hinge.
5. Replace the two (M2.5x5) screws that secure the display hinge to the palmrest and keyboard assembly.

Next steps

1. Install the [I/O board](#).
2. Install the [base cover](#).
3. Install the [SD card](#).
4. Follow the procedure in [After working inside your computer](#).

Display assembly

Removing the display assembly

Prerequisites

1. Follow the procedure in [Before working inside your computer](#).
2. Remove the [SD card](#).
3. Remove the [base cover](#).
4. Remove the [Wireless card](#).

About this task

The following images indicate the location of the display assembly and provides a visual representation of the removal procedure.



4x
M2.5x5

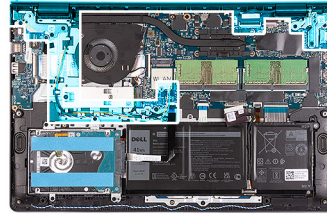

1

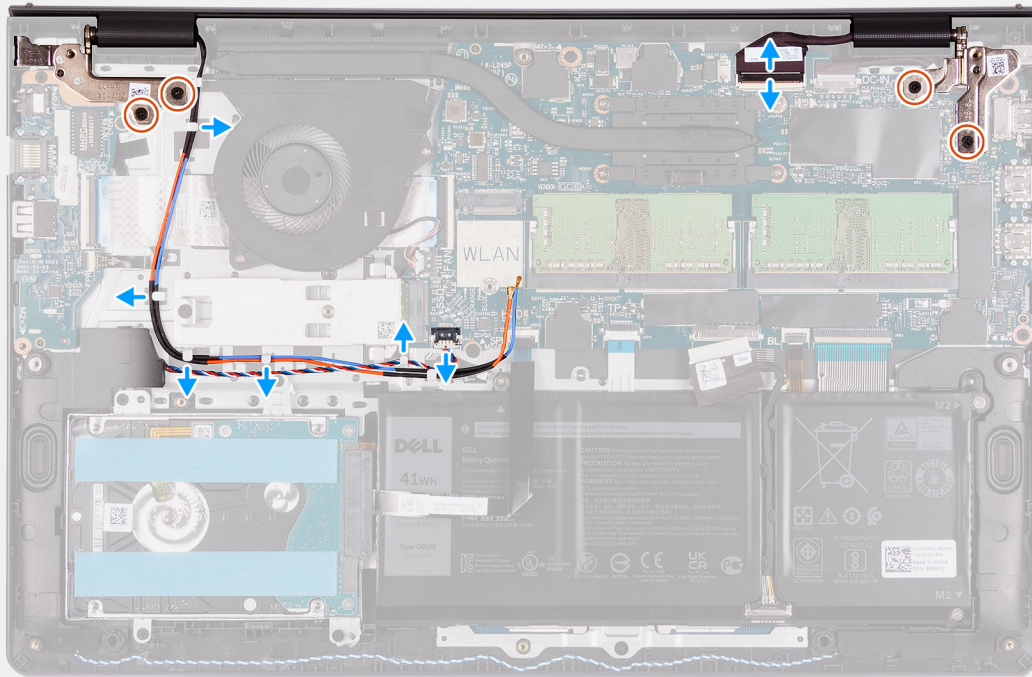

2

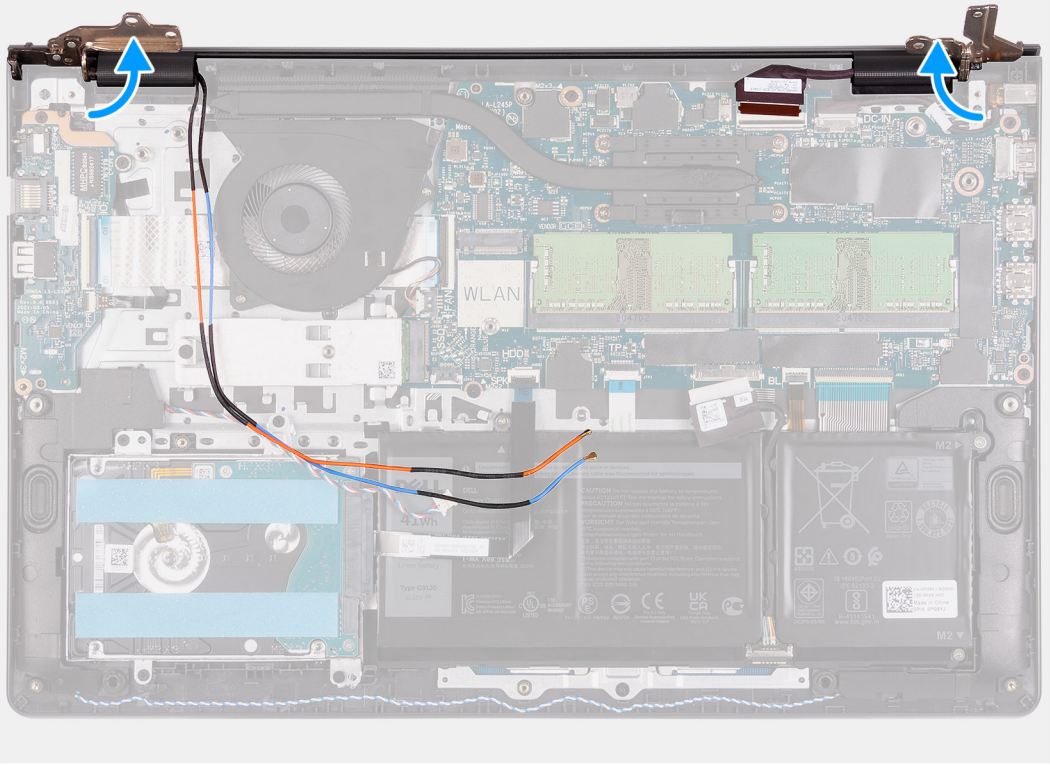

3





Steps

1. Disconnect the display cable from the connector on the system board.
2. Unroute the WLAN antenna cables and the speaker cables from the routing guides on the computer.
3. Remove the four(M2.5x5) screws that secure the display hinges to the palm-rest and keyboard assembly.
4. Fold the left and right hinges away from the palm-rest and keyboard assembly.
5. Lift the palm-rest and keyboard assembly at an angle to free it from the hinges and remove it from the display assembly.

Installing the display assembly

Prerequisites

If you are replacing a component, remove the existing component before performing the installation process.

About this task

The following images indicate the location of the display assembly and provides a visual representation of the installation procedure.



4x
M2.5x5

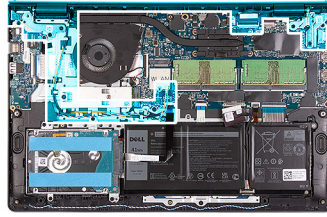

1

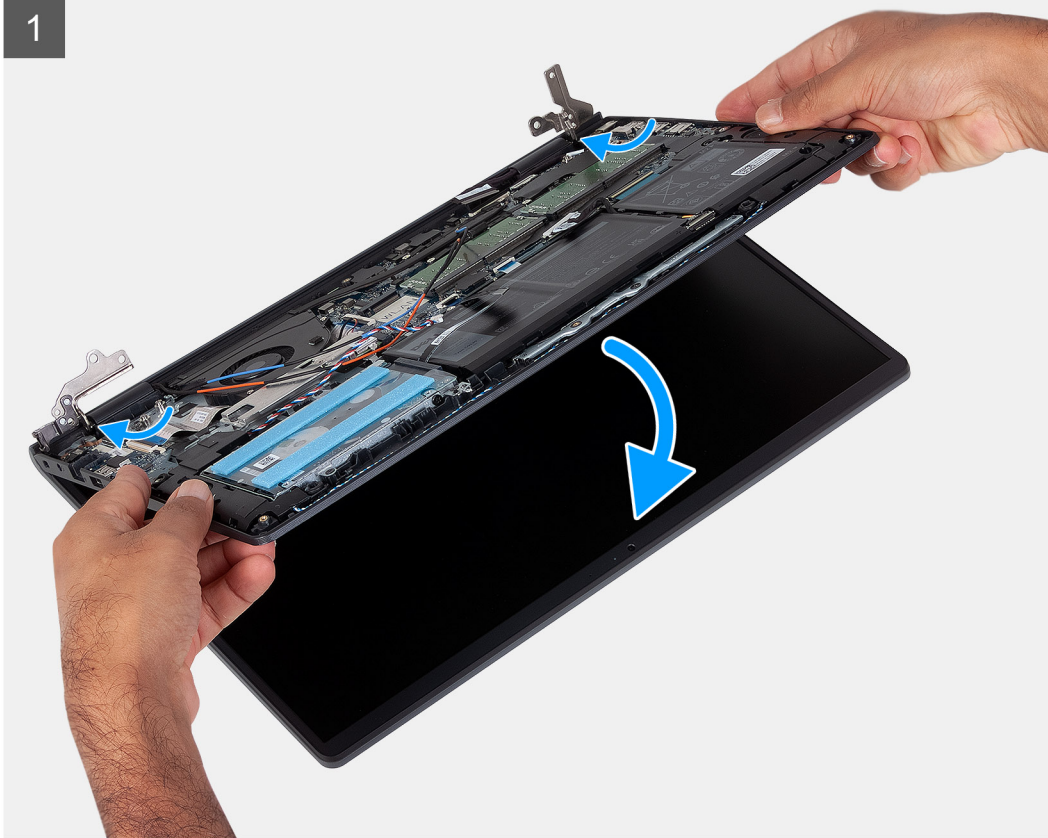

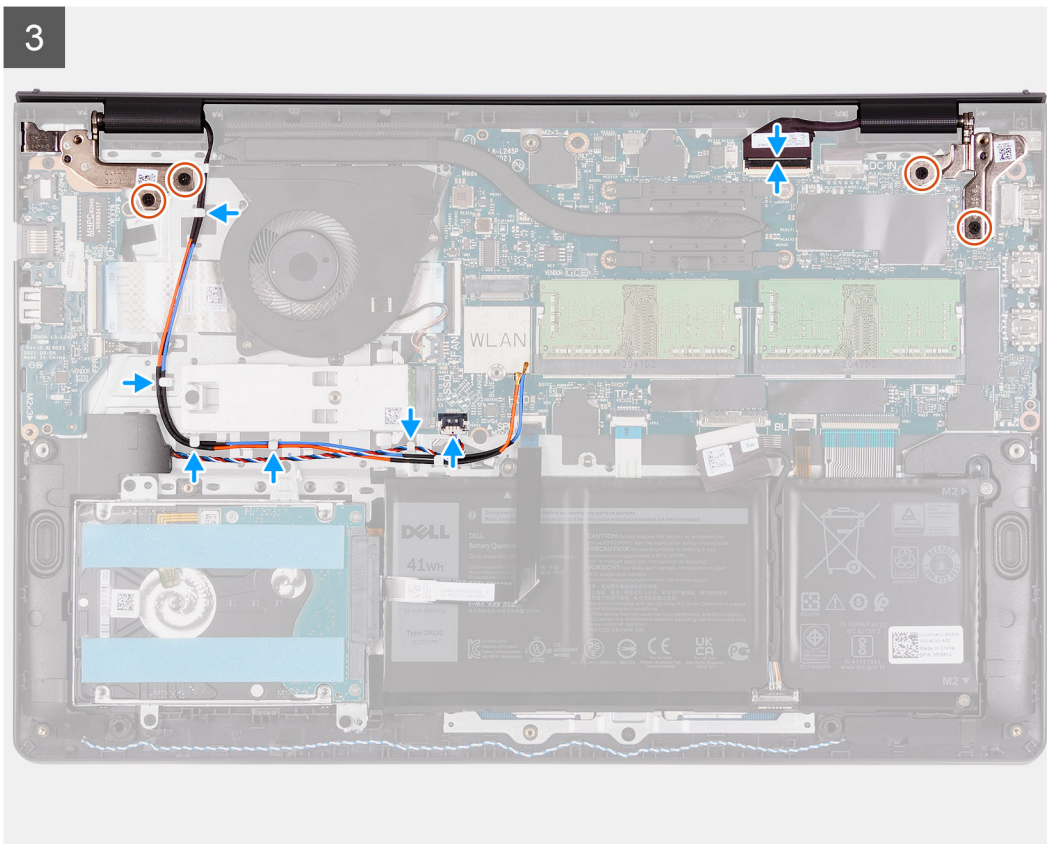
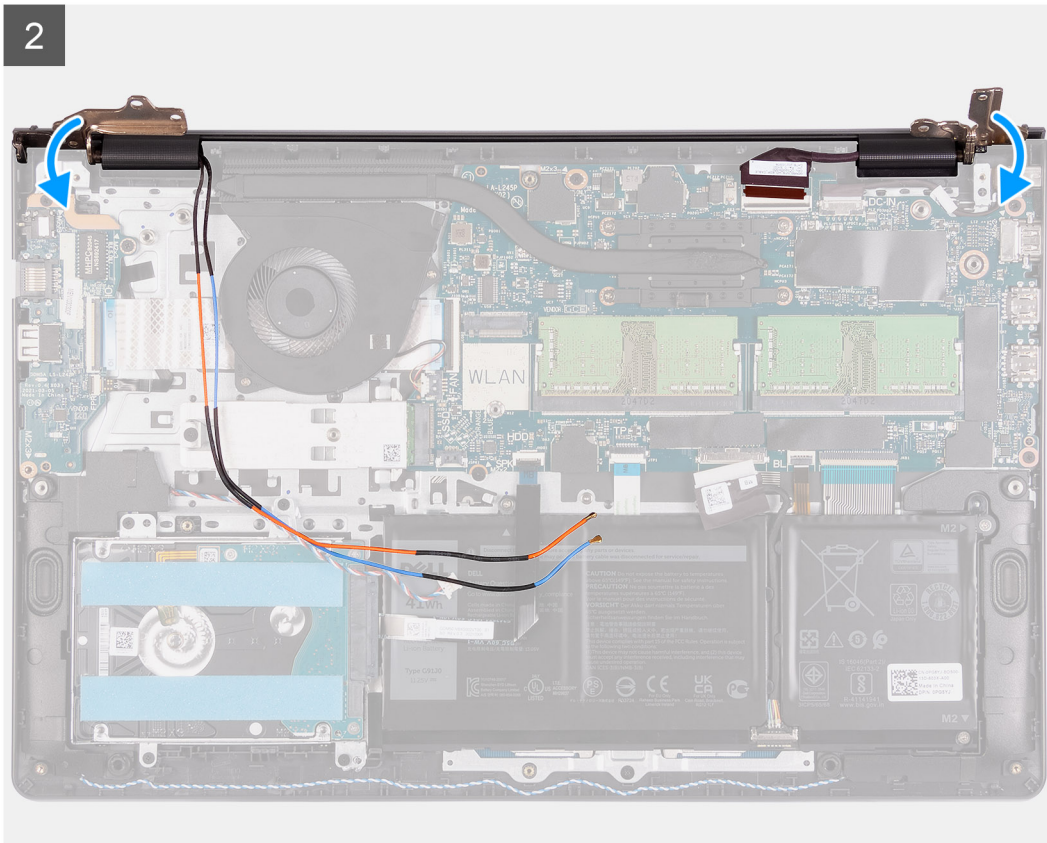

Steps

1. Align and place the system under the hinges on the display assembly.
2. Fold the hinges back and install the four (M2.5x5) screws to secure the display assembly.

3. Re-route the speaker and WLAN antenna cables through the routing channels on the palmrest.
4. Reconnect the display cable to the connector on the system board.

Next steps

1. Install the [Wireless card](#).
2. Install the [base cover](#).
3. Install the [SD card](#).
4. Follow the procedure in [After working inside your computer](#).

Hinge caps

Removing the hinge caps

Prerequisites

1. Follow the procedure in [Before working inside your computer](#).
2. Remove the [SD card](#).
3. Remove the [base cover](#).
4. Remove the [Wireless card](#).
5. Remove the [display assembly](#).

About this task

The following images indicate the location of the hinge caps and provides a visual representation of the installation procedure.

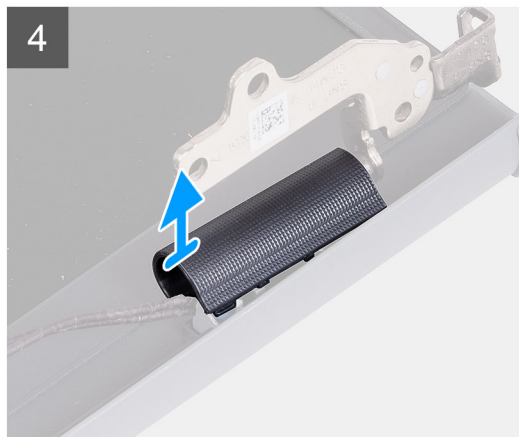
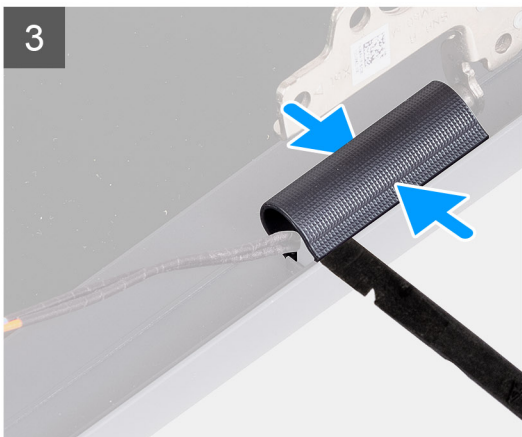
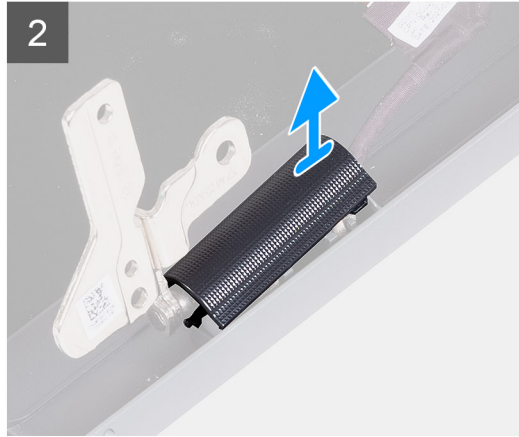
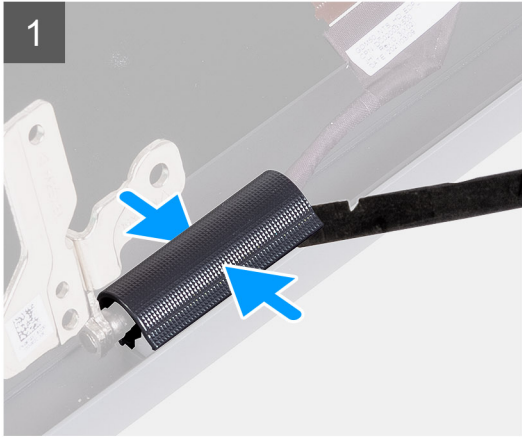
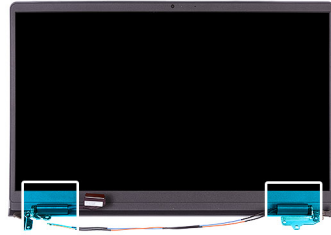

Steps

i **NOTE:** Before removing the display hinge caps, open the display hinges to 140 degrees.

1. Pinch the left hinge cap in the center.
2. Using a plastic scribe pry the inner side of the left hinge cap and remove it from the left hinge.
3. Pinch the right hinge cap in the center.
4. Using a plastic scribe pry the inner side of the right hinge cap and remove it from the right hinge.

Installing the hinge caps

Prerequisites

If you are replacing a component, remove the existing component before performing the installation procedure.

About this task

The following images indicate the location of the hinge caps and provides a visual representation of the installation procedure.

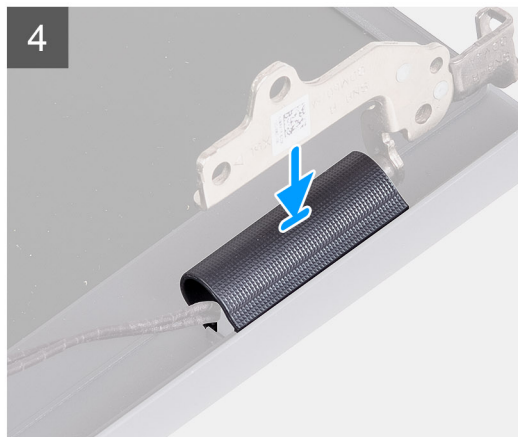
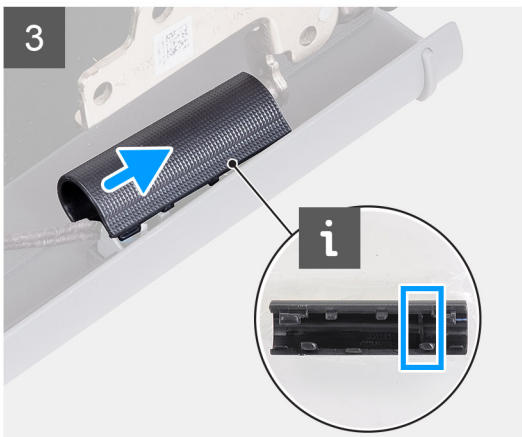
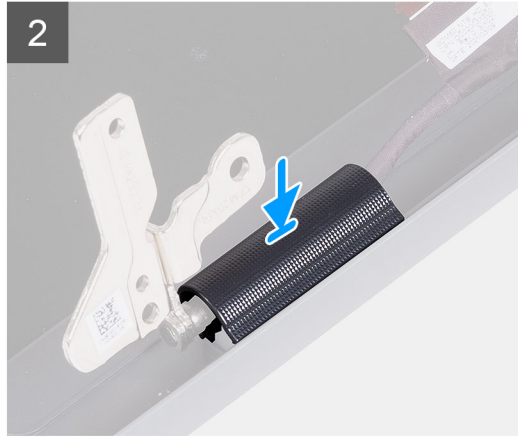
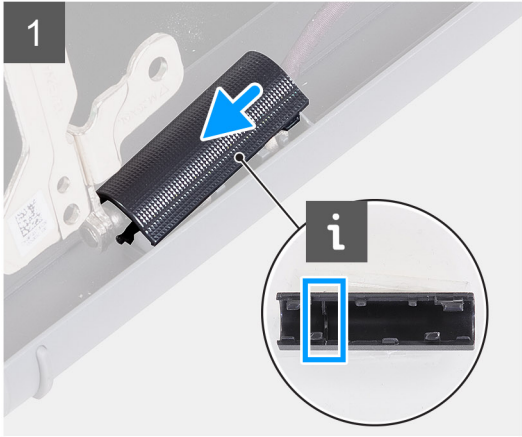
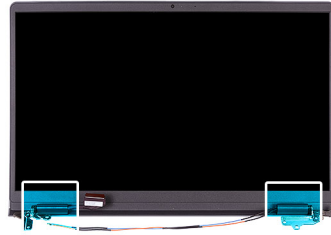

Steps

1. Align the rib inside the left hinge cap to the outer sides.
2. Push the left hinge cap down until it clicks in place.
3. Align the rib inside the right hinge cap to the outer sides.
4. Push the right hinge cap down until it clicks in place.

Next steps

1. Install the [display assembly](#).
2. Install the [Wireless card](#).
3. Install the [base cover](#).
4. Install the [SD card](#).
5. Follow the procedure in [After working inside your computer](#).

Display bezel

Removing the display bezel

Prerequisites

1. Follow the procedure in [Before working inside your computer](#).
2. Remove the [SD card](#).
3. Remove the [base cover](#).
4. Remove the [Wireless card](#).
5. Remove the [display assembly](#).
6. Remove the [hinge caps](#).

About this task

The following images indicate the location of the display bezel and provides a visual representation of the removal procedure.

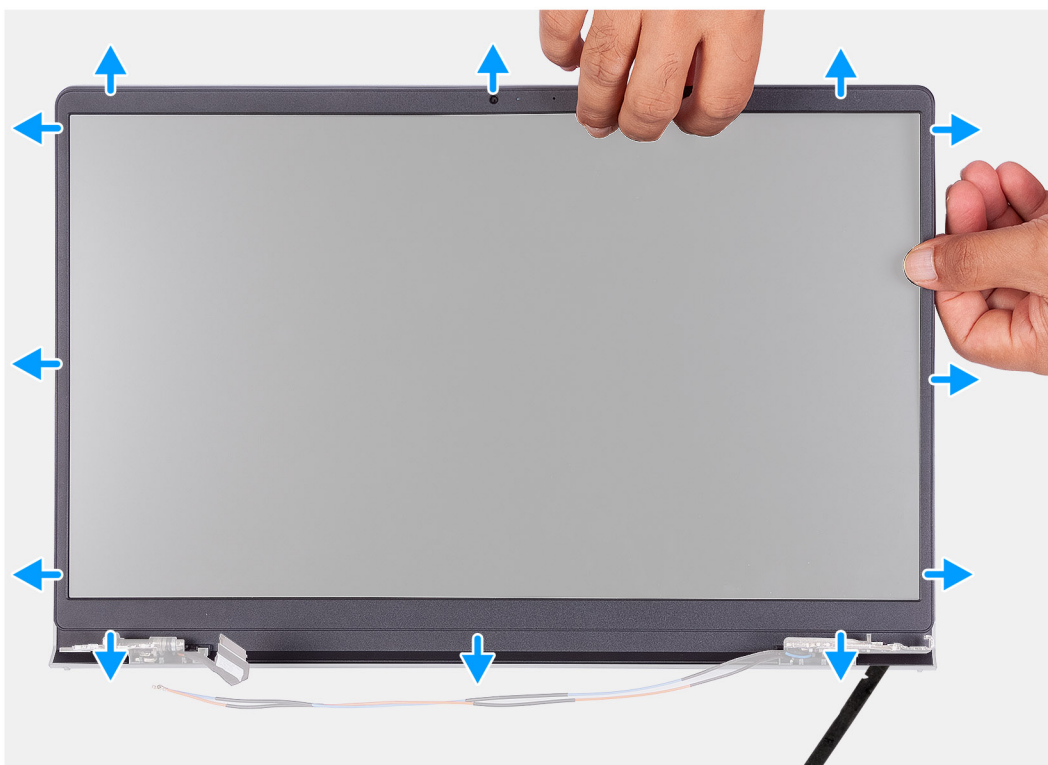

Steps

1. Use a plastic scribe to pry open the display bezel from the outer edge at the left and right sides of the display hinges.
i **NOTE:** The display bezel is adhered to the display panel with adhesive. Insert a plastic scribe into the recesses near both hinge caps to start the prying process to release the display bezel. Pry along the outside edge of the display bezel and work your way around the entire display bezel until the display bezel is separated from the display cover.

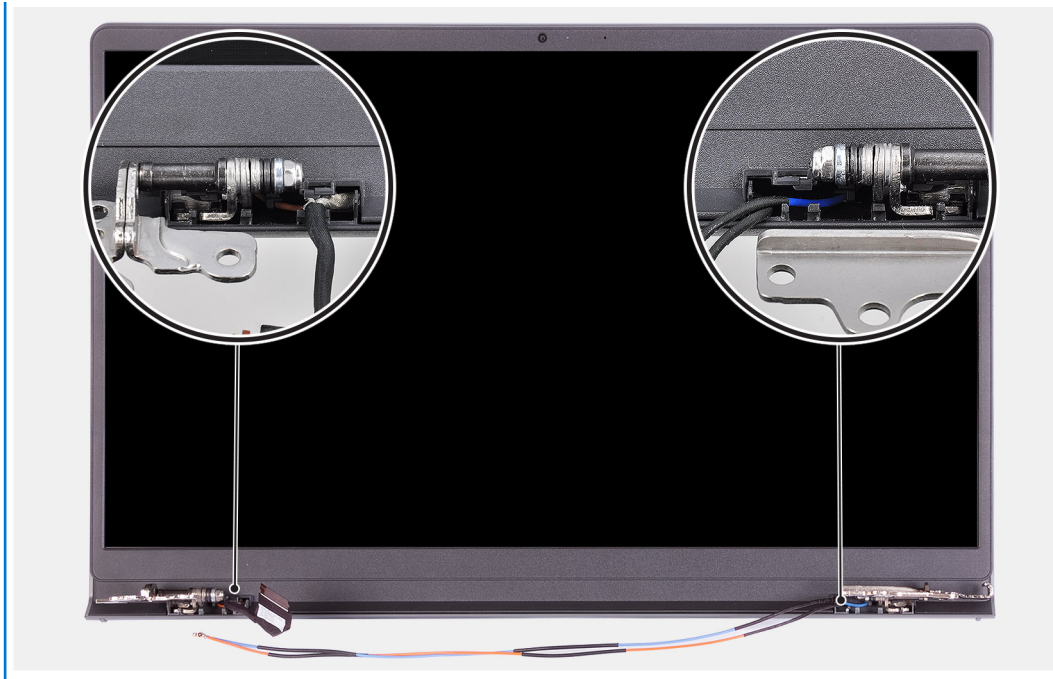

2. Carefully pry the bezel along the edges with your fingers.

NOTE: Do not use a scribe or any other objects, and apply pressure to the display panel to avoid damaging the display panel.

3. Work around the edge of the display assembly to pry the display bezel from the display assembly.
4. Lift and remove the display bezel from the display assembly.

Installing the display bezel

Prerequisites

If you are replacing a component, remove the existing component before performing the installation procedure.

About this task

The following images indicate the location of the display bezel and provides a visual representation of the installation procedure.

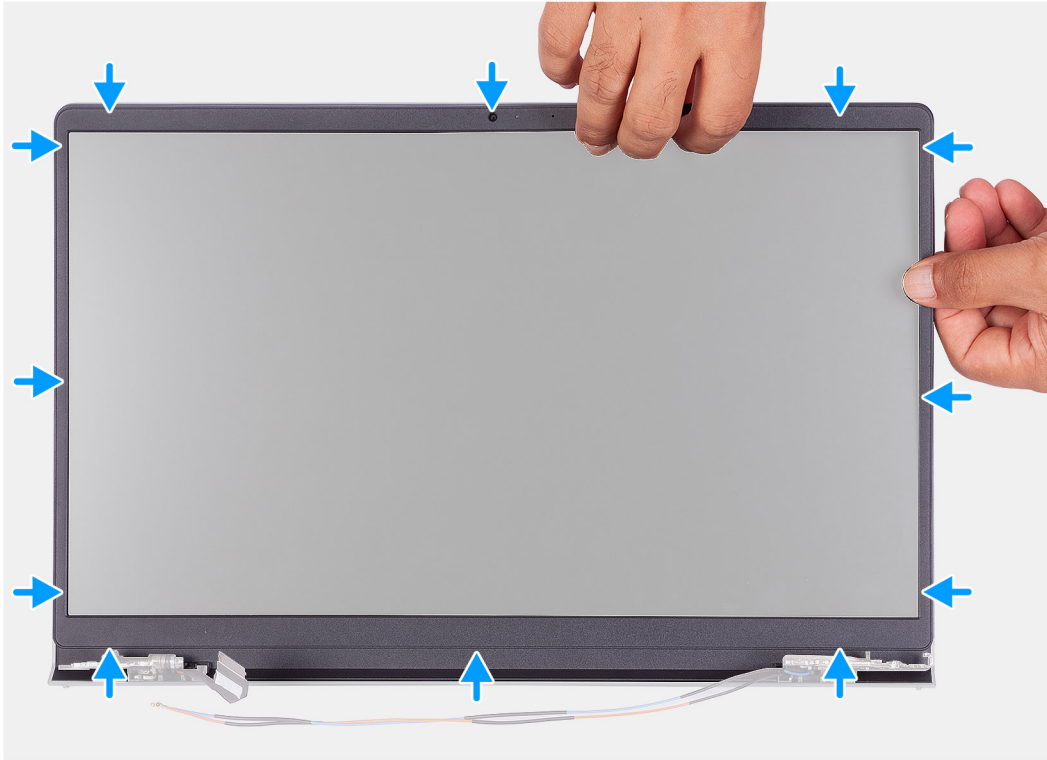

Steps

1. Place the display panel and display assembly on a clean and flat surface.
2. Place the display bezel on the display assembly.
3. Align the tabs on the display bezel to the slots on the display assembly.
4. Press down on the display bezel and snap the display bezel in place.

Next steps

1. Install the [hinge cap](#).
2. Install the [display assembly](#).
3. Install the [Wireless card](#).
4. Install the [base cover](#).
5. Install the [SD card](#).
6. Follow the procedure in [After working inside your computer](#).

Hinges

Removing the hinges

Prerequisites

1. Follow the procedure in [Before working inside your computer](#).

2. Remove the [SD card](#).
3. Remove the [base cover](#).
4. Remove the [WLAN card](#).
5. Remove the [display assembly](#).
6. Remove the [hinge caps](#).
7. Remove the [display bezel](#).

About this task

The following images indicate the location of the hinge caps and provides a visual representation of the installation procedure.



6x
M2.5x3.8

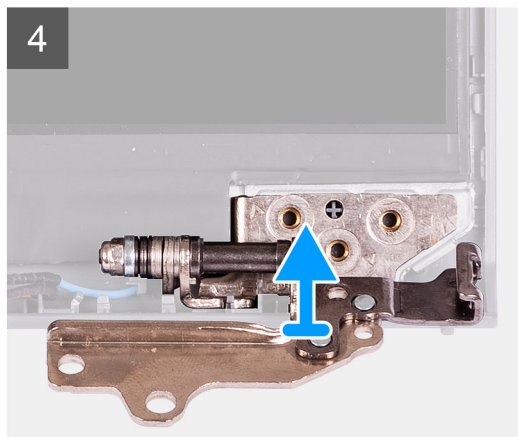
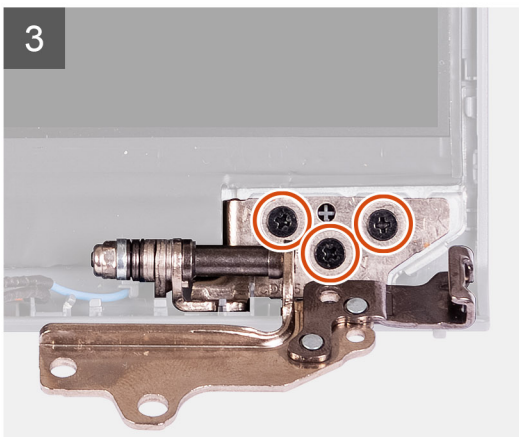
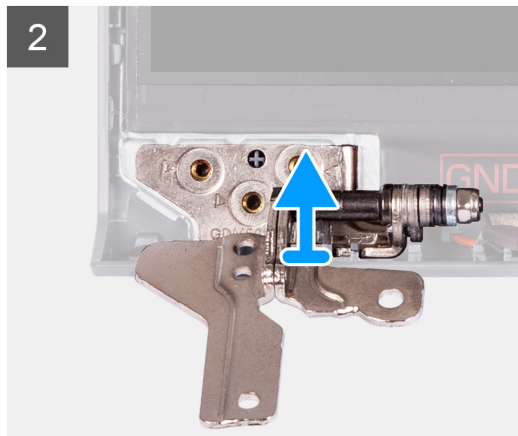

Steps

1. Remove the three (M2.5x3.8) from the left hinge.
2. Lift and remove the left hinge from the display assembly.
3. Remove the three (M2.5x3.8) from the right hinge.
4. Lift and remove the right hinge from the display assembly.

Installing the hinges

Prerequisites

If you are replacing a component, remove the existing component before performing the installation procedure.

About this task

The following images indicate the location of the hinges and provides a visual representation of the installation procedure.



6x
M2.5x3.8

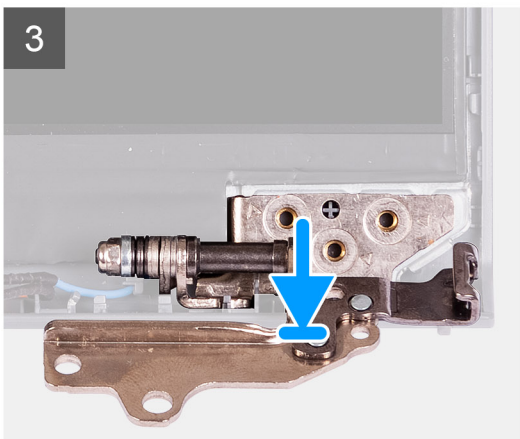
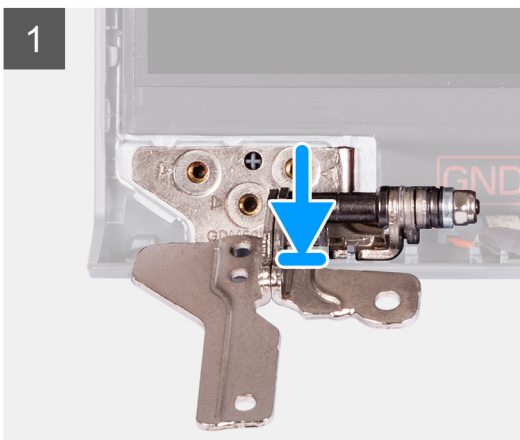

Steps

1. Align and place the left hinge on the display assembly.
2. Install the three (M2.5x3.8) screws to secure the hinge to the display panel and back cover.
3. Align and place the right hinge on the display assembly.
4. Install the three (M2.5x3.8) screws to secure the hinge to the display panel and back cover.

Next steps

1. Install the [display bezel](#).
2. Install the [hinge caps](#).
3. Install the [display assembly](#).

4. Install the [WLAN card](#).
5. Install the [base cover](#).
6. Install the [SD card](#).
7. Follow the procedure in [after working inside your computer](#).

Display panel

Removing the display panel

Prerequisites

1. Follow the procedure in [Before working inside your computer](#).
2. Remove the [SD card](#).
3. Remove the [base cover](#).
4. Remove the [wireless card](#).
5. Remove the [display assembly](#).
6. Remove the [display bezel](#).
7. Remove the [display hinge](#).

About this task

The following images indicate the location of the display panel and provides a visual representation of the removal procedure.

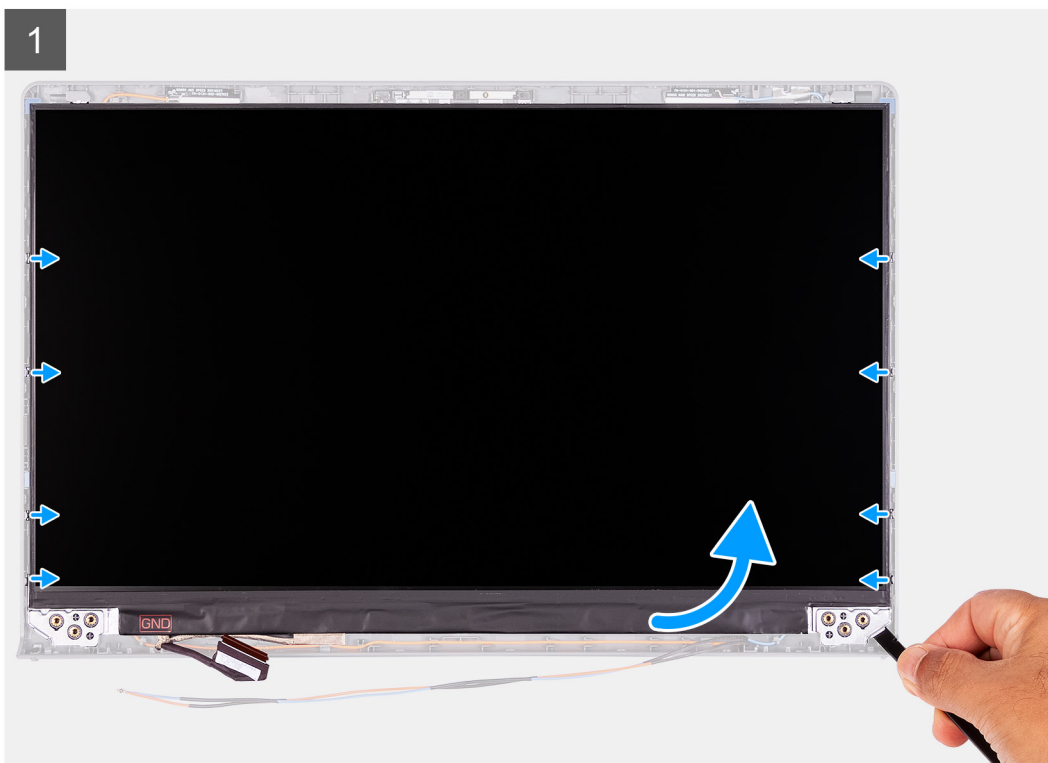
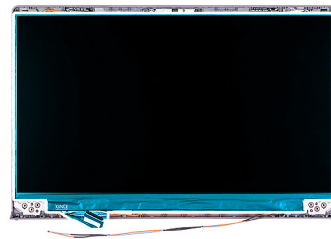



Steps

1. Use a plastic scribe to pry the display panel from the bottom-right corner.
2. Gently start prying the display panel along the left and right sides of the display back-cover using your hands.
3. Lift the bottom side of the display panel and slide it downward to release the display brackets from the slots at the top side of the display cover.
4. Gently flip the display panel assembly forward, peel back the Mylar tape securing the display cable on the rear of the display panel.

NOTE: Ensure that the panel has a clean and smooth surface to rest on to prevent damage.

5. Disconnect the display cable from the display panel assembly and lift the display panel away from the system.

NOTE: Do not remove the metal brackets from the panel.

Installing the display panel

Prerequisites

If you are replacing a component, remove the existing component before performing the installation process.

About this task

The following images indicate the location of the display panel and provides a visual representation of the installation procedure.

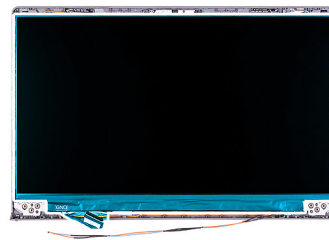

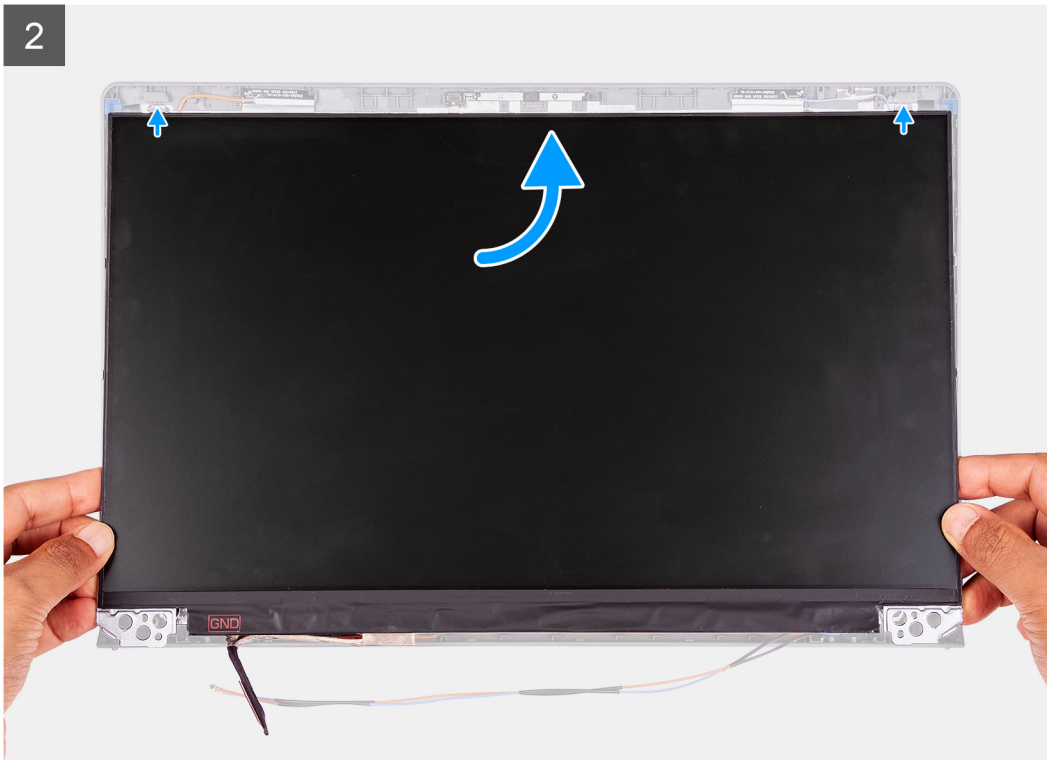

Steps

1. Place the display panel and display assembly on a clean and flat surface.
2. Connect the display cable to the connector on the display panel and close the latch.
3. Adhere the tape to secure the display-cable connector latch to the display panel.
4. Lift and rotate the display panel, then place the display panel on the display assembly.
5. Place the display bezel on the display assembly.
6. Align the tabs on the display bezel to the slots on the display assembly.

7. Press down on the display bezel and snap the display bezel in place.

Next steps

1. Install the [display hinge](#).
2. Install the [display bezel](#).
3. Install the [display assembly](#).
4. Install the [wireless card](#).
5. Install the [base cover](#).
6. Install the [SD card](#).
7. Follow the procedure in [After working inside your computer](#).

Camera module

Removing the camera module

Prerequisites

1. Follow the procedure in [Before working inside your computer](#).
2. Remove the [SD card](#).
3. Remove the [base cover](#).
4. Remove the [wireless card](#).
5. Remove the [display assembly](#).
6. Remove the [display bezel](#).
7. Remove the [display panel](#).
8. Remove the [display hinge](#).

About this task

The following images indicate the location of the camera module and provides a visual representation of the removal procedure.

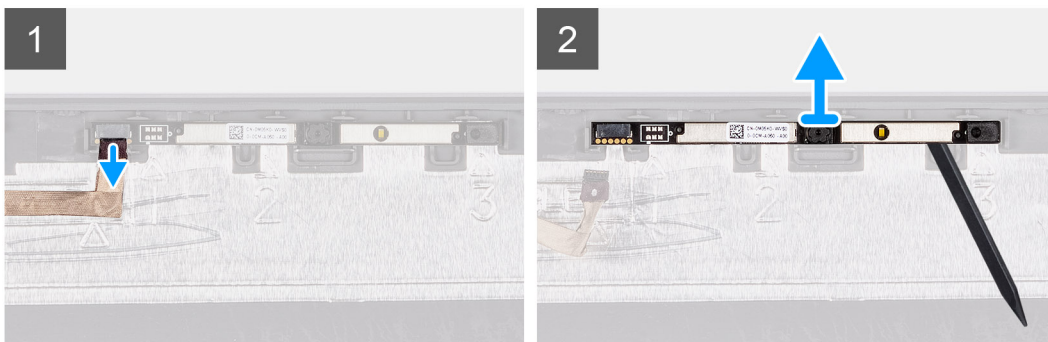
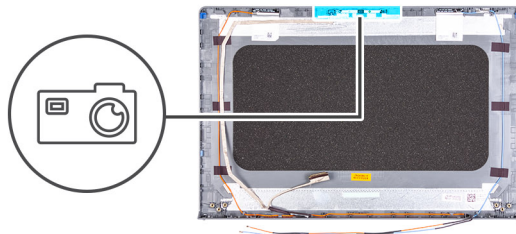

Steps

1. Using the pull tab, disconnect the camera cable from the camera module.
2. Using a plastic scribe, pry the camera module from the display assembly.

NOTE: Start prying the camera module in a sequential order 1>2>3 as indicated on the display back cover.

3. Lift the camera module from the display assembly.

Installing the camera module

Prerequisites

If you are replacing a component, remove the existing component before performing the installation process.

About this task

The following images indicate the location of the camera module and provides a visual representation of the installation procedure.

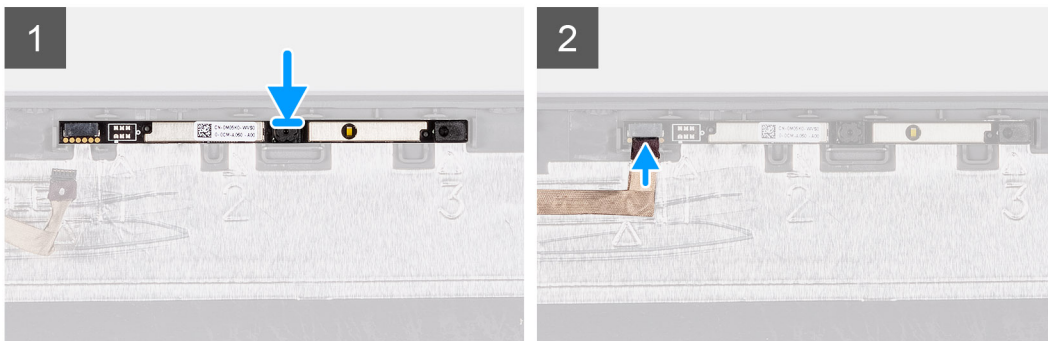
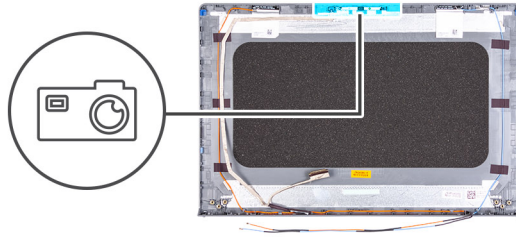

Steps

1. Adhere the camera module in its slot on the display assembly.
2. Connect the camera cable to the camera module.

Next steps

1. Install the [display hinge](#).
2. Install the [display panel](#).
3. Install the [display bezel](#).
4. Install the [display assembly](#).
5. Install the [wireless card](#).
6. Install the [base cover](#).
7. Install the [SD card](#).
8. Follow the procedure in [After working inside your computer](#).

Touchpad

Removing the touchpad

Prerequisites

1. Follow the procedure in [Before working inside your computer](#).
2. Remove the [SD card](#).

3. Remove the [base cover](#).
4. Remove the [battery](#).

About this task

The following images indicate the location of the touchpad and provides a visual representation of the removal procedure.



5x
M2x2

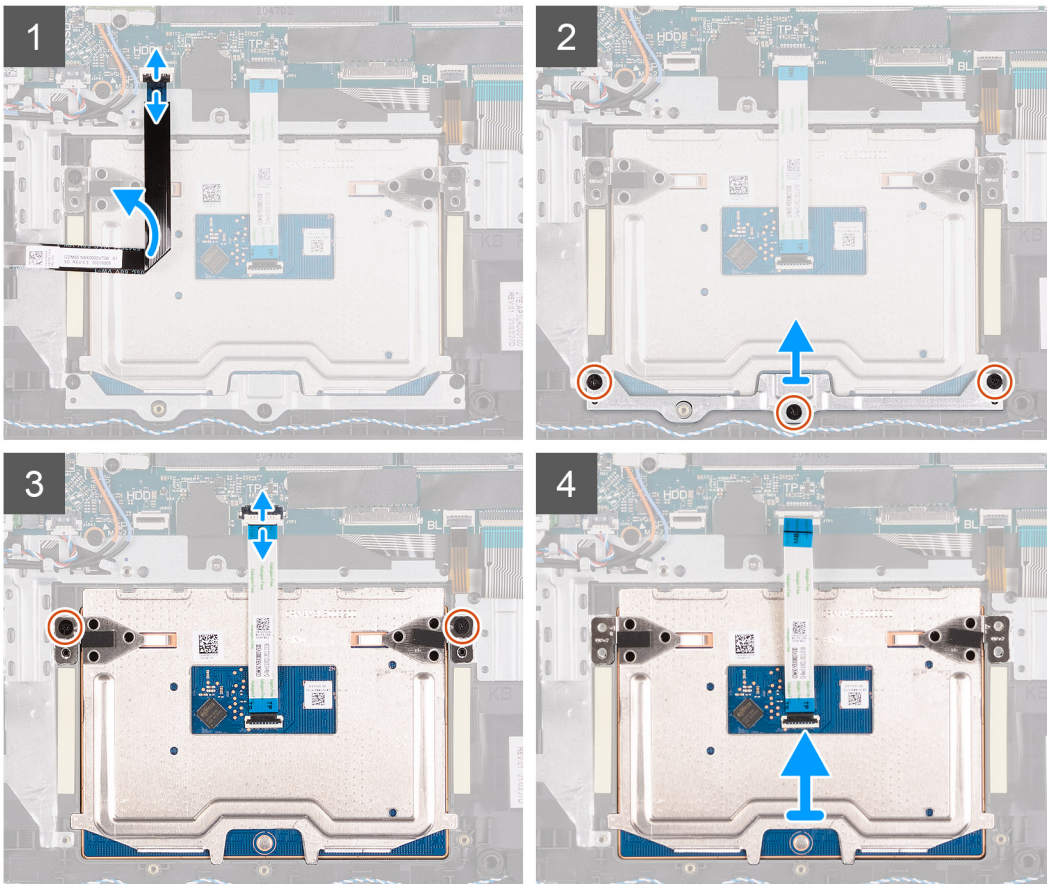
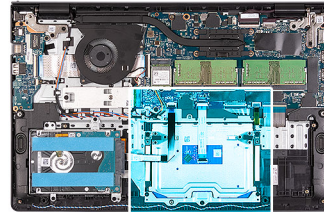

Steps

1. Open the latch and disconnect the hard drive cable from the connector on the system board.
2. Remove the three screws (M2x2) that secure the touchpad bracket to the palmrest and keyboard assembly.
3. Lift the touchpad bracket off the touchpad.
4. Open the latch and disconnect the touchpad Flexible Flat cable from the connector on the system board.
5. Remove the two screws (M2x2) that secure the touchpad to the palmrest and keyboard assembly.
6. Lift the touchpad from the palmrest and keyboard assembly.

Installing the touchpad

Prerequisites

If you are replacing a component, remove the existing component before performing the installation process.

About this task

The following images indicate the location of the touchpad and provides a visual representation of the installation procedure.



5x
M2x2

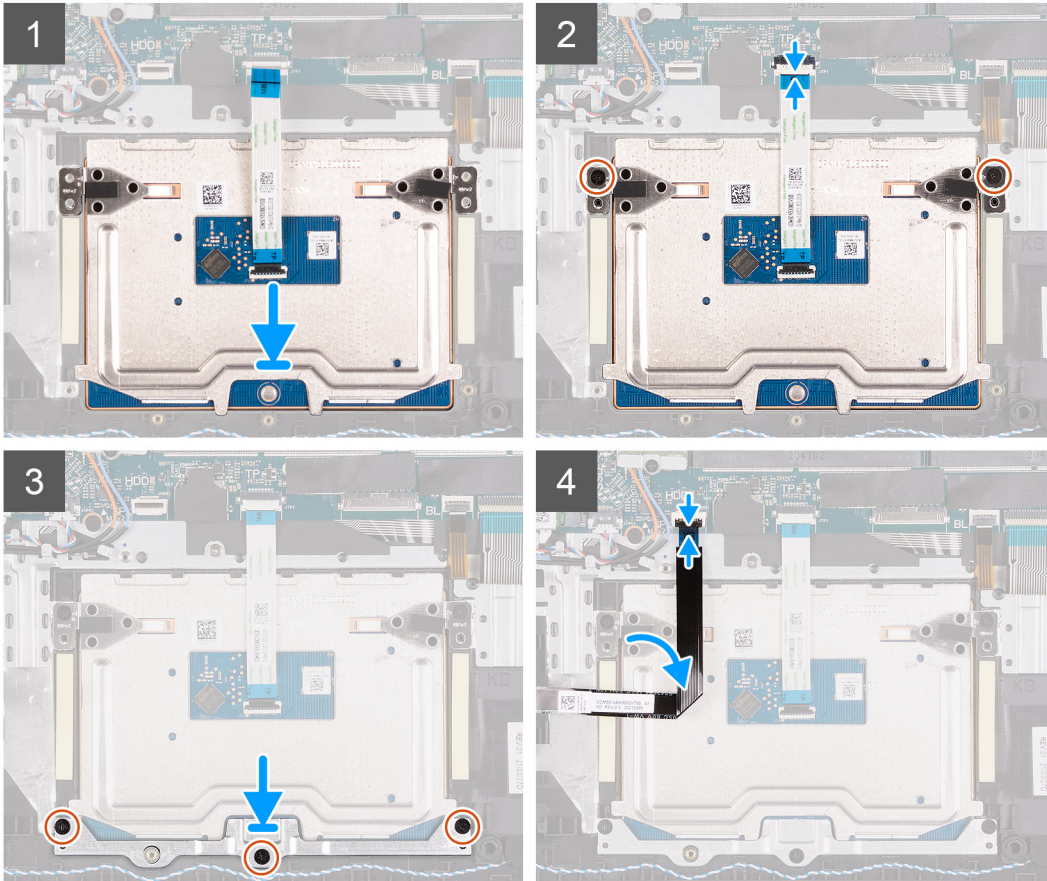
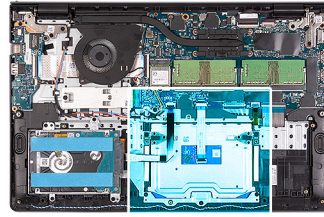

Steps

1. Place the touchpad into its slot on the palmrest and keyboard assembly.
2. Align the screw holes on the touchpad to the screw holes on the palmrest and keyboard assembly.
3. Replace the two screws (M2x2) that secure the touchpad to the palmrest and keyboard assembly.
4. Connect the touchpad Flexible Flat cable to the connector on the system board and close the latch.
5. Place the touchpad bracket on the touchpad.
6. Align the screw holes on the touchpad bracket to the screw holes on the palmrest and keyboard assembly.
7. Replace the three screws (M2x2) that secure the touchpad bracket to the palmrest and keyboard assembly.
8. Connect the hard drive cable to the connector on the system board.

Next steps

1. Install the [battery](#).
2. Install the [base cover](#).
3. Install the [SD card](#).
4. Follow the procedure in [After working inside your computer](#).

System board

System board connectors

The following image shows the different connectors on the system board.

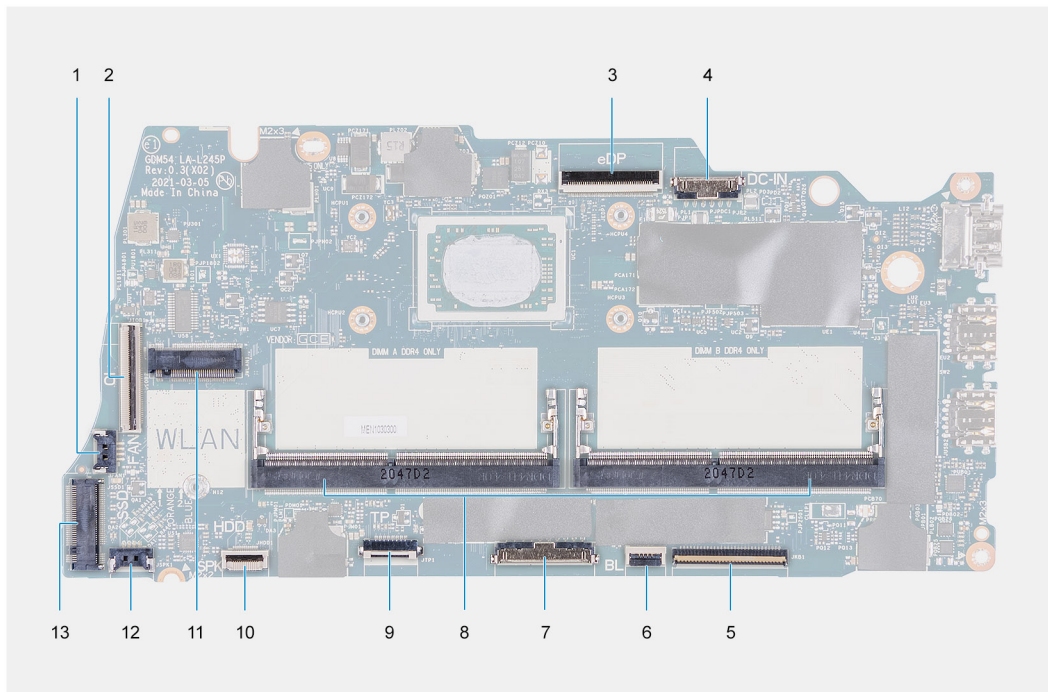

1. Fan connector
2. IO board FFC connector
3. eDP connector
4. DC-in port connector
5. Keyboard FFC connector
6. Backlit FFC connector
7. Memory module connectors
8. Battery connector
9. Touchpad FFC connector
10. Hard-drive FFC connector
11. WLAN connector
12. Speaker cable connector
13. SSD connector

Removing the system board

Prerequisites

1. Follow the procedure in [Before working inside your computer](#).
2. Remove the [SD card](#).
3. Remove the [base cover](#).
4. Remove the [battery](#).
5. Remove the [M.2 2230 solid-state drive](#).
6. Remove the [M.2 2280 solid-state drive](#).
7. Remove the [memory modules](#).
8. Remove the [fan](#).
9. Remove the [heat sink](#).

10. Remove the [wireless card](#).

About this task

The following images indicate the location of the system board and provides a visual representation of the removal procedure.

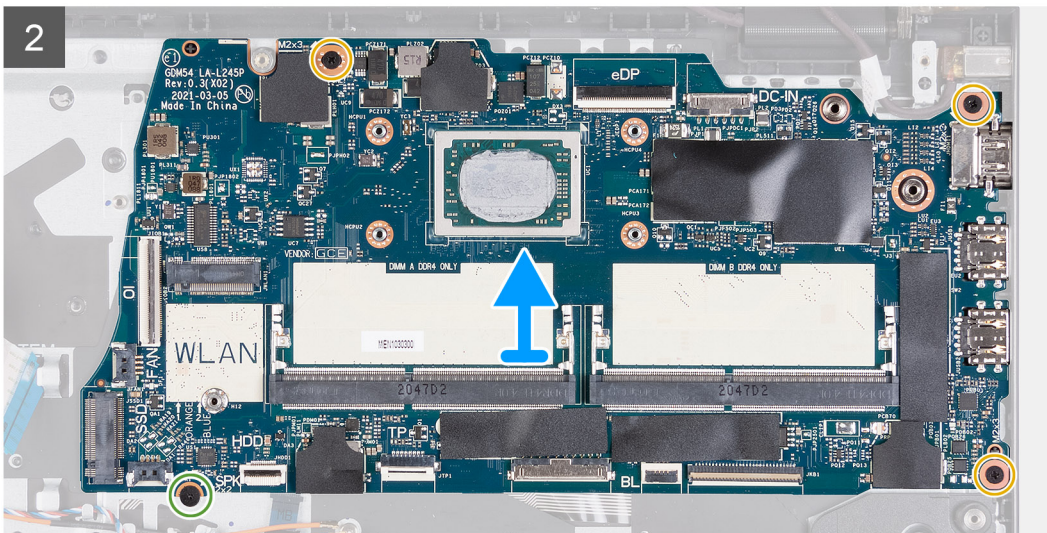
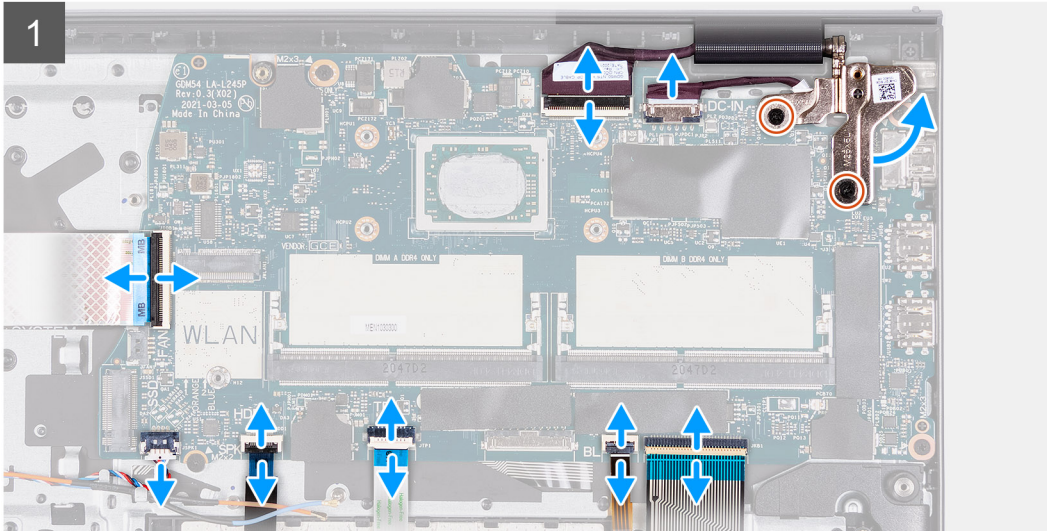
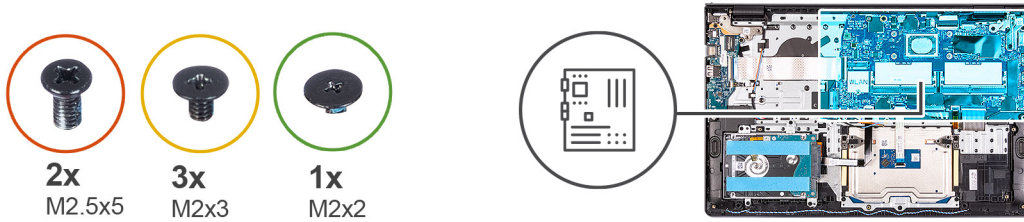

Steps

1. Remove the two (M2.5x5) screws from the right hinge.
2. Fold the right hinge up.
3. Disconnect the following cables from the system board:
 - a. I/O board Flexible Flat cable
 - b. Speaker cable
 - c. Hard drive Flexible Flat cable
 - d. Touchpad Flexible Flat cable
 - e. Keyboard backlight Flexible Printed cable

- f. Keyboard Flexible Printed cable
 - g. Power adapter port cable
 - h. display cable
4. Remove the three (M2x3) screws that secures the system board to the palmrest.
 5. Remove the single (M2x2) screw that secure the system board to the palmrest.
 6. Carefully lift the system board away from the chassis.

Installing the system board

Prerequisites

If you are replacing a component, remove the existing component before performing the installation process.

About this task

The following images indicate the location of the system board and provides a visual representation of the installation procedure.

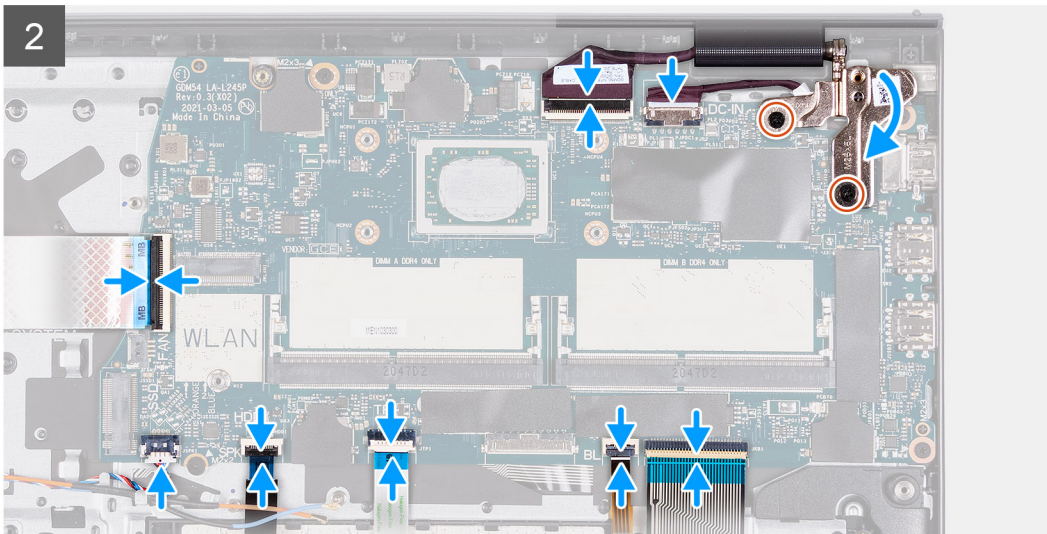
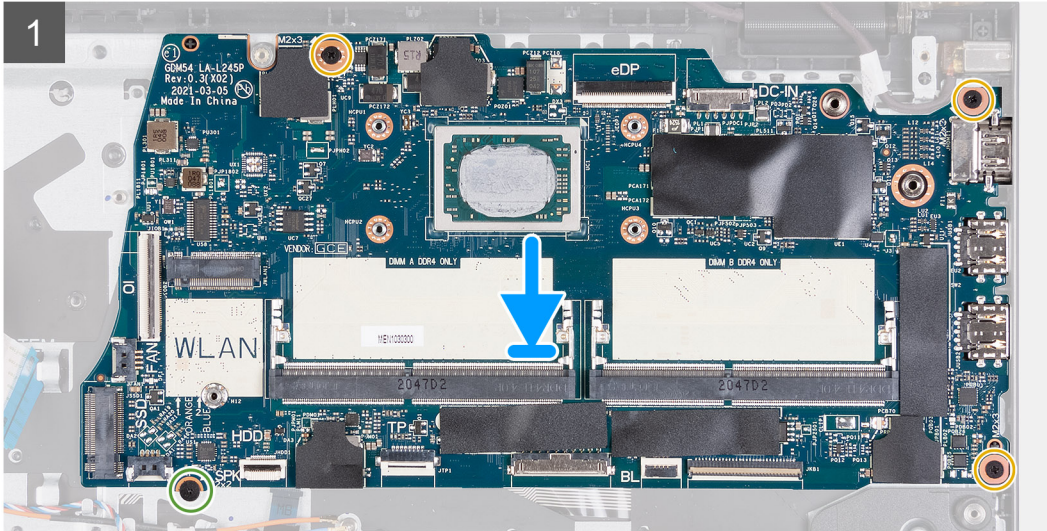
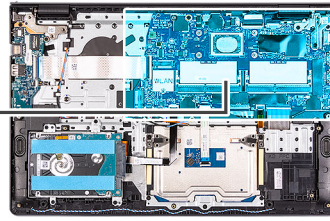

Steps

1. Align and place the system board on the palmrest.
2. Replace the single (M2x2) screw that secures the system board to the palmrest.
3. Replace the three (M2x3) screws that secures the system board to the palmrest.
4. Connect the following cables to the system board:
 - a. I/O board Flexible Flat cable
 - b. Speaker cable
 - c. Hard drive Flexible Flat cable
 - d. Touchpad Flexible Flat cable
 - e. Keyboard backlight Flexible Printed cable
 - f. Keyboard Flexible Printed cable
 - g. Power adapter port cable
 - h. Display cable

5. Fold back the right hinge and replace the two (M2.5x5) screws to secure it to the palmrest.

Next steps

1. Install the [wireless card](#).
2. Install the [heat sink](#).
3. Install the [fan](#).
4. Install the [memory modules](#).
5. Install the [M.2 2230 solid-state drive](#).
6. Install the [M.2 2280 solid-state drive](#).
7. Install the [battery](#).
8. Install the [base cover](#).
9. Install the [SD card](#).
10. Follow the procedure in [After working inside your computer](#).

Power-adapter port

Removing the power-adapter port

Prerequisites

1. Follow the procedure in [Before working inside your computer](#).
2. Remove the [SD card](#).
3. Remove the [base cover](#).

About this task

The following images indicate the location of the power-adapter port and provides a visual representation of the removal procedure.



2x
M2.5x5

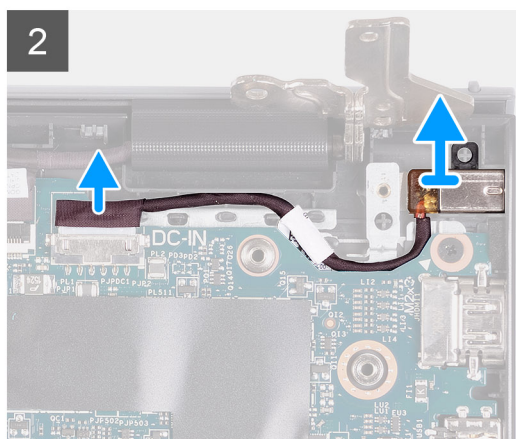
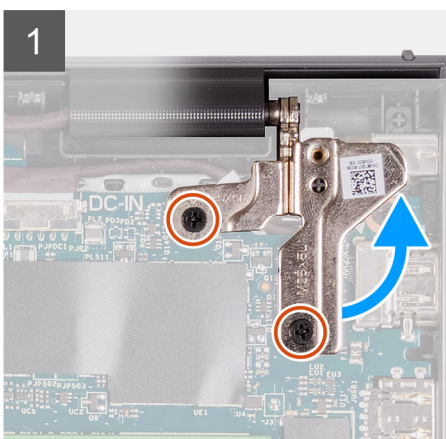
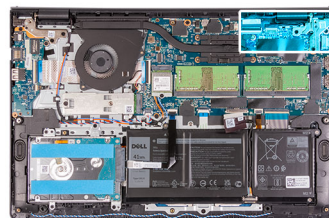

Steps

1. Remove the two (M2.5x5) screws that secure the right hinge to the palmrest and keyboard assembly.
2. Disconnect the power-adapter cable from the connector on the system board.
3. Lift the power-adapter port from its slot on the palmrest and keyboard assembly.

Installing the power-adapter port

Prerequisites

If you are replacing a component, remove the existing component before performing the installation process.

About this task

The following images indicate the location of the power-adapter port and provides a visual representation of the installation procedure.



2x
M2.5x5

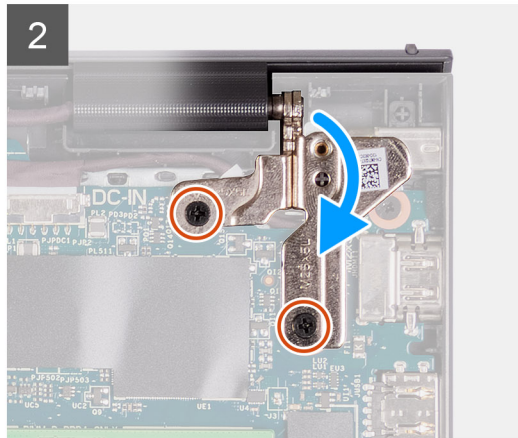
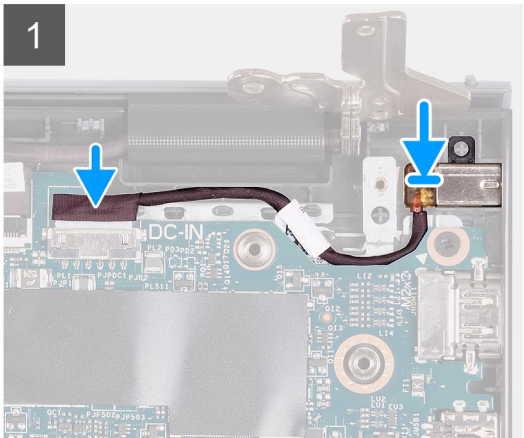
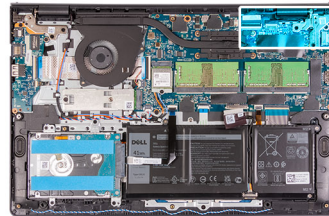

Steps

1. Using the alignment post, place the power-adapter port into its slot on the palmrest and keyboard assembly.
2. Connect the power-adapter port cable to the connector on the system board.
3. Fold the right hinge down and install the two (M2.5x5) screws to secure it to the palmrest and keyboard assembly.

Next steps

1. Install the [base cover](#).
2. Install the [SD card](#).
3. Follow the procedure in [After working inside your computer](#).

Palm-rest and keyboard assembly

Removing the palmrest and keyboard assembly

Prerequisites

1. Follow the procedure in [Before working inside your computer](#).
2. Remove the [SD card](#).
3. Remove the [base cover](#).
4. Remove the [battery](#).
5. Remove the [M.2 2230 solid-state drive](#).

6. Remove the [M.2 2280 solid-state drive](#).
 7. Remove the [wireless card](#).
 8. Remove the [I/O board](#).
 9. Remove the [hard drive assembly](#).
 10. Remove the [memory modules](#).
 11. Remove the [speakers](#).
 12. Remove the [heat sink](#).
 13. Remove the [fan](#).
 14. Remove the [power button](#).
 15. Remove the [display assembly](#).
 16. Remove the [touchpad](#).
 17. Remove the [system board](#).
- i** **NOTE:** The system board can be removed along with the heat sink.
18. Remove the [power-adapter port](#).

About this task

The following images indicate the location of the palmrest and keyboard assembly and provides a visual representation of the removal procedure.

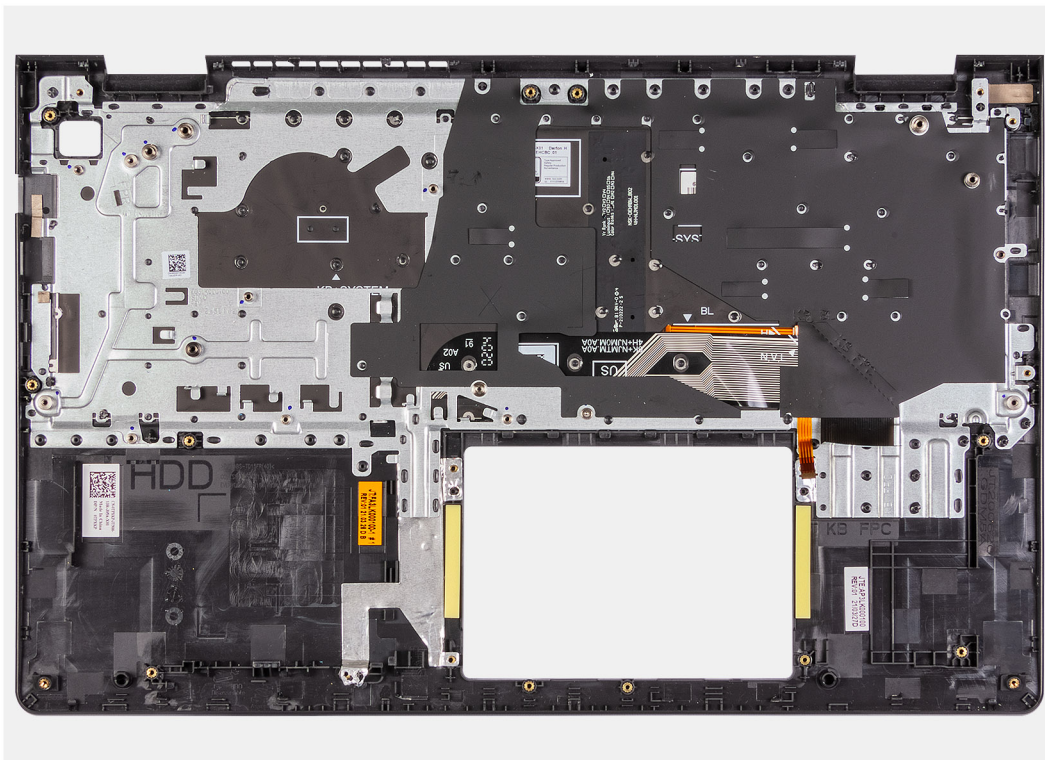

Steps

After performing the pre-requisites you are left with the palm-rest and keyboard assembly.

Installing the palmrest and keyboard assembly

Prerequisites

If you are replacing a component, remove the existing component before performing the installation process.

About this task

The following images indicate the location of the palmrest and keyboard assembly and provides a visual representation of the installation procedure.

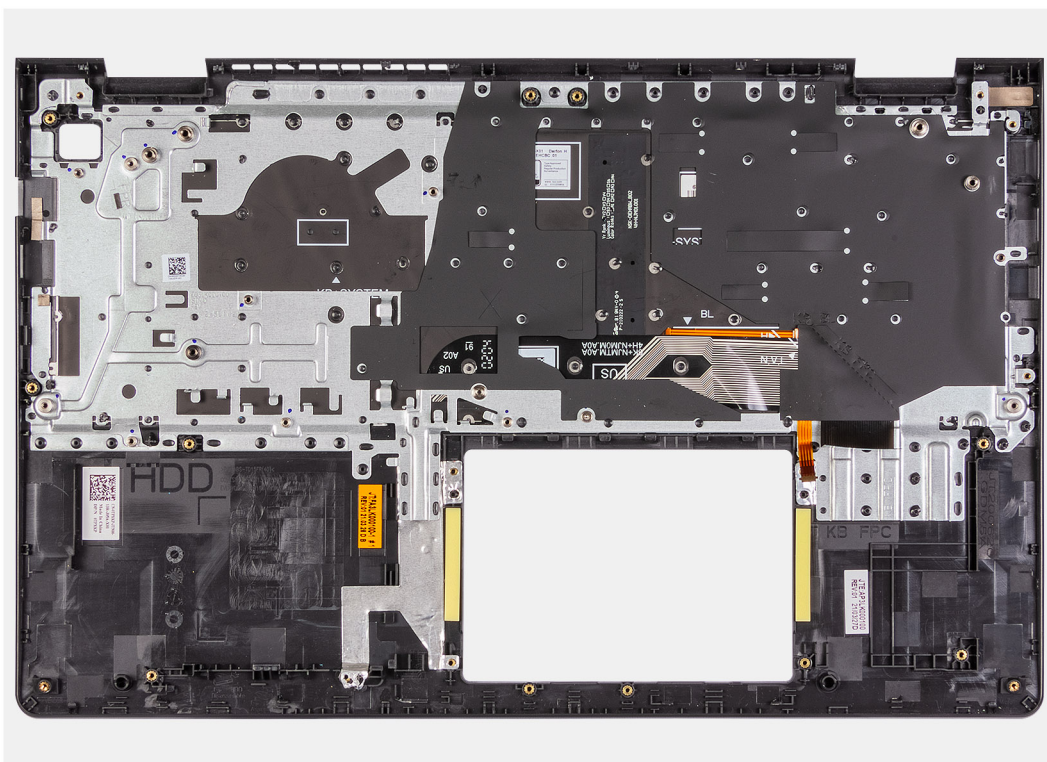

Steps

Place the palm-rest and keyboard assembly on a flat and clean surface and perform the post-requisites to install the palm-rest and keyboard assembly.

Next steps

1. Install the [power-adaptor port](#).
2. Install the [system board](#).
3. Install the [touchpad](#).
4. Install the [display assembly](#).
5. Install the [power button](#).
6. Install the [fan](#).
7. Install the [heat sink](#).
8. Install the [speakers](#).
9. Install the [memory modules](#).
10. Install the [hard drive assembly](#).
11. Install the [I/O board](#).
12. Install the [wireless card](#).
13. Install the [M.2 2230 solid-state drive](#).
14. Install the [M.2 2280 solid-state drive](#).
15. Install the [battery](#).
16. Install the [base cover](#).
17. Install the [SD card](#).
18. Follow the procedure in [After working inside your computer](#).

Drivers and downloads

When troubleshooting, downloading, or installing drivers, it is recommended that you read the Dell knowledge base article, [Drivers and Downloads FAQs](#) .

System setup

CAUTION: Unless you are an expert computer user, do not change the settings in the BIOS Setup program. Certain changes can make your computer work incorrectly.

NOTE: Before you change BIOS Setup program, it is recommended that you write down the BIOS Setup program screen information for future reference.

Use the BIOS Setup program for the following purposes:

- Get information about the hardware installed in your computer, such as the amount of RAM and the size of the hard drive.
- Change the system configuration information.
- Set or change a user-selectable option, such as the user password, type of hard drive installed, and enabling or disabling base devices.

Boot menu

Press <F12> when the Dell logo appears to initiate a one-time boot menu with a list of the valid boot devices for the system. Diagnostics and BIOS Setup options are also included in this menu. The devices listed on the boot menu depend on the bootable devices in the system. This menu is useful when you are attempting to boot to a particular device or to bring up the diagnostics for the system. Using the boot menu does not make any changes to the boot order stored in the BIOS.

The options are:

- **UEFI Boot Devices:**
 - Windows Boot Manager
 - UEFI Hard Drive
 - Onboard NIC (IPV4)
 - Onboard NIC (IPV6)
- **Pre-Boot Tasks:**
 - BIOS Setup
 - Diagnostics
 - BIOS Update
 - SupportAssist OS Recovery
 - BIOS Flash Update - Remote
 - Device Configuration

Navigation keys

NOTE: For most of the System Setup options, changes that you make are recorded but do not take effect until you restart the system.

Keys	Navigation
Up arrow	Moves to the previous field.
Down arrow	Moves to the next field.
Enter	Selects a value in the selected field (if applicable) or follow the link in the field.
Spacebar	Expands or collapses a drop-down list, if applicable.
Tab	Moves to the next focus area.
Esc	Moves to the previous page until you view the main screen. Pressing Esc in the main screen displays a message that prompts you to save any unsaved changes and restarts the system.

Boot Sequence

Boot Sequence allows you to bypass the System Setup–defined boot device order and boot directly to a specific device (for example: optical drive or hard drive). During the Power-on Self Test (POST), when the Dell logo appears, you can:

- Access System Setup by pressing F2 key
- Bring up the one-time boot menu by pressing F12 key

The one-time boot menu displays the devices that you can boot from including the diagnostic option. The boot menu options are:

- Removable Drive (if available)
- STXXXX Drive (if available)
i **NOTE:** XXX denotes the SATA drive number.
- Optical Drive (if available)
- SATA Hard Drive (if available)
- Diagnostics

The boot sequence screen also displays the option to access the System Setup screen.

System setup options

i **NOTE:** Depending on your computer and its installed devices, the items listed in this section may or may not appear.

Table 3. System setup options—Main menu

Main	
System Time	Displays the current time in hh:mm:ss format.
System Date	Displays the current date in mm/dd/yyyy format.
BIOS Version	Displays the BIOS version.
Product Name	Displays the model number of your computer.
Service Tag	Displays the service tag of your computer.
Asset Tag	Displays the asset tag of your computer.
CPU Type	Displays the processor type.
CPU Speed	Displays the processor speed.
CPU ID	Displays the processor identification code.
CPU Cache	
L1 Cache	Displays the processor L1 cache size.
L2 Cache	Displays the processor L2 cache size.
L3 Cache	Displays the processor L3 cache size.
First HDD	Displays the type of hard drive installed.
AC Adapter Type	Displays the type of AC adapter.
System Memory	Displays the size of memory installed.
Memory Speed	Displays the speed of memory.
Keyboard Type	Displays the type of keyboard installed on the computer.

Table 4. System setup options—Advanced menu

Advanced	
Virtualization	Enables or disables the Virtualization technology.

Table 4. System setup options—Advanced menu (continued)

Advanced	
VI for Direct I/O	<p>Default: Enabled</p> <p>Enables or disables the Virtualization technology for Direct I/O.</p>
Integrated NIC	<p>Default: Enabled</p> <p>Enables or disables the on-board LAN controller.</p> <p>Default: Enabled</p>
USB Emulation	<p>Enables or disables the USB emulation feature. This feature defines how the BIOS, in the absence of a USB-aware operating system, handles USB devices. USB emulation is always enabled during POST.</p> <p>i NOTE: You cannot boot any type of USB device (floppy, hard drive, or memory key) when this option is off.</p>
USB Wake Support	<p>Default: Enabled</p> <p>Allows you to enable USB devices to wake the computer from standby or to disable the USB wake support feature.</p> <p>i NOTE: If USB PowerShare is enabled, a device connected to the USB PowerShare connector may not wake the computer.</p> <p>i NOTE: To enable wake support for the fingerprint reader the USB Wake Support needs to be enabled in the BIOS. To enable USB wake support, complete the steps in the knowledge base article SLN321473.</p>
SATA Operation	<p>Default: Disabled</p> <p>Allows you to configure the operating mode of the integrated SATA hard drive controller.</p> <p>Default: AHCI</p>
Adapter Warnings	<p>Allows you to choose if the computer should display warning messages when you use AC adapters that are not supported by your computer.</p> <p>Default: Enabled</p>
Function Key Behavior	<p>Allows you to set function key or multimedia key as the default function key behavior.</p> <p>Default: Multimedia key</p>
Keyboard Illumination	<p>Selects the operating mode of the keyboard illumination feature.</p> <p>Default: Bright</p>
Keyboard Backlight with AC	<p>Selects the timeout value for the keyboard backlight when an AC adapter is plugged into the computer.</p> <p>Default: 1 minute</p>
Keyboard Backlight with Battery	<p>Selects the timeout value for the keyboard backlight when the computer is running on battery power.</p> <p>Default: 1 minute</p>
Battery Health	<p>Displays the battery health.</p>
Camera	<p>Enables or disables the camera.</p>

Table 4. System setup options—Advanced menu (continued)

Advanced	
Battery Charge Configuration	<p>Default: Disabled</p> <p>Set the battery charge settings with a preselected custom charge start and stop.</p> <p>Default: Adaptive</p>
Advanced Battery Charge Configuration	<p>Enable Advanced Battery Charge Configuration from the beginning of the day to a specified work period.</p> <p>Default: Disabled</p>
Maintenance	
Data Wipe on next boot	<p>Enables or disables data wipe on the next boot.</p> <p>Default: Disabled</p>
BIOS Recovery from Hard Drive	<p>Enables the user to recover from certain corrupted BIOS conditions from a recovery file on the user primary hard drive or an external USB key.</p>
BIOS Auto-Recovery	<p>Enables BIOS to automatically recover BIOS without user actions.</p> <p>Default: Disabled</p>
SupportAssist System Resolution	
Auto OS Recovery Threshold	<p>Controls the automatic boot flow for SupportAssist System Resolution Console and for the Dell OS Recovery tool.</p> <p>Default: 2</p>
SupportAssist OS Recovery	<p>Enables or disables the boot flow for the SupportAssist OS Recovery tool in the even of certain system errors.</p> <p>Default: Disabled</p>

Table 5. System setup options—Security menu

Security	
Admin Password Status	<p>Displays if the administrator password is clear or set.</p> <p>Default: Not Set</p>
System Password Status	<p>Displays if the system password is clear or set.</p> <p>Default: Not Set</p>
HDD Password	<p>Displays if the system password is clear or set.</p> <p>Default: Not Set</p>
Service Tag	<p>Set your system's Service Tag.</p>
Asset Tag	<p>Set your system's Asset Tag.</p>
Admin Password	<p>Allows you to set the administrator password. The administrator password controls access to the system setup utility.</p>
System Password	<p>Allows you to set the system password. The system password controls access to the computer at boot.</p>
HDD Password	<p>Allows you to set the HDD password. The HDD password controls access to the computers HDD.</p>
Password Change	<p>Allows you to permit or deny system password or HDD password changes.</p>

Table 5. System setup options—Security menu (continued)

Security	
Absolute®	<p>Default: Permitted</p> <p>Allows you to track your computer</p> <p>Default: enabled</p>
Absolute® Status	<p>Allows you to activate or deactivate the Absolute® feature</p> <p>Displays if the system password is clear or set.</p> <p>Default: Deactivate</p>
WINDOWS SMM SECURITY MITIGATIONS TABLE (WSMT)	<p>Enables or disables configuration of platform features on Dell Client Systems with WSMT-enabled BIOS.</p> <p>Default: Enabled</p>
Firmware TPM	<p>Enable or disable the firmware TPM.</p> <p>Default: Enabled</p>
PPI Bypass for Clear Command	<p>Allows you to control the TPM Physical Presence Interface (PPI). When enabled, this setting will allow the OS to skip BIOS PPI user prompts when issuing the Clear command. Changes to this setting take effect immediately.</p> <p>Default: Disabled</p>
TPM Security	<p>TPM 2.0 Security options.</p>
UEFI Firmware Capsule Updates	<p>Enables or disables BIOS updates through UEFI capsule update packages.</p> <p>Default: Enabled</p>
Secure Boot	<p>Enables or disables Secure Boot.</p> <p>Default: Enabled</p>

Table 6. System setup options—Boot menu

Boot	
File Browser Add Boot Option	Allows you to add boot options.

Table 7. System setup options—Exit menu

Exit	
Exit Saving Changes	Allows you to exit system setup and save your changes.
Save Change Without Exit	Allows you to save your changes without exiting the BIOS setup.
Exit Discarding Changes	Allows you to exit the BIOS setup without saving the changes.
Load Optimal Defaults	Allows you to restore default values for all system setup options.
Discard Changes	Allows you to load previous values for all system setup options.

Updating the BIOS

Updating the BIOS in Windows

About this task

 **CAUTION:** If BitLocker is not suspended before updating the BIOS, the next time you reboot the system it will not recognize the BitLocker key. You will then be prompted to enter the recovery key to progress and the system will ask for this on each reboot. If the recovery key is not known this can result in data loss or an unnecessary operating system re-install. For more information on this subject, see Knowledge Article: <https://www.dell.com/support/article/sln153694>

Steps

1. Go to www.dell.com/support.
2. Click **Product support**. In the **Search support** box, enter the Service Tag of your computer, and then click **Search**.
 **NOTE:** If you do not have the Service Tag, use the SupportAssist feature to automatically identify your computer. You can also use the product ID or manually browse for your computer model.
3. Click **Drivers & Downloads**. Expand **Find drivers**.
4. Select the operating system installed on your computer.
5. In the **Category** drop-down list, select **BIOS**.
6. Select the latest version of BIOS, and click **Download** to download the BIOS file for your computer.
7. After the download is complete, browse the folder where you saved the BIOS update file.
8. Double-click the BIOS update file icon and follow the on-screen instructions.
For more information, see knowledge base article [000124211](https://www.dell.com/support/article/000124211) at www.dell.com/support.

Updating the BIOS in Linux and Ubuntu

To update the system BIOS on a computer that is installed with Linux or Ubuntu, see the knowledge base article [000131486](https://www.dell.com/support/article/000131486) at www.dell.com/support.

Updating the BIOS using the USB drive in Windows

About this task

 **CAUTION:** If BitLocker is not suspended before updating the BIOS, the next time you reboot the system it will not recognize the BitLocker key. You will then be prompted to enter the recovery key to progress and the system will ask for this on each reboot. If the recovery key is not known this can result in data loss or an unnecessary operating system re-install. For more information on this subject, see Knowledge Article: <https://www.dell.com/support/article/sln153694>

Steps

1. Follow the procedure from step 1 to step 6 in [Updating the BIOS in Windows](#) to download the latest BIOS setup program file.
2. Create a bootable USB drive. For more information, see the knowledge base article [000145519](https://www.dell.com/support/article/000145519) at www.dell.com/support.
3. Copy the BIOS setup program file to the bootable USB drive.
4. Connect the bootable USB drive to the computer that needs the BIOS update.
5. Restart the computer and press **F12**.
6. Select the USB drive from the **One Time Boot Menu**.
7. Type the BIOS setup program filename and press **Enter**.
The **BIOS Update Utility** appears.
8. Follow the on-screen instructions to complete the BIOS update.

Updating the BIOS from the F12 One-Time boot menu

Update your computer BIOS using the BIOS update.exe file that is copied to a FAT32 USB drive and booting from the F12 One-Time boot menu.

About this task

CAUTION: If BitLocker is not suspended before updating the BIOS, the next time you reboot the system it will not recognize the BitLocker key. You will then be prompted to enter the recovery key to progress and the system will ask for this on each reboot. If the recovery key is not known this can result in data loss or an unnecessary operating system re-install. For more information on this subject, see Knowledge Article: <https://www.dell.com/support/article/sln153694>

BIOS Update

You can run the BIOS update file from Windows using a bootable USB drive or you can also update the BIOS from the F12 One-Time boot menu on the computer.

Most of the Dell computers built after 2012 have this capability, and you can confirm by booting your computer to the F12 One-Time Boot Menu to see if BIOS FLASH UPDATE is listed as a boot option for your computer. If the option is listed, then the BIOS supports this BIOS update option.

NOTE: Only computers with BIOS Flash Update option in the F12 One-Time boot menu can use this function.

Updating from the One-Time boot menu

To update your BIOS from the F12 One-Time boot menu, you need the following:

- USB drive formatted to the FAT32 file system (key does not have to be bootable)
- BIOS executable file that you downloaded from the Dell Support website and copied to the root of the USB drive
- AC power adapter that is connected to the computer
- Functional computer battery to flash the BIOS

Perform the following steps to perform the BIOS update flash process from the F12 menu:

CAUTION: Do not turn off the computer during the BIOS update process. The computer may not boot if you turn off your computer.

Steps

1. From a turn off state, insert the USB drive where you copied the flash into a USB port of the computer.
2. Turn on the computer and press F12 to access the One-Time Boot Menu, select BIOS Update using the mouse or arrow keys then press Enter.
The flash BIOS menu is displayed.
3. Click **Flash from file**.
4. Select external USB device.
5. Select the file and double-click the flash target file, and then click **Submit**.
6. Click **Update BIOS**. The computer restarts to flash the BIOS.
7. The computer will restart after the BIOS update is completed.

System and setup password

Table 8. System and setup password

Password type	Description
System password	Password that you must enter to log on to your system.
Setup password	Password that you must enter to access and make changes to the BIOS settings of your computer.

You can create a system password and a setup password to secure your computer.

 **CAUTION:** The password features provide a basic level of security for the data on your computer.

 **CAUTION:** Anyone can access the data stored on your computer if it is not locked and left unattended.

 **NOTE:** System and setup password feature is disabled.

Assigning a system setup password

Prerequisites

You can assign a new **System or Admin Password** only when the status is in **Not Set**.

About this task

To enter the system setup, press F12 immediately after a power-on or reboot.

Steps

1. In the **System BIOS** or **System Setup** screen, select **Security** and press Enter.
The **Security** screen is displayed.
2. Select **System/Admin Password** and create a password in the **Enter the new password** field.
Use the following guidelines to assign the system password:
 - A password can have up to 32 characters.
 - The password can contain the numbers 0 through 9.
 - Only lower case letters are valid, upper case letters are not valid.
 - Only the following special characters are valid: Space, ("), (+), (.), (-), (.), (/), (:), ([), (\), (]), (`).
3. Type the system password that you entered earlier in the **Confirm new password** field and click **OK**.
4. Press F10 to save the changes.
The computer restarts.

Deleting or changing an existing system setup password

Prerequisites

Ensure that the **Password Status** is Unlocked (in the System Setup) before attempting to delete or change the existing System password. You cannot delete or change an existing System password, if the **Password Status** is Locked.

About this task

To enter the System Setup, press F12 immediately after a power-on or reboot.

Steps

1. In the **System BIOS** or **System Setup** screen, select **System Security** and press Enter.
The **System Security** screen is displayed.
2. In the **System Security** screen, verify that **Password Status** is **Unlocked**.
3. Select **System Password**, update, or delete the existing system password, and press Enter or Tab.
 **NOTE:** If you change the System password, reenter the new password when prompted. To delete the System and/or Setup password, key in a blank entry into the password window and hit enter.
4. Press F10 to save the changes.
The computer restarts.

Clearing BIOS (System Setup) and System passwords

About this task

To clear the system or BIOS passwords, contact Dell technical support as described at www.dell.com/contactdell.

 **NOTE:** For information on how to reset Windows or application passwords, refer to the documentation accompanying Windows or your application.

Troubleshooting

Handling swollen Lithium-ion batteries

Like most laptops, Dell laptops use lithium-ion batteries. One type of lithium-ion battery is the lithium-ion polymer battery. Lithium-ion polymer batteries have increased in popularity in recent years and have become standard in the electronics industry due to customer preferences for a slim form factor (especially with newer ultra-thin laptops) and long battery life. Inherent to lithium-ion polymer battery technology is the potential for swelling of the battery cells.

Swollen battery may impact the performance of the laptop. To prevent possible further damage to the device enclosure or internal components leading to malfunction, discontinue the use of the laptop and discharge it by disconnecting the AC adapter and letting the battery drain.

Swollen batteries should not be used and should be replaced and disposed of properly. We recommend contacting Dell product support for options to replace a swollen battery under the terms of the applicable warranty or service contract, including options for replacement by a Dell authorized service technician.

The guidelines for handling and replacing Lithium-ion batteries are as follows:

- Exercise caution when handling Lithium-ion batteries.
- Discharge the battery before removing it from the system. To discharge the battery, unplug the AC adapter from the system and operate the system only on battery power. When the system will no longer power on when the power button is pressed, the battery is fully discharged.
- Do not crush, drop, mutilate, or penetrate the battery with foreign objects.
- Do not expose the battery to high temperatures, or disassemble battery packs and cells.
- Do not apply pressure to the surface of the battery.
- Do not bend the battery.
- Do not use tools of any type to pry on or against the battery.
- If a battery gets stuck in a device as a result of swelling, do not try to free it as puncturing, bending, or crushing a battery can be dangerous.
- Do not attempt to reassemble a damaged or swollen battery into a laptop.
- Swollen batteries that are covered under warranty should be returned to Dell in an approved shipping container (provided by Dell)—this is to comply with transportation regulations. Swollen batteries that are not covered under warranty should be disposed of at an approved recycling center. Contact Dell product support at <https://www.dell.com/support> for assistance and further instructions.
- Using a non-Dell or incompatible battery may increase the risk of fire or explosion. Replace the battery only with a compatible battery purchased from Dell that is designed to work with your Dell computer. Do not use a battery from other computers with your computer. Always purchase genuine batteries from <https://www.dell.com> or otherwise directly from Dell.

Lithium-ion batteries can swell for various reasons such as age, number of charge cycles, or exposure to high heat. For more information on how to improve the performance and lifespan of the laptop battery and to minimize the possibility of occurrence of the issue, see [Dell Laptop Battery - Frequently Asked Questions](#).

Dell SupportAssist Pre-boot System Performance Check diagnostics

About this task

SupportAssist diagnostics (also known as system diagnostics) performs a complete check of your hardware. The Dell SupportAssist Pre-boot System Performance Check diagnostics is embedded with the BIOS and is launched by the BIOS internally. The embedded system diagnostics provides a set of options for particular devices or device groups allowing you to:

- Run tests automatically or in an interactive mode
- Repeat tests
- Display or save test results

- Run thorough tests to introduce additional test options to provide extra information about the failed device(s)
- View status messages that inform you if tests are completed successfully
- View error messages that inform you of problems encountered during testing

NOTE: Some tests for specific devices require user interaction. Always ensure that you are present at the computer terminal when the diagnostic tests are performed.

For more information, see <https://www.dell.com/support/kbdoc/000180971>.

Running the SupportAssist Pre-Boot System Performance Check

Steps

1. Turn on your computer.
2. As the computer boots, press the F12 key as the Dell logo appears.
3. On the boot menu screen, select the **Diagnostics** option.
4. Click the arrow at the bottom left corner.
Diagnostics front page is displayed.
5. Click the arrow in the lower-right corner to go to the page listing.
The items detected are listed.
6. To run a diagnostic test on a specific device, press Esc and click **Yes** to stop the diagnostic test.
7. Select the device from the left pane and click **Run Tests**.
8. If there are any issues, error codes are displayed.
Note the error code and validation number and contact Dell.

Enhanced Pre-Boot System Assessment (ePSA) diagnostics

About this task

The SupportAssist diagnostics (also known as system diagnostics) performs a complete check of your hardware. The SupportAssist diagnostics is embedded with the BIOS and is launched by the BIOS internally. The embedded system diagnostics provides a set of options for particular devices or device groups allowing you to:

- Run tests automatically or in an interactive mode
- Repeat tests
- Display or save test results
- Run thorough tests to introduce additional test options to provide extra information about the failed device(s)
- View status messages that inform you if tests are completed successfully
- View error messages that inform you of problems encountered during testing

NOTE: The **SupportAssist** window displays, listing all devices detected in the computer. The diagnostics starts running the tests on all the detected devices.

Running SupportAssist diagnostics

Steps

1. Turn on your computer.
2. As the computer boots, press the F12 key as the Dell logo appears.
3. On the boot menu screen, select the **Diagnostics** option.
4. Click the arrow at the bottom left corner.
Diagnostics front page is displayed.
5. Click the arrow in the lower-right corner to go to the page listing.
The items detected are listed.
6. To run a diagnostic test on a specific device, press Esc and click **Yes** to stop the diagnostic test.
7. Select the device from the left pane and click **Run Tests**.

8. If there are any issues, error codes are displayed.
Note the error code and validation number and contact Dell.

SupportAssist diagnostic User Interface

SupportAssist diagnostic User Interface

About this task

This section contains information on Support Assist Basic and Advanced Screen.

SupportAssist opens the basic screen on start. You can switch to the advanced screen using the icon at the bottom left of the screen. The advanced screen shows detected devices in a tiled format. Specific tests can be included or excluded only in the advanced mode. The Basic Screen has minimal controls which allows easy navigation for the user to start or stop the diagnostics.

System diagnostic lights

Power and battery-status light

Indicates the power and battery-charge status.

Solid white—Power adapter is connected and the battery has more than 5% charge.

Amber—Computer is running on battery and the battery has less than 5% charge.

Off

- Power adapter is connected, and the battery is fully charged.
- Computer is running on battery, and the battery has more than 5% charge.
- Computer is in sleep state, hibernation, or turned off.

The power and battery-status light blinks amber along with beep codes indicating failures.

For example, the power and battery-status light blinks amber two times followed by a pause, and then blinks white three times followed by a pause. This 2,3 pattern continues until the computer is turned off indicating no memory or RAM is detected.

The following table shows different power and battery-status light patterns and associated problems.

Table 9. LED codes

Diagnostic light codes	Problem description	Recommended solutions
1,3	Short in hinge cable tripped OCP1	Check if the display cable (EDP) is seated properly or pinched at the hinges. If problem persists, replace either display cable (EDP) or display assembly (LCD).
1,4	Short in hinge cable tripped OCP2	Check if the display cable (EDP) is seated properly or pinched at the hinges. If problem persists, replace either display cable (EDP) or display assembly (LCD).
2,1	Processor failure	Run the Intel CPU diagnostics tools. If problem persists, replace the system board.
2,3	No memory or RAM (Random-Access Memory) detected	Confirm that the memory module is installed properly. If problem persists, replace the memory module.
2,4	Memory or RAM (Random-Access Memory) failure	Reset and swap memory modules amongst the slots. If problem persists, replace the memory module.
2,7	LCD failure - SBIOS message	Replace display cable (EDP) if possible, otherwise replace the display assembly (LCD).
2,8	LCD failure - EC detection of power rail failure	Replace the system board.

Table 9. LED codes (continued)

Diagnostic light codes	Problem description	Recommended solutions
3,1	Coin-cell battery failure	Reset the CMOS battery connection. If problem persists, replace the RTC battery.
3,3	Recovery image not found	Flash latest BIOS version. If problem persists, replace the system board.
3,4	Recovery image found but invalid	Flash latest BIOS version. If problem persists, replace the system board.
3,5	Power-rail failure	EC ran into power sequencing failure. If problem persists, replace the system board.

Camera status light: Indicates whether the camera is in use.

- Solid white—Camera is in use.
- Off—Camera is not in use.

Caps Lock status light: Indicates whether Caps Lock is enabled or disabled.

- Solid white—Caps Lock enabled.
- Off—Caps Lock disabled.

Updating the BIOS in Windows

Steps

1. Go to www.dell.com/support.
2. Click **Product support**. In the **Search support** box, enter the Service Tag of your computer, and then click **Search**.
 **NOTE:** If you do not have the Service Tag, use the SupportAssist feature to automatically identify your computer. You can also use the product ID or manually browse for your computer model.
3. Click **Drivers & Downloads**. Expand **Find drivers**.
4. Select the operating system installed on your computer.
5. In the **Category** drop-down list, select **BIOS**.
6. Select the latest version of BIOS, and click **Download** to download the BIOS file for your computer.
7. After the download is complete, browse the folder where you saved the BIOS update file.
8. Double-click the BIOS update file icon and follow the on-screen instructions.
For more information, see knowledge base article [000124211](https://www.dell.com/support/000124211) at www.dell.com/support.

Updating the BIOS using the USB drive in Windows

Steps

1. Follow the procedure from step 1 to step 6 in [Updating the BIOS in Windows](#) to download the latest BIOS setup program file.
2. Create a bootable USB drive. For more information, see the knowledge base article [000145519](https://www.dell.com/support/000145519) at www.dell.com/support.
3. Copy the BIOS setup program file to the bootable USB drive.
4. Connect the bootable USB drive to the computer that needs the BIOS update.
5. Restart the computer and press **F12**.
6. Select the USB drive from the **One Time Boot Menu**.
7. Type the BIOS setup program filename and press **Enter**.
The **BIOS Update Utility** appears.
8. Follow the on-screen instructions to complete the BIOS update.

Backup media and recovery options

It is recommended to create a recovery drive to troubleshoot and fix problems that may occur with Windows. Dell proposes multiple options for recovering Windows operating system on your Dell PC. For more information, see [Dell Windows Backup Media and Recovery Options](#).

WiFi power cycle

About this task

If your computer is unable to access the internet due to WiFi connectivity issues a WiFi power cycle procedure may be performed. The following procedure provides the instructions on how to conduct a WiFi power cycle:

 **NOTE:** Some ISPs (Internet Service Providers) provide a modem/router combo device.

Steps

1. Turn off your computer.
2. Turn off the modem.
3. Turn off the wireless router.
4. Wait for 30 seconds.
5. Turn on the wireless router.
6. Turn on the modem.
7. Turn on your computer.

Drain residual flea power (perform hard reset)

About this task

Flea power is the residual static electricity that remains in the computer even after it has been powered off and the battery is removed.

For your safety, and to protect the sensitive electronic components in your computer, you are requested to drain residual flea power before removing or replacing any components in your computer.

Draining residual flea power, also known as a performing a "hard reset", is also a common troubleshooting step if your computer does not power on or boot into the operating system.

To drain residual flea power (perform a hard reset)

Steps

1. Turn off your computer.
2. Disconnect the power adapter from your computer.
3. Remove the base cover.
4. Remove the battery.
5. Press and hold the power button for 20 seconds to drain the flea power.
6. Install the battery.
7. Install the base cover.
8. Connect the power adapter to your computer.
9. Turn on your computer.



 **NOTE:** For more information about performing a hard reset, see the knowledge base article [000130881](#) at www.dell.com/support.

Getting help and contacting Dell

Self-help resources

You can get information and help on Dell products and services using these self-help resources:

Table 10. Self-help resources

Self-help resources	Resource location
Information about Dell products and services	www.dell.com
My Dell app	
Tips	
Contact Support	In Windows search, type <code>Contact Support</code> , and press Enter.
Online help for operating system	www.dell.com/support/windows
Access top solutions, diagnostics, drivers and downloads, and learn more about your computer through videos, manuals and documents.	Your Dell computer is uniquely identified by a Service Tag or Express Service Code. To view relevant support resources for your Dell computer, enter the Service Tag or Express Service Code at www.dell.com/support . For more information on how to find the Service Tag for your computer, see Locate the Service Tag on your computer .
Dell knowledge base articles for a variety of computer concerns	<ol style="list-style-type: none"> 1. Go to www.dell.com/support. 2. On the menu bar at the top of the Support page, select Support > Knowledge Base. 3. In the Search field on the Knowledge Base page, type the keyword, topic, or model number, and then click or tap the search icon to view the related articles.

Contacting Dell

To contact Dell for sales, technical support, or customer service issues, see www.dell.com/contactdell.

 **NOTE:** Availability varies by country/region and product, and some services may not be available in your country/region.

 **NOTE:** If you do not have an active Internet connection, you can find contact information about your purchase invoice, packing slip, bill, or Dell product catalog.