

User's Manual

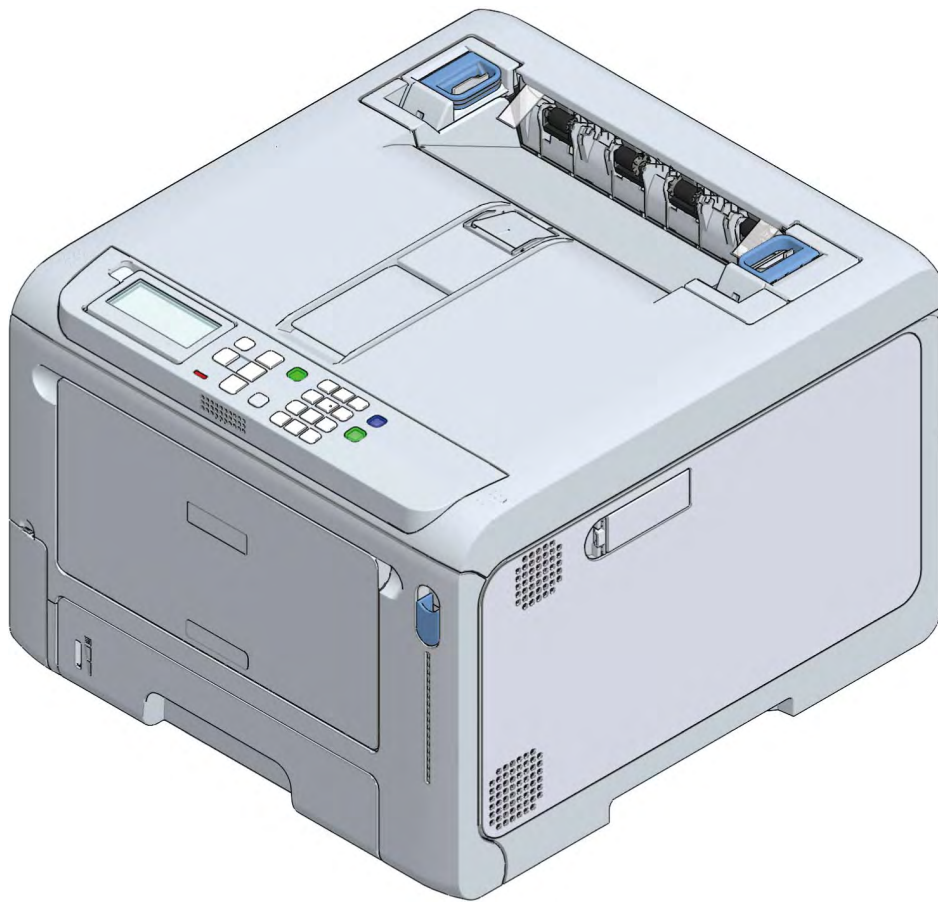

Table of Contents

1. Getting started	6	Loading paper	72
Safety precautions.....	7	Procedure for loading paper	72
General cautions	8	Applicable paper.....	72
Preface	10	Inapplicable paper	74
Trademarks	11	Paper precautions by type.....	74
About this manual.....	12	Paper applicable to each tray	76
About the description.....	12	Loading paper in Tray 1.....	76
Features of this machine.....	14	Loading paper in Tray 2/3/4 (Optional).....	78
2. Connecting to the PC after preparing this machine	15	Loading paper in the MP tray	80
Installation	16	Setting paper information on the operator panel	81
Installation environment	16	Storing paper.....	83
Installation space.....	16	Setting the output bin	84
Unpacking	18	Output tray.....	84
Checking accessories	20	Rear output tray.....	85
Installing the starter toner cartridge.....	21	Checking the configuration	86
Installing options.....	22	Printing the menu map (configuration).....	86
Installing the wireless LAN module.....	22	Confirming on the operator panel	87
Installing the expansion tray unit	24	How to use levers L1 and L2	88
Installing the dedicated caster stand	27	4. Changing settings from the operator panel.....	90
Connecting the power cord	33	Parts identification of the operator panel	91
About the power supply	33	Adjusting the display orientation	92
Loading paper in the tray	34	Inputting text.....	93
Connecting via a wired LAN.....	36	Changing settings	94
Connecting the LAN cable.....	36	Setting menu display	94
Setting the IP address, etc.	36	Setting with the short menu (Fn key).....	94
Connecting via a wireless LAN	41	Adjusting the buzzer volume	97
Connection form	41	Setting the power save function.....	98
Connecting via an access point (Infrastructure)	42	Setting the time that elapses before entering the power save mode	98
Connecting directly with this machine (AP mode)	53	Setting the time that elapses before entering the sleep mode.....	98
Connecting via USB	58	Restrictions of the power save function	99
Installing software on a PC	59	Turning off the power automatically (Auto Power Off)	99
For Windows	59	Setting the time that elapses before entering the auto power off mode.....	101
For macOS.....	63	Menu list.....	102
Setting the printer driver	64	5. Printing	130
3. Basic operations	67	Printing from a PC.....	131
Parts identification	68	For Windows PCL printer driver	131
Front.....	68	For Windows PS printer driver.....	132
Inside the main unit	69	For macOS.....	132
Back	70	Screens and functions of the printer driver ...	133
Turning the power on/off	71	Windows PCL printer driver.....	133
Turning the power on	71	Windows PS printer driver	135
Turning the power off	71	macOS printer driver	137

How to open the printer folder	142	Printing with frequently used settings registered in the printer driver	183
Printing on various types of paper.....	143	Printing data stored in this machine	185
Printing on envelopes	143	Printing data from a USB memory	185
Printing on labels	145	Printing QR codes or barcodes	187
Printing on long paper	146	Printing PS errors	188
Printing on irregular-sized paper (custom size) 148		Editing margins.....	188
Printing methods	151	Correcting the print position of the tray.....	189
Printing one sheet at a time manually	151	Printing with print data encrypted and password set (Private Print)	190
Enlarging/Reducing to fit the specified media size	152	Canceling the printing	192
Printing by enlargement/reduction.....	153		
Printing only the cover from another tray.....	153	6. Management of this machine.....	194
Booklet printing.....	154	Admin password.....	195
Printing a poster by dividing a document.....	155	Checking the factory default admin passwords 195	
Inserting and printing a watermark text (watermark)	156	Inputting the factory default admin passwords 197	
Printing overlaid text or logos (overlay printing) 157		Changing the admin password	198
Outputting to a file without printing on paper ... 158		Changing settings of Admin Setup.....	200
Printing frequently used documents without using a PC	159	Web page (Managing this machine from a PC)	201
Printing an email attachment	161	Opening the web page	201
Printing in economy mode.....	162	Logging in as an administrator	201
Printing on both sides of paper.....	162	Changing admin password (Web page)	202
Printing in the toner save mode.....	162	Checking/Changing the state of this machine . 203	
N-in-1 printing.....	164	Saving configurations	204
Printing as an image (image).....	165	Communication encryption (SSL/TLS)	205
Color setup	166	Using IPP	207
Printing color data in monochrome	166	Communication encryption (IPSec)	208
Color matching in the printer driver	167	Using the access control function (IP filter) with the IP address	209
Simulating print results	168	Using the access control function with the MAC address.....	210
Printing with color separation	169	Notifying errors via e-mail.....	210
Adjusting registration manually.....	169	Using SNMPv3	211
Adjusting the density manually	170	Using IEEE802.1X (Wired LAN)	211
Adjusting the color balance (density).....	170	Setting IEEE802.1X (Wireless LAN).....	213
Changing mono print mode	171	Connecting to a wireless LAN (WPA/WPA2-EAP)	214
Adjustment with utilities	171	Setting the LDAP server.....	215
Refining your finishing	172	Setting E-mail receiving (Web page)	216
Printing sharper photos	172	Setting the power save mode (Web page)	216
Printing with the specified print resolution	172	Setting the sleep mode (Web page)	217
Printing by correcting fine lines.....	173	Setting "Auto Power Off" (Web page).....	217
Printing by specifying the font to use	174	Copying the setup information of this machine to other devices	217
Changing black finishing.....	176	Setting items of the web page	219
Blurring white streaks between text and background (black overprint).....	177	User restriction (Access control)	225
Inconspicuous white streaks in color superposition (trapping function)	177	Preparations (For the administrator).....	225
Useful functions.....	179	Logging into this machine.....	232
Printing with multiple pages sorted into one complete set (Collate)	179	Printing from a PC	233
Printing from the last page of your document .. 180		Registering IC card information	235
Printing by automatically selecting a tray for the specified paper	180	Initializing the settings	237
Switching tray automatically at running out of paper	181	Initializing network settings.....	237
Changing default settings of the printer driver . 183		Initializing the flash memory	237

Initializing settings of this machine	238	Icon description	277
Moving/Transporting this machine	239	OKI LPR Utility	278
Moving this machine	239	Starting the OKI LPR Utility	278
Shipping this machine	239	Registering this machine with the OKI LPR utility	278
Disposal	243	Checking the state of the registered machine ..	278
7. Useful software.....	244	Transferring print data to the registered device	279
Software list.....	245	Printing the same document from multiple	279
Windows software	245	registered devices	279
macOS software	245	Opening the web page of a registered device ..	280
Applications for mobile devices	246	Automatically following the IP address of the ..	280
Installing software.....	247	registered device	280
For Windows	247	Setting the port number of the web page for the ..	280
For macOS	248	registered device	280
For mobile devices	248	Sending files to this machine registered with the ..	281
Monitoring Tool (Windows)	249	OKI LPR utility	281
Registering the printer	249	Deleting unnecessary print data	281
Updating the printer software	250	Uninstalling OKI LPR utility.....	281
Updating the printer's firmware.....	251	Network Card Setup Utility (macOS)	282
Changing settings of Monitoring Tool	252	Setting the IP address	282
Deleting the printer	253	Making web settings.....	282
Troubleshooting (Monitoring Tool).....	254	Exiting the Network Card Setup utility	282
Network Extension	255	Print Job Accounting Client.....	283
Displaying properties of the printer driver	255	For Windows	283
Confirming settings of this machine.....	255	For macOS	284
Setting options automatically.....	256	8. Printing from a mobile device	286
Uninstalling Network Extension	256	Printing from a mobile device.....	287
Color Swatch Utility	257	Using the Mobile Print	287
Printing a color sample	257	AirPrint.....	288
Customizing the color sample	257	Showing troubleshooting tips on a mobile device	291
Printing a file in your desired color	258	Troubleshooting for the mobile device	292
Color Correct Utility	259	Troubleshooting for MobilePrint.....	292
Changing palette colors.....	259	Troubleshooting for AirPrint.....	292
Changing gamma values and hues	260	9. Maintenance	294
Printing with tuned color settings.....	262	Precautions for replacing consumables	295
Saving color tuning settings.....	262	Service life and replacement cycle of	296
Importing color tuning settings.....	263	consumables	296
Deleting color tuning settings	263	Toner cartridge	296
PS Gamma Adjuster.....	265	Image drum	296
Registering a gamma adjuster name.....	265	Replacing the black(K) toner cartridge and the ..	298
Printing with registered halftone	266	waste toner box	298
Configuration Tool	267	Replacing the toner cartridge (C/M/Y)	301
Registering this machine	267	Replacing the image drum	303
Starting the Configuration Tool.....	267	Service life and replacement cycle of	306
Checking the state of this machine.....	267	maintenance parts.....	306
Displaying job completion on the PC.....	268	Belt unit	306
Setting the network.....	270	Fuser unit	307
Registering ICC profiles.....	271	Replacing the belt unit.....	308
Registering forms (form overlay)	271	Replacing the fuser unit	310
Checking free space of memory/hard disk	272		
Registering the user name and password	273		
Deleting this machine	274		
Name and function of each screen	274		

Cleaning the main unit and the parts	312	The entire paper is printed in black	370
Cleaning the LED head	312	Nothing is printed	371
Cleaning the surface of the main unit	313	White streaks occur	371
Cleaning paper feed rollers (Trays 1-4)	314	The peripheral area is dirty	371
Cleaning the paper feed roller (MP tray)	315	The color of images does not come as expected	372
Cleaning the light-shielding film	319	An afterimage printed on the front edge of the paper is printed	372
Cleaning the resist roller	320	Software troubleshooting	373
Updating software	321	Troubleshooting for this machine and paper	374
For Windows	321	Troubleshooting for the machine	374
For macOS	321	Troubleshooting for the paper	378
Deleting software	322	When a power failure occurs	380
Uninstalling the Windows printer driver	322	Appendix	381
Uninstalling the macOS printer driver	322	Specifications	382
Firmware update	324	Regulatory wireless LAN statements	384
For Windows	324	Dimensions	386
For macOS	324	Using the FAQ guide of this machine	388
10. Troubleshooting	325	Contact us	391
When an error message appears on the display	326	Menu tree	392
Error message list	327		
When paper is jammed	337		
For the error code 370 or 371	337		
For the error code 372	340		
For the error code 380	342		
For the error code 381	343		
For the error code 382 or 385	344		
For the error code 390	348		
For the error code 391, 392, 393 or 394	349		
For the error code 638	350		
Trouble with printing	355		
I cannot print	355		
Troubleshooting for wired LAN connection	356		
Troubleshooting for wireless LAN connection	356		
Troubleshooting for USB connection	360		
Troubleshooting for printing results	361		
List of troubles with printing results	361		
White streaks appear in the vertical direction ..	364		
Printing is faint in the vertical direction	364		
Printing is light	365		
White dots or lines appear	365		
Condensation occurs on printed paper	366		
Streaks appear in the vertical direction	366		
Dots and horizontal streaks appear in the paper feeding direction periodically	367		
White area is lightly stained	368		
Edges of text are blurred	368		
When envelopes or coated paper is printed, the whole area is thinly stained	369		
Toner comes off when rubbed	369		
Uneven Gloss	369		
Point stains appear	370		
Stains are printed	370		



1

Getting started

















Safety precautions.....	7
General cautions	8
Preface	10
Trademarks	11
About this manual.....	12
Features of this machine.....	14

Safety precautions



Read this manual for your safety before using the product.

 WARNING	Mishandling due to ignoring this display may cause death or serious injury.
 CAUTION	Mishandling due to ignoring this display may cause personal injury.

General cautions

 WARNING	
	Do not touch the safety switch inside the machine. Doing so may cause electric shock when high voltage occurs. In addition, gears can rotate, which may result in personal injury.
	Do not use an inflammable spray near the machine. Doing so may cause a fire since there is an area heating up within the machine.
	Unplug the power cord from the outlet and contact your dealer if the cover becomes abnormally hot, emits smoke, smells strange, or makes an abnormal noise. Failure to do so may cause fire.
	Unplug the power cord from the outlet and contact your dealer if water or other liquid gets into the machine. Failure to do so may cause fire.
	If paper clips or other foreign objects enter the machine, disconnect the power plug from the outlet and remove foreign objects if any. Failure to do so may cause electric shock, fire or injury.
	Do not disassemble the machine or perform operations other than those specified in the User's Manual. Doing so may cause electric shock, fire or injury.
	Unplug the power cord from the outlet and contact your dealer if the machine is dropped or the cover is damaged. Failure to do so may cause electric shock, fire or injury.
	Periodically disconnect the power plug from the outlet and clean the base of the prongs and between the prongs. Leaving the power plug inside the outlet for a long period of time may cause a fire due to short circuit caused by collection of dust at the base of the prongs.
	Do not clean up spilled toner using an electric vacuum cleaner. When spilled toner is cleaned up using an electric vacuum cleaner, a fire may be caused due to sparks from electrical contacts. If toner is spilled on the floor, wipe the toner up carefully using a damp cloth to prevent toner scattering.
	Do not insert objects into the air vents. Doing so may cause electric shock, fire or injury.
	Do not place any containers like cups containing water on the machine. Doing so may cause electric shock or fire.
	Make sure that no urine from pets on top of the printer wet or enter this machine. Failure to do so may cause electric shock or fire.
	Take care when touching the fuser unit. Failure to do so may cause burns.
	Do not throw the image drum, toner cartridge or waste toner box into fire. Doing so may cause burns due to dust explosion.
	Do not connect the power cord, cables and ground wire other than those specified in the User's Manual. Doing so may cause a fire.
	Operations using an uninterruptible power supply (UPS) or an inverter are not guaranteed. Do not use an uninterruptible power supply or inverter. Doing so may cause a fire.

 **CAUTION**

	Do not approach the paper discharger when the power is on or during printing. Doing so may cause injury.
	Do not touch a broken display. Doing so may cause injury. If any liquid (liquid crystal) leaking from the display gets into the eyes or mouth, wash it off promptly with a large quantity of water. Consult a physician as necessary.
	Do not disassemble or forcibly open the image drum, toner cartridge or waste toner box. Doing so may scatter the toner, which may be inhaled by people or may stain clothes or hands.

NOTE!

This product is not intended for use in the immediate visual field on the display work place. To avoid disturbing reflections on the display work place, this product shall not be placed in the immediate field of vision.

Preface

• EMERGENCY FIRST AID

Take care with toner powder:



If swallowed, give small amounts of cold water and seek medical attention. DO NOT attempt to induce vomiting.

If inhaled, move the person to an open area for fresh air. Seek medical attention.

If it gets into the eyes, flush with large amounts of water for at least 15 minutes keeping eyelids open. Seek medical attention.

Spillages should be treated with cold water and soap to help reduce risk of staining skin or clothing.

• ENVIRONMENTAL INFORMATION



Trademarks

OKI is a registered trademark of Oki Electric Industry Co., Ltd.

ENERGY STAR® is a trademark of the United States Environmental Protection Agency.

Microsoft, Windows, Windows Server and Internet Explorer are registered trademarks or trademarks of Microsoft Corporation in the United States and other countries.

Apple, Mac, macOS, iPad, iPhone, iPod, iPod Touch and Safari are registered trademarks of Apple Inc. in the United States and other countries.



AirPrint and the AirPrint logo are trademarks of Apple Inc.

Google, Google Chrome, Android and Gmail are trademarks or registered trademarks of Google LLC.

iOS is a trademark of Cisco.

Adobe, Illustrator, Photoshop, PostScript and Reader are registered trademarks or trademarks of Adobe Systems Incorporated in the United States and other countries.

Wi-Fi is a registered trademark of Wi-Fi Alliance.

Other product names and brand names are registered trademarks or trademarks of their proprietors.

	<p>As an ENERGY STAR® Program Participant, the manufacturer has determined that this product meets the ENERGY STAR® guidelines for energy efficiency.</p> <p>Target countries of the ENERGY STAR® program are the United States, Canada and Japan.</p> <p>It is not applicable to other countries.</p>
	<p>This product complies with the requirements of the Council Directives 2014/30/EU (EMC), 2014/35/EU(LVD), 2014/53/EU (RED), 2009/125/EC (ErP) and 2011/65/EU(RoHS), as amended where applicable, on the approximation of the laws of the member states relating to Electromagnetic Compatibility, Low Voltage, Radio Equipment, Energy related Products and Restriction on the use of certain Hazardous Substances in electrical and electronic equipment.</p>

The following cables were used to evaluate this product for EMC directive 2014/30/EU compliance, and configurations other than this may affect that compliance.

CABLE TYPE	LENGTH (METER)	CORE	SHIELD
Power	1.8	X	X
USB	5.0	X	✓
LAN	10.0	X	X

The simplified EU declaration of conformity

Hereby, Oki Electric Industry Co., Ltd. declares that the radio equipment type "AW-CM382" is in compliance with Directive 2014/53/EU.

The full text of the EU declaration of conformity is available at the following internet address:

<https://www.oki.com/eu/printing/support/declaration-of-conformity>

About this manual

This section lists a variety of information about this manual. Please read this manual before using the machine.



- Depending on the target region or country, specifications and functions of the product may differ from those described in the manual. Please check the menu items and default settings with the device you are using.

Manual structure

- Basic Operation Guide (PDF)...included on the DVD enclosed with this machine.
- User's Manual (PDF)...available on the website.
- Online Manual...available on the website.

About this manual

- The reproduction of this manual, in whole or in part, without permission is strictly prohibited.
- The content of this manual may be changed without a prior notice in the future.
- Efforts have been exerted to make the content of this manual as complete as possible. However, should you notice any errors, omissions or other problems, contact the retail store where you made the purchase.
- Notwithstanding the foregoing, we shall not have any liability in regard to any operational effect related to the instructions contained in this manual.

Copyrights

All rights belong to Oki Electric Industry Co., Ltd. This manual may not be reproduced, transcribed or translated without permission. Be sure to obtain the written approval from Oki Electric Industry Co., Ltd.

© 2020 Oki Electric Industry Co., Ltd.

About the description

This section describes the marks, symbols, abbreviations and illustrations used in this manual.



- This manual uses screens of the following operating systems unless otherwise specified.
For Windows: Windows 10
For macOS: macOS 10.15
- Sometimes, the model name is written as [OKI Printer].
- Depending on the used OS, model and version, the description in this manual may differ.

About marks

This manual uses the following marks.

Mark	Meaning
	Indicates cautions and restrictions for the correct operation of this machine. Be sure to read them to avoid misoperation.
	Indicates useful tips and references on how to use this machine. We recommend you read them.
	Indicates reference items. Please read them to learn the detailed information.
	Indicates the related items. Please read them to learn the relevant information.

About symbols

This section describes the symbols used in this manual and their meanings.

Symbol	Meaning
« »	Indicates buttons/keys on the operator panel of this machine. Indicates keys on the PC keyboard.
[]	Indicates menu names, item names, options, etc. displayed on the display. Indicates menus, windows and dialog box names displayed on the PC screen. They can be clearly distinguished in the description and procedure illustration.
" "	Indicates messages and input texts displayed on the display. Indicates file names on the PC. Indicates item titles of link destinations.
-	Indicates the menu path of this machine or the PC.

Features of this machine

- **Installable in restrained space**

As the machine is compact, the space between both sides of this machine and the wall can be as small as 20 mm. (When the optional caster stand is not installed)

- **Easy maintenance with full front access**

You can replace consumables and maintenance parts, and clear a paper jam from the front side.

- **An increased service life of the machine and consumables**

The service life of this machine and the image drum has been extended in comparison with existing models.

- **Immediate start of printing thanks to short warm-up time**

The warm-up time of this machine has been shortened in comparison with conventional models.

- **Massive printing possible with the extension tray**

Up to three extension trays can be installed.

- **Easy troubleshooting by watching the display**

The troubleshooting hint is displayed together with illustrations on the display. You can solve problems by following the on-screen instructions.

- **Easy setting change by shortcut menus**

Menu items can be displayed easily by pressing the «Fn» key and then inputting a number.

 [Setting with the short menu \(Fn key\)\(P.94\)](#)

- **Easy update by using the Monitoring Tool**

You can update the firmware and the software easily by using the Monitoring Tool.

- **Easy mobile printing and initialization with the NFC and app**

You can print and initialize this machine by using the specialized application from your smartphone, tablet or other mobile devices.

 [Applications for mobile devices\(P.246\)](#)

2**Connecting to the PC after preparing this machine**

Installation	16
Unpacking	18
Checking accessories	20
Installing the starter toner cartridge.....	21
Installing options.....	22
Connecting the power cord	33
Loading paper in the tray	34
Connecting via a wired LAN.....	36
Connecting via a wireless LAN	41
Connecting via USB	58
Installing software on a PC	59

Installation

Installation environment

Install this machine in the following environment.

Ambient temperature: 10°C to 32°C

Ambient humidity: 20% to 80% RH (relative humidity)

Maximum wet-bulb temperature: 25°C



- Make sure there is no condensation. Failure to do so may cause a malfunction.
- To install this machine in a location where the ambient humidity is 30% RH or less, use a humidifier or static prevention mat.
- Depending on the installation environment, the operating noise of this machine may cause concern. If you are concerned about the operating noise, we recommend that you install this machine in an isolated location or a separate room.
- Do not install this machine near any devices in which combustion takes place. Doing so may cause lighter printing.

WARNING

- Do not install this machine close to high-temperature locations or naked flames.
- Do not install in locations where chemical reactions occur (e.g. laboratories).
- Do not install this machine close to combustible solutions such as alcohol and thinners.
- Do not install this machine within the reach of children or infants.
- Do not install this machine in an unstable location (e.g. unsteady table or sloping surface).
- Do not install this machine in a humid or dusty location, or in a location exposed to direct sunlight.
- Do not install this machine in an environment with salt air, corrosive gas, NOx, or SOx.
- Do not install this machine in locations with major vibration.
- Do not install this machine in locations where its air vents are blocked.

CAUTION

- Do not directly install this machine on shaggy rugs or carpets.
- Do not install this machine in locations with poor air circulation or ventilation like in a sealed room.
- Ensure proper ventilation when it is used for a long time in a small room.
- Keep this machine away from strong magnetic fields and sources of noise.
- Keep this machine away from monitors and TVs.
- When moving this machine, stand at the front and back and hold the handle at the bottom of the machine.

Installation space

Install this machine on a flat desk which is larger than the bottom of the machine.

Allow sufficient space around this machine as shown in the following figures.

- Plan view (When the optional caster stand is not installed)

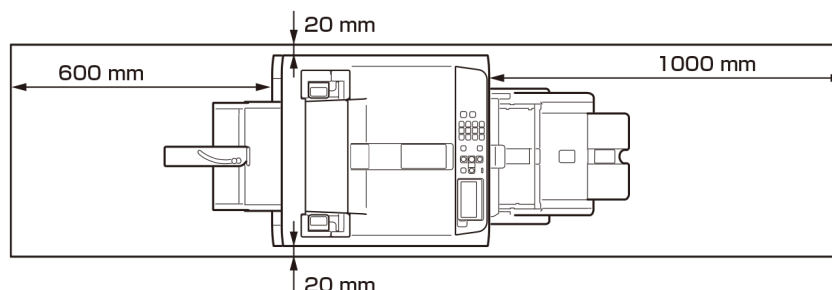

- Side view (When the rear output tray is used)

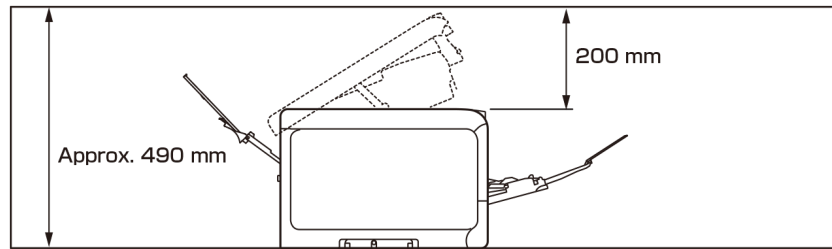

- Depending on the installation environment, the temperature inside this machine may rise and the printing speed may slow down.

- Side view (When the rear output tray is closed and a cable with angled connector is used)

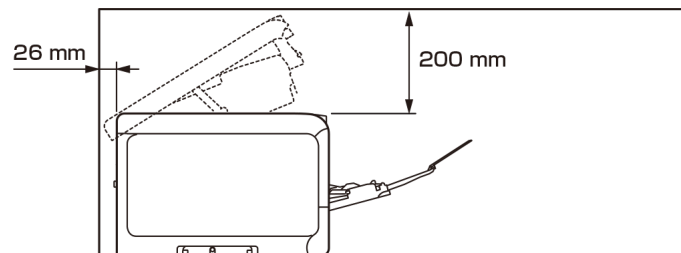

- Depending on the installation environment, the temperature inside this machine may rise and the printing speed may slow down.
- Do not place curtains, paper or other flammable objects on the back of this machine.

Unpacking



Doing so may cause injury.



This machine weighs approx. 30 kg, so be sure to have it lifted by at least 2 persons.



- Be sure to use the consumables/maintenance items supplied with this machine first. If you install the consumables/maintenance items other than those supplied first, the lifespan may not be displayed correctly or the accessories may not be usable later.
- Because image drums (green parts) can easily get damaged, handle with adequate care.
- Do not expose the image drum to direct sunlight or strong light exceeding approx. 1,500 lux. Do not leave it for more than 5 minutes even under room lighting.
- Do not expose the removed fuser unit to direct sunlight or strong light exceeding approx. 1,500 lux. Do not leave it uncovered for more than 5 minutes even under room lighting.
- The packing box and buffer material are required when shipping this machine. Do not discard them, but store them safely.

1 Open the packing box and take out the accessories and buffer material.

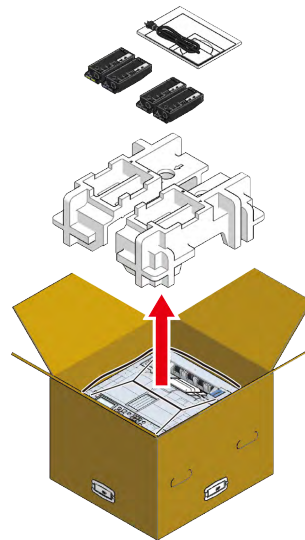

2 Remove the packing case and take out this machine from the plastic bag.

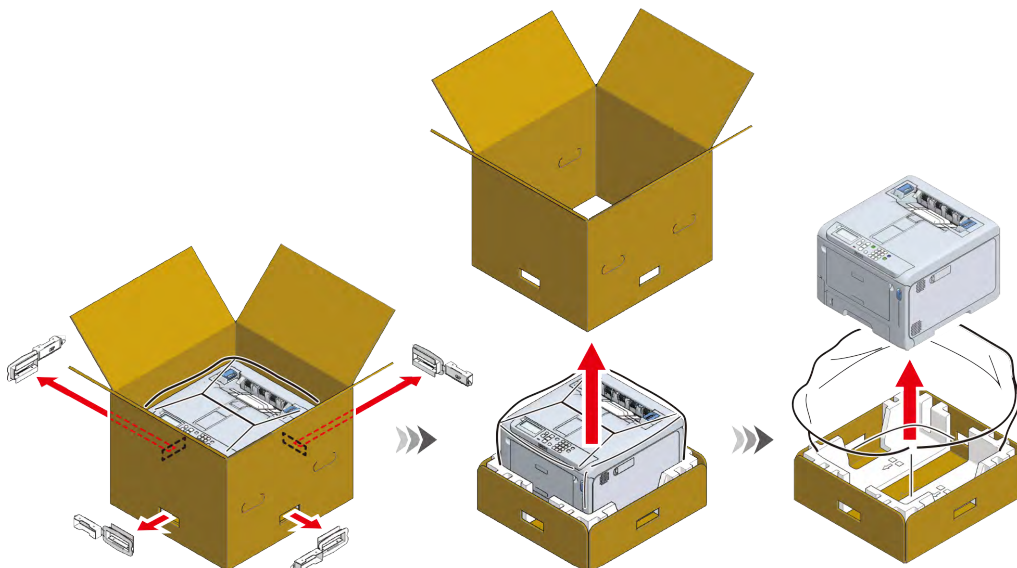

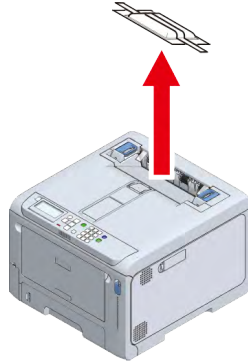

- 3 Lift this machine and place it at the installation site.
- 4 Remove the drying agent on the top of this machine.



- To use the optional expansion tray, see "[Installing options](#)(P.22)".

Checking accessories

Make sure that you have all the following accessories.

 CAUTION	Doing so may cause injury.	
This machine weighs approx. 30 kg, so be sure to have it lifted by at least 2 persons.		



- See "[Unpacking\(P.18\)](#)" for the unpacking method.



- Be sure to use the consumables enclosed with this machine first. If you install consumables other than the accessories first, the service life may not be displayed correctly, or the accessories may not be usable later.

- Main unit



- By default, an image drum and a waste toner box are installed in the main unit.

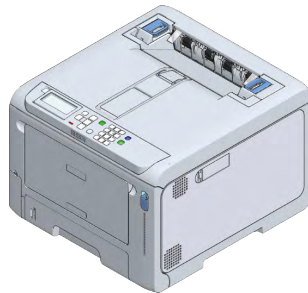

- 4 starter toner cartridges (black, cyan, magenta, and yellow)



- Setup Guide

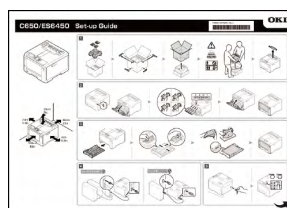

- DVD



- Power cord



- The LAN cable and USB cable are not included. Please prepare a cable separately according to the connection environment.

 [Connecting via a wired LAN\(P.36\)](#)

 [Connecting via USB\(P.58\)](#)

Installing the starter toner cartridge



- When you use this machine for the first time, install the included starter toner cartridge. If an optional toner cartridge is installed and used first, you may not be able to use the starter cartridge later.
- Do not install a starter toner cartridge that has been used in another machine. The remaining toner may not be displayed correctly.

- 1 Pull the front cover open lever (blue) to open the front cover.

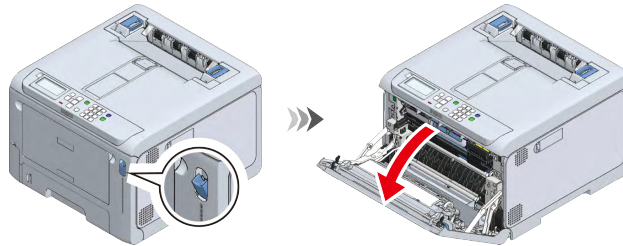

- 2 Take the black(K) starter toner cartridge out of the bag, and shake it several times vertically or horizontally.



- 3 Install the black(K) starter toner cartridge in the machine.

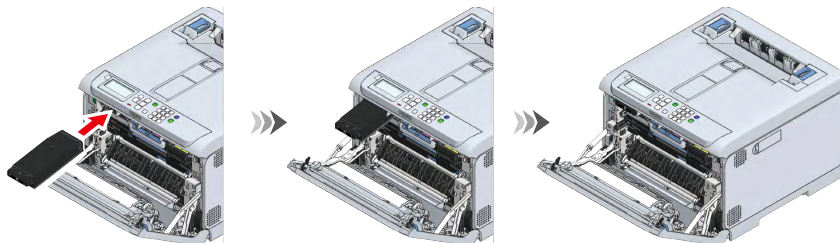

- 4 Install the starter toner cartridge (C/M/Y) in the same way as the black(K) starter toner cartridge.

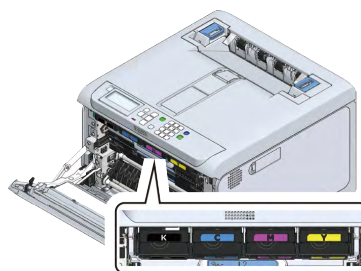

- 5 Close the front cover firmly with both hands.

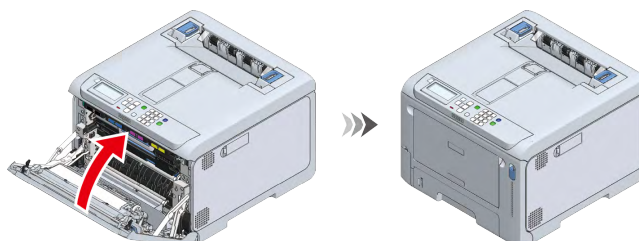

Installing options

This section explains the installation of options. If no option is installed, proceed to "[Connecting the power cord\(P.33\)](#)".

The following options are available.



- Be sure to turn off the power and unplug the power cord and cables before installing any options. If an option is installed with the power on, the main unit and the option may be damaged.

- Wireless LAN module

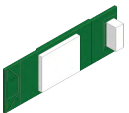
	Description
	Install it when you want to use this machine via a wireless LAN.

- Expansion tray unit

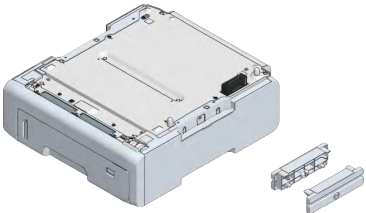
	Description
	Install it to increase the quantity of paper that can be loaded in this machine. Up to 3 levels can be expanded.

- Dedicated caster stand

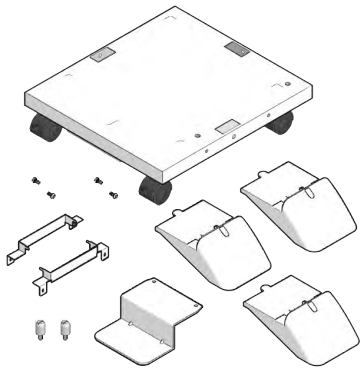
	Description
	With it installed, the machine is easier to move. After moving, fix with a stopper.



- After mounting the optional expansion tray unit, install the software on your PC, and set the options from the printer driver. See "[Setting the printer driver\(P.64\)](#)".

Installing the wireless LAN module

Install it when you want to use this machine via a wireless LAN. After installation, it is required to follow the procedure to enable the wireless LAN module.

This section describes the procedure of installing the wireless LAN module and enabling it from the operator panel.

Ethernet and wireless LAN can be used simultaneously on different networks.

Model: 45830222

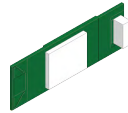

1 Turn off this machine and unplug the power cord.



- If you install it with the power on, the main unit or wireless LAN module may be damaged.

[Turning the power off\(P.71\)](#)

2 Open the wireless LAN module cover on the side of this machine.

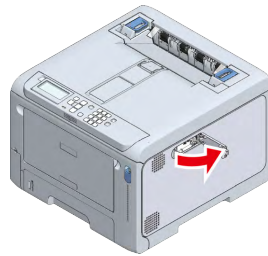

3 Pull out the connector and insert it into the wireless LAN module.

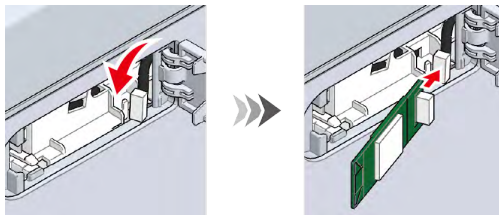

4 Insert the wireless LAN module into this machine.

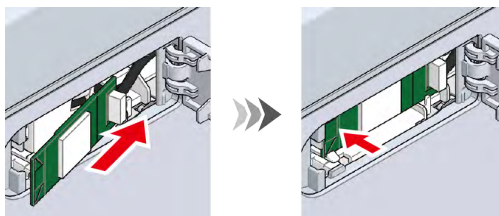

5 Close the wireless LAN module cover.

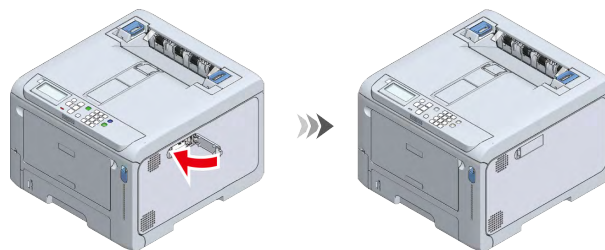

6 Connect the power cord to this machine.

[Connecting the power cord\(P.33\)](#)

7 Power on this machine.

8 Press the scroll button ▼ on the operator panel several times to select [Admin Setup], and press «OK».

- 9 Input the admin password using the numeric keypad, and press «OK».
[Admin password\(P.195\)](#)
- 10 Check that [Network Setup] is selected, and press «OK».

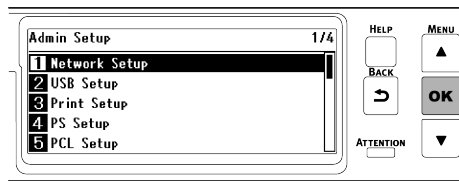

- 11 Check that [General Setup] is selected, and press «OK».

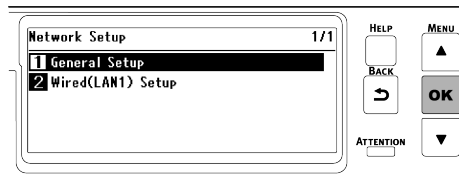

- 12 Check that [Extended Network] is selected, and press «OK».

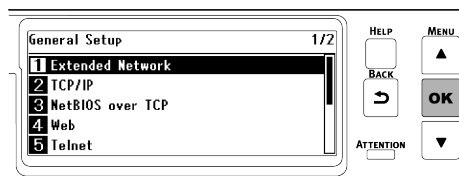

- 13 Press ▼ to select [Wireless], and press «OK».

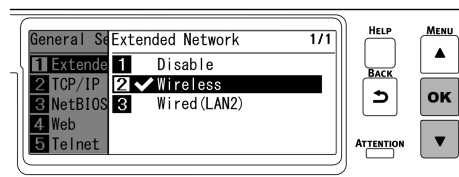

- 14 When [Are You Sure?] is displayed, check that [Yes] is selected, and press «OK».

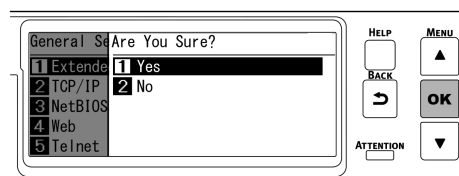

- 15 Wait until the standby screen appears as this machine restarts.

- 16 Enable [Wireless(Infrastructure)] or [Wireless(AP Mode)].

[Connecting via a wireless LAN\(P.41\)](#)



- [Wireless(Infrastructure)] and [Wireless(AP Mode)] cannot be enabled at the same time.

Installing the expansion tray unit



CAUTION

Doing so may cause injury.



This machine may fall over. Be sure to install the attached fixing parts.
 To use the dedicated caster stand, be sure to mount the anti-tip feet.

Install the expansion tray unit to increase the quantity of paper that can be loaded. After installation, set the number of trays in the printer driver.

Up to three extension trays can be installed. Be sure to install the attached fixing parts.

To install any of the three expansion trays, it is recommended to install the optional dedicated caster stand to avoid the risk of tipping. Be sure to mount the anti-tip feet.

[Installing the dedicated caster stand\(P.27\)](#)

A flat-head screwdriver is required to install the expansion tray unit.



- The packing case and buffer materials are required to ship the expansion tray. Do not discard them, but store them safely.
- When an extension tray is used to print from, if the printing position shifts, correct the printing position for each extension tray. For details, see "[Correcting the print position of the tray\(P.189\)](#)".

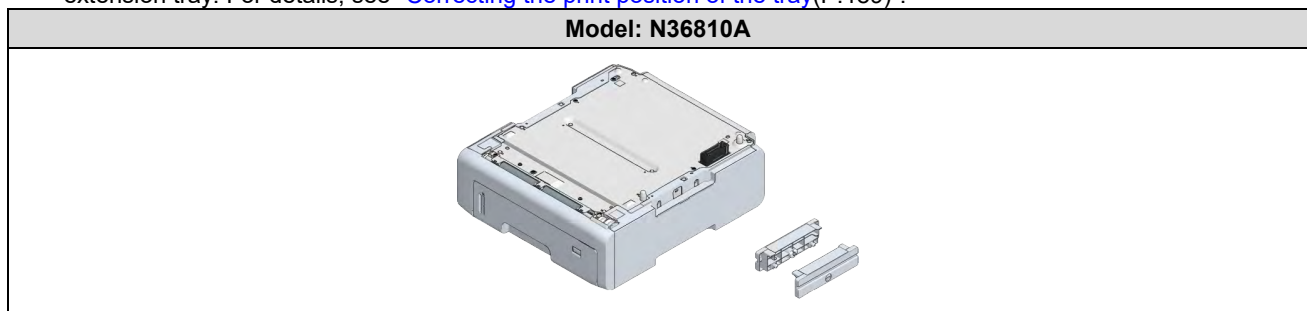

CAUTION	Doing so may cause injury.	
This machine weighs approx. 30 kg, so be sure to have it lifted by at least 2 persons.		

This section describes the installation of two expansion tray units as an example.

1 Turn off this machine and remove the power cord and all the cables.



- Be sure to turn off the power and unplug the power cord and all the cables before installing the expansion tray unit. If the expansion tray unit is installed with the power on, this machine and the expansion tray unit may be damaged.
- Installation with a cable connected may cause you to get caught in the cable and get injured.

2 Install one expansion tray.

3 Gently stack the additional expansion tray on the expansion tray installed in Step 2 so that they are aligned on the right side and front and the protrusions fit into the holes on the bottom.

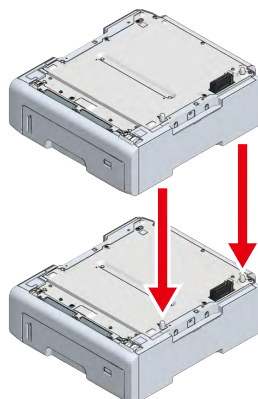

- 4 Fix the stacked expansion trays on both sides with accessories by using a flat-head screwdriver.

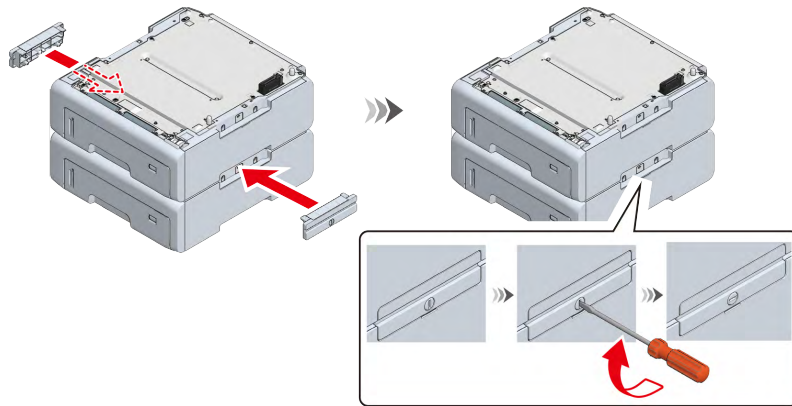

- 5 With the main unit and the expansion trays aligned on the right side and front, gently stack them so that the protrusions of the expansion tray fit into the holes on the bottom of the main unit.

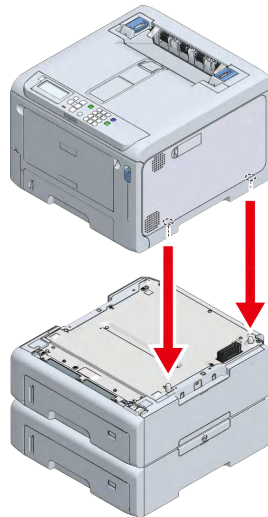

- 6 Fix the main unit and the expansion trays by using a flat-head screwdriver.

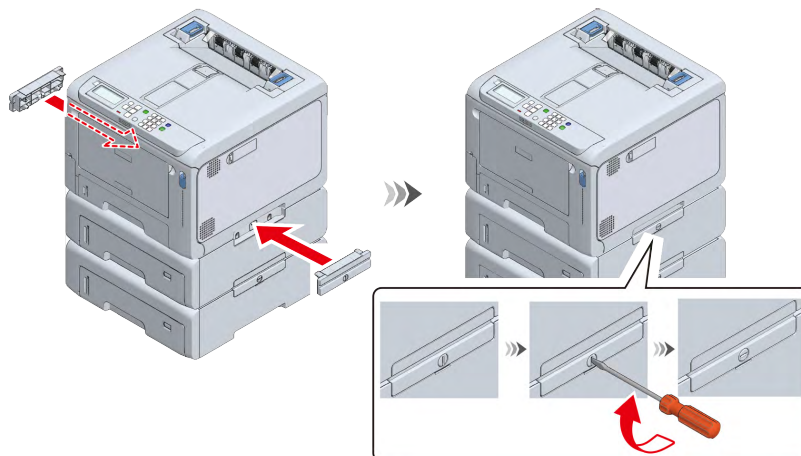

- When transporting this machine, replacing consumables or maintenance parts, or loading paper in the tray, check the following points to avoid the risk of tipping.

- Do not press on the back of this machine or the image drum basket when the output tray is open and the image drum is pulled out.

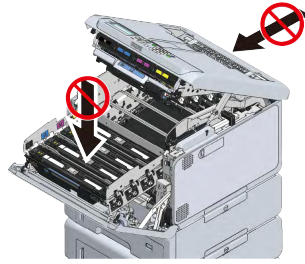

- Do not press on the cassette from above when the cassette is pulled out.

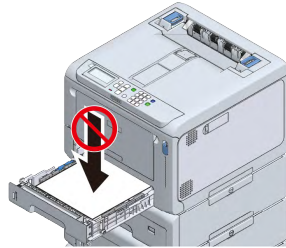

- Do not press on this machine from the back with the cassette pulled out.

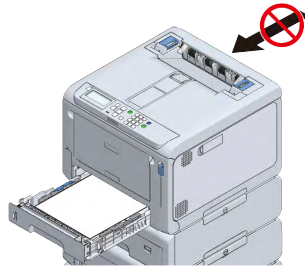

- 7 Plug in the power cord and the disconnected cable back to the main unit.
[Connecting the power cord](#)(P.33)
- 8 Power on this machine.
- 9 Press the scroll button ▼ on the operator panel several times to select [Configuration], and press «OK».
- 10 Check that [Tray Count] is selected, and press «OK».
- 11 Make sure the display shows the installed expansion tray.
- 12 After confirming the content, press «ONLINE» to return to the standby screen.
- 13 After connecting this machine to a PC and completing software installation, set the expansion tray unit in the printer driver.
[Setting the printer driver](#)(P.64)

Installing the dedicated caster stand



Doing so may cause injury.



This machine may fall over. Be sure to install the attached fixing parts.
 To install any of the three expansion trays, be sure to mount the anti-tip feet.

This is a stand with casters for moving this machine.

It also comes with anti-tip feet to avoid the risk of tipping. It is recommended to use it when the expansion tray is installed.

A Phillips-head screwdriver and a flat-head screwdriver are required to install the caster stand.



- To install any of the three expansion trays is installed, be sure to install the dedicated caster stand, the anti-tip feet and the attached fixing parts to avoid the risk of tipping.
- The packing box and buffer materials are required to ship the dedicated caster stand. Do not discard them, but store them safely.

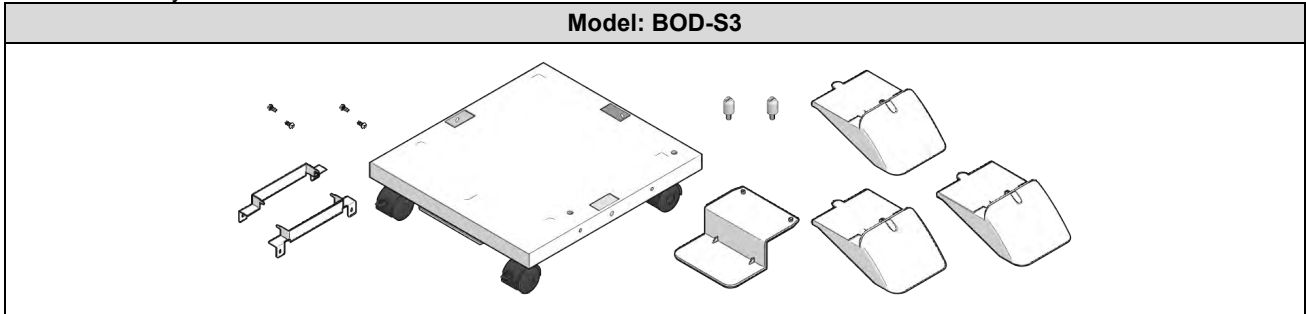

CAUTION	Doing so may cause injury.	
This machine weighs approx. 30 kg, so be sure to have it lifted by at least 2 persons.		

1 Check that you have all the parts for the dedicated caster stand.

- (1) Main unit
- (2) Anti-tip foot a
- (3) Anti-tip foot b (x 3)
- (4) Positioning pin (x 2)
- (5) Metal fixtures of the caster stand (x 2)
- (6) Screw (x 4)

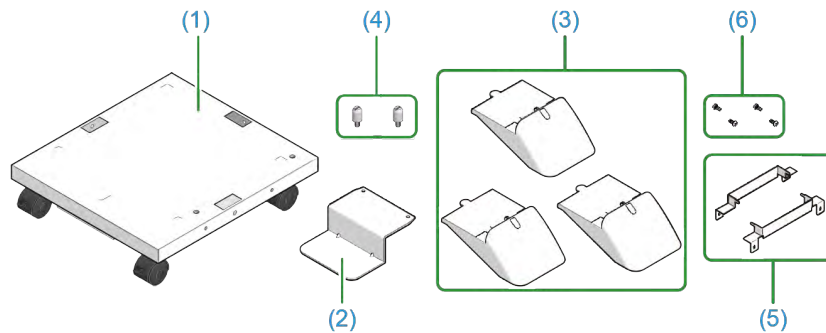

2 Mount the anti-tip foot a on the front of the dedicated caster stand.

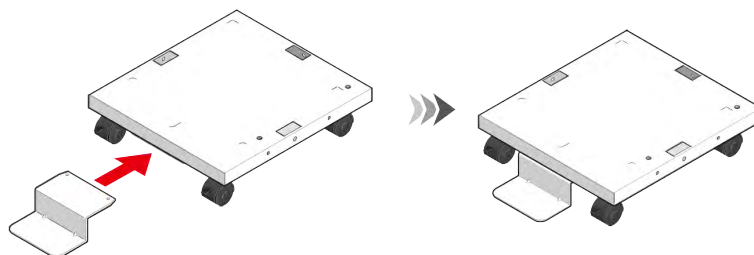

- 3 Then, mount the anti-tip foot b (x 3) to both sides and the back.

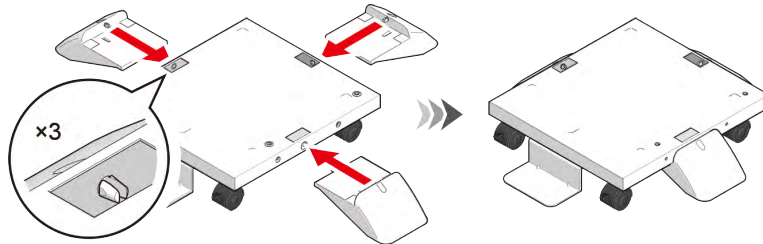

- 4 Check that the anti-tip foot a and the anti-tip foot b (x 3) are inserted in place by turning the dedicated caster stand upside down.

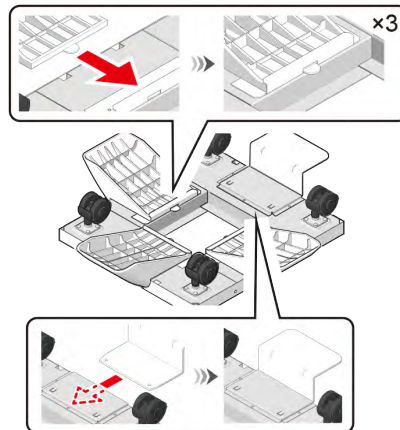

- 5 Turn the dedicated caster stand back and mount the positioning pin (x 2). Rotate to fix the positioning pin (x 2) with a flat-head screwdriver.

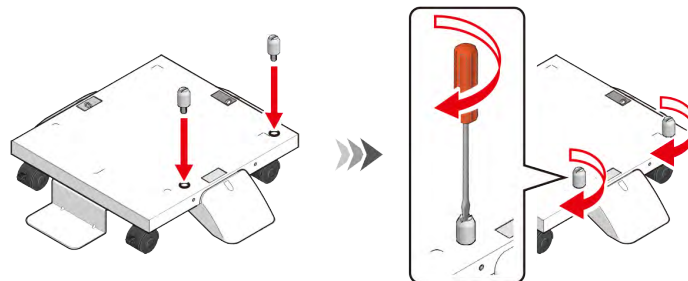

- 6 Turn off this machine and remove the power cord and all cables.



- Installation with a cable connected may cause you to get caught in the cable and get injured.

- 7 Lock the caster (2 places) to prevent the dedicated caster from moving during the installation of the main unit and the expansion tray.

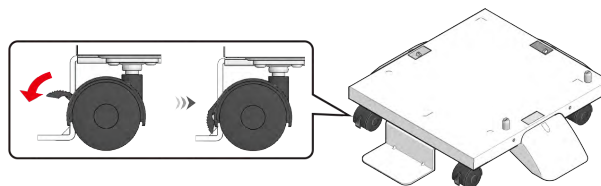

- 8** With the main unit or the expansion tray aligned with the dedicated caster on the right side and the front, gently stack them so that the positioning pins of the dedicated caster stand fit into the holes on the bottom.

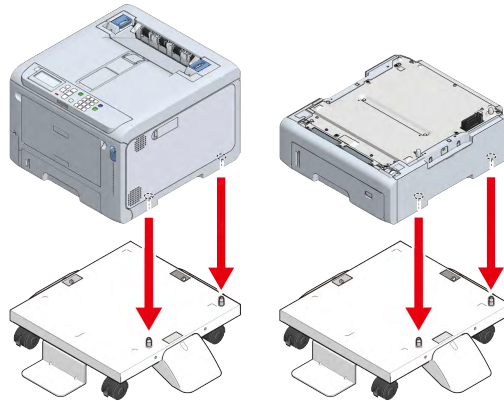

- 9** Fix the main unit or the extension tray and the dedicated caster stand with the metal fixtures (x 2) and the screws (x 4) by using a Phillips-head screwdriver. The figure shows an example of fixing the expansion tray and the dedicated caster stand.

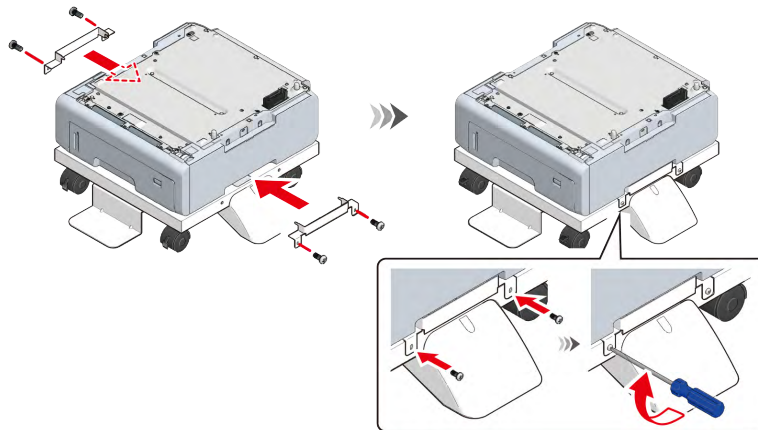

- 10** To add more extension trays, with the expansion tray already attached onto the dedicated caster stand aligned with the expansion tray to be installed on the right side and front, gently stack them so that the protrusions fit into the holes on the bottom.

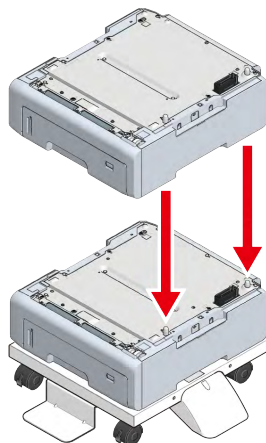

- 11** Fix the stacked expansion trays on both sides with accessories by using a flat-head screwdriver.

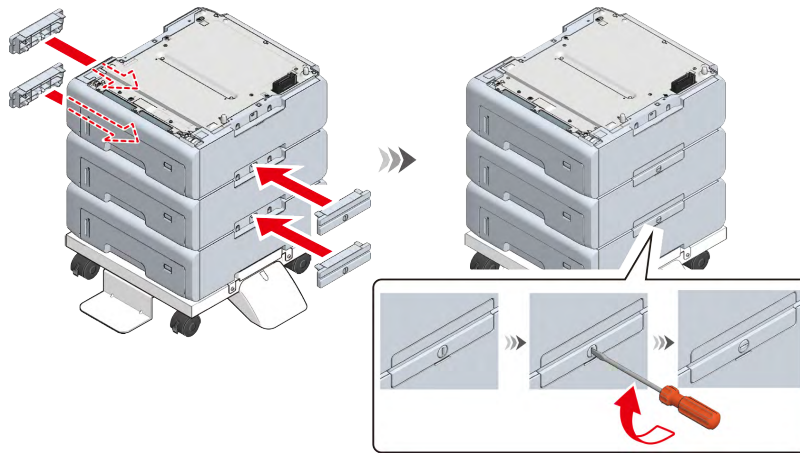

- 12** When multiple expansion trays are installed, with the main unit and the expansion trays aligned on the right side and front, gently stack them so that the protrusions of the expansion tray fit into the holes on the bottom of the main unit.

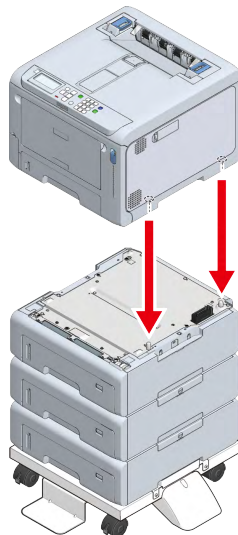

- 13** When the expansion tray is installed, fix the main unit and the expansion tray on both sides with accessories by using a flat-head screwdriver.

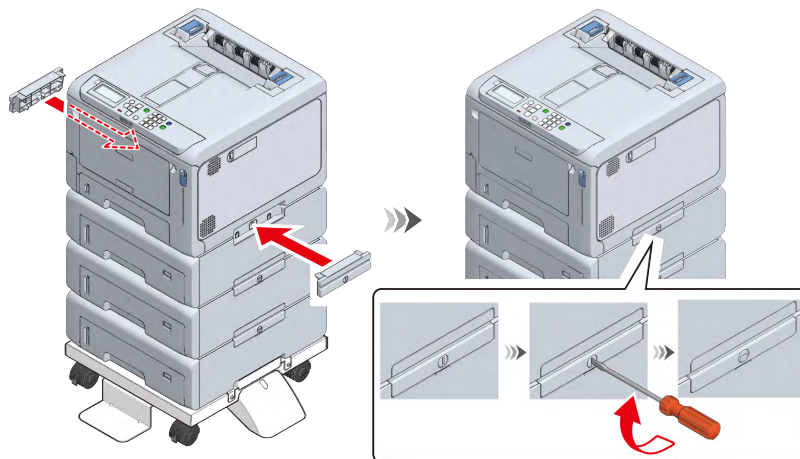

14 Before moving this machine, unlock the casters (2 places).

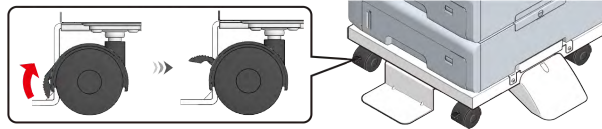

15 After moving this machine, lock the casters (2 places) to prevent accidental sliding.

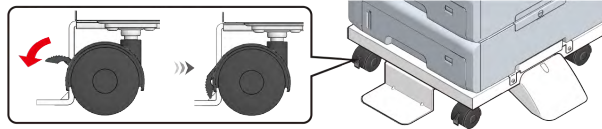

- When transporting this machine, replacing consumables or maintenance parts, or loading paper in the tray, check the following points to avoid the risk of tipping.
 - Do not press on the back of this machine or the image drum basket when the output tray is open and the image drum is pulled out.

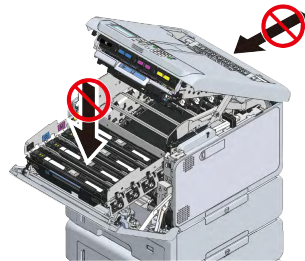

- Do not press on the cassette from above when the cassette is pulled out.

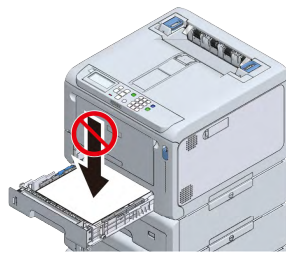

- Do not press on this machine from the back with the cassette pulled out.

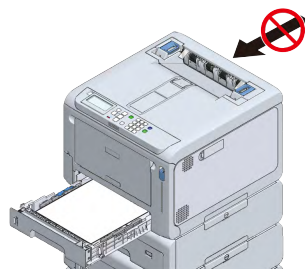

16 Plug in the power cord and the disconnected cable back to this machine.

17 Power on this machine.

When an expansion tray unit is installed, it is required to check the installation and set the printer driver.

[Setting the printer driver](#)(P.64)

Connecting the power cord

About the power supply



The power supply must meet the following requirements.

Voltage: 110 to 127V AC (Range 99 to 140V AC) / 220 to 240V AC (Range 198 to 264V AC)

Power supply frequency: 50/60 Hz \pm 2%



- If the power supply is unstable, use a voltage regulator.
- The maximum power consumption of this machine is 1,150W. Check that there is sufficient voltage capacity.
- This machine may not work properly if an uninterruptable power supply (UPS) or inverter is used. Do not use any uninterruptable power supply or inverter.

 WARNING	Doing so may cause fire or electric shock.	
<ul style="list-style-type: none"> • Be sure to turn off the power before connecting or disconnecting the power cord or ground wire. • Be sure to insert the ground wire into the dedicated ground connector. If you cannot connect to the ground, please consult your dealer. • Do not connect the ground wire to any water pipe, gas pipe, telephone ground line, lightning rod, etc. • Be sure to connect the ground wire before connecting the power cord to an outlet. Yet, be sure to disconnect the ground wire after disconnecting the power cord from the outlet. • Be sure to hold the power plug when plugging or unplugging the power cord. • Insert the power cord fully into the outlet. • Do not plug or unplug the power cord with wet hands. • Do not route the power cord wherever it could be stepped on. Also, do not place anything heavy on the power cord. • Do not bundle or tie the power cord during use. • Do not use the power cord if damaged. • Do not use any multi-outlet power strips. • Do not plug this machine and other electric devices to the same outlet. Particularly, if connected to the same outlet with air-conditionings, copiers, shredders, this machine may malfunction due to electric noise. If they have to share a same outlet, use a commercially available noise filter or noise cut transformer. • Plug the power cord that comes with this machine directly to the outlet. Do not use the power cord for other devices with this machine. • Do not use any extension cord. If you have to use an extension cord, use one with a rating of 15A or above. • If an extension cord is used, this machine may malfunction due to lower AC voltage. • Do not turn off the power or unplug the power cord during printing. • Unplug the power cord if you are not going to use the machine for a long time due to a vacation or traveling. • Do not use the power cord that comes with this machine with other devices. 		

- 1 Insert the power cable into the power connector of this machine.

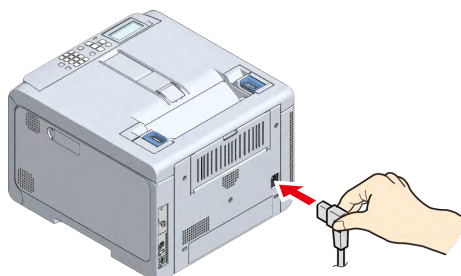

- 2 Insert the power plug into the outlet.

Loading paper in the tray

This section describes the procedure assuming that A4-sized plain paper is loaded in Tray 1. When other paper is loaded, see "[Loading paper\(P.72\)](#)".

- 1 Pull out the paper cassette.

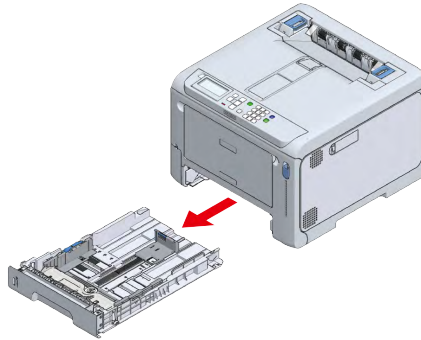

- 2 Slide the paper guide and the blue part of the paper stopper to fit the size of the paper to be loaded.

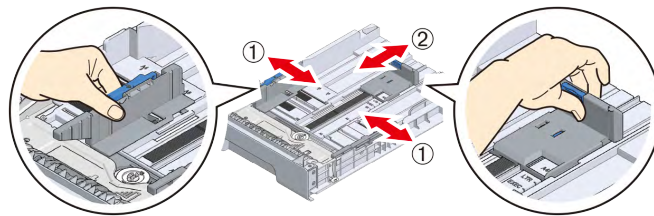

- 3 Shuffle the paper well. Straighten the edges of the paper horizontally.

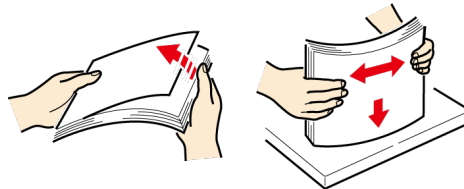

- 4 Load the paper with the printing side down, and press it down from top.



- Do not exceed the ▽ mark on the paper guide when loading paper.

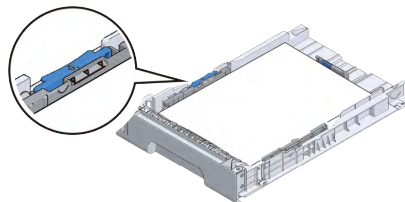

- 5 Return the paper cassette to this machine.

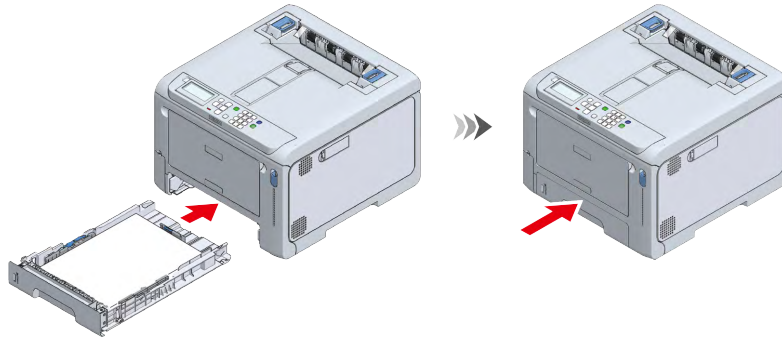

- 6 Set the size, type and weight of the paper on the operator panel.
[Loading paper\(P.72\)](#)

Connecting via a wired LAN

Connect this machine and a PC with a LAN cable to print. Connect the LAN cable, and set the IP address and others on the operator panel.

Connecting the LAN cable

- 1 Prepare a LAN cable (category 5e or better, twisted pair, straight) and a hub.

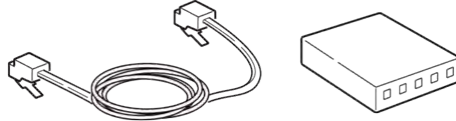

- 2 Power off this machine.
- 3 Plug one end of the LAN cable into the network interface connector (LAN1) of this machine.

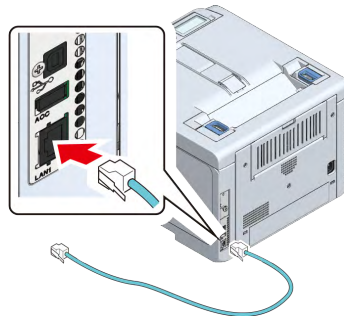

- 4 Plug the other end of LAN cable into the hub.

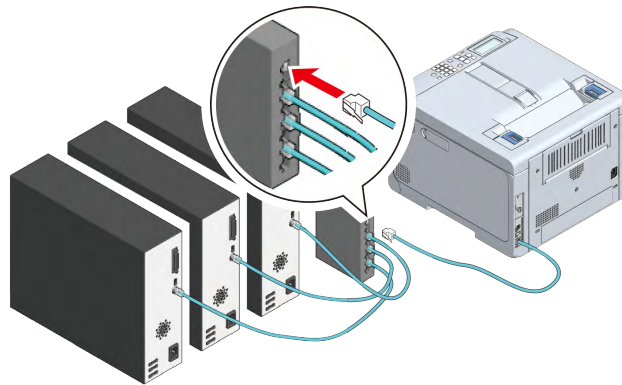

Then, set the network information like the IP address on this machine.

[Setting the IP address, etc.](#)(P.36)

Setting the IP address, etc.

Set values suitable for the current environment on the operator panel.

The following case is taken for example here.

(Example)

- IP address of this machine: 192.168.0.2
- Subnet mask: 255.255.255.0
- Gateway address: 192.168.0.1

When using a wireless LAN, see "[Connecting via a wireless LAN](#)(P.41)".

- 1 Power on this machine.
- 2 Press the scroll button ▼ on the operator panel several times to select [Admin Setup], and press «OK».
- 3 Input the admin password using the numeric keypad, and press «OK».
[Admin password](#)(P.195)
- 4 Check that [Network Setup] is selected, and press «OK».

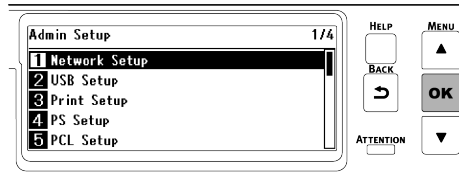

- 5 Press ▼ to select [Wired(LAN1) Setup], and press «OK».

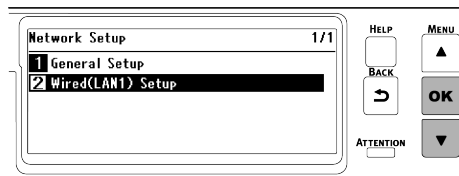

- 6 Press ▼ to select [IP Address Set], and press «OK».

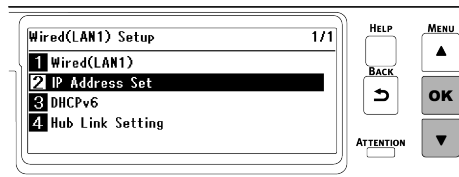

When you set the IP address manually, press ▼ to select [Manual] and press «OK».
Go to Step 7.

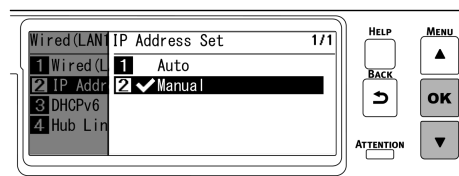

When you set the IP address automatically, check that [Auto] is selected and press «Back».
Go to Step 14.

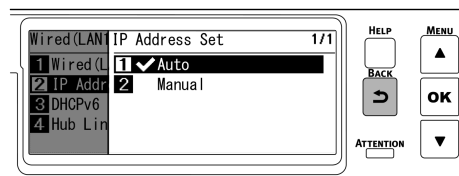

- 7 Press «BACK», then press ▼ to select [IPv4 Address] on the [Wired(LAN1) Setup] screen, and finally press «OK».

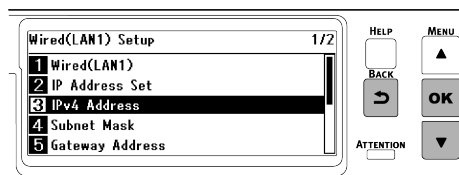

- 8** Use either the scroll buttons or the numeric keypad to input the first 3 digits of the IP address, and press «OK».

Input the next 3 digits in the same way. To move to the next box, press «OK».

Press «OK» after inputting all the digits.

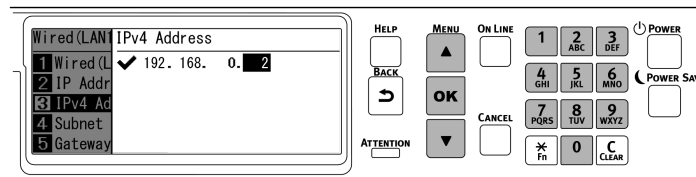

- 9** Check that the cursor has returned to the first 3 digit, and press «BACK».

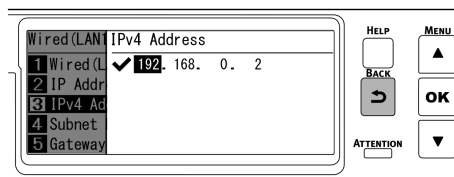

- 10** Press ▼ to select [Subnet Mask], and press «OK».

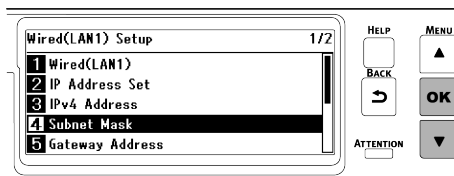

- 11** Input the subnet mask in the same way as the IP address. Press «OK» after inputting all the information, check that the cursor has returned to the first 3 digit, and press «BACK».

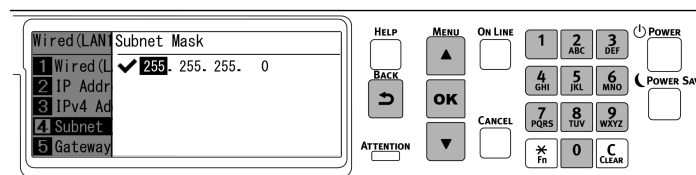

- 12** Press ▼ to select [Gateway Address], and press «OK».

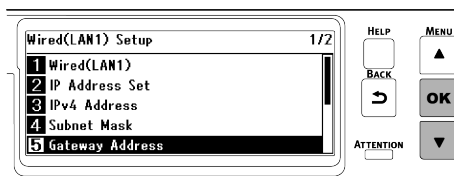

- 13** Input the gateway address in the same way as the IP address. Press «OK» after inputting all the information, check that the cursor has returned to the first 3 digit, and press «BACK».

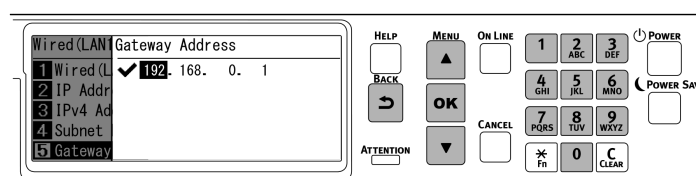

- 14 Press «ON LINE» to return to the standby screen.

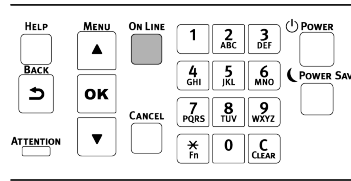

Checking the connection from a PC

Check the IP address of this machine, and access it from a PC by using the Web browser.

- 1 Press the scroll button ▼ on the operator panel several times to select [Configuration], and press «OK».
- 2 Press «5» on the [Configuration] screen.

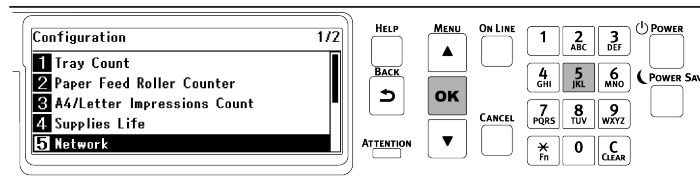

- 3 Check that [Network Setup] is selected, and press «OK».

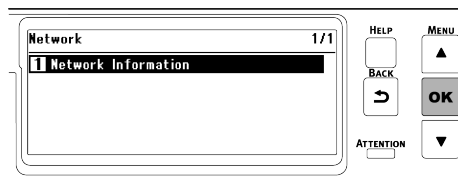

- 4 Press ▼ to select [Wired(LAN1) Information], and press «OK».

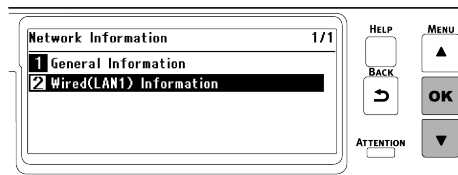

- 5 Press ▼ several times to select [IPv4 Address], and press «OK».

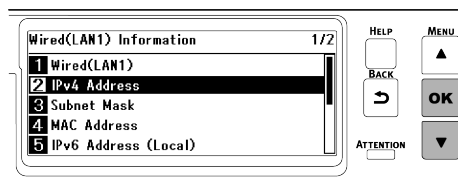

- 6 Take a note of the displayed IP address.
- 7 Start the Web browser in a PC.
- 8 Input "http:// (The IP address recorded in Step 6)", and press the «Enter» key.
Connection is successful when the web page of this machine is displayed.





- If the web page of this machine is not displayed, the network connection between the PC or other terminals and this machine has failed.
Check if [IP Address Set], [IPv4 Address], [Subnet Mask] and [Gateway Address] of this machine are set correctly.

Then, go to "[Installing software on a PC\(P.59\)](#)".

Connecting via a wireless LAN

Connect this machine and a PC via a wireless LAN to print.



- Wired LAN1 and wireless LAN can be used at the same time. If wired LAN1 and wireless LAN are connected to the same subnet, the communication may be unstable.
- Do not place an electric appliance (especially microwave oven or digital cordless telephone) that emits weak electronic waves near this machine.
- Wireless LAN connection may be inferior in communication speed compared to wired LAN connection or USB connection depending on the environment. When printing large data such as photos, we recommend you to print via a wired LAN or USB connection.

If detailed settings such as security and server are required, set them from the web page of this machine.

[Web page \(Managing this machine from a PC\)\(P.201\)](#)

Connection form

There are two types of connection forms between this machine and the PC via a wireless LAN. Select the connection form according to your environment, and prepare what is necessary as per the following table for the connection.

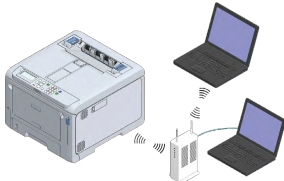
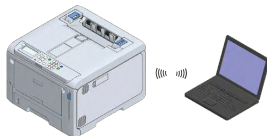

- Wireless LAN (Infrastructure) and wireless LAN (AP mode) cannot be used at the same time.
- Wired LAN1 and wireless LAN can be used at the same time.
- Since the communication may be unstable if wired LAN1 and wireless LAN are connected to the same subnet, please connect to a different subnet.

Type	Infrastructure	AP mode
Connection image		
Description	Connect this machine and the wireless terminal (PC, tablet, smartphone, etc.) via an access point.	Set this machine as a wireless access point, and connect it directly with the wireless terminal (PC, tablet, smartphone, etc.).
Required preparations	<ul style="list-style-type: none"> • Check the following information and take a note. <ul style="list-style-type: none"> Wireless settings of the printer Auto/Manual setting of the IP address For manual setting: <ul style="list-style-type: none"> IPv4 Address Subnet Mask Gateway Address Wireless LAN Access Point SSID Encryption Key • Check that your wireless LAN access point supports the following environment. <ul style="list-style-type: none"> Standard: IEEE 802.11 a/b/g/n Access mode: Infrastructure mode • Check that the wireless LAN access point supports WPS. • If WPS is not supported, check the SSID and encryption key with the User's Manual enclosed with your wireless access point. 	<ul style="list-style-type: none"> • Check that your wireless terminal supports the following environment. <ul style="list-style-type: none"> Standard: IEEE 802.11 b/g/n Security: WPA2-PSK(AES) • Check that your wireless terminal supports WPS-PBC (push button). • If you are not sure whether WPS-PBC is supported, connect manually after turning on the power of this machine.
Connection method	Connecting via an access point (Infrastructure)(P.42)	Connecting directly with this machine (AP mode)(P.53)



- SSID is also called the network name, ESSID or ESS-ID.
- Encryption key is also called the network key, security key, password, or pre-shared key (PSK).

Connecting via an access point (Infrastructure)



- Put this machine in an unobstructed view position near the wireless LAN access point. (The recommended distance is 30 m or less.)
- It may be difficult to connect if there is a metal, aluminum sash or reinforced concrete wall between this machine and the wireless LAN access point.
- When using 2.4GHz for a connection, use it within the range of 1 to 11ch. 12ch and 13ch may be available depending on the country or region.

1. Enabling the wireless LAN function

- 1 Power on this machine.
- 2 Press the scroll button ▼ on the operator panel several times to select [Admin Setup], and press «OK».
- 3 Input the admin password using the numeric keypad, and press «OK».
[Admin password](#)(P.195)
- 4 Check that [Network Setup] is selected, and press «OK».

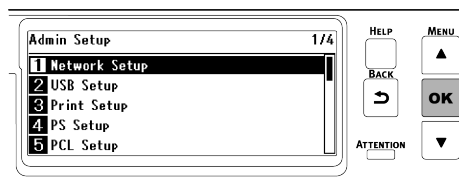

- 5 Check that [General Setup] is selected, and press «OK».

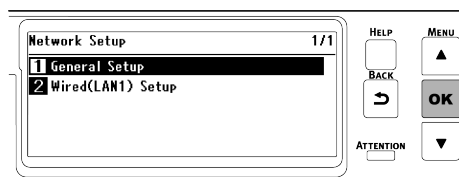

- 6 Check that [Extended Network] is selected, and press «OK».

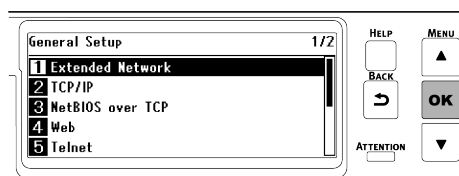

- 7 Press ▼ to select [Wireless], and press «OK».

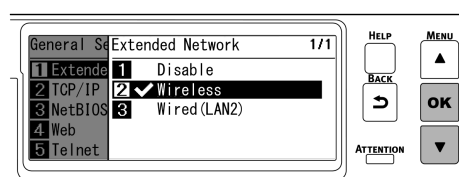

- 8 When [Are You Sure?] is displayed, check that [Yes] is selected, and press «OK».

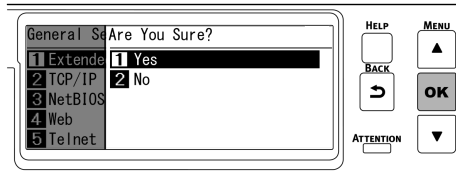

- 9 Wait until the standby screen appears as this machine restarts.
If [Not connected to wireless access point] is displayed, press «OK».
If "Set-up wireless?" is displayed, select [No], and press «OK».

2. Enabling infrastructure

- 1 Press the scroll button ▼ on the operator panel several times to select [Wireless(Infrastructure) Setting], and press «OK».

- 2 Input the admin password using the numeric keypad, and press «OK».

[Admin password](#)(P.195)



- "It is not possible to use the Wireless(AP Mode) at the same time." will be displayed for about 5 seconds.

- 3 Press ▲ to select [Enable], and press «OK».

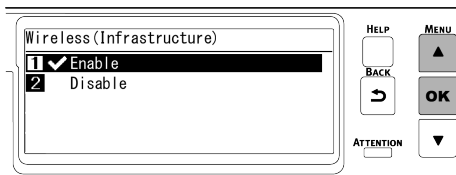

- After setting wireless(AP Mode) to [Disable], if a screen appears to ask you to check whether to enable wireless(Infrastructure), press «OK» to enable wireless (Infrastructure).

To set the IP address of this machine manually, go to "[3. Setting the IP address](#)".

To obtain an IP address automatically, go to "[4. Connecting with the wireless access point](#)".



- The factory default setting is [Auto].

3. Setting the IP address

If you want to set the machine's IP address to a fixed value, follow the procedure below.



- For [Auto], the machine's IP address may change dynamically.



- For [IPv4 Address], set a value which is not overlapped to any other networked machines.
- If you do not use the IPv6 address, set [DHCPv6] to [Disable].

(Example)

- IP address of this machine: 192.168.101.2
- Subnet mask: 255.255.255.0
- Gateway address: 192.168.101.1

When using a wired LAN, see "[Setting the IP address, etc.\(P.36\)](#)".

1 Press the scroll button ▼ on the operator panel several times to select [Wireless(Infrastructure) Setting], and press «OK».

2 Input the admin password using the numeric keypad, and press «OK».

 [Admin password\(P.195\)](#)



- "It is not possible to use the wireless(AP Mode) at the same time." will be displayed for about 5 seconds.

3 Press ▲ to select [Enable], and press «OK».

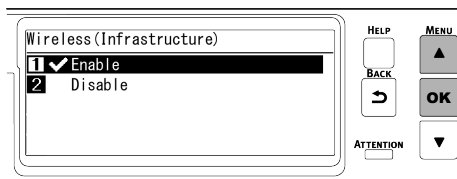

4 Press ▼ to select [Network Setting], and press «OK».

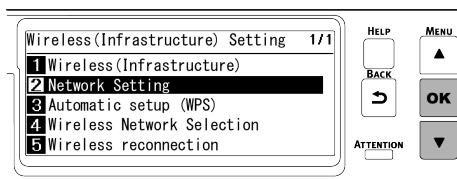

5 Check that [IP Address Set] is selected, and press «OK».

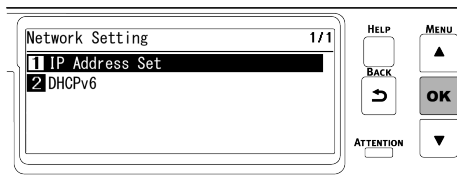

6 Press ▼ to select [Manual], and press «OK».

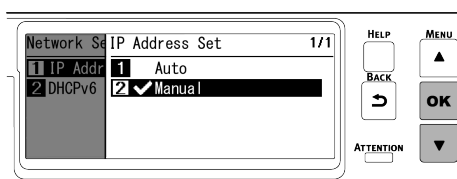

7 Press «BACK», then press ▼ to select [IPv4 Address] on the [Network Setting] screen, and finally press «OK».

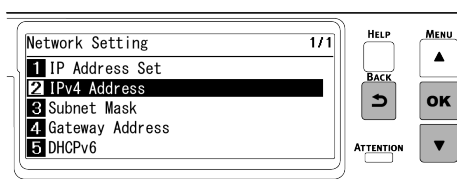

- 8** Use either the scroll buttons or the numeric keypad to input the first 3 digits of the IP address, and press «OK». Likewise, input the next 3 digits, and press «OK». Press «OK» after inputting all the digits.

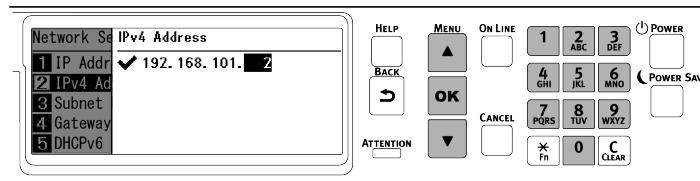

- 9** Press ▼ to select [Subnet Mask], and press «OK».

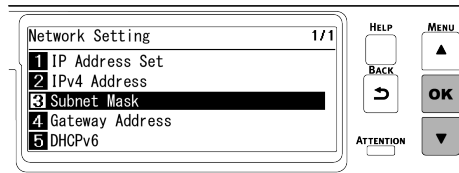

- 10** Input the subnet mask in the same way as the IP address. Press «OK» after inputting all the digits.

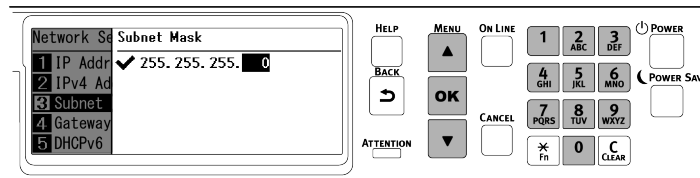

- 11** Press ▼ to select [Gateway Address], and press «OK».

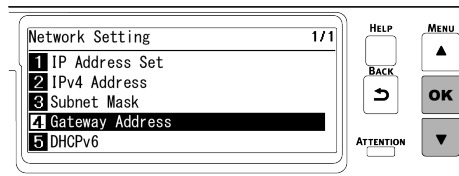

- 12** Input the gateway address in the same way as the IP address. Press «OK» after inputting all the digits.

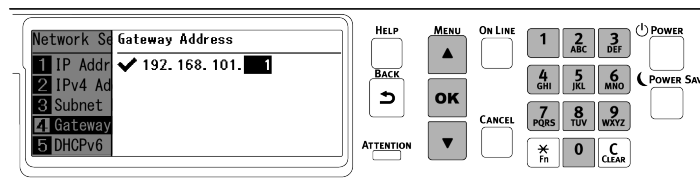

- 13** Press «ON LINE» to return to the standby screen.

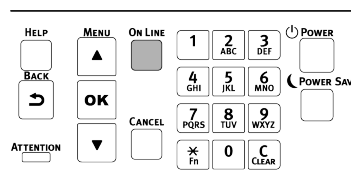

4. Connecting with the wireless access point

There are three ways as follows. Usually, it is connected with the simplest WPS.

- Connecting with WPS
- Connecting by selecting a wireless LAN access point from the operator panel
- Connecting by setting manually from the operator panel



- When you connect with wireless LAN by WPA/WPA2-EAP, see "[Setting IEEE802.1X \(Wireless LAN\)](#)(P.213)".

Connecting with WPS

If the wireless LAN access point supports WPS, you can easily connect to the wireless LAN using the push button for easy setup (WPS button).

- 1 Check the position of push button for easy setup (WPS button) and the time for which the button is pressed in the User's Manual enclosed with the wireless LAN access point.
- 2 Check that the wireless LAN access point is activated and operating properly.
- 3 Press the scroll button ▲ on the operator panel several times to select [Wireless(Infrastructure) Setting], and press «OK».
- 4 Input the admin password using the numeric keypad, and press «OK».

[Admin password](#)(P.195)



- "It is not possible to use the wireless(AP Mode) at the same time." will be displayed for about 5 seconds.

- 5 Press ▲ to select [Enable], and press «OK».

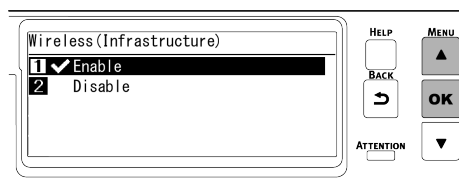

- 6 Press ▼ several times to select [Automatic setup (WPS)], and press «OK».

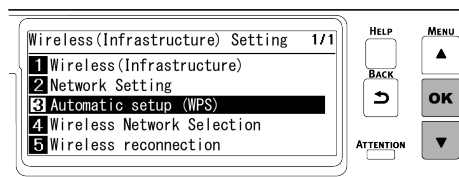

- 7 Check that [WPS-PBC] is selected, and press «OK».

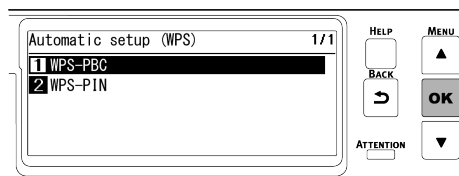

- 8 When "Implementing this method? Pushbutton method" is displayed, check that [Yes] is selected, and press «OK».

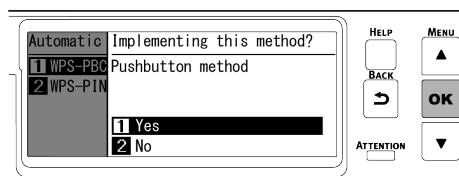

"Running pushbutton method" is displayed, and this machine will start to search for a wireless LAN access point.

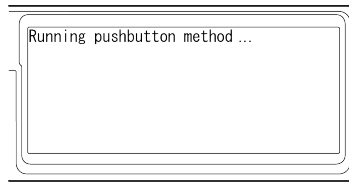

- 9 Press and hold the push button of wireless LAN access point for the period of time confirmed in Step 1 or for a few seconds.



- "Running pushbutton method" is displayed for about 2 minutes. Press the push button of wireless LAN access point while it is displayed.
- While "Running pushbutton method" is displayed, the operator panel of this machine is disabled.

- 10 When "WPS connection successful" is displayed, the connection to the wireless LAN access point is completed.

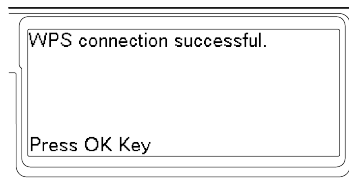

Go to "6. Checking the connection from a PC".



- When "Not connected to wireless access point" or "Connection failed." is displayed, repeat the procedure from Step 1, or try "[Connecting by selecting a wireless LAN access point from the operator panel](#)".

Connecting by selecting a wireless LAN access point from the operator panel

When the wireless LAN access point does not support WPS or when WPS connection does not function well, connect by specifying the wireless access point to be used from the list of wireless access points detected by this machine. In this case, it is required to input the SSID and encryption key.

- 1 Check and take a note of the SSID and encryption key on the side of the wireless LAN access point or in the User's Manual enclosed with the access point.



- WPA-EAP and WPA2-EAP cannot be set from the operator panel. Set them from the web page of this machine.
[Opening the web page](#)(P.201)

- 2 Check that the wireless LAN access point is activated and operating properly.
- 3 Press the scroll button ▼ on the operator panel several times to select [Wireless(Infrastructure) Setting], and press «OK».
- 4 Input the admin password using the numeric keypad, and press «OK».

[Admin password](#)(P.195)



- "It is not possible to use the wireless(AP Mode) at the same time." will be displayed for about 5 seconds.

- 5 Press ▲ to select [Enable], and press «OK».

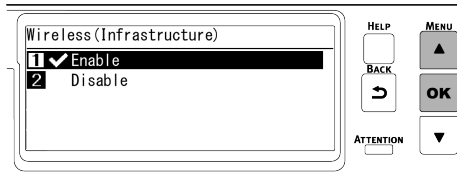

- 6 Press ▼ several times to select [Wireless Network Selection], and press «OK».

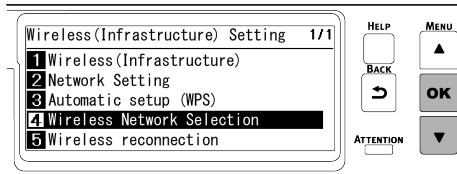

This machine starts searching for wireless LAN access points.

- 7 A list of SSID of connectible wireless LAN access points is displayed. Press ▲ or ▼ to select the SSID of the wireless LAN access point recorded in Step 1, and press «OK».

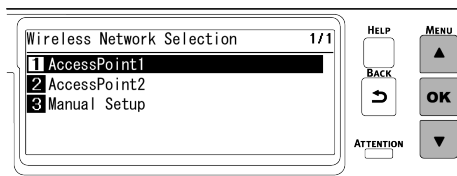

If no wireless LAN access point is found, only [Manual Setup] is displayed. In that case, make settings by following "[Connecting by setting manually from the operator panel](#)".

- 8 When the encryption key entry screen suitable for the encryption method of the selected wireless LAN access point is displayed, input the encryption key recorded in Step 1, and press «OK».



- The encryption key varies with the wireless LAN access point and security method.
 - When "WPA Pre-shared key" is displayed
 - Encryption method: WPA/WPA2-PSK or WPA2-PSK
 - Encryption key: Please input the WPA pre-shared key.
 - When "Please set in Web" is displayed
 - Encryption method: WPA/WPA2-EAP or WPA2-EAP
 - * Make settings from the web page of this machine.
 - When "WEP key" is displayed
 - Encryption method: WEP
 - Encryption key: Please input the WEP key.
 - In other cases
 - Encryption method: Disable
 - No need to input the encryption key.

- 9 "Implementing this method?" is displayed, and the SSID selected in Step 7 from the confirmation screen and the encryption method input in Step 8 are displayed as the security method. If the SSID is the same as the one recorded in Step 1, press «OK».

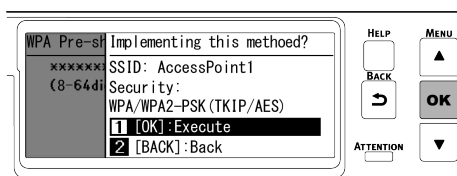

- 10** When "Connection successful." is displayed, the connection to the wireless LAN access point is completed.

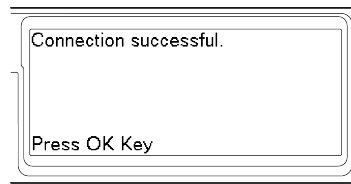

Go to "6. Checking the connection from a PC".



- When "Not connected to wireless access point" is displayed, repeat the procedure from Step 4, or try "Connecting by setting manually from the operator panel".

Connecting by setting manually from the operator panel

Set the wireless LAN access point information (SSID, encryption method, encrypted key) manually, and connect to the wireless LAN.

- Check and take a note of the SSID and encryption key on the wireless LAN access point or in the enclosed User's Manual.
 - WPA-EAP and WPA2-EAP cannot be set from the operator panel. Set them from the web page of this machine.
 - [Opening the web page\(P.201\)](#)
 - SSID is also called the network name, ESSID or ESS-ID.
 - Encryption key is also called the network key, security key, password, or pre-shared key (PSK).
- Check that the wireless LAN access point is activated and operating properly.
- Press the scroll button ▼ on the operator panel several times to select [Wireless(Infrastructure) Setting], and press «OK».
- Input the admin password using the numeric keypad, and press «OK».
 - [Admin password\(P.195\)](#)
 - "It is not possible to use the wireless(AP Mode) at the same time." will be displayed for about 5 seconds.
- Press ▼ several times to select [Wireless Network Selection], and press «OK».

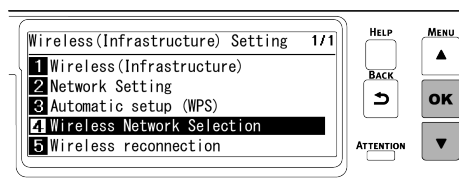

Start searching for wireless LAN access points. Please wait.

- A list of SSID of connectible wireless LAN access points is displayed. Press ▼ several times to select [Manual Setup] at the end of the list, and press «OK».

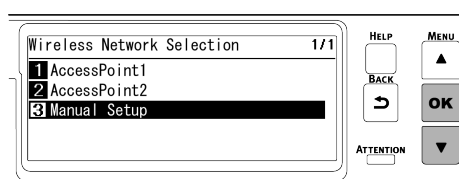

- 7 Check that [SSID] is selected, and press «OK».

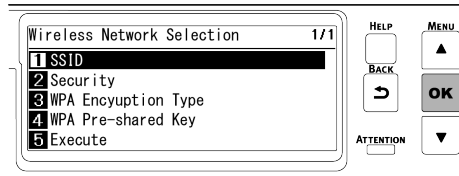

- 8 Input the SSID recorded in Step 1, and press «OK».

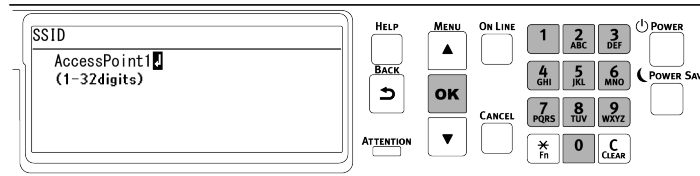

- 9 Press ▼ to select [Security], and press «OK».

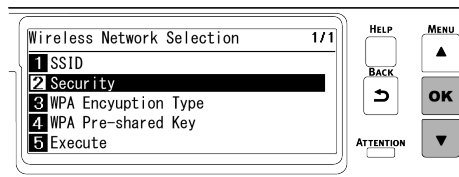

- 10 Select the encryption method recorded in Step 1, and press «OK».

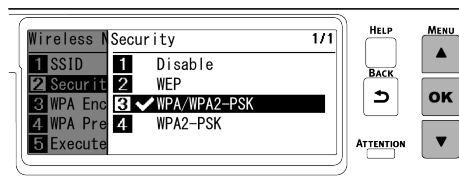

- 11 Press ▼ to select [WPA Pre-shared Key], and press «OK».

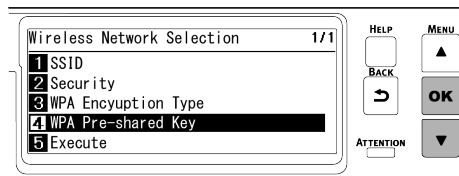

- 12 Input the encryption key recorded in Step 1, and press «OK».

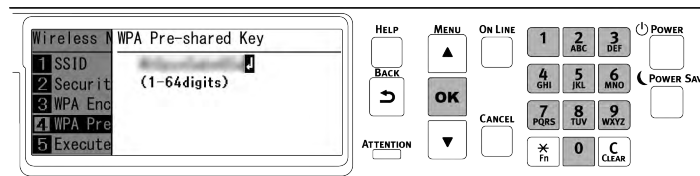

- The encryption key varies with the wireless LAN access point and security method.

- 13 Press ▼ to select [Execute], and press «OK».

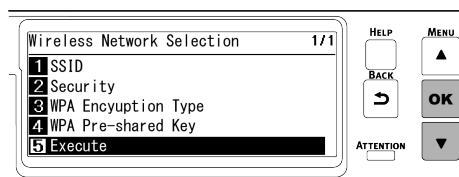

- 14** "Implementing this method?" is displayed, and the SSID selected in Step 8 from the confirmation screen and the encryption method input in Step 10 are displayed as the security method. If the SSID is the same as the one recorded in Step 1, press «OK».

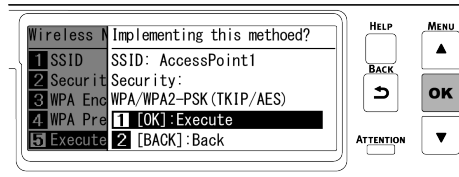

- 15** When "Connection successful." is displayed, the connection to the wireless LAN access point is completed.

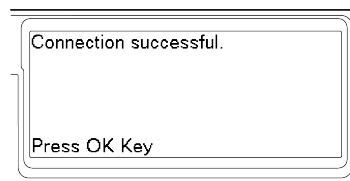

Go to "6. Checking the connection from a PC".



- When "Not connected to wireless access point" is displayed, repeat the procedure from Step 4.
- If you cannot connect, see "[Troubleshooting for wireless LAN connection](#)(P.356)".

5. Choosing a valid default gateway

By default, [Enabling Default Gateway] is set to [Wired(LAN1)]. This machine can use a wired LAN and wireless LAN at the same time, but only either of them can be used to connect a terminal outside the segment (a different subnet).

When a wireless LAN (infrastructure) is used to communicate across segments, follow the following procedure to change into [Wireless(Infrastructure)].

- 1** Check that "Ready To Print" appears on the display.



- If the machine is in the power save mode, press «POWER SAVE» to restore.

- 2** Press the scroll button ▼ on the operator panel several times to select [Admin Setup], and press «OK».

- 3** Input the admin password using the numeric keypad, and press «OK».

[Admin password](#)(P.195)

- 4** Check that [Network Setup] is selected, and press «OK».

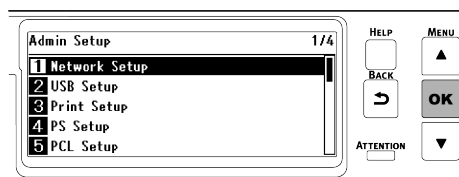

- 5 Check that [General Setup] is selected, and press «OK».

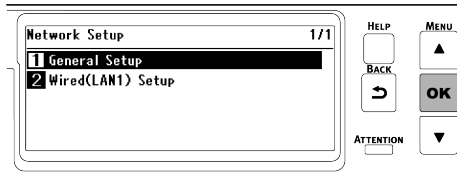

- 6 Press ▼ to select [Enabling Default Gateway], and press «OK».

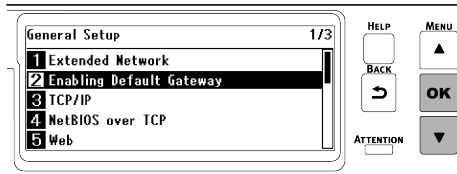

- 7 Press ▼ to select [Wireless(Infrastructure)], and press «OK».

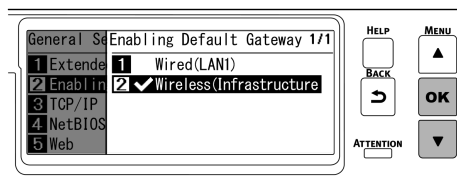

- 8 Press «ON LINE» to return to the standby screen.

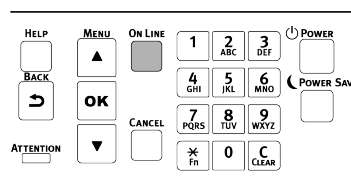

6. Checking the connection from a PC

Check the IP address of the device, and access it from a PC by using the Web browser.

- 1 Press the scroll button ▼ on the operator panel several times to select [Configuration], and press «OK».
- 2 Press «5» on the [Configuration] screen.

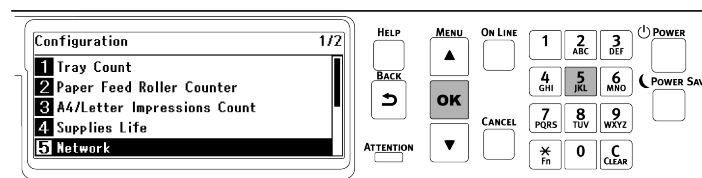

- 3 Press ▼ to select [Wireless(Infrastructure) Information], and press «OK».

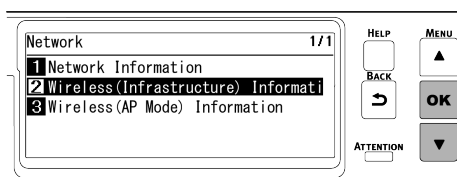

- 4 Press ▼ several times to select [IPv4 Address], and press «OK».

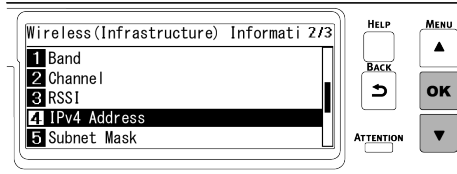

- 5 Take a note of the displayed IP address.
- 6 Start the web browser in a PC.
- 7 Input "http://" (The IP address recorded in Step 5)", and press the «Enter» key.
Connection is successful when the web page of this machine is displayed.



- If the web page of this machine is not displayed, the network connection between the PC or other terminals and this machine has failed.
Check that [IP Address Set], [IPv4 Address], [Subnet Mask], [Gateway Address] and [Enabling Default Gateway] have been set correctly for this machine.

Then, go to "[Installing software on a PC\(P.59\)](#)".

When using a mobile device, go to "[Printing from a mobile device\(P.286\)](#)".

Connecting directly with this machine (AP mode)



- It may be difficult to connect if there is a metal, aluminum sash or reinforced concrete wall between this machine and the wireless terminal.
- Up to 4 terminals can be connected to this machine wirelessly (AP mode). You cannot connect 5 or more terminals.

1. Enabling the wireless LAN function

- 1 Power on this machine.
- 2 Press the scroll button ▼ on the operator panel several times to select [Admin Setup], and press «OK».
- 3 Input the admin password using the numeric keypad, and press «OK».
[Admin password\(P.195\)](#)
- 4 Check that [Network Setup] is selected, and press «OK».

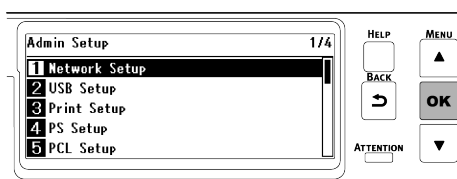

- 5 Check that [General Setup] is selected, and press «OK».

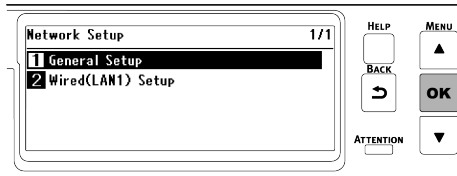

- 6 Check that [Extended Network] is selected, and press «OK».

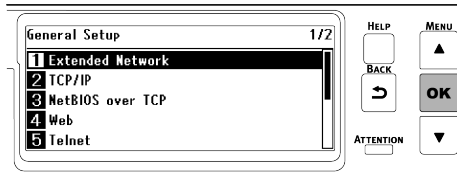

- 7 Press ▼ to select [Wireless], and press «OK».

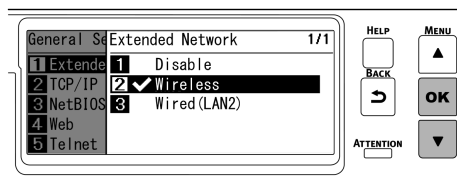

- 8 When [Are You Sure?] is displayed, check that [Yes] is selected, and press «OK».

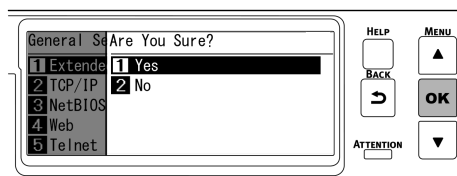

- 9 Wait until the standby screen appears as this machine restarts.

2. Enabling the AP mode

- 1 Press the scroll button ▼ on the operator panel several times to select [Wireless(AP Mode) Setting], and press «OK».
- 2 Input the admin password using the numeric keypad, and press «OK».
[Admin password](#)(P.195)
- 3 Check that [Wireless(AP Mode)] is selected, and press «OK».

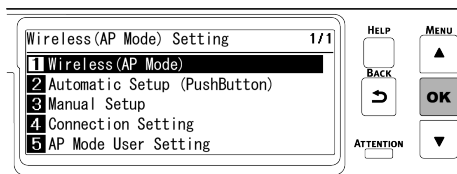

- "Cannot be used simultaneously with wireless(infrastructure)." will be displayed for about 5 seconds.

- 4 Press ▲ to select [Enable], and press «OK».

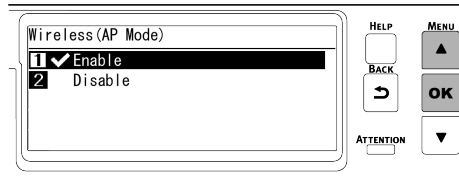

- After setting Wireless(Infrastructure) to [Disable], if a screen appears to ask you to check whether to enable wireless (AP mode), press «OK» to enable wireless (AP mode).

- 5 Press «ON LINE» to return to the standby screen.

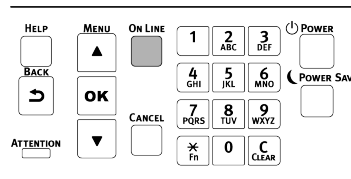

3. Connecting with a device

There are two ways as follows.

- Connecting automatically(Push button)
- Connecting manually

Connecting automatically (Push button)

If the wireless terminal supports WPS-PBC (push button), you can connect it to this machine using the WPS button.

- 1 Check the position of the WPS button in the User's Manual enclosed with the wireless terminal.
- 2 Press the scroll button ▼ on the operator panel several times to select [Wireless(AP Mode) Setting], and press «OK».
- 3 Input the admin password using the numeric keypad, and press «OK».

 [Admin password\(P.195\)](#)



- "Cannot be used simultaneously with wireless(infrastructure)." will be displayed for about 5 seconds.

- 4 Press ▲ to select [Enable], and press «OK».

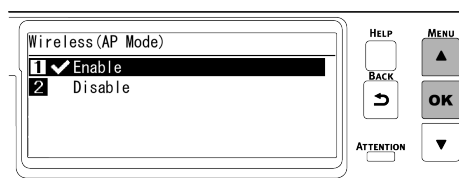

- 5 Press ▼ to select [Automatic Setup (PushButton)] , and press «OK».

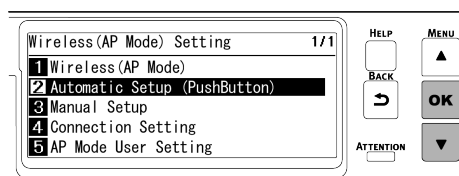

- 6 When "Implementing this method? Pushbutton method" is displayed, check that [Yes] is selected, and press «OK».

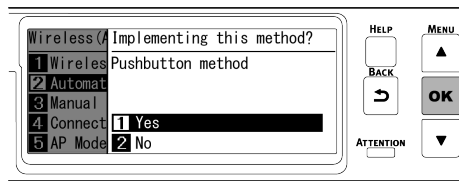

"Running pushbutton method" is displayed, and this machine will start to search for a wireless LAN access point.

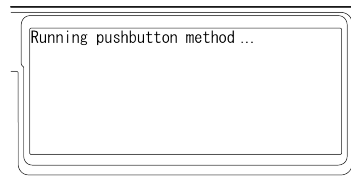

- 7 Start WPS-PBC (push button) on the wireless terminal.



- "Running pushbutton method" is displayed for about 2 minutes. Start the push button on the wireless terminal while it is displayed.
- While "Running pushbutton method" is displayed, the operator panel of this machine is disabled.

- 8 When "Connection successful." is displayed, the connection is completed.

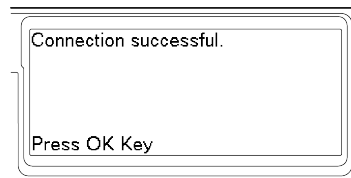

- If the connection fails, follow the procedure in "[Connecting manually](#)" to connect again.

Then, go to "[Installing software on a PC\(P.59\)](#)".

When using a mobile device, go to "[Printing from a mobile device\(P.286\)](#)".

Connecting manually

If the wireless terminal does not support WPS-PBC (push button), input the SSID and password of this machine in the wireless terminal to connect.

- 1 Press the scroll button ▼ on the operator panel several times to select [Wireless(AP Mode) Setting], and press «OK».

- 2 Input the admin password using the numeric keypad, and press «OK».

[Admin password\(P.195\)](#)



- "Cannot be used simultaneously with wireless(infrastructure)." will be displayed for about 5 seconds.

- 3 Press ▲ to select [Enable], and press «OK».

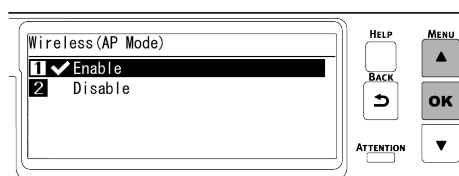

- 4 Press ▼ several times to select [Manual Setup], and press «OK».

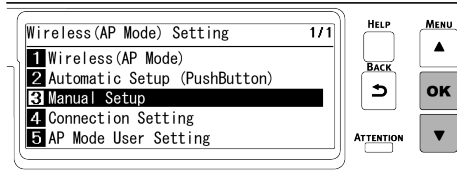

- 5 Check that [SSID] and [Password] of this machine are displayed.



- The screens shown here are examples, and they may differ from the actual display.

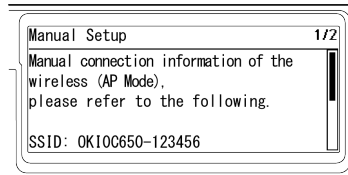

- 6 Input [SSID] and [Password] of this machine confirmed in Step 5 in the wireless terminal to connect.



- If the wireless terminal is set to obtain the IP address automatically, you can communicate by connecting to this machine in the AP mode and allocating the IPv4 address automatically to the mobile terminal.
- The factory default IP address is [192.168.110.100].
- If you cannot connect, see "[Troubleshooting for wireless LAN connection](#)(P.356)".

Then, go to "[Installing software on a PC](#)(P.59)".

When using a mobile device, go to "[Printing from a mobile device](#)(P.286)".

Connecting via USB

Connect this machine and a PC with a USB cable to print.

1 Prepare a USB 2.0 cable.



- Not compatible with USB 3.0.
- The connector shape on the machine side is of type B.



- To connect in the USB 2.0 hi-speed mode, use a USB cable compliant with USB 2.0 hi-speed specifications.

2 Power off this machine.

3 Plug one end of the USB cable into the USB interface connector of this machine.



- Do not insert the USB cable into the network interface connector. Doing so may cause a malfunction.

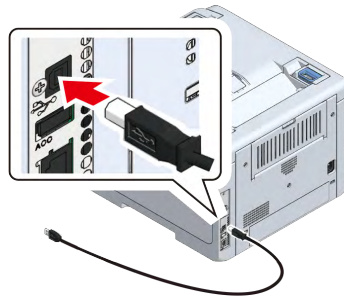

4 Plug the other end of the USB cable into the USB interface connector of the PC.

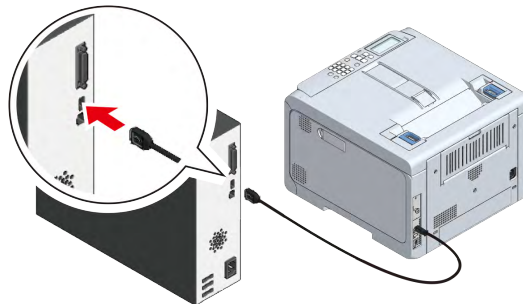

Proceed to "[Installing software on a PC\(P.59\)](#)".

Installing software on a PC

If your PC comes with a DVD drive, install the printer driver and other software on the PC from the provided DVD.

If your PC does not come with a DVD drive, or if you want to update the printer driver or any other software, download and install it from the website.

Operating environment

- Windows 10
- Windows 8.1
- Windows 8
- Windows 7
- Windows Server 2019
- Windows Server 2016
- Windows Server 2012 R2
- Windows Server 2012
- Windows Server 2008 R2
- Windows Server 2008
- macOS 10.15 - 10.12, OS X 10.11



- The screen display may differ from the description depending on the version of Windows and macOS or the specific printer driver.

Types of printer driver

There are two types of printer driver, the PCL printer driver and the PS printer driver. For normal printing, use the PCL printer driver. The PS printer driver is suitable for printing documents containing the ESP data or the PostScript font.

[Screens and functions of the printer driver\(P.133\)](#)



- Only the PS printer driver is applicable to macOS.

For Windows

- 1 Check that this machine and the PC are connected, and that the power supply is on.
- 2 Insert the provided DVD to the PC.



- To install the driver from the provided DVD, it is necessary to install and enable .NET Framework 3.5 or above.

3 When the [DVD drive] screen is displayed, click [Launch Setup.exe].

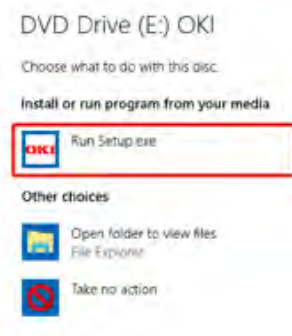

- If the [User Account Control] screen is displayed, click [Yes].
- If the [DVD drive] screen is not displayed, open DVD from the Explorer.

4 Choose a language from the pull-down menu of language selection in the [Welcome] screen.

5 Read the software license agreement, and click [Accept].

6 Read the environmental advice, and click [Go].

7 Click either [Network Connection] or [USB Connection] depending on the connection method between the PC and this machine.

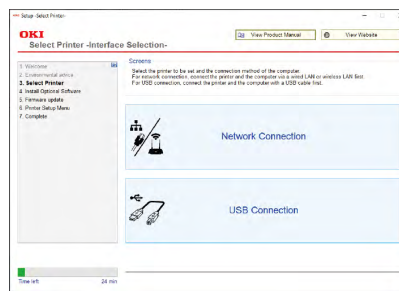

If [Windows Security Alert] screen is displayed, click [Allow Access].

8 Select the model name of this machine, and click [Go].



- If the printer is not displayed with a network connection, input the IP address assigned to the printer by selecting [Search Range], and click [Search Again].

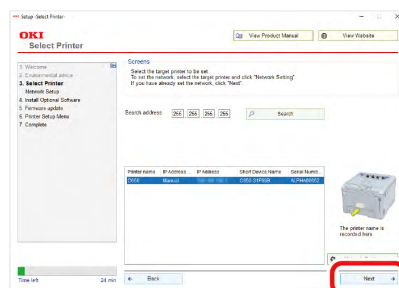

9 Click [Recommended Install].

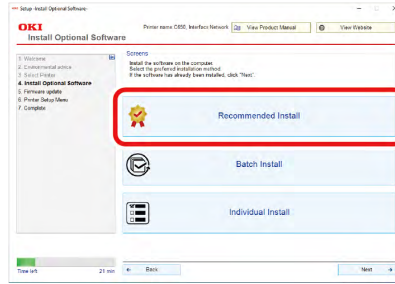

Check the software, and click [Start].

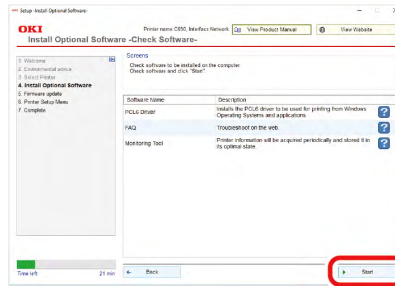

Installation will begin.



- The following software will be installed.
 - PCL6 printer driver (including Network Extension, Color Swatch Utility)
 - FAQs
 - Monitoring Tool
- Other software is installed from either [Batch Install] or [Individual Install].

10 Check that the software installation is complete.

11 Click [Exit].

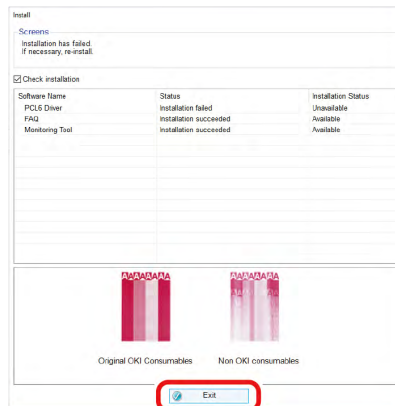

The [Firmware Update] screen is displayed.

- 12** If you do not need to update, click [Go].
Click [Confirm] if you do not know or an update is required.

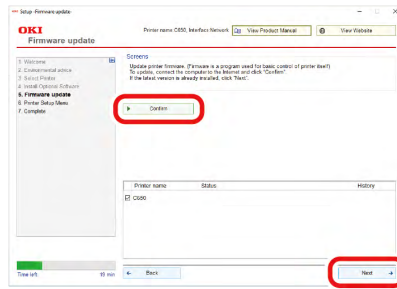

If the following screen appears, click [Yes].

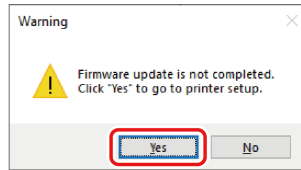

After the update is completed, click [Go].

- 13** Click [Go].

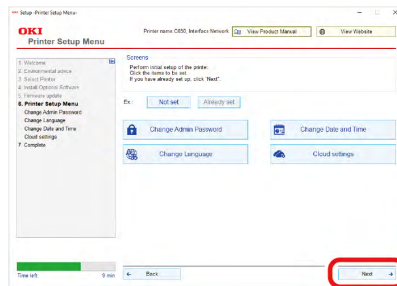

If the following screen appears, click [Yes].

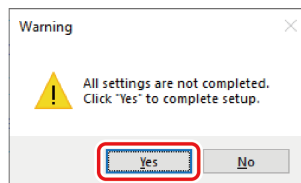

- 14** Click [Exit].

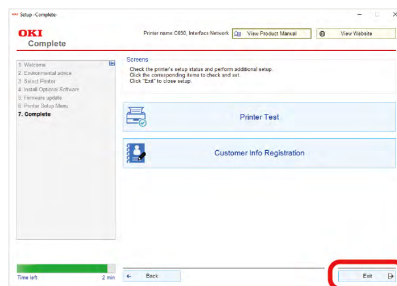

Now installation is completed.

If you install options like the expansion tray unit, change the settings of printer driver.

[Setting the printer driver\(P.64\)](#)

When the Monitoring Tool is displayed, register the installed printer.

[Monitoring Tool \(Windows\)\(P.249\)](#)

For macOS

- 1 Check that this machine and the PC are connected, and that the power supply is on.
- 2 Insert the included DVD to the PC.
- 3 Double-click on the [OKI] icon on the desktop.
- 4 Double-click on [Drivers] - [PS] - [Installer for OSX].
- 5 Finish the installation by following the on-screen instructions.
- 6 Select [System Preferences] from the Apple menu.
- 7 Click [Printers and Scanners].
- 8 Click [+], and select [Add Printer or Scanner] when the menu appears.

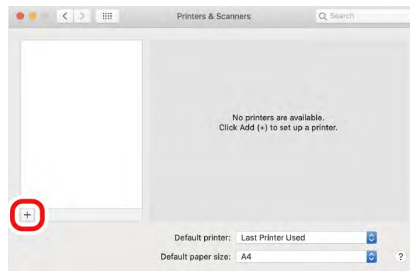

- If you cannot click [+], click the key mark.

- 9 Click [Default].
- 10 Select this machine, and select [OKI C650 PS] from [Drivers].

Connection Method	Listed name	Type
Network	OKI-C650 (Last 6 digits of the MAC address)	Bonjour
USB	OKI DATA CORP C650	USB



- The MAC address can be checked by pressing the scroll buttons on the operator panel to print the network information from [Print Information] - [Network].
- To change the name, input a new name to be used in [Name].

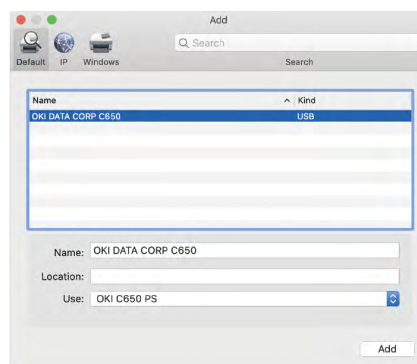

- 11 Click [Add].



- If the option confirmation screen appears, click [OK].

- 12 Make sure that this machine is added to the list of [Printers] and that "OKI C650 PS" is displayed in [Type].

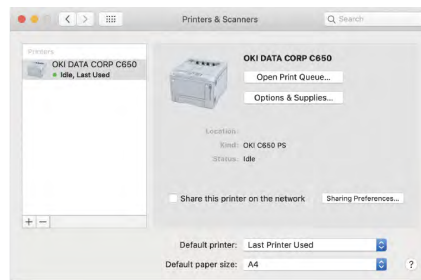

- If "OKI C650 PS" is not displayed in [Type] properly, click [-] to delete this machine from [Print], and then repeat Steps 8 - 12.

- 13 Click [Open the Print Queue].

- 14 Select [Print Test Page] from the [Print] menu.

Installation is completed when the test page is printed.

If you install options like the expansion tray unit, change the settings of printer driver.

[Setting the printer driver\(P.64\)](#)

Setting the printer driver

If an expansion tray unit has been installed, change the printer driver settings with the following procedure after installing the printer driver.

[Installing software on a PC\(P.59\)](#)



- To follow this procedure, it is necessary to log into the computer with administrator privileges.

For Windows PCL printer driver

- 1 Open the "Devices and Printers".

[How to open the printer folder\(P.142\)](#)

- 2 Right-click on the icon of [OKI C650 PCL], and select [Printer Properties].

- 3 Select the [Device Options] tab.

4 For a network connection, click [Get Printer Settings].

For a USB connection, input the number of trays minus the MP tray in [Installed Paper Trays].

For example, if three expansion tray units are mounted, the usable trays are trays 1/2/3/4, so input "4".

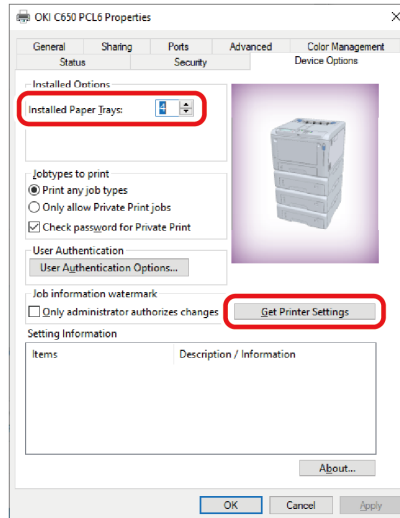

5 Click [OK].

For Windows PS printer driver

1 Open the "Devices and Printers".

[How to open the printer folder](#)(P.142)

2 Right-click on the icon of [OKI C650 PS], and select [Printer Properties].

3 Select the [Device Settings] tab.

4 For a network connection, select [Get installed options automatically] in [Installable Options], and click [Setup].

For a USB connection, select the corresponding value in [Available Trays] of [Installable Options].

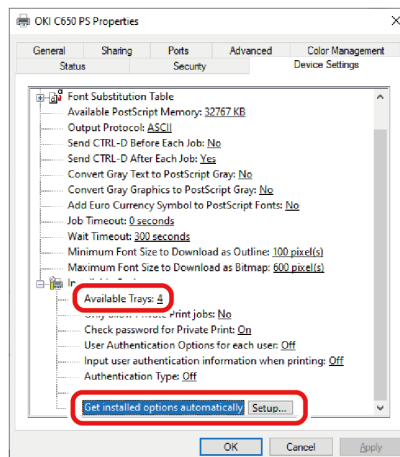

5 Click [OK].

For macOS



- Depending on the timing when the printer is added, the information for the expansion tray unit may have been set.

- 1 Select [System Preferences] from the Apple menu.
- 2 Click [Print & Scan].
- 3 Select this machine, and click [Options and Supplies].
- 4 Select the [Options] tab.
- 5 Select the total number of trays from [Available Trays], and click [OK].

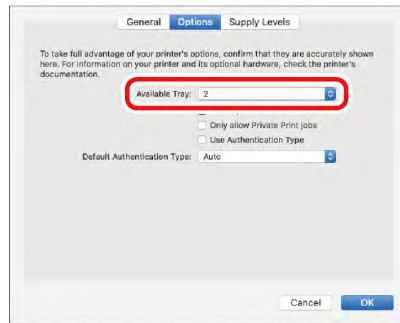

3 Basic operations

Parts identification	68
Turning the power on/off	71
Loading paper	72
Setting the output bin	84
Checking the configuration.....	86
How to use levers L1 and L2.....	88

Parts identification

This section explains the name and functions of each part of the main unit.

Front

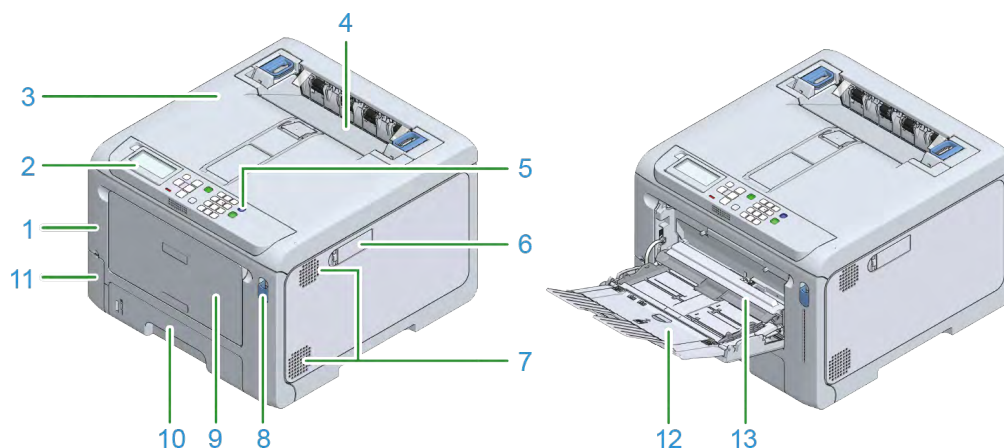

No.	Name	Function
1	Front cover	This is the cover on the front side of the main unit. You can open the front cover by pulling its lever towards yourself.
2	Operator panel	This is the panel used to operate the main unit. It comes with a display, functional buttons, a numeric keypad, a Fn key, an attention lamp, etc. Parts identification of the operator panel(P.91)
3	Output tray (Top cover)	This is the output tray on the top of the main unit. You can open it by pulling up the open lever inside after opening the front cover.
4	Fuser unit	This unit fixes the toner to the paper.
5	Power switch	Turns on/off the power of the main unit. Lights blue when the power is turned on, and lights off when the power is turned off.
6	Wireless LAN module cover	A cover for the housing of the wireless LAN module.
7	Air vents	Allows air to enter and exit from the inside of the main unit. Be careful not to block the air vents.
8	Front cover lever	This is a blue lever to unlock to open the front cover.
9	Multi Purpose Tray (MP tray)	In addition to paper of various sizes, you can also print on envelopes.
10	Tray 1	Load the paper to print on.
11	Waste toner box cover	This is the storage port of the box that holds the waste toner.
12	Paper supporter	Load the paper in the MP tray.
13	Paper placement cover	Holds the paper loaded in the MP tray.

Inside the main unit

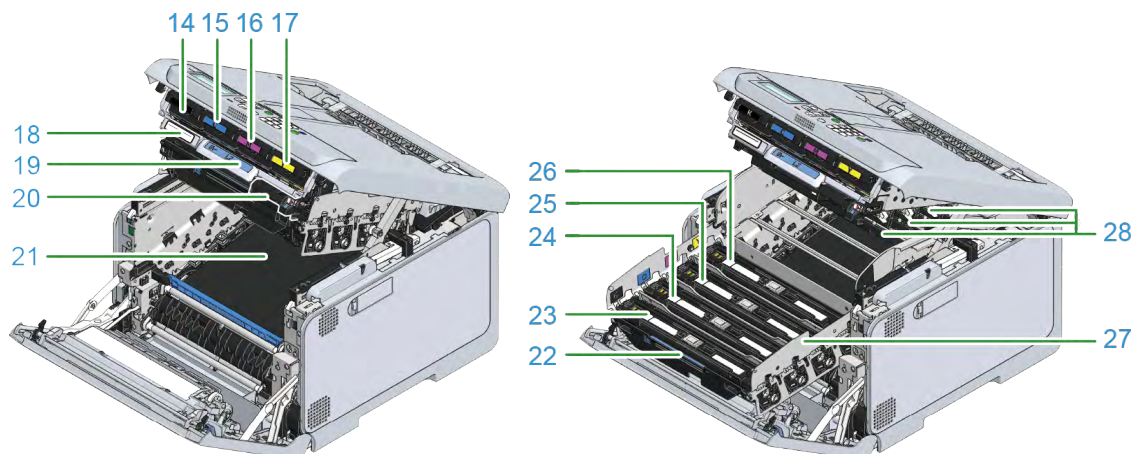

No.	Name	Function
14	Toner cartridge black (K: Black)	The toner cartridge contains toner (powder ink) for printing. The toner cartridge is a consumable.
15	Toner cartridge (C: Cyan)	
16	Toner cartridge (M: Magenta)	
17	Toner cartridge (Y: Yellow)	
18	Serial number	The machine-specific number.
19	Lever L2	The lever used to lift up the cover of the output tray.
20	Lever L1	The lever uses to replace the image drum.
21	Belt unit	The unit to convey the paper.
22	Handle L3	The handle used to pull out the image drum basket.
23	Image drum (K: Black)	The image drum is a unit to create an image on the paper by using toner. The image drum is a consumable.
24	Image drum (C: Cyan)	
25	Image drum (M: Magenta)	
26	Image drum (Y: Yellow)	
27	Image drum basket	Holds the image drum.
28	LED head (x 4)	Writes an image onto the image drum using light.

Back

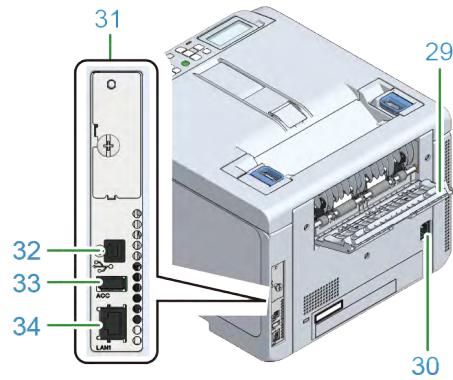

No.	Name	Function
29	Rear output tray	This is the paper exit when the paper is output with the print side facing up.
30	Power connector	This is where the included power cord is plugged in.
31	Interface unit	There is a connector to connect to a PC.
32	USB interface connector	This is where the USB cable is plugged in when the computer and the main unit is connected with a USB cable.
33	Accessory connector	This is a port to which the USB memory is connected.
34	Network interface connector (LAN1)	This is where the LAN cable is plugged in when the computer and the main unit is connected via a network.

Turning the power on/off

Turning the power on

- 1 Press and hold the power switch for approx. one second.

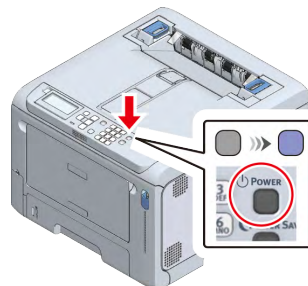

When the power is on, the LED lamp of the power switch will light on.
When this machine gets ready, "Ready To Print" will appear on the display.

Turning the power off

- 1 Press and hold the power switch for approx. 1 second.

"Shutting down. Please wait. The power will turn off automatically" will appear on the display, and the LED lamp of the power switch will flash at intervals of approx. 1 second.

Wait a moment, and this machine will be powered off automatically, and the LED lamp of the power switch will turn off.



- If you press and hold the power switch for approx. 1 second while this machine is in the power save mode, the power will turn off without displaying anything.
- Please wait. This may take about 5 minutes to turn off the power.
- Press and hold the power switch for more than 5 seconds to turn off the power by force. Use only if a problem has occurred. For troubles with this machine, refer to "[Troubleshooting for the machine](#)(P.374)".

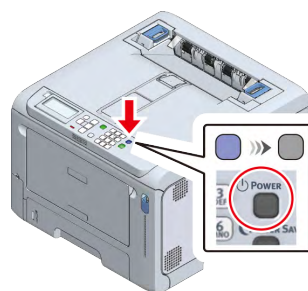

Loading paper

This section explains the types of paper applicable to this machine, paper precautions and paper storage methods.

Procedure for loading paper

1. Check the applicable paper.

- [Applicable paper\(P.72\)](#)
- [Inapplicable paper\(P.74\)](#)

2. Load the paper in the tray.

- [Paper applicable to each tray\(P.76\)](#)
- [Loading paper in Tray 1\(P.76\)](#)
- [Loading paper in Tray 2/3/4 \(Optional\)\(P.78\)](#)
- [Loading paper in the MP tray\(P.80\)](#)

3. Set the paper information (media size, media type, media weight) on the operator panel.

- [Setting paper information on the operator panel\(P.81\)](#)

Applicable paper

In order to maintain high-quality printing, it is necessary to use paper that fulfills the quality, weight and surface finish conditions. Please use electrophotographic paper.

If you are printing on non-recommended paper, thoroughly test the print quality and paper traction beforehand and check that there are no problems before use.

For precautions for printing on various types of paper, refer to "[Paper precautions by type\(P.74\)](#)".

Media Type	Paper size	Paper weight	Other conditions
Plain	A4	For simplex printing: 60 - 256 g/m ²	The custom-sized paper must meet the requirements for plain paper. B6 half, B7, B8 and 4 x 6 inches paper are not applicable to duplex printing.
	A5		
	A6	For duplex printing: 64 - 176 g/m ²	
	B5		
	B6		
	B6 Half		
	B7		
	B8		
	Letter		
	Legal (13 inches)		
	Legal (13.5 inches)		
	Legal (14 inches)		
	Executive		
	Statement		
	8.5-inch SQ		
	Folio (210 x 330 mm)		
	16K (184 x 260 mm)		
	16K (195 x 270 mm)		
16K (197 x 273 mm)			
4 x 6 inches			
5 x 7 inches			

Media Type	Paper size	Paper weight	Other conditions
	Long paper Custom Width: 55 - 216 Length: 91 - 1321		
Envelope	Com-9 Com-10 Monarch DL C5	Media using 24 lb paper	Media made of craft paper, electrophotographic paper or dry PPC paper. Media with the flap folded tightly. Duplex printing is not available.
Index Card	3 x 5 inches		Duplex printing is not available.
Label	A4 Letter	Total weight: 0.1 - 0.2 mm	Labels for electrophotographic printers or dry PPCs where the surface paper, adhesive, and backing are not degraded by heat. Media with a structure that prevents the front paper from peeling off from the backing in the heat fixing process of the printer. Media with a structure that prevents the front paper from peeling off the backing when the paper is traveling. Media with a combined weight of 0.1 to 0.2 mm of front paper and backing. Media whose surface paper covers the entire backing sheet with no adhesive sticking out. Media with no breaks or creases. Duplex printing is not available.
Partially printed paper	Equivalent to plain paper	64 - 256 g/m ²	Media that meets the requirements for plain paper. Media whose ink used for partial printing is heat resistant and can withstand 230°C.
Colored paper	Equivalent to plain paper	64 - 256 g/m ²	Media whose pigment or ink used to color the paper is heat resistant and can withstand 230°C. Media made of electrophotographic paper with the same features as plain paper.
Long paper	Width: 210 mm Length: 356 to 1320 mm	128 g/m ²	If the length of the paper exceeds 356 mm, the width must range from 210 mm to 216 mm.



- If the paper grain direction does not match the paper feeding direction, paper jams may occur.
- Printing from the MP tray may cause wrinkles. In this case, feed paper from the paper cassette.
- The paper wrapper shows the orientation of the surface. Load paper properly so that the face side is the printing side.
- The paper is wrapped in moisture-proof paper to prevent moisture. Please use the paper as early as possible after opening its package.
- Wrap unused paper in the wrapping paper, and keep it away from moisture absorption as much as possible.
- If it is used beyond the normal room temperature (temperature: 17°C to 25°C; humidity: 40% to 60%), the printing quality may be degraded or problems may occur such as paper jams, wrinkles, curls, and warpage.
- Depending on the installation environment of the machine, printing on paper that contains moisture may cause white steam or water droplets to appear around the paper exit area of the machine. This is not abnormal because the heat generated when the toner is fixed to the paper evaporates the moisture contained in the paper.

Inapplicable paper

Do not use the following types of paper. Doing so may cause paper jams or malfunction.

- Paper with smooth surface, rough paper, and paper with different front and back roughness
- Paper that is too thin or too thick
- Paper with much paper dust
- Short grain paper (Do not use for vertical feeding.)
- Wet (damp) paper
- Paper with curl, curve or wave due to humidity
- Paper stuck by static electricity
- Paper and envelopes that have been textured, embossed or coated
- Paper specially processed with glue, chemicals, etc.
- Paper specially processed without heat resistance (230°C)
- Paper with holes, perforations, notches, holes for binder
- Paper that has irregularities, crushing, burrs, etc. on the paper cut surface
- Non-square shaped paper, or paper whose cutting angle is not right
- Paper or envelopes with wrinkles, warping, corner bending, waving, creases, tears, etc.
- Paper with staples, clips, ribbons, tapes, clasps, etc.
- Special paper such as carbon paper, non-carbon paper, thermal paper, and pressure-sensitive paper
- Thermal transfer printer paper, ink jet paper, wet PPC paper, copying paper, Japanese paper, etc.
- Envelopes stucked with stamps
- Envelopes that are too thick
- Envelope made of plastic
- Double envelopes with inner bags
- Envelopes with clasps, buttons or windows
- Envelopes stucked with double-sided tape or with adhesive on the flap
- Envelopes with water repellency

Paper precautions by type

Plain

- The printing speed will be slowed when the paper size is set to [A6] or [A5] (lengthwise direction) or when the paper width is set to 182 mm or less.
- For thick paper, the toner may stick thinly to the whole paper or the printing may be light.

Partially printed paper

- When a printing frame is set, design it with careful considerations of the following variations in the printing position.
Output position accuracy: ± 2 mm; paper slant: ± 1 mm/100 mm; image expansion and contraction: ± 1 mm/100 mm (When GSM paper weight is 80 g/m²)
- This machine cannot print over a printed area.

Envelope

- The paper may warp or wrinkle after printing.
- The toner may stick thinly to the whole paper or the printing may be light.

- The toner may be easily removed.
- The printing quality may decline in an area of about 5 mm around the sealing part (of different weights) of the envelope.
- The warps on an envelope may cause poor paper feeding. Use the envelope after correcting warps or bulges.
- If the glued part at the rear edge of the envelope is bent, it may cause poor paper feeding. Correct the bending before use.
- Duplex printing is not available.
- Always perform trial printing and check that there are no problems.

Label

- The toner may stick thinly to the whole paper or the printing may be light.
- The toner may be easily removed.
- The warps on the front edge of a label may cause poor paper feeding. Use labels after correcting warps or bulges.
- Duplex printing is not available.
- Always perform trial printing and check that there are no problems.

Long paper

- For thick paper, the toner may stick thinly to the whole paper or the printing may be light.
- If the paper grain direction does not match the paper feeding direction, paper jams may occur.
- Do not use paper that has been printed once with a thermal transfer printer, inkjet printer, etc.
- The paper wrapper shows the orientation of the surface. Load paper properly so that the face side is the printing side.
- The paper is wrapped in moisture-proof paper to prevent moisture. Please use the paper as early as possible after opening its package.
- If the paper has a GSM weight other than 128 g/m², the print quality may deteriorate. Always perform trial printing and check that there are no problems.
- Be sure to set the paper size to portrait length. The portrait length cannot be set to a value shorter than the landscape length.
- Some applications may not be available.
- Even when using under the recommended conditions, the long paper with a length exceeding 356 mm may not be able to guarantee the print quality.

Irregular-sized paper (custom size)

- Skewing, curling, warping, folded corners (the edge is folded) and paper jams caused by these factors may occur. Check the print result of the paper to be used in advance.
- Register the paper in portrait orientation and load it in portrait orientation in the tray.
- If the length exceeds 356 mm, use the rear output tray.
- Some applications may not be available.
- The quality of printing on the paper with a length exceeding 356 mm will be not guaranteed.
- If the paper is too long and protrudes from the paper supporter of the MP tray, support the paper with your hand.
- For the paper size that can be fed from each tray and the paper size that can be printed on both sides, please refer to "[Applicable paper](#)(P.72)".

- If you cannot print correctly on a large-sized paper, it is suggested to set [Quality] to [Normal] in the PS printer driver.
- Always perform trial printing and check that there are no problems.

Recycled

- The toner may stick thinly to the whole paper or the printing may be light.
- Some recycled paper contains additives that may reduce the printing quality. Be sure to check that it is the recycled paper for the electrophotographic printer before using it.

Paper applicable to each tray

Tray 1

Media type	Media size	Media weight	Applicable number of sheets
Plain Partially printed paper Colored paper	A4, A5, A6, B5, B6, Letter, Legal (13 inches), Legal (13.5 inches), Legal (14 inches), Executive, Statement, 8.5-inch SQ (8.5 x 8.5 inches), Folio (210 x 330 mm), 16K (184 x 260 mm), 16K (195 mm x 270 mm), 16K (197 x 273 mm), 5 x 7 inches, custom size (width: 100 - 216 mm; length: 148 - 356 mm)	60~256 g/m ²	250 (When the paper weight is 80 g/m ²)

Tray 2/3/4 (Optional)

Media type	Media size	Media weight	Applicable number of sheets
Plain Partially printed paper Colored paper	A4, A5, A6, B5, B6, Letter, Legal (13 inches), Legal (13.5 inches), Legal (14 inches), Executive, Statement, 8.5-inch SQ (8.5 x 8.5 inches), Folio (210 x 330 mm), 16K (184 x 260 mm), 16K (195 mm x 270 mm), 16K (197 x 273 mm), 5 x 7 inches, custom size (width: 105 - 216 mm; length: 148 - 356 mm)	64~176 g/m ²	530 (When the paper weight is 80 g/m ²)

MP tray

Media type	Media size	Media weight	Applicable number of sheets
Plain Envelope Label Index Card Partially printed paper Color paper	A4, A5, A6, B5, B6, B6 Half, B7, B8, Letter, Legal (13 inches), Legal (13.5 inches), Legal (14 inches), Executive, Statement, 8.5-inch SQ (8.5 x 8.5 inches), Folio (210 x 330 mm), 16K (184 x 260 mm), 16K (195 mm x 270 mm), 16K (197 x 273 mm), 4 x 6 inches, 5 x 7 inches, Com-9, Com-10, Monarch, DL, C5, custom size (width: 55 - 216 mm; length: 91 - 1,321 mm)	60~256 g/m ²	100 (When the paper weight is 80 g/m ²) 10 (When the envelope weight is 80g/m ²)

Loading paper in Tray 1

For the paper that can be used, please see "[Applicable paper\(P.72\)](#)", "[Paper applicable to each tray\(P.76\)](#)".



- You can load the A5-sized paper in either portrait or landscape.

1 Pull out the paper cassette.

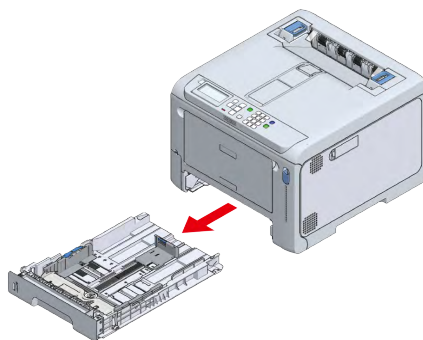

- If you pull out the paper cassette with the power on, "Change tray settings?" may appear on the display. This message will disappear automatically in 10 seconds after the paper cassette is returned to the main unit. If you have changed the paper, press the «OK» button and change the settings of paper size, media type and media weight accordingly.
- Be cautious for the orientation of paper that can be loaded in either portrait or landscape, like A5 size.

2 Slide the paper guide and the blue part of the paper stopper to fit the size of the paper to be loaded.

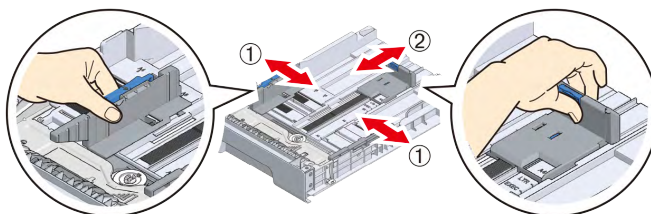

3 Shuffle the paper well. Align edges of the paper horizontally.

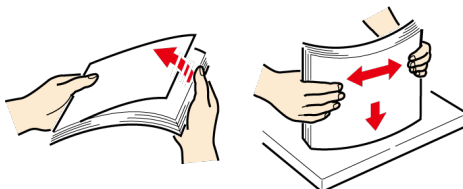

4 Load the paper with the printing side down, and press it down from top.



- Do not exceed the ▽ mark on the paper guide when loading paper.

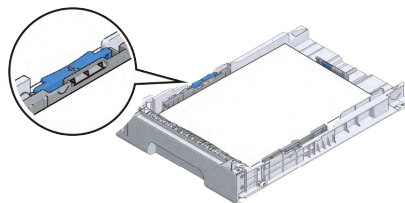

5 Return the paper cassette to this machine.



- If the paper cassette is returned to the main unit forcefully, the paper stopper may slide.

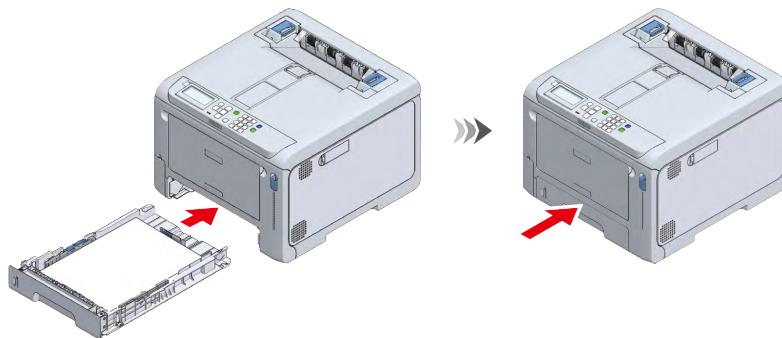

6 Proceed to "Setting paper information on the operator panel(P.81)".

Loading paper in Tray 2/3/4 (Optional)

For the paper that can be used, please see "Applicable paper(P.72)" , "Paper applicable to each tray(P.76)".



- You can load the A5-sized paper in either portrait or landscape.

1 Pull out the paper cassette.

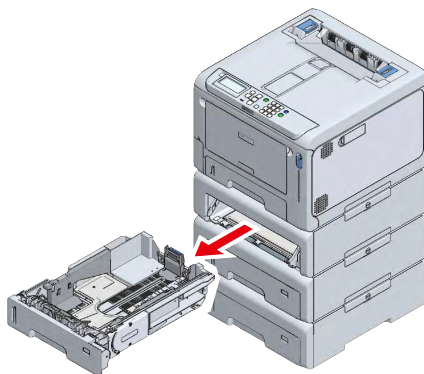

2 Set the paper size dial to fit the paper size.

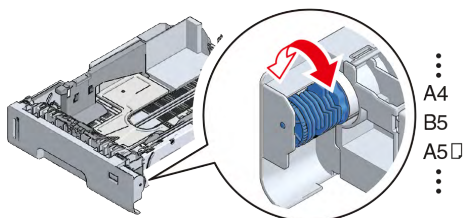

- Set it to [OTHER] when you have loaded the paper of a standard size not available on the paper size dial.



- If you pull out the paper cassette with the power on, "Change tray setting?" may appear on the display. This message will disappear automatically in 10 seconds after the paper cassette is returned to the main unit. If you have changed the paper, press [Yes] and change the settings of paper size, media type and media weight accordingly. Also, change the setting of the paper size dial of the tray.
- Make sure that the setting of the paper size dial matches the size of paper to be loaded. If they do not match, a paper size error will occur, and you will be unable to print.

- Be cautious for the orientation of paper that can be loaded in either portrait or landscape, like A5 size.

3 Slide the paper guide and the blue part of the paper stopper to fit the size of the paper to be loaded.

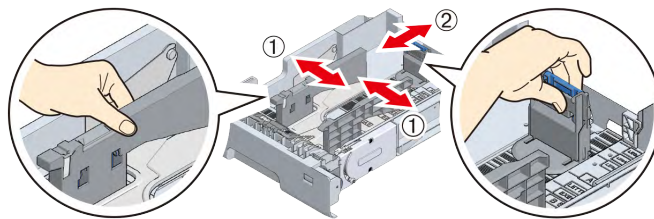

4 Shuffle the paper well. Align edges of the paper horizontally.

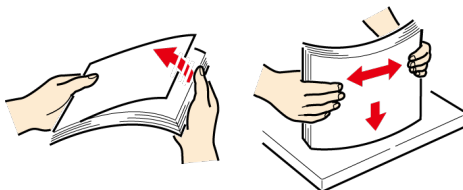

5 Load the paper with the printing side down, and press it down from top.



- Do not exceed the ▽ mark on the paper guide when loading paper.

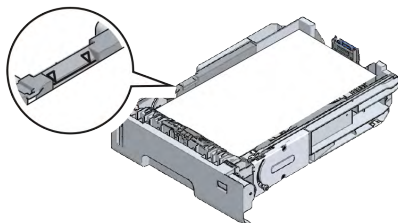

6 Check that the size and orientation of the loaded paper well match the settings of the paper size dial.



- If the size and the orientation of the loaded paper do not match the settings of the paper size dial, a paper size error may occur during printing and you may not be able to print.

7 Return the paper cassette to this machine.



- If the paper cassette is returned to the main unit forcefully, the paper stopper may slide.

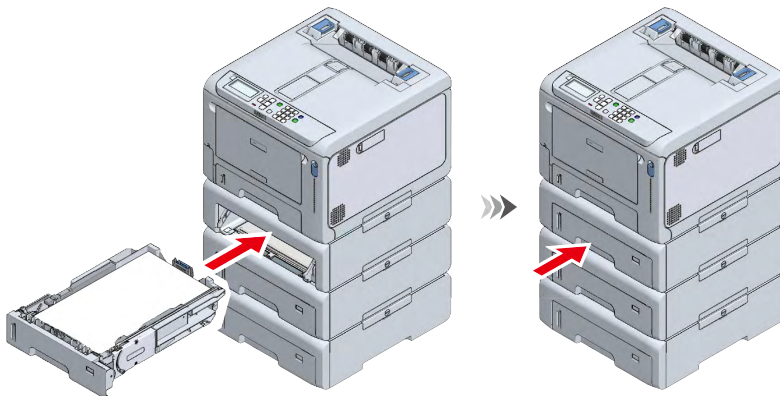

8 Proceed to "[Setting paper information on the operator panel\(P.81\)](#)".

Loading paper in the MP tray

For the paper that can be used, please see "[Applicable paper\(P.72\)](#)" and "[Paper applicable to each tray\(P.76\)](#)".



- Do not load paper of different sizes, types, and weight at the same time.
- When adding paper, remove the paper in the MP tray, align edges of the paper and the paper to be added, and then load them together.
- Do not insert anything other than print paper into the MP tray.
- Do not leave paper in the MP tray for an extended period of time. Dust and dirt will adhere to the paper, and the print quality will degrade.



- You can load the A5-sized paper in either portrait or landscape.

- 1 Place your fingers in the front recess and pull to open the MP tray towards you.

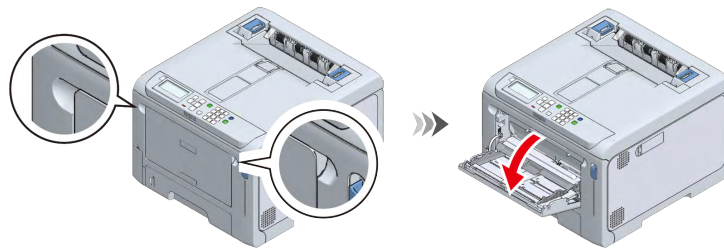

- 2 Hold the center of the paper supporter and pull it out towards you.

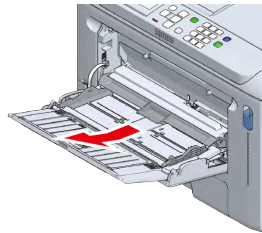

- 3 Open the auxiliary supporter.

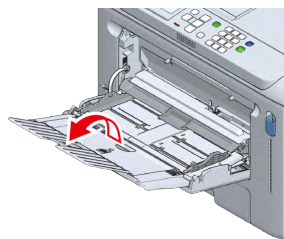

- 4 Move the paper placement cover upward.

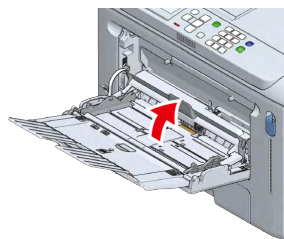

- 5 Adjust the manual feeder guide to the width of the paper to be loaded.

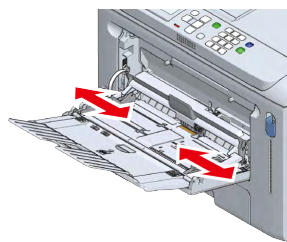

- 6 Shuffle the paper well. Align edges of the paper horizontally.

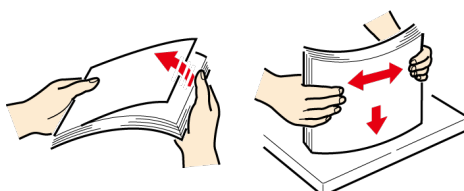

- 7 Load the paper with the print side facing up.



- Do not exceed the ▽ mark on the paper guide when loading paper.

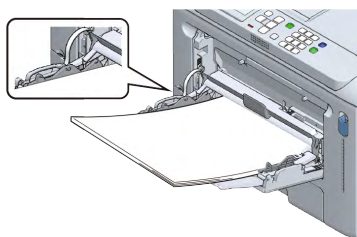

- "Would you like to change the tray settings?" may appear on the display. This message will disappear automatically after 10 seconds. If you have changed the paper, press «OK» and change the settings of paper size, media type and media weight accordingly.

- 8 Move the paper placement cover downward.



- The paper cannot be fed without lowering the paper placement cover.

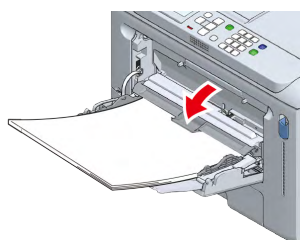

If you always print on paper of the same size and type from the MP tray, register the loaded paper in this machine.

Proceed to "[Setting paper information on the operator panel](#)(P.81)".

Setting paper information on the operator panel

Set the size, type and weight of the paper loaded in each tray in order.

When envelopes are loaded, see "[Printing on envelopes](#)(P.143)".

When labels are loaded, see "[Printing on labels](#)(P.145)".

When long paper is loaded, see "[Printing on long paper](#)(P.146)".

When irregular-sized paper is loaded, see "[Printing on irregular-sized paper \(custom size\)](#)(P.148)".



- If the machine is in the power save mode, press «POWER SAVE» to restore.
- For details about the short cut menu, see "[Setting with the short menu \(Fn key\)\(P.94\)](#)".

For Tray 1/the MP tray

- 1 Check that "Ready To Print" appears on the display.
- 2 To set the paper size of Tray 1, press the keys in the following order: «Fn» → «1» → «0» → «OK».
To set the paper size of the MP tray, press the keys in the following order: «Fn» → «9» → «0» → «OK».
- 3 Press the scroll button ▲ or ▼ to select the paper size to set, and press «OK» and then «BACK».
- 4 Press «2» to display [Media Type], press ▲ or ▼ to select the paper type to set, and press «OK» and then «BACK».
- 5 Press «3» to display [Media Weight], press ▲ or ▼ to select the paper type to set, and press «OK» and then «BACK».
- 6 Press «ON LINE» to return to the standby screen.

For Tray 2/3/4

- 1 Check that "Ready To Print" appears on the display.
- 2 To set the paper size of Tray 2, press the keys in the following order: «Fn» → «2» → «0» → «OK».
To set the paper size of Tray 3, press the keys in the following order: «Fn» → «3» → «0» → «OK».
To set the paper size of Tray 4, press the keys in the following order: «Fn» → «4» → «0» → «OK».
- 3 Press ▲ or ▼ to select [Cassette Size], and press «OK» and then «BACK».
- 4 If the paper size dial of the tray is set to any other option than [OTHER], proceed to Step 5.
If [OTHER] is set, press «4» to display [Other Size]. Press ▲ or ▼ to select the paper size to set, and press «OK» and then «BACK».
- 5 Press «2» to display [Media Type]. Press ▲ or ▼ to select the paper type to set, and press «OK» and then «BACK».
- 6 Press «3» to display [Media Weight]. Press ▲ or ▼ to select the paper type to set, and press «OK» and then «BACK».
- 7 Press «ON LINE» to return to the standby screen.

About values to be set

Refer to the following table for settings in the case of plain, partially printed paper and colored paper.

Values to be set on the operator panel	
Media type	Media weight
Plain	60 - 63 g/m ² paper: Ultra Light 64 - 74 g/m ² paper: Light 75 - 82 g/m ² paper: Medium Light 83 - 90 g/m ² paper: Medium 91 - 104 g/m ² paper: Medium Heavy 105 - 120 g/m ² paper: Heavy 121 - 176 g/m ² paper: Ultra Heavy 1 177 - 220 g/m ² paper: Ultra Heavy 2 221 - 256 g/m ² paper: Ultra Heavy 3

Refer to the following table for settings in the case of index cards.

Values to be set on the operator panel	
Paper size	Media weight
Index Card	60 - 63 g/m ² : Ultra Light 64 - 74 g/m ² : Light 75 - 82 g/m ² : Medium Light 83 - 90 g/m ² : Medium 91 - 104 g/m ² : Medium Heavy 105 - 120 g/m ² : Heavy 121 - 176 g/m ² : Ultra Heavy 1 177 - 220 g/m ² : Ultra Heavy 2 221 - 256 g/m ² : Ultra Heavy 3

Storing paper

Please keep the paper under the following conditions to maintain the quality.

- A dark and flat place with low humidity
- Temperature: 20°C
- Humidity: 50% RH (relative humidity)

Do not store in any of the following places.

- Places exposed to direct sunlight
- Places with extreme rises and sudden fluctuations in temperature
- Places near copiers, air conditioners, heaters, ducts, etc.
- Places near the inside of an outer wall
- Uneven or curved surfaces
- Directly on the floor
- Places where static electricity is generated



- Do not open the paper until you use it.
- Do not leave the paper exposed to the air for a long period of time. You may not be able to print correctly.
- Depending on the paper in use, operating conditions and storage conditions, the print quality may deteriorate, or the paper may be curled or wrinkled.

Setting the output bin

This machine outputs paper to the output tray or rear output tray. The following types of paper can be output to each output tray.

Output bin	Types of paper to output	Number of sheets to output
Output tray	Plain, recycled paper	150 (80 g/m ²)
Rear output tray	Plain, recycled paper, envelope, Index Card, labels, long paper	100 (80g/m ²) 10 (envelopes/card stocks)



- Do not open or close the output tray during printing. Doing so may cause a paper jam.

Output tray

The paper is output with the printing side down in the order in which they are printed.



- Check that the rear output tray at the back of this machine is closed. When the rear output tray is open, paper will always be output to the rear output tray.

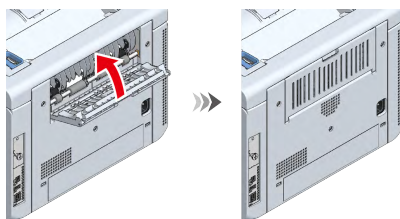

When the printed paper does not stack well, lift the paper supporter. There are two paper supporters, but only either of them is used according to your environment.

- When lifting the paper supporter on the front side

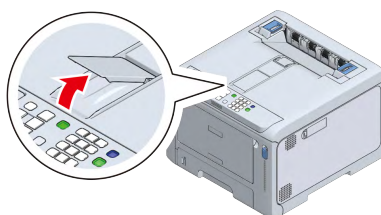

- When lifting the paper supporter on the back side

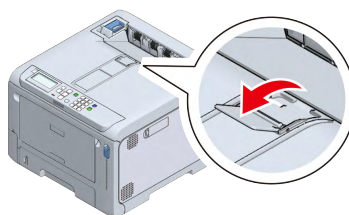

Rear output tray

Use the rear output tray to print on envelopes, labels or custom-sized paper.

The paper is output with the printing side up in the reverse order to which they are printed.

- 1 Open the rear output tray at the back of this machine.

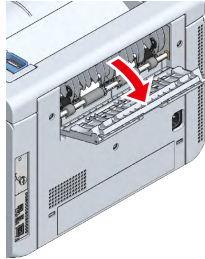

- 2 Open the paper supporter.

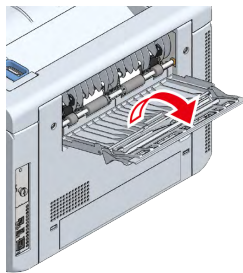

- 3 Pull out the auxiliary supporter.

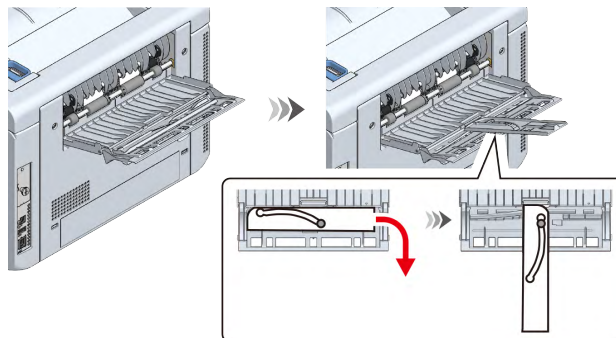

Checking the configuration

You can print out and check the configuration of this machine. You can also check the configuration from the operator panel.

Printing the menu map (configuration)

You can print the list of configurations (menu map) of this machine or the Printer Usage Report.

- 1 Check that "Ready To Print" appears on the display.



- If the machine is in the power save mode, press «POWER SAVE» to restore.

- 2 Press «Fn» on the operator panel.

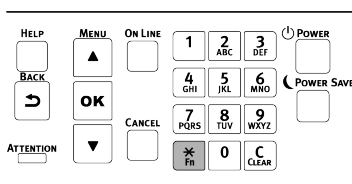

- 3 On the function number screen, press «1», «0», «0» and finally «OK».

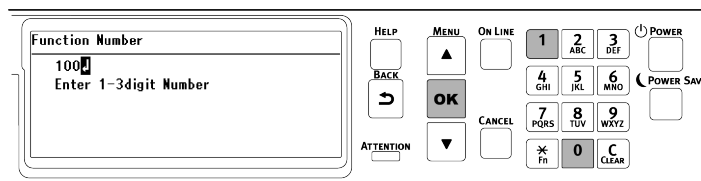

- 4 Make sure that [Configuration] is displayed and [Execute] is selected, and press «OK».

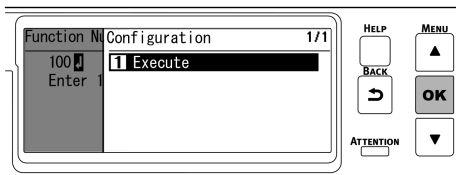

- 5 The configuration is printed .

How to read the configuration

A

Configuration
 Tray Count
 MPTray : 29
 Tray1 : 0
 Tray2 : 0
 Tray3 : 0
 Tray4 : 0
 Paper Feed Roller Counts

Configuration

MPTray : 29
 Tray1 : 0
 Tray2 : 0
 Tray3 : 0
 Tray4 : 0
 Paper Feed Roller Counts

B

Print Information
 Configuration (Fn100)
 Network (Fn101)
 File List
 PS Font List
 PCL Font List
 IBM PPR Font List
 EPSON FX Font List
 Usage Report (Fn102)
 Supplies Report
 Error Log (Fn103)
 Color Profile List
 CMYK TEST 1

A	Displays the options that have been installed.
B	Displays the function number. Setting with the short menu (Fn key)(P.94)



- For the information not listed in [Configuration], see "[Menu list\(P.102\)](#)" - [Print Information].

Confirming on the operator panel

You can check the supplies status and counter information on the operator panel.

- 1 Check that "Ready To Print" appears on the display.



- If the machine is in the power save mode, press «POWER SAVE» to restore.

- 2 Press the scroll button ▼ on the operator panel several times to select [Configuration], and press «OK».
- 3 Select the item that you want to check, and press «OK».
- 4 Select the information that you want to check, and press «OK».
- 5 After confirming the content, press «ON LINE» to return to the standby screen.

How to use levers L1 and L2

When the front cover is open, you will find the L1 lever and the L2 lever. This section describe how to use these levers.

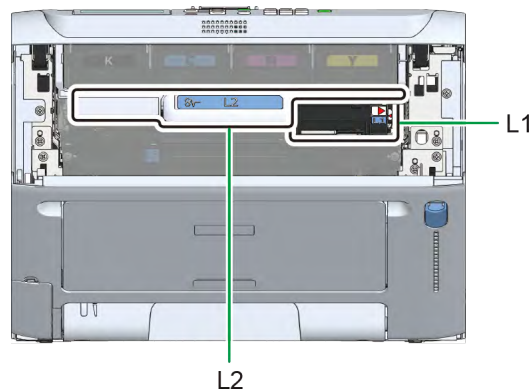

Lever L1

Used to replace the image drum and to clean the LED head.

[Replacing the image drum](#)(P.303)

[Cleaning the LED head](#)(P.312)

After opening the front cover, operate the L1 lever first and then the L2 lever.

After the operation, only the output tray is raised.

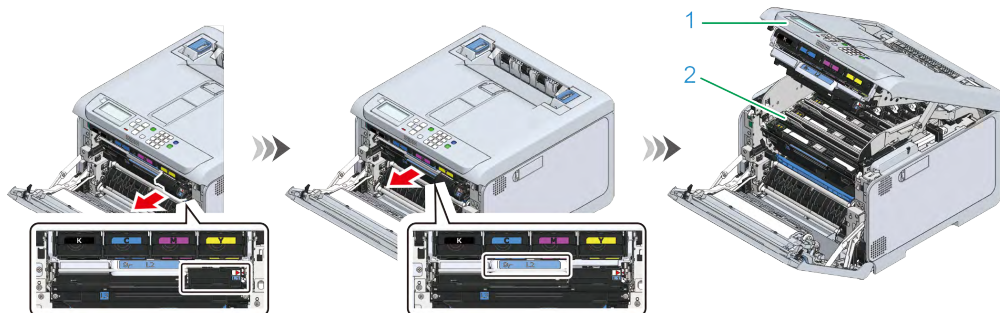

No.	Name
1	Output tray
2	Image drum basket

When closing, close the output tray first. Then, press the L1 lever, and close the front cover with your both hands firmly.

Lever L2

Used to replace the belt unit and to remove the jammed paper.

[Replacing the belt unit\(P.308\)](#)

[When paper is jammed\(P.337\)](#)

After opening the front cover, pull the L2 lever.

After the operation, both the output tray and the image drum basket are integrated and raised.

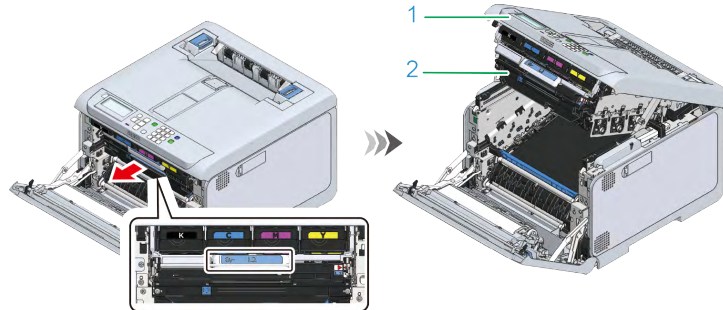

No.	Name
1	Output tray
2	Image drum basket

When closing, close the output tray first, and then close the front cover with your both hands firmly.

4

Changing settings from the operator panel

Parts identification of the operator panel.....	91
Adjusting the display orientation	92
Inputting text.....	93
Changing settings.....	94
Adjusting the buzzer volume	97
Setting the power save function	98
Menu list	102

Parts identification of the operator panel

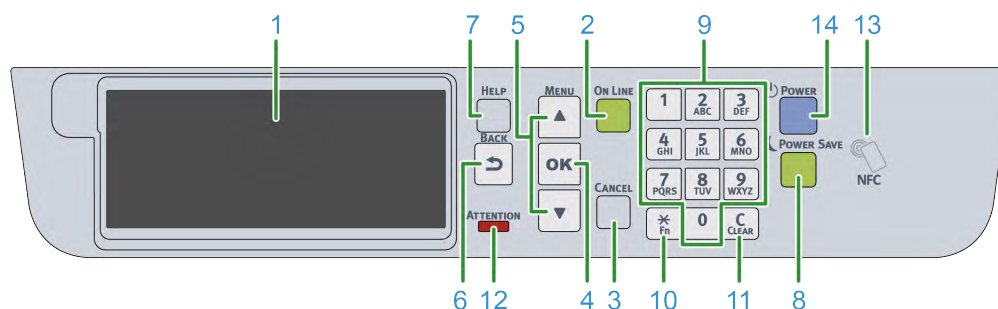

No.	Name	Function
1	Display	Displays the state of this machine and operation instructions. There are two types of standby screens: "Show Remaining Toner" and "Show Tray Information". The factory default setting is "Show Remaining Toner".
2	«ON LINE» button	Switches between online and offline. Lights green when online, and goes off when offline.
3	«CANCEL» button	Cancels the current printing. Goes back to the standby screen when the menu is displayed.
4	«OK» button	Confirms the highlighted item.
5	Scrolls buttons ▲▼	Used to select a menu or scroll the screen display. It can be used to input numbers in the numerical input screen.
6	«BACK» button	Goes back to the previous screen.
7	«HELP» button	Displays the help screen. To close the screen, press the «HELP» button again, or press the «BACK» or «CANCEL» button.
8	«POWER SAVE» button	Turns on or off the power save mode. Cancels the sleep mode. Lights green in the power save mode, and flashes green in the sleep mode.
9	Numeric keypad	Inputs alphanumeric characters or symbols.
10	«Fn» key	Used to display the short cut menu. Fn: The abbreviation for "Function".
11	«CLEAR» key	Long or short press the key to perform the following actions according to the item to input. <ul style="list-style-type: none"> Minimizes the settings. Inputs 0 for the settings. Deletes one character of the input text. Deletes the selected item. * Disabled when the IP address is input.
12	ATTENTION lamp	Indicates the state of this machine. Lights off in the normal state. On: Indicates that a minor error has occurred. Blinking: Indicates that a major error has occurred.
13	NFC mark	When using the NFC function, bring your mobile device close here. For details about the NFC function, see " Printing from a mobile device (P.286)".
14	Power switch	Turns on/off the power of this machine. Lights blue when the power is turned on, and lights off when the power is turned off.

Adjusting the display orientation

You can adjust the angle so that it is easier to watch the display.

- 1 Put your finger in the recess on the left side of the display, and raise the display towards you.

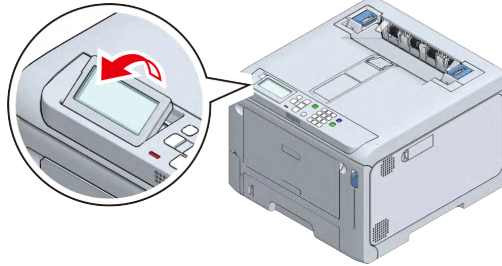

To return to the original angle, press it gently.

Inputting text

You can input alphabetic or numeric characters using the numeric keypad. If a same key is pressed in succession, the alphanumeric character will switch. To continue typing with the same key, press «OK» after inputting each alphanumeric character.

The following characters can be input when the corresponding key is pressed.

For a menu that can only input numbers, it will not switch to alphabetic characters.

Key	Text to input
«1»	1 → 1
«2»	2 → a → b → c → A → B → C → 2
«3»	3 → d → e → f → D → E → F → 3
«4»	4 → g → h → i → G → H → I → 4
«5»	5 → j → k → l → J → K → L → 5
«6»	6 → m → n → o → M → N → O → 6
«7»	7 → p → q → r → s → P → Q → R → S → 7
«8»	8 → t → u → v → T → U → V → 8
«9»	9 → w → x → y → z → W → X → Y → Z → 9
«0»	0 → (space) → 0
«*»	* → @ → . → _ → - → (space) → + → ! → " → \$ → % → & → ' → (→) → , → / → : → ; → < → = → > → ? →
«Fn»	[→ ¥ →] → ^ → # → ` → { → → } → ~ → *  <ul style="list-style-type: none"> If the setting value contains [+] and [-], you can switch between [+] and [-] by pressing it while you are inputting.

Example

To input "abc",

press «2» «2» «OK», «2» «2» «2» «OK», and «2» «2» «2»«2» «OK».

The functions of the following keys are described below.

«Fn»

Used to quickly display items of the Setting menu. When "Ready To Print" is displayed, press «Fn» and then the numeric key to display the menu item corresponding to the number.

[Setting with the short menu \(Fn key\)\(P.94\)](#)

«CLEAR»

Deletes each character individually when a password is input.

Changing settings

Setting menu display

This section describes how to change menu settings from the operator panel.



- See "[Menu list](#)(P.102)" for a list of menu items.

- 1 Check that "Ready To Print" appears on the display.



- If the machine is in the power save mode, press «POWER SAVE» to restore.

- 2 Press the scroll button ▲ or ▼ on the operator panel several times to select the category of the item to be set, and press «OK». Repeat until you see the category of the item to be set. The display color of the selected item is highlighted.

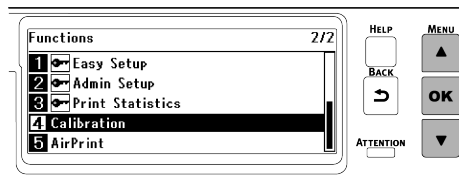

- 3 Press ▲ or ▼ several times to select the item to be set, and then press «OK».

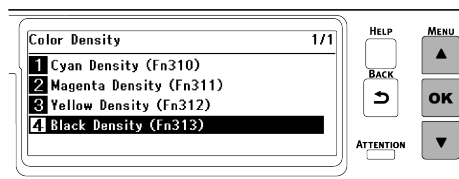

- 4 Use ▲/▼ or the numeric keypad to display the value to be set, and press «OK». A check mark appears to the left of the set value.

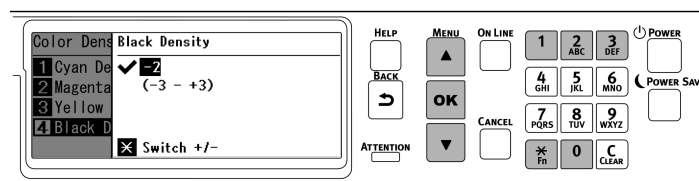

- 5 Press «ON LINE» to return to the standby screen.

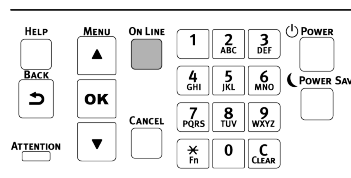

Setting with the short menu (Fn key)

When "Ready To Print" is displayed, press the «Fn» key on the operator panel, and then press any number to display the relevant menu item.



- For the number corresponding to the menu item, refer to "[Function Number List](#)".

- You can print to check the configuration.
 - [Printing the menu map \(configuration\)\(P.86\)](#)

1 Check that "Ready To Print" appears on the display.



- If the machine is in the power save mode, press «POWER SAVE» to restore.

2 Press «Fn» on the operator panel.

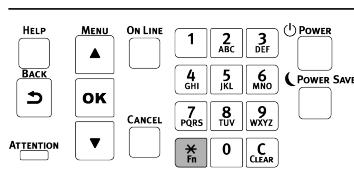

3 Since it will be a function number screen, input the number of the menu you want to display using the numeric keypad, and press «OK».

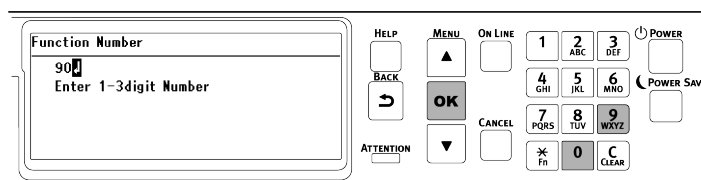

4 When the menu is displayed, check or change the settings.

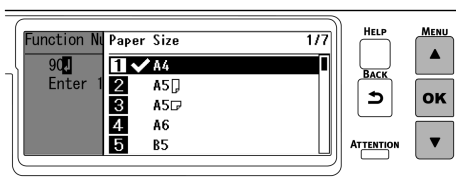

Function Number List

Function No.	Corresponding menu item
1	Shared Print (Stored Job)
2	Private Print (Encrypted Job)
10	Media Size (Tray 1)
11	X Dimension (Tray 1)
12	Y Dimension (Tray 1)
13	Media Type (Tray 1)
14	Media Weight (Tray 1)
20	Media Size (Tray 2)
21	X Dimension (Tray 2)
22	Y Dimension (Tray 2)
23	Media Type (Tray 2)
24	Media Weight (Tray 2)
30	Media Size (Tray 3)
31	X Dimension (Tray 3)
32	Y Dimension (Tray 3)
33	Media Type (Tray 3)
34	Media Weight (Tray 3)
40	Media Size (Tray 4)
41	X Dimension (Tray 4)
42	Y Dimension (Tray 4)

Function No.	Corresponding menu item
43	Media Type (Tray 4)
44	Media Weight (Tray 4)
80	Paper Tray
90	Media Size (MP tray)
91	X Dimension (MP tray)
92	Y Dimension (MP tray)
93	Media Type (MP tray)
94	Media Weight (MP tray)
95	Tray Usage (MP tray)
100	Print Information (Menu Map (Configurations))
101	Print Information (Network)
102	Print Information (Printer Usage Report)
103	Print Information (Error Log)
200	Power Save Time
201	Sleep Time
202	Auto Power Off Time
210	Error Report
220	Print Position Adjust (MP tray)
221	Print Position Adjust (Tray 1)
222	Print Position Adjust (Tray 2)
223	Print Position Adjust (Tray 3)
224	Print Position Adjust (Tray 4)
230	Paper Black Setting
231	Paper Color Setting
232	Trans. Black Setting
233	Trans. Color Setting
234	SMR Setting
235	BG Setting
236	Drum Cleaning
237	Hex Dump
300	Adjust Density
301	Adjust Registration
302	Print Color Tuning Pattern
310	Cyan Density
311	Magenta Density
312	Yellow Density
313	Black Density



- If the function number of an optional part that is not installed is specified, [Invalid Number] is displayed.



- For a list of menu items, see "[Menu list\(P.102\)](#)".

Adjusting the buzzer volume

The volume of the following buzzers is adjustable in three steps.

- Paper jam buzzer
- Printing completion buzzer
- Buzzer for AirPrint printing
- IC Card hold buzzer

- 1** Press the scroll button ▼ on the operator panel several times to select [Admin Setup], and press «OK».
- 2** Input the admin password using the numeric keypad, and press «OK».
[Admin password](#)(P.195)
- 3** Press ▼ or ▲ several times to select [Buzzer Setup], and press «OK».
- 4** Press ▼ or ▲ several times to select the item to change, and press «OK».
- 5** Adjust the volume of the selected item, and press «OK».
- 6** Press «ON LINE» to return to the standby screen.

Setting the power save function

Setting the time that elapses before entering the power save mode

This machine automatically enters the power save mode (an energy saving mode) if no operation is done for a certain period of time.

The following time can be set. The factory default setting is 1 minutes.

1 min, 2 mins, 3 mins, 4 mins, 5 mins, 10 mins, 15 mins, 30 mins, and 60 mins



- This machine may not enter the power save mode after the set period of time since the fan is working until this machine has cooled down depending on the printing environment or the usage conditions.

1 Check that "Ready To Print" appears on the display.



- If the machine is in the power save mode, press «POWER SAVE» to restore.

2 Press «Fn» on the operator panel.

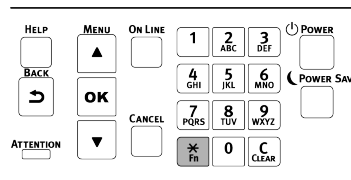

3 Input «2», «0» and «0» using the numeric keypad, and press «OK».

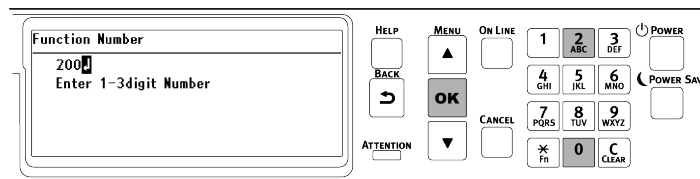

4 Press the scroll button ▲ or ▼ to select the time to set, and press «OK».

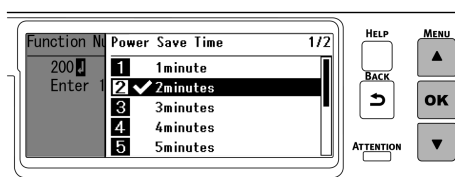

5 Press «ON LINE» to return to the standby screen.

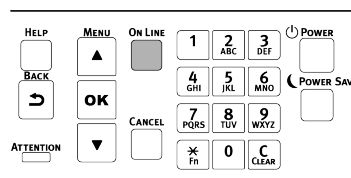

Setting the time that elapses before entering the sleep mode

This machine automatically enters the sleep mode (a more energy saving mode) if no operation is done for a certain period of time in the power save mode.

The following time can be set. The factory default setting is 15 minutes.

1 min, 2 mins, 3 mins, 4 mins, 5 mins, 10 mins, 15 mins, 30 mins, and 60 mins



- This machine may not enter the sleep mode after the set period of time since the fan is working until this machine has cooled down depending on the printing environment or the usage conditions.

1 Check that "Ready To Print" appears on the display.



- If the machine is in the power save mode, press «POWER SAVE» to restore.

2 Press «Fn» on the operator panel.

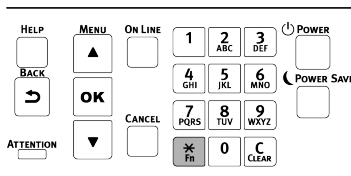

3 Input «2», «0» and «1» using the numeric keypad, and press «OK».

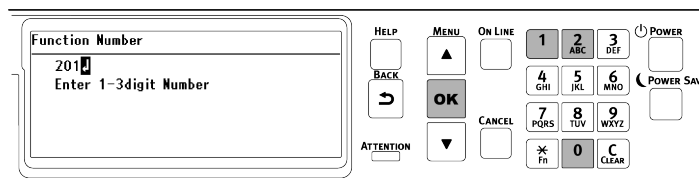

4 Press the scroll button ▲ or ▼ to select the time to set, and press «OK».

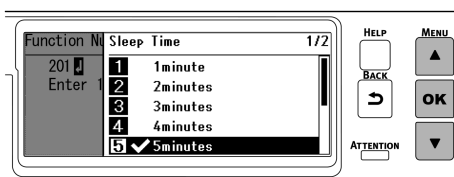

5 Press «ON LINE» to return to the standby screen.

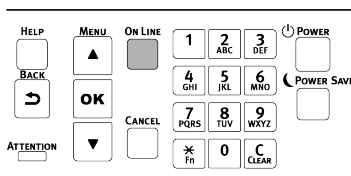

Restrictions of the power save function

The sleep mode will not be entered in the following cases.

- When an error has occurred to this machine
- When access control is enabled for the access control settings, and local IC card authentication or LDAP IC card authentication is enabled for the authentication method

Turning off the power automatically (Auto Power Off)

This machine comes with a function (Auto Power Off) to turn off the power automatically if it has not been used for a certain period of time.

There are 3 types of settings for Auto Power Off, and the default factory setting is [Auto Config].

- [Auto Config]: The power is turned off automatically if the machine has not been used for a certain period of time, except in the following situations.
 - When the LAN cable is connected to the network interface connector
 - When the wireless LAN is enabled
- [Enable]: The power is automatically turned off if this machine has not been used for a certain period of time.
- [Disable]: Disables the Auto Power Off function. The power does not turn off automatically.



- Auto Power Off does not work in the following cases.
 - With the factory default settings, Auto Power Off does not work when a network (wired/wireless) is connected.
 - When an error has occurred

Follow the procedure below to change the Auto Power Off setting.

1 Check that "Ready To Print" appears on the display.



- If the machine is in the power save mode, press «POWER SAVE» to restore.

2 Press the scroll button ▼ on the operator panel several times to select [Admin Setup], and press «OK».

3 Input the admin password using the numeric keypad, and press «OK».

[Admin password](#)(P.195)

4 Press ▼ several times to select [Power Setup], and press «OK».

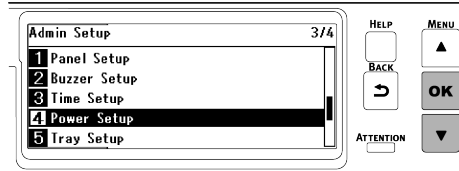

5 When [Auto Power Off] is displayed, press «OK».

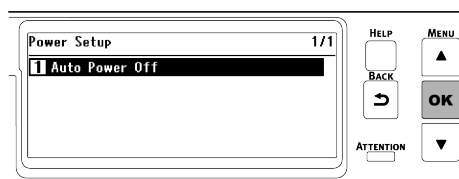

6 Press ▲ or ▼ to select [Auto Config], [Enable] or [Disable], and press «OK».

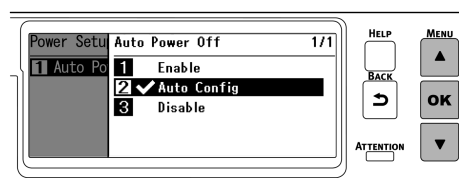

7 Press «ON LINE» to return to the standby screen.

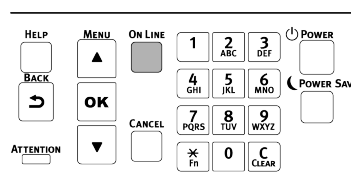

Setting the time that elapses before entering the auto power off mode

The following time can be set. The factory default setting is 4 hours.

1 hour, 2 hours, 3 hours, 4 hours, 8 hours, 12 hours, 18 hours, and 24 hours

1 Check that "Ready To Print" appears on the display.



- If the machine is in the power save mode, press «POWER SAVE» to restore.

2 Press «Fn» on the operator panel.

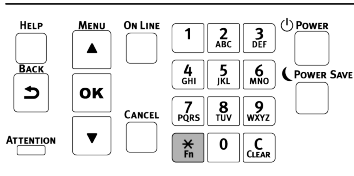

3 Input «2», «0» and «2» using the numeric keypad, and press «OK».

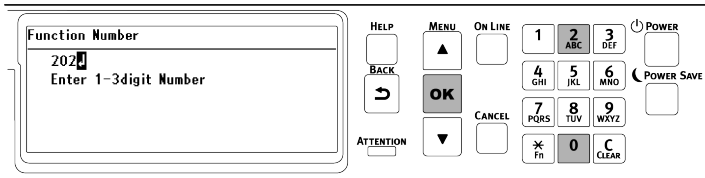

4 Press the scroll button ▲ or ▼ to select the time to set, and press «OK».

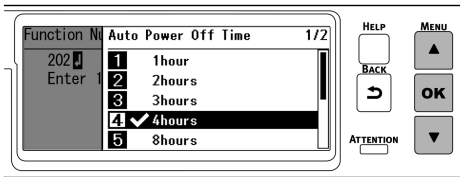

5 Press «ON LINE» to return to the standby screen.

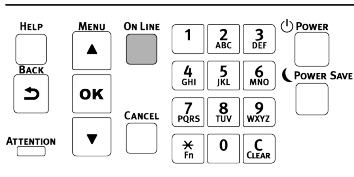

Menu list

You can print to check the menu list.

 [Printing the menu map \(configuration\)\(P.86\)](#)



- The following items are displayed when the wireless LAN module (optional) is installed.
 - AirPrint
 - Wireless(Infrastructure) Setting
 - Wireless(AP Mode) Setting

Print From USB Memory

Item		Factory default settings	Description	
Select Print File			Select the file to be printed.	
Print Setup	Paper Feed	Tray 1 (xx)	Specifies the paper feeding tray. (xx) is the size of the paper loaded in this tray.	
	Copies	1	Sets the number of copies to be printed.	
	Duplex	On or Off *1	Sets whether or not to implement duplex printing.	
	Binding	Long Edge	Sets the binding method for duplex printing.	
	Fit	On	Specifies whether to fit to the paper.	
	Color Mode	Color	Selects whether to print in color or mono.	
Barcode Print Setup	Repeat	1	Sets the number of copies to be printed.	
	Layout Rows	1	Sets the number of rows on each page.	
	Layout Columns	1	Sets the number of columns on each page.	
	Start Position	X Coordinate	5 millimeter	Sets the X coordinate of the start position (i.e. the direction perpendicular to the paper travel direction).
		Y Coordinate	30 millimeter	Sets the Y coordinate of the start position (i.e. the direction parallel to the paper travel direction).
	Spacing	X Spacing	5 millimeter	Sets the X spacing of the scheduled printing range of barcodes.
		Y Spacing	5 millimeter	Sets the Y spacing of the scheduled printing range of barcodes.
	Barcode Type	QRCode	Sets the type of barcodes.	
	Barcode Attribute	Error Correction Level	Low	Sets the error correction level of QRCode.
		Module Size	10 x 1.7 mils	Sets the module size of QRCode.
		Human Readable Character	None	Sets the attributes of 1D barcodes.
Bar Height		29 pixels	Sets the bar height.	
	Bar Width	8 x 1.7 mils	Sets the bar width.	

*1 Factory default setting values are different according to the country or region.

Configuration

Item			Description				
Tray Count			MPTray	Displays the total number of print pages for each tray. Trays 2 to 4 are displayed when optional expansion trays are mounted.			
			Tray1				
			Tray2				
			Tray3				
			Tray4				
Paper Feed Roller Counter			MPTray	Displays the number of sheets fed from each tray. Trays 2 to 4 are displayed when optional expansion trays are mounted.			
			Tray1				
			Tray2				
			Tray3				
			Tray4				
A4/Letter Impressions Count			Color	Displays the number of color printing sheets converted to A4/Letter paper.			
			Mono	Displays the number of mono printing sheets converted to A4/Letter paper.			
Supplies Life			Cyan Toner (n.nK)*	Displays the remaining toner amount (%) of each color. *: The display may vary with the type of toner cartridge installed.			
			Magenta Toner (n.nK)*				
			Yellow Toner (n.nK)*				
			Black Toner (n.nK)*				
						Cyan Drum	Displays the remaining service life (%) of image drum of each color.
						Magenta Drum	
						Yellow Drum	
						Black Drum	
						Belt	Displays the remaining service life (%) of the belt unit.
						Fuser	Displays the remaining service life (%) of the fuser unit.
Network	Network Information	General Information	Extended Network	Displays the enabled expanded network other than the standard wired LAN1.			
			Enabling Default Gateway	Displays the enabled default gateway.			
			Printer Name	Displays the printer name.			
			Short Printer Name	Displays the short printer name.			
			NIC Program Version	Displays the network firmware version.			
			Web Remote Version	Displays the web page version.			
			Wired(LAN1) Information	Wired(LAN1)	Displays the state (enabled/disabled) of the standard wired LAN1.		
		IPv4 Address	Displays the IP address of the wired network.				
		Subnet Mask	Displays the subnet mask.				
		Gateway Address	When [Enabling Default Gateway] is set to [Wired(LAN1)], the gateway address is displayed.				
	MAC Address	Displays the MAC address of the wired network.					
	IPv6 Address (Local)	Displays the IPv6 address (local).					

Item			Description
		IPv6 Address (Stateless Address)	Displays the IPv6 address (stateless).
		IPv6 Address (Stateful Address)	Displays the IPv6 address (stateful).
	Wireless(Infrastructure) Information * Displayed when the wireless LAN module (optional) is installed.	Firmware Version	Displays the wireless network firmware version.
		Wireless(Infrastructure)	Displays the state (enabled or disabled) of the wireless network (infrastructure).
		SSID	Displays the SSID of the connected wireless network access point.
		Security	Displays the security type of the wireless network connection.
		State	Displays the connection status of the wireless network.
		Band	Displays the frequency bands of the current wireless network.
		Channel	Displays the channel number used by the wireless network.
		RSSI	Displays the signal strength of the wireless network.
		IPv4 Address	Displays the IP address of the wireless network.
		Subnet Mask	Displays the subnet mask.
		Gateway Address	When the [Enabling Default Gateway] is set to [Wireless(Infrastructure)], the gateway address is displayed.
		MAC Address	Displays the MAC address of the wireless network.
		IPv6 Address (Local)	Displays the IPv6 address (local).
	IPv6 Address (Stateless Address)	Displays the IPv6 address (stateless).	
	IPv6 Address (Stateful Address)	Displays the IPv6 address (stateful).	
	Wireless(AP Mode) Information * Displayed when the wireless LAN module (optional) is installed.	Wireless (AP mode)	Displays the state (enabled or disabled) of the wireless network (AP mode).
		SSID	Displays the SSID of this machine.
		Password	Displays the password.
Number of connected		Displays the number of wireless terminals which are currently connected.	
IPv4 Address		Displays the IP address.	
System	Serial Number	Indicates the serial number of the printer.	
	Asset Number	Indicates the asset number of the printer.	
	Lot Number	Indicates the lot number of the printer.	
	Firmware Version	Indicates the version of firmware.	
	CU Version	Indicates the firmware version of the Control Unit (CU).	
	PU Version	Indicates the firmware version of the Print Unit (PU).	

Item		Description
	Panel Version	Indicates the firmware version of the operator panel.
	RAM	Indicates the total capacity of all RAM installed in this machine.
	Flash Memory	Indicates the total value capacity of all flash memories installed in this machine.
	Date and Time	Displays the current date and time.

Print Information

Item	Description
Configuration (Fn100)	Prints the configurations of the printer.
Network (Fn101)	Prints the setup situation of the network.
File List	Prints a list of files stored in the printer.
PS Font List	Prints the PS font sample.
PCL Font List	Prints the PCL font sample.
IBM PPR Font List	Prints the IBM PPR font sample.
EPSON FX Font List	Prints the EPSON FX font sample.
Usage Report (Fn102)	Prints the collective usage report of the printer.
Supplies Report	Prints the information such as the remaining service life of consumables.
Error Log (Fn103)	Prints the error log.
Color Profile List	Prints the list of color profiles registered in the printer.
Job Log	Prints the history of print data. Displayed when [Admin Setup] - [Others Setup] - [Job Log Setup] - [Save Job Log] is set to [Enable].
CMYK TEST1	Performs test print of each color with paper fed from the MP tray.

Print

Item		Description
Shared Print (Fn1)	---Print All---	Displayed when the shared print data is available. Prints all shared print data.
	---Delete All---	Displayed when the shared print data is available. Deletes all shared print data.
	(Displays a list of target files)	Displayed when the shared print data is available. Select a file, input the password, and start printing.
Private Print (Fn2)	Please select a User	Selects a user.
	Enter Password	Input the password for the selected user.
	Search all the Private Jobs?	Selects whether to search for print data of all users or personal print data (of the logged-in user).
	---Print All---	Prints all confidential print data.
	---Delete All---	Deletes all confidential print data.
	(Displays a list of target files)	Displayed when the confidential print data is available. Select a file, input the password, and start printing.

Menus

Item		Factory default settings	Description
Tray Configuration	MPTray Config	Paper Size (Fn90)	A4 or Letter *1 Sets the size of the paper you want to print on from the MP tray.
		X Dimension (Fn91)	210 millimeter or 8.5 inch *2 Sets the paper width when you have selected a custom size for the paper that you want to print on from the MP tray.

Item		Factory default settings	Description		
		Y Dimension (Fn92)	297 millimeter or 11.0 inch *2	Sets the paper length when you have selected a custom size for the paper that you want to print on from the MP tray.	
		Media Type (Fn93)	Plain	Sets the type of paper that you want to print on from the MP tray.	
		Media Weight (Fn94)	Light	Sets the weight of the paper that you want to print on from the MP tray.	
		Tray Usage (Fn95)	When Mismatching	Sets how to use the MP tray. The available values are as follows. [Normal Tray]: Treats the MP tray as a normal tray like Tray 1 or Trays 2-4 (optional). [When Mismatching]: Prints from the MP tray with the correct paper loaded when the paper loaded in the specified tray for printing is different from the paper size of the print data. [Do Not Use]: Ignores the MP tray in selecting or switching the tray automatically.	
	Tray1 Config		Paper Size (Fn10)	A4 or Letter *1	Sets the size of the paper you want to print on from Tray 1.
			X Dimension (Fn11)	210 millimeter or 8.5 inch *2	Sets the paper width when you have selected a custom size for the paper that you want to print on from Tray 1.
			Y Dimension (Fn12)	297 millimeter or 11.0 inch *2	Sets the paper length when you have selected a custom size for the paper that you want to print on from Tray 1.
			Media Type (Fn13)	Plain	Sets the type of the paper you want to print on from Tray 1.
			Media Weight (Fn14)	Light	Sets the weight of the paper you want to print on from Tray 1.
	Tray2 Config		Paper Size (Fn20)	Cassette Size	Sets the size of the paper you want to print on from Tray 2. For [Cassette Size], follows the settings of the paper size dial of the paper tray.
			X Dimension (Fn21)	210 millimeter or 8.5 inch *2	Sets the paper width when you have selected a custom size for the paper that you want to print on from Tray 2.
			Y Dimension (Fn22)	297 millimeter or 11.0 inch *2	Sets the paper length when you have selected a custom size for the paper that you want to print on from Tray 2.
			Media Type (Fn23)	Plain	Sets the type of the paper you want to print on from Tray 2.
		Media Weight (Fn24)	Light	Sets the weight of the paper you want to print on from Tray 2.	
		Other Size	A5[LEF]	Specifies the paper size when the paper size dial of Tray 2 is set to [OTHER].	
Tray3 Config		Paper Size (Fn30)	Cassette Size	Sets the size of the paper you want to print on from Tray 3. For [Cassette Size], follows the settings of the paper size dial of the paper tray.	

Item		Factory default settings	Description
		X Dimension (Fn31)	210 millimeter or 8.5 inch *2 Sets the paper width when you have selected a custom size for the paper that you want to print on from Tray 3.
		Y Dimension (Fn32)	297 millimeter or 11.0 inch *2 Sets the paper length when you have selected a custom size for the paper that you want to print on from Tray 3.
		Media Type (Fn33)	Plain Sets the type of the paper you want to print on from Tray 3.
		Media Weight (Fn34)	Light Sets the weight of the paper you want to print on from Tray 3.
		Other Size	A5[LEF] Specifies the paper size when the paper size dial of Tray 3 is set to [OTHER].
	Tray4 Config	Paper Size (Fn40)	Cassette Size Sets the size of the paper you want to print on from Tray 4. For [Cassette Size], follows the settings of the paper size dial of the paper tray.
		X Dimension (Fn41)	210 millimeter or 8.5 inch *2 Sets the paper width when you have selected a custom size for the paper that you want to print on from Tray 4.
		Y Dimension (Fn42)	297 millimeter or 11.0 inch *2 Sets the paper length when you have selected a custom size for the paper that you want to print on from Tray 4.
		Media Type (Fn43)	Plain Sets the type of the paper you want to print on from Tray 4.
		Media Weight (Fn44)	Light Sets the weight of the paper you want to print on from Tray 4.
		Other Size	A5 [LEF] Specifies the paper size when the paper size dial of Tray 4 is set to [OTHER].
	Paper Feed (Fn80)	Tray1	Specifies the paper feeding tray. The settings of the printer driver take priority.
	Auto Tray Switch	On	Sets whether or not to use the auto tray switch function. The settings of the printer driver take priority.
	Tray Sequence	Down	Specifies the selection order of the tray when the auto tray selection or auto tray switching function is used.
	Duplex Last Page	Skip Blank Page	Sets whether or not to print the last 1-sided page when the duplex printing is done on odd-numbered pages.
System Adjust	Power Save Time (Fn200)	1minute	Sets the time that will elapse before the power save mode is entered. Value range: 1 minute, 2 minutes, 3 minutes, 4 minutes, 5 minutes, 10 minutes, 15 minutes, 30 minutes, 60 minutes
	Sleep Time (Fn200)	15minutes	Sets the time that will elapse before the sleep mode is switched from the power save mode. Value range: 1 minute, 2 minutes, 3 minutes, 4 minutes, 5 minutes, 10 minutes, 15 minutes, 30 minutes, 60 minutes

Item	Factory default settings	Description
	Auto Power Off Time (Fn202)	4hours Sets the time that will elapse before the power is turned off automatically after the standby mode is entered. Value range: 1 hour, 2 hours, 3 hours, 4 hours, 8 hours, 12 hours, 18 hours, 24 hours
	Silent Mode	On Specifies the printing preparations when the standby mode is switched from the sleep mode. [On]: Silent due to no preparation for printing. [Off]: The image drum makes a noise as it prepares for printing, facilitating a faster speed for the first printing start time.
	Clearable Warning	ONLINE Sets the timing to clear the recoverable error display.
	Auto Continue	Off Sets whether or not to automatically restore this machine when a memory overflow or tray request occurs.
	Manual Timeout	60 seconds Sets the waiting time for loading the paper when you print with [Feed paper individually] checked in the printer driver. Value range: Off, 30 seconds, 60 seconds
	Timeout Injob	40 seconds Sets the time from loss of the data receipt (canceled by PostScript) until force-printing. Value range: Off, 5 seconds, 10 seconds, 20 seconds, 30 seconds, 40 seconds, 50 seconds, 60 seconds, 90 seconds, 120 seconds, 150 seconds, 180 seconds, 210 seconds, 240 seconds, 270 seconds, 300 Seconds
	Timeout Local	40 seconds Sets the time to keep each port open after printing. (Except for network) The value range is from 0 to 300 seconds in increments of 5 seconds.
	Timeout Network	90 seconds Sets the time to keep the network port open after printing. The value range is from 0 to 300 seconds in increments of 5 seconds.
	Low Toner	Continue Sets the action of this machine when [Toner Low] is displayed. This machine goes offline when [Stop] is selected.
	Print Mode w/o Color Toner	Alarm Specifies the action when there is an empty color toner cartridge. [Alarm]: This machine stops without printing the color print data. Replace the empty toner cartridge with a new one. [Cancel]: Cancels color print data automatically. Replace the empty toner cartridge with a new one.

Item		Factory default settings	Description		
	Jam Recovery	On	Sets whether to reprint pages not printed due to a paper jam after the paper jam is cleared. When [Off] is selected, the printing process including pages missed due to the paper jam will be canceled.		
	Error Report (Fn210)	Off	Sets whether to print an error report when an internal error occurs.		
	Hex Dump (Fn237)	Execute	Prints the data received from the PC in hexadecimal dump. To exit this mode, turn off the power.		
Print Adjust	Print Position Adjust	MPTray (Fn220)	X Adjust	0.00millimeter	Adjusts the printing position of each tray. • X Adjust: Corrects the position of the entire print image perpendicularly to the paper travel direction. Value range: ± 2.00 mm (in increments of 0.25 mm) • Y Adjust: Corrects the position of the entire print image along the paper travel direction. Value range: ± 2.00 mm (in increments of 0.25 mm) • Duplex X Adjust: Corrects the position of the entire print image at the right angle to the paper travel direction for printing the face side during duplex printing (when printing the print side of paper fed from the duplex unit). Value range: ± 2.00 mm (in increments of 0.25 mm) • Duplex Y Adjust: Corrects the position of the entire print image along the paper travel direction for printing the face side during duplex printing (when printing the print side of paper fed from the duplex unit). Value range: ± 2.00 mm (in increments of 0.25 mm) Tray 2/3/4 is displayed when the expansion tray is mounted.
			Y Adjust	0.00millimeter	
			Duplex X Adjust	0.00millimeter	
			Duplex Y Adjust	0.00millimeter	
		Tray1 (Fn221)	X Adjust	0.00millimeter	
			Y Adjust	0.00millimeter	
			Duplex X Adjust	0.00millimeter	
			Duplex Y Adjust	0.00millimeter	
		Tray2 (Fn222)	X Adjust	0.00millimeter	
			Y Adjust	0.00millimeter	
			Duplex X Adjust	0.00millimeter	
			Duplex Y Adjust	0.00millimeter	
		Tray3 (Fn223)	X Adjust	0.00millimeter	
			Y Adjust	0.00millimeter	
			Duplex X Adjust	0.00millimeter	
			Duplex Y Adjust	0.00millimeter	
Tray4 (Fn224)	X Adjust	0.00millimeter			
	Y Adjust	0.00millimeter			
	Duplex X Adjust	0.00millimeter			
	Duplex Y Adjust	0.00millimeter			

Item		Factory default settings	Description
Paper Black Setting (Fn230)		0	Used for fine adjustment in case of noticeable blur etc. in the print results during mono printing when [Plain] is selected as [Media Type]. Decreases the value if printing such as scattered or snow-covered printing occurs in high-density printing. Increases the value if printing is blurred. Adjusts within the range of ± 2 .
Paper Color Setting (Fn231)		0	Used for fine adjustment in case of noticeable blur etc. in the print results during color printing when [Plain] is selected as [Media Type]. Decreases the value if printing such as scattered or snow-covered printing occurs in high-density printing. Increases the value if printing is blurred. Adjusts within the range of ± 2 .
Trans. Black Setting (Fn232)		0	Used for fine adjustment in case of noticeable blur etc. in the print results during mono printing when [Transparency] is selected as [Media Type]. Decreases the value if printing such as scattered or snow-covered printing occurs in high-density printing. Increases the value if printing is blurred. Adjusts within the range of ± 2 .
Trans. Color Setting (Fn233)		0	Used for fine adjustment in case of noticeable blur etc. in the print results during color printing when [Transparency] is selected as [Media Type]. Decreases the value if printing such as scattered or snow-covered printing occurs in high-density printing. Increases the value if printing is blurred. Adjusts within the range of ± 2 .
SMR Setting (Fn234)	Cyan	0	Corrects printing variations for each color due to differences in temperature and humidity environments, printing density/printing frequency. Changes the value if there is burr in the image. Adjusts within the range of ± 3 .
	Magenta	0	
	Yellow	0	
	Black	0	
BG Setting (Fn235)	Cyan	0	Corrects printing variations for each color due to differences in temperature and humidity environments, printing density/printing frequency. Change the value if the underlay is dark. Adjusts within the range of ± 3 .
	Magenta	0	
	Yellow	0	
	Black	0	
HU Setting		Off	Sets the mode to remove the dirt due to leaving this machine idle for a long period of time.
VL Cleaning		Execute	Improves the printing result when there are white streaks in the vertical direction.
Gloss Mode		Off	A mode used to print with an increased fixing temperature and improved gloss. Please select [On] when you want to print more glossy.

Item	Factory default settings	Description
Drum Cleaning (Fn236)	Off	Sets to empty the drum before printing when white streaks appear in the horizontal direction. When it is turned on, the remaining service life of the image drum will be shortened.
High Humid Mode	Off	<p>The paper may curl when the paper is ejected at a high humidity. Set this setting to [Mode1] or [Mode2] to reduce the curling effect.</p> <p>Try [Mode2] if [Mode1] does not reduce the paper curling effect.</p> <p>The printing time is longer than the case of [Off].</p> <p>When [Mode1] or [Mode2] is set, the service life of the image drum will be shortened.</p>
Office Document Mode	Mode1	<p>In the case of Mode 1, toner is saved according to the setting of [Admin Setup] - [Print Setup] - [Toner Save] - [Toner Save Level].</p> <p>In the case of Mode 2, if [Toner Save Level] is set to [Off], toner is saved by 5%. When [Toner Save Level] is set to [Low], [Middle] or [High], toner is saved according to the settings.</p>
Moisture Control	Off	Enables/Disables the moisture control. When [Mode1] or [Mode2] is set, it is possible to prevent the paper from absorbing moisture at high humidity and prevent the paper from getting wet. It may take much time to print the first page.

Item	Factory default settings	Description
Narrow Paper Speed	Mode1	<p>Sets the printing speed when narrow paper is used.</p> <p>The target paper weight ranges from Ultra Light to Medium.</p> <p>Mode1: The recommend mode for massive printing on narrow paper (with a width of 182 mm or less).</p> <p>Switches the speed to a low speed when printing on narrow paper.</p> <p>Mode2: The recommend mode for printing on a small amount of narrow paper. Prints on narrow paper without reducing the speed. When printing on a large amount of narrow paper, it is easier to begin the waiting time for fixing temperature adjustment.</p> <p>Mode3: To print on wide paper after printing a large amount of narrow paper, poor printing may occur at the edge of paper. In this case, this mode is recommended to reduce the poor printing.</p> <p>To start printing on wide paper after printing on narrow paper, the waiting time for fixing temperature adjustment may be available. Switches the speed to a low speed when printing on narrow paper.</p>
Quiet Mode	Off	Sets the quiet print mode to reduce the noise during printing. The print speed becomes lower when [On] is set.
Ultra Light Paper Care Mode	Off	<p>If the following phenomena occur when you are printing with [Media Weight] set to [Ultra Light] or [Light], setting it to [On] may improve the situation. But, the printing speed becomes lower.</p> <ul style="list-style-type: none"> • Thin stripes appear along the paper travel direction. • An after-image is printed on either the top, bottom, left or right side of light-colored texts or images, about 94 mm apart.
Low Coverage Mode	Off	When used in a hot and humid environment, setting this when vertical band or vertical streaks-like blur appear on the edges of the paper may improve the print result.
Low Temp. Mode	Off	<p>Set to idle the drum and belt so that they operate stably when color registration is noticeable in a low temperature environment.</p> <p>When it is turned [On], the remaining service life of the image drum will be shortened.</p>

*1 Factory default setting values are different according to the country or region.

*2 The values are displayed with the unit set in [Admin Setup] - [Tray Setup] - [Unit of Measurement].

Easy Setup

Item		Factory default settings	Description	
Enter Password		*****	Input the password required to enter the Admin Setup menu.	
Language Setup	Select Language	English	Selects the display language of the display.	
Time Setup	Date Format	yyyy/mm/dd	Sets the date in the format of yyyy/mm/dd.	
	Time Zone	+9:00	Sets the GMT time zone. Value range: -12:00 to +13:00 (in increments of 15 minutes)	
	Daylight Saving	Off	Sets the daylight saving (daylight saving time).	
	Setting method	Manual Setup	Selects how to set the time.	
	SNTP Server (Primary)	(Blank)	Sets the SNTP server used to set the current date and time. Up to 64 characters can be used. Displayed when [Auto Config] is selected as the setting method.	
	SNTP Server (Secondary)	(Blank)		
	Time Setting	2001/01/01 00:00:00	The time is set at factory delivery. Change the date and time if necessary. Displayed when [Manual Setup] is selected as the setting method.	
Admin Password	New Password		Input a new admin password.	
	Verify Password		Input the new admin password again to verify.	
Network Setup	General Setup	Extended Network	Disable	Selected when you want to enable any other network than the standard wired LAN.
		Enabling Default Gateway	Wired(LAN1)	Specifies the network connection method for segment-based communication.
		TCP/IP	Enable	Enables/Disables the wired LAN.
		NetBIOS over TCP	Enable	Enables/Disables the NetBIOS over TCP protocol.
		Web	Enable	Enables the access from the web browser. Displayed when the TCP/IP protocol is enabled.
		Telnet	Disable	Enables the access using Telnet. Displayed when the TCP/IP protocol is enabled.
		FTP	Disable	Enables the access via FTP. Displayed when the TCP/IP protocol is enabled.
		IPSec	Disable	Displayed only when IPSec is enabled. It can be changed to Disable only. Displayed when the TCP/IP protocol is enabled.
		SNMP	Enable	Enables the access from SNMP. Displayed when the TCP/IP protocol is enabled.

Item		Factory default settings	Description	
		Network Scale	Small	Normally, [Small] is selected.
		Network Factory Defaults	Execute	Restores network menu settings to factory default settings.
	Wired(LAN1) Setup	Wired(LAN1)	Enable	Enables/Disables the wired LAN1.
		IP Address Set	Auto	Set to obtain the IPv4 address automatically or input it manually.
		IPv4 Address	xxx.xxx.xxx.xx	Input the IPv4 address manually. Displayed when [IP Address Set] is set to [Manual].
		Subnet Mask	xxx.xxx.xxx.xx	Input the subnet mask. Displayed when [IP Address Set] is set to [Manual].
		Gateway Address	xxx.xxx.xxx.xx	Input the gateway address. Displayed when [IP Address Set] is set to [Manual].
		DHCPv6	Disable	Set to obtain the IPv6 address automatically. Set to [Disable] when you do not use the IPv6 address.
		HUB Link Setting	Auto Negotiate	Sets the connection method to the hub.
System Adjust	Power Save Time (Fn200)		1minute	Sets the time that will elapse before the power save mode is entered. Value range: 1 minute, 2 minutes, 3 minutes, 4 minutes, 5 minutes, 10 minutes, 15 minutes, 30 minutes, 60 minutes
	Sleep Time (Fn200)		15minute	Sets the time that will elapse before the sleep mode is switched from the power save mode. Value range: 1 minute, 2 minutes, 3 minutes, 4 minutes, 5 minutes, 10 minutes, 15 minutes, 30 minutes, 60 minutes
	Auto Power Off Time (Fn202)		4hours	Sets the time that will elapse before the power is turned off automatically after the standby mode is entered. Value range: 1 hour, 2 hours, 3 hours, 4 hours, 8 hours, 12 hours, 18 hours, 24 hours
	Silent Mode		On	Specifies the printing preparations when the standby mode is switched from the sleep mode. [On]: Silent due to no preparation for printing. [Off]: The image drum makes a noise as it prepares for printing, facilitating a faster speed for the first printing start time.
	Clearable Warning		ONLINE	Sets the timing to clear the recoverable error display.
	Auto Continue		Off	Sets whether or not to automatically restore this machine when a memory overflow or tray request occurs.
	Manual Timeout		60seconds	Sets the waiting time for loading the paper when you print with [Feed paper individually] checked in the printer driver. Value range: Off, 30 seconds, 60 seconds

Item		Factory default settings	Description	
	Timeout Injob	40seconds	Sets the time from loss of the data receipt (canceled by PostScript) until force-printing. Value range: Off, 5 seconds, 10 seconds, 20 seconds, 30 seconds, 40 seconds, 50 seconds, 60 seconds, 90 seconds, 120 seconds, 150 seconds, 180 seconds, 210 seconds, 240 seconds, 270 seconds, 300 Seconds	
	Timeout Local	40seconds	Sets the time to keep each port open after printing. (Except for network) The value range is from 0 to 300 seconds in increments of 5 seconds.	
	Timeout Network	90seconds	Sets the time to keep the network port open after printing. The value range is from 0 to 300 seconds in increments of 5 seconds.	
	Low Toner	Continue	Sets the action of this machine when "Toner Low" is displayed. This machine goes offline when [Stop] is selected.	
	Print Mode w/o Color Toner	Alarm	Specifies the action when there is an empty color toner cartridge. [Alarm]: This machine stops without printing the color print data. Replace the empty toner cartridge with a new one. [Cancel]: Cancels color print data automatically. Replace the empty toner cartridge with a new one.	
	Jam Recovery	On	Sets whether to reprint pages not printed due to a paper jam after the paper jam is cleared. When [Off] is selected, the printing process including pages missed due to the paper jam will be canceled.	
	Error Report (Fn210)	Off	Sets whether to print an error report when an internal error occurs.	
	Hex Dump (Fn237)	Execute	Prints the data received from the PC in hexadecimal dump. To exit this mode, turn off the power.	
Tray Configuration	MPTray Config	Paper Size (Fn90)	A4 or Letter *1	Sets the size of the paper you want to print on from the MP tray.
		X Dimension (Fn91)	210 millimeter or 8.5 inch *2	Sets the paper width when you have selected a custom size for the paper that you want to print on from the MP tray.
		Y Dimension (Fn92)	297 millimeter or 11.0 inch *2	Sets the paper width when you have selected a custom size for the paper that you want to print on from the MP tray.
		Media Type (Fn93)	Plain	Sets the type of paper that you want to print on from the MP tray.
		Media Weight (Fn94)	Light	Sets the weight of the paper that you want to print on from the MP tray.

Item		Factory default settings	Description
	Tray Usage (Fn95)	When Mismatching	Sets how to use the MP tray. The available values are as follows. [Normal Tray]: Treats the MP tray as a normal tray like Tray 1 or Trays 2 - 4 (optional). [When Mismatching]: Prints from the MP tray with the correct paper loaded when the paper loaded in the specified tray for printing is different from the paper size of the print data. [Do Not Use]: Ignores the MP tray in selecting or switching the tray automatically.
Tray1 Config	Paper Size (Fn10)	A4 or Letter *1	Sets the size of the paper you want to print on from Tray 1.
	X Dimension (Fn11)	210 millimeter or 8.5 inch *2	Sets the paper width when you have selected a custom size for the paper that you want to print on from Tray 1.
	Y Dimension (Fn12)	297 millimeter or 11.0 inch *2	Sets the paper length when you have selected a custom size for the paper that you want to print on from Tray 1.
	Media Type (Fn13)	Plain	Sets the type of the paper you want to print on from Tray 1.
	Media Weight (Fn14)	Light	Sets the weight of the paper you want to print on from Tray 1.
Tray2 Config	Paper Size (Fn20)	Cassette Size	Sets the size of the paper you want to print on from Tray 2. For [Cassette Size], follows the settings of the paper size dial of the paper tray.
	X Dimension (Fn21)	210 millimeter or 8.5 inch *2	Sets the paper width when you have selected a custom size for the paper that you want to print on from Tray 2.
	Y Dimension (Fn22)	297 millimeter or 11.0 inch *2	Sets the paper length when you have selected a custom size for the paper that you want to print on from Tray 2.
	Media Type (Fn23)	Plain	Sets the type of the paper you want to print on from Tray 2.
	Media Weight (Fn24)	Light	Sets the weight of the paper you want to print on from Tray 2.
	Other Size	A5 [LEF]	Specifies the paper size when the paper size dial of Tray 2 is set to [OTHER].
Tray3 Config	Paper Size (Fn30)	Cassette Size	Sets the size of the paper you want to print on from Tray 3. For [Cassette Size], follows the settings of the paper size dial of the paper tray.
	X Dimension (Fn31)	210 millimeter or 8.5 inch *2	Sets the paper width when you have selected a custom size for the paper that you want to print on from Tray 3.
	Y Dimension (Fn32)	297 millimeter or 11.0 inch *2	Sets the paper length when you have selected a custom size for the paper that you want to print on from Tray 3.
	Media Type (Fn33)	Plain	Sets the type of the paper you want to print on from Tray 3.

Item		Factory default settings	Description		
		Media Weight (Fn34)	Light	Sets the weight of the paper you want to print on from Tray 3.	
		Other Size	A5 [LEF]	Specifies the paper size when the paper size dial of Tray 3 is set to [OTHER].	
	Tray4 Config		Paper Size (Fn40)	Cassette Size	Sets the size of the paper you want to print on from Tray 4. For [Cassette Size], follows the settings of the paper size dial of the paper tray.
			X Dimension (Fn41)	210 millimeter or 8.5 inch *2	Sets the paper width when you have selected a custom size for the paper that you want to print on from Tray 4.
			Y Dimension (Fn42)	297 millimeter or 11.0 inch *2	Sets the paper length when you have selected a custom size for the paper that you want to print on from Tray 4.
			Media Type (Fn43)	Plain	Sets the type of the paper you want to print on from Tray 4.
			Media Weight (Fn44)	Light	Sets the weight of the paper you want to print on from Tray 4.
			Other Size	A5 [LEF]	Specifies the paper size when the paper size dial of Tray 4 is set to [OTHER].
			Paper Feed (Fn80)	Tray1	Specifies the paper feeding tray. The settings of the printer driver take priority.
		Auto Tray Switch	On	Sets whether or not to use the auto tray switch function. The settings of the printer driver take priority.	
		Tray Sequence	Down	Specifies the selection order of the tray when the auto tray selection or auto tray switching function is used.	
	Duplex Last Page	Skip Blank Page	Sets whether or not to print the last 1-sided page when the duplex printing is done on odd-numbered pages.		
Wireless(Infr astructure) Setting	Wireless(Infrastructure)		Disable	Switches the state (enabled or disabled) of the wireless(Infrastructure).	
	Network Setting	IP Address Set		Auto	Set to obtain the IPv4 address automatically or set it manually.
		IPv4 Address		192.168.101.100	Input the IPv4 address manually. Displayed when [IP Address Set] is set to [Manual].
		Subnet Mask		255.255.255.0	Input the subnet mask. Displayed when [IP Address Set] is set to [Manual].
		Gateway Address		0.0.0.0	Input the gateway address. Displayed when [IP Address Set] is set to [Manual].
		DHCPv6		Disable	Set to obtain the IPv6 address automatically. Set to Disable when you do not use the IPv6 address.
	Automatic setup (WPS)	WPS-PBC			Executed when setting is done by pressing the WPS button of the wireless LAN access point.
		WPS-PIN			Executed when the PIN code displayed on this machine is registered with the wireless LAN access point.

Item			Factory default settings	Description
Wireless Network Selection	xxxxxx			Displays a list of wireless LAN access point names found by the search.
	Manual Setup	SSID		Input the SSID.
		Security	Disable	Sets the security of the wireless LAN function.
		WEP Key		Input the WEP key.
		WPA Encryption Type		Displays the WPA-PSK encryption type. The setting is carried out automatically according to the security settings. (Impossible to switch in this menu)
		WPA Pre-shared Key		Input the pre-shared key. Displayed when [Security] is set to any other value than [Disable] or [WEP].
	Execute		Executes the changes to security settings.	
Wireless Reconnection				Reconnects to the wireless LAN (infrastructure).

*1 Factory default setting values are different according to the country or region.

*2 The values are displayed with the unit set in [Admin Setup] - [Tray Setup] - [Unit of Measurement].

Admin Setup

Item			Factory default settings	Description
Enter Password			*****	Input the password required to enter the Admin Setup menu.
Network Setup	General Setup	Extended Network	Disable	Selected when you want to enable any other network than the standard wired LAN.
		Enabling Default Gateway	Wired(LAN1)	Specify the network connection method for segment-based communication.
		TCP/IP	Enable	Enables/Disables the wired LAN.
		NetBIOS over TCP	Enable	Enables/Disables the NetBIOS over TCP protocol.
		Web	Enable	Enables the access from the web browser. Displayed when the TCP/IP protocol is enabled.
		Telnet	Disable	Enables the access using Telnet. Displayed when the TCP/IP protocol is enabled.
		FTP	Disable	Enables the access via FTP. Displayed when the TCP/IP protocol is enabled.
		IPSec	Disable	Displayed only when IPSec is enabled. It can be changed to Disable only. Displayed when the TCP/IP protocol is enabled.
		SNMP	Enable	Enables the access from SNMP. Displayed when the TCP/IP protocol is enabled.
		Network Scale	Small	Normally, [Small] is selected.
Network Factory Defaults			Execute	Restores network menu settings to factory default settings.

Item		Factory default settings	Description
Wired(LAN1) Setup	Wired(LAN1)	Enable	Enables/Disables the wired LAN1.
	IP Address Set	Auto	Set to obtain the IPv4 address automatically or input it manually.
	IPv4 Address	xxx.xxx.xxx.xx	Input the IPv4 address manually. Displayed when [IP Address Set] is set to [Manual].
	Subnet Mask	xxx.xxx.xxx.xx	Input the subnet mask. Displayed when [IP Address Set] is set to [Manual].
	Gateway Address	xxx.xxx.xxx.xx	Input the gateway address. Displayed when [IP Address Set] is set to [Manual].
	DHCPv6	Disable	Set to obtain the IPv6 address automatically. Set to [Disable] when you do not use the IPv6 address.
	HUB Link Setting	Auto Negotiate	Sets the connection method to the hub.
USB Setup	USB	Enable	Enables/Disables the USB interface.
	Speed	480 Mbps	Sets the maximum baud rate using a USB interface.
	Soft Reset	Disable	Enables/Disables the soft reset command.
	Serial Number	Enable	Enables/Disables the USB serial number. The USB serial number is used to identify the USB device connected to the PC.
	Offline Receive	Disable	When [Enable] is selected, data can be received even if the printer is offline.
	USB Memory Interface	Enable	Enables/Disables the USB memory interface.
	Connected Host	Normal	Set to [Specific] in case of timeout when printing is done on this machine which is in the sleep mode. Power consumption in the sleep mode is higher than the state where it is set to [Normal].
Print Setup	Personality	Auto	Selects the operating language of the printer.
	Copies	1	Sets the number of copies. The value set in the printer driver takes priority.
	Duplex	On or Off *1	Sets whether or not to implement duplex printing. The value set in the printer driver takes priority.
	Binding	Long Edge	Specifies the binding method for duplex printing. The value set in the printer driver takes priority.
	Media Check	Enable	Sets whether to check the mismatch between the paper size of the print data and that of the tray.
	A4/Letter Override	Yes	Sets the functions of auto switching the printing paper from A4 to Letter when A4 paper runs out and Letter paper is loaded, or from Letter to A4 when Letter paper runs out.

Item		Factory default settings	Description	
	Resolution	600 dpi	Sets the resolution. The value set in the printer driver takes priority.	
	Toner Save	Toner Save Level	Off	Sets the toner save level.
		Color	All	Specifies whether to apply toner save to 100% black.
	Mono-Print Mode	Auto	Sets the print mode of mono pages. [Auto] controls the print mode with a good balance. [Color Mode] is suitable for printing a large amount of color pages. [Normal Mode] is suitable for printing a large amount of mono pages. Changing mono print mode(P.171)	
	Color Ready Mode	Off	Sets whether or not to prepare for the next color printing after the printing has completed.	
	Default Orientation	Portrait	Specifies the print orientation. For PostScript, this setting is disabled.	
	Edit Size	Cassette Size	Sets the size of the drawing area when the size is not specified by the paper size edit command from a PC.	
	Trapping	Off	Set when white streaks appear between adjacent colors.	
	X Dimension	210 millimeter	Sets the default value of paper width for custom paper sizes.	
	Y Dimension	297 millimeter	Sets the default value of paper length for custom paper sizes.	
PS Setup	L1 Tray	Type1	Sets the tray selection number of PostScript level-1 operator commands.	
	Network Protocol	RAW	Specifies the PS communication protocol for network connection.	
	USB Protocol	RAW	Specifies the PS communication protocol for USB connection.	
	PDF Paper Size	Current Tray Size	Specifies the paper size for direct printing of PDF files.	
	PDF Scaling Size	99%	Set the reduction ratio when [Scaling Size] is selected in [PDF Paper Size].	
	PDF Print Mode	Quality priority	Sets whether to prioritize print quality or print speed when a PDF is printed.	
PCL Setup	Font Source	Resident2	Selects the location of the font to be used.	
	Font Number	C1	Selects the number of the font to be used. Value range: I0 to I90 when [Resident] is set; or C1 to C4 when [Resident2] is set	
	Font Pitch	10.00 CPI	Sets the PCL font width. Value range: 0.44 to 99.99 CPI (in increments of 0.01 CPI)	
	Font Height	12.00 points	Sets the PCL font height. Value range: 4.00 to 999.75 points (in increments of 0.25 points)	
	Symbol Set	WIN3.1J	Selects the symbol set of PCL.	
	A4 Print Width	78 column	Sets the number of columns until an auto carriage return on A4 paper.	

Item		Factory default settings	Description
	White Page Skip	Off	Selects whether or not to print blank pages.
	CR Function	CR	Sets the operation of this machine when receiving a CR code.
	LF Function	LF	Sets the operation of this machine when receiving an LF code.
	Print Margin	Normal	Sets the unprintable area of the paper.
	True Black	Off	Sets whether to use composite black (CMYK mixed color) or pure black (K only) for the black color (100%) of image data.
	Pen Width Adjust	On	Sets whether to emphasize fine lines and make them thicker.
	Tray ID#	MPTray	4
	Tray1	1	
	Tray2	5	
	Tray3	20	
	Tray4	21	
SIDM Setup	SIDM Manual ID#	2	Sets up Pn specified in MANUAL by MANUAL-1 ID No.FX/PPR Emu in CSF control command (ESC EM Pn).
	SIDM Manual2 ID#	3	Sets up Pn specified in MANUAL by MANUAL-2 ID No.FX/PPR Emu in CSF control command (ESC EM Pn).
	SIDM MP Tray ID#	4	Sets up Pn specified TRAYO (MP Tray) by MP Tray ID No.FX/PPR Emu in CSF control command (ESC EM Pn).
	SIDM Tray1 ID#	1	Sets up Pn specified TRAY 1 by Tray 1 ID No.FX/ PPR Emu in CSF control command (ESC EM Pn).
	SIDM Tray2 ID#	5	Sets up Pn specified TRAY 2 by Tray 2 ID No.FX/ PPR Emu in CSF control command (ESC EM Pn).
	SIDM Tray3 ID#	6	Sets up Pn specified TRAY 3 by Tray 3 ID No.FX/ PPR Emu in CSF control command (ESC EM Pn).
	SIDM Tray4 ID#	7	Sets up Pn specified TRAY 4 by Tray 4 ID No.FX/ PPR Emu in CSF control command (ESC EM Pn).
IBM PPR Setup	Character Pitch	10 CPI	Specifies character pitches in IBM PPR emulation.
	Font Condense	12 CPI to 20 CPI	Specifies 12CPI pitches for Condense Mode.
	Character Set	SET-2	Specifies a character set.
	Symbol Set	IBM-437	Specifies a symbol set.
	Letter O Style	Disable	Specifies the style that replaces 9BH with letter o and 9DH with a zero.
	Zero Character	Normal	Sets the zero to be slashed or unslashed.
	Line Pitch	6 LPI	Specifies the line spacing.
	White Page Skip	Off	Selects whether to print blank pages.
	CR Function	CR	Selects a carriage return from [CR] or [CR+LF].
	LF Function	LF	Selects a line feed from [LF] or [LF+CR].
	Line Length	80 Column	Specifies the number of characters per line.

	Item	Factory default settings	Description
	Form Length	11.7 inch or 11 inch *1	Specifies the length of paper.
	TOF Position	0.0 inch	Specifies the distance from the top edge of paper.
	Left Margin	0.0 inch	Specifies the distance from the left edge of paper so that the print starting point shifts to the right horizontally.
	Fit to Letter	Disable or Enable *1	Sets the printing mode that can fit paper to the printable area equivalent to 11 inches (66 lines).
	Text Height	Same	Sets the height of a character. Same: The height stays the same regardless of CPI. Diff: The height varies according to CPI.
EPSON FX Setup	Character Pitch	10 CPI	Specifies character pitch.
	Character Set	SET-2	Specifies a character set.
	Symbol Set	IBM-437	Specifies a symbol set.
	Letter O Style	Disable	Specifies the style that replaces 9BH with letter o and 9DH with a zero.
	Zero Character	Normal	Sets the zero to be slashed or unslashed.
	Line Pitch	6 LPI	Specifies the line spacing.
	White Page Skip	OFF	Selects whether to print blank pages.
	CR Function	CR	Select a carriage return from [CR] or [CR+LF].
	Line Length	80 Column	Specifies the number of characters per line.
	Form Length	11.7 inch or 11 inch *1	Specifies the length of paper.
	TOF Position	0.0 inch	Specifies the distance from the top edge of paper.
	Left Margin	0.0 inch	Specifies the distance from the left edge of paper so that the print starting point shifts to the right horizontally.
	Fit To Letter	Disable or Enable *1	Sets the printing mode that can fit paper to the printable area equivalent to 11 inches (66 lines).
	Text Height	Same	Sets the height of a character. Same: The height stays the same regardless of CPI. Diff: The height varies according to CPI.
Private Print Setup	Verify job option	Disable	Specifies whether to verify the print data before printing. If enabled, printing is performed after verifying that the print data has not been changed. The integrity of print data is guaranteed, but the time to start printing will be longer.

	Item	Factory default settings	Description
	Erase job option	No overwrite	Sets the method for erasing the print data. Specifies that the data cannot be overwritten after it has been erased and cannot be restored. If you overwrite, it will take longer to erase. Value range: No overwrite/Zero out once
	Keep job for	2hours	Sets the retention period of the print data. After the print data is saved, if the print data is not printed after the set period, the print data is automatically deleted. Value range: 15 min/30 min/1 hour/2 hours/4 hours/8 hours/12 hours/1 day/2 days/3 days/4 days/5 days/6 days/7 days
	Job Limitation	Enable all print formats	Sets whether to save restricted print data. When [Private Print only] is selected, print data other than private print will not be accepted.
	Verify job password	Off	Selects whether to verify the job password when the access control is enabled.
	Job Auto Search	On	Selects whether to perform job search at the same time as unlocking the panel when the access control is enabled.
Color Setup	Ink Simulation	Off	The printer comes with a built-in process simulation tool that simulates standard printing colors on the printer.
	UCR	Low	Adjusts the degree of under color removal.
	CMY100% Density	Disable	Selects whether to use halftone for C, M, Y 100% output.
	CMYK Conversion	On	Selects whether to perform CMYK conversion in the simple (high speed) mode.
Panel Setup	Near Life Status	Enable	Sets whether to display a message when the supplies or maintenance parts are approaching the end of service life.
	Near Life LED	Enable	Sets whether to light the «ATTENTION» lamp when the supplies or maintenance parts are approaching the end of service life.
	Idle display	Toner Gauge	Selects the information to be displayed on the standby screen.
	Panel Contrast	0	Adjusts the contrast of the display. Value range: -10 to +10
Buzzer Setup	Error Volume	Off	Sets the buzzer volume when an error occurs.
	Print Completion Buzzer Volume	Off	Sets the buzzer volume when the printing has completed.
	AirPrint Buzzer Volume	Low	Sets the volume of the AirPrint buzzer.
	Card Hold Buzzer Volume	Low	Sets the buzzer volume when the IC card is held. Displayed when access control is enabled.
Time Setup	Date Format	yyyy/mm/dd	Sets the date in the format of yyyy/mm/dd.
	Time Zone	+9:00	Sets the GMT time zone. Value range: -12:00 to +13:00 (in increments of 15 minutes)

Item		Factory default settings	Description	
	Daylight Saving	Off	Sets the daylight saving (daylight saving time).	
	Setting method	Manual Setup	Selects how to set the time.	
	SNTP Server(Primary)	(Blank)	Sets the SNTP server used to set the current date and time. Up to 64 characters can be used. Displayed when [Auto Setup] is selected as the setting method.	
	SNTP Server(Secondary)	(Blank)		
	Time Setting	2001/01/01 00:00:00	The time is set at factory delivery. Change the date and time if necessary. Displayed when [Manual Setup] is selected as the setting method.	
Power Setup	Auto Power Off	Auto Config	Sets the operation of Auto Power Off. Auto Config: Auto Power Off does not work for network (wired/wireless) connection. Enable: Auto Power Off works regardless of the connection method. Disable: Auto Power Off does not work.	
Tray Setup	Unit of Measurement	millimeter	Sets the unit of measurement for the custom size (mm/inch).	
	Default Paper Size	A4	Sets the default paper size of a custom size.	
Others Setup	Paper Feed Roller Counter Clear	MP Tray Clear	Execute	Clears the counter after the paper feed roller of the MP tray is replaced.
		Tray1 Clear	Execute	Clears the counter after the paper feed roller Tray 1 is replaced.
		Tray2 Clear	Execute	Clears the counter after the paper feed roller Tray 2 is replaced.
		Tray3 Clear	Execute	Clears the counter after the paper feed roller Tray 3 is replaced.
		Tray4 Clear	Execute	Clears the counter after the paper feed roller Tray 4 is replaced.
	Flash Memory Setup	Initialize	Execute	Initializes the flash memory.
		Format Partition	PCL	Formats the specified partition of a flash memory.
	Job Log Setup	Save Job Log	Disable	Sets whether to save a log of print data.
		Clear Job Log	Execute	Clears the log of saved print data. Displayed when [Save Job Log] is enabled.
	Security Setup	Access Control	Disable	Sets whether to enable access control.
		User Counter Report	Execute	Prints a user counter report. Displayed when access control is set to [Enable] and [Save Job Log] is enabled.
Language Setup	Select Language	English	Selects the display language of the display.	

Item		Factory default settings	Description
Job Cancel Setup	Cancel Key Behavior	Short	Sets the actions when the cancel button is pressed. Short: A short press (for 2 seconds or less) cancels the printing. Long: A long press for 2 to 5 seconds cancels the printing. Off: Pressing the cancel button does not cancel the printing.
	Inquiry Display	On	Sets whether to display a screen to confirm whether to cancel the printing.
	Focus Position	Yes	Sets whether to select [Yes] or [No] as the default on the job cancel inquiry screen.
	Display Timeout	180	Sets the waiting time in seconds before a button is pressed on the job cancel inquiry screen. When the waiting time has passed, the printing will be continued instead of being canceled.
Near Life Setup	Drum Near Life Timing	1500	Sets whether to display the number of copies before the image drum is approaching the end of its service life. Value range: 500 to 5,000 (in increments of 500)
	Fuser Near Life Timing	1500	Sets whether to display the number of copies before the fuser unit is approaching the end of its service life. Value range: 500 to 5,000 (in increments of 500)
	Belt Near Life Timing	1500	Sets whether to display the number of copies before the belt unit is approaching the end of its service life. Value range: 500 to 5,000 (in increments of 500)
Erase Privacy Data		Execute	Erases the following data set in this machine. • Admin password, values set in various menus • Various records • Access control registered to this machine, user information
NFC Setup		Enable	Enables/Disables the NFC function.
Settings	Reset Settings	Execute	Resets the menu settings changed by the user to the factory default settings.
	Save Settings	Execute	Saves the current menu settings. Menu settings that have been saved previously will be overwritten.
	Restore Settings	Execute	Restores settings to the saved menu settings.
Change Password	New Password	-	Input a new admin password.
	Verify Password	-	Input the new admin password again to verify.

*1 Factory default setting values are different according to the country or region.

Print Statistics

Item		Factory default settings	Description
Enter Password		****	Input the password required to enter the Print Statistics menu. The input range is a 4-digit number. The factory default setting is "0000".
Usage Report		Enable	Enables/Disables the usage report.
Maintenance Counter		Disable	Sets whether or not to add a maintenance report (non-resettable counter and non-resettable consumables replacement times) to [Usage Report]. [Disable]: Prints the resettable counter and resettable consumable replacement counter in [Usage Report]. [Enable]: In addition to resettable counter and resettable consumable replacement counter, the maintenance report (non-resettable counter and non-resettable consumable replacement counter) is also printed together in [Usage Report]. Displayed when [Print Statistics] - [Usage Report] is set to [Enable].
Reset Main Counter		Execute	Resets the main counter. Displayed when [Print Statistics] - [Usage Report] is set to [Enable].
Reset Supplies Counter		Execute	Resets the replacement counter of consumables. Maintenance counter is not reset. Displayed when [Print Statistics] - [Usage Report] is set to [Enable] and [Maintenance Counter] is set to [Enable].
Change Password	New Password	****	Sets a new password required to enter the Print Statistics menu. The input range is a 4-digit number. Displayed when [Print Statistics] - [Usage Report] is set to [Enable].
	Verify Password	****	Input the new password required to enter the Print Statistics menu set in [New Password] again.

Calibration

Item		Factory default settings	Description
Auto Density Mode		Standard	Sets whether to automatically adjust the density/tone for color printing. Or, changes the frequency to adjust the density/tone for color printing.
Adjust Density (Fn300)		Execute	Executed when you want to adjust the density immediately.
Adjust Registration (Fn301)		Execute	Executed when you want to adjust the registration immediately.
Long Paper Adjust		0	Adjusts the fixing speed for printing on long paper. Set to a plus value if color shift occurs, or to a minus value if color misregistration occurs.

Item		Factory default settings	Description
Color Density	Cyan Density (Fn310)	0	Sets the print density for each color. Adjusts within the range of ± 3 . Darkens the print result by adjusting in + direction, or lightens the print result by adjusting in - direction.
	Magenta Density (Fn311)	0	
	Yellow Density (Fn312)	0	
	Black Density (Fn313)	0	
Print Color Tuning Pattern (Fn302)		Execute	Prints a pattern for density adjustment.
Cyan Tuning	Highlight	0	Adjusts the density of highlights (light areas), mid-tone and dark tone (dark areas) for each color. Darkens the density by adjusting in the plus direction, and lightens the density by adjusting in the minus direction. Used for fine adjustment that is not possible with the density setting. Adjusts within the range of ± 3 .
	Mid-Tone	0	
	Dark	0	
Magenta Tuning	Highlight	0	
	Mid-Tone	0	
	Dark	0	
Yellow Tuning	Highlight	0	
	Mid-Tone	0	
	Dark	0	
Black Tuning	Highlight	0	
	Mid-Tone	0	
	Dark	0	

AirPrint

Item	Factory default settings	Description
AirPrint	Enable	Sets AirPrint to [Enable].

Wireless(Infrastructure) Setting

Item		Factory default settings	Description
Enter Password		*****	Input the password required to enter the Admin Setup menu.
Wireless(Infrastructure)		Disable	Enables/Disables the wireless LAN (infrastructure).
Network Setting	IP Address Set	Auto	Set to obtain the IPv4 address automatically or input it manually.
	IPv4 Address	192.168.101.100	Input the IPv4 address manually. Displayed when [IP Address Set] is set to [Manual].
	Subnet Mask	255.255.255.0	Input the subnet mask. Displayed when [IP Address Set] is set to [Manual].
	Gateway Address	0.0.0.0	Input the gateway address. Displayed when [IP Address Set] is set to [Manual].
	DHCPv6	Disable	Set to obtain the IPv6 address automatically. Set to disable when you do not use the IPv6 address.
Automatic setup (WPS)	WPS-PBC		Executed when setting is done by pressing the WPS button of the wireless LAN access point.
	WPS-PIN		Executed when the PIN code displayed on this machine is registered with the wireless LAN access point.
Wireless Network Selection	xxxxxx		Displays the list of wireless LAN access points detected by this machine.
	Manual Setup	SSID	Input the SSID.
		Security	Disable

Item		Factory default settings	Description
	WEP Key		Input the WEP key.
	WPA Encryption Type		Displays the WPA-PSK encryption type. The setting is carried out automatically according to the security settings. (Impossible to switch in this menu)
	WPA Pre-shared Key		Input the pre-shared key. Displayed when [Security] is set to any other value than [Disable] or [WEP].
	Execute		Executes the changes to security settings.
Wireless reconnection			Reconnects to the wireless LAN (infrastructure).

Wireless(AP Mode) Setting

Item		Factory default settings	Description
Enter Password		*****	Input the password required to enter the Admin Setup menu.
Wireless(AP mode)		Disable	Enables/Disables wired (AP mode).
Automatic Setup (PushButton)			If YES is selected, automatic connection can be started with a push button. If the connection has failed, the system goes back to the home screen. If the connection is successful, [Wireless(AP Mode) connection setting is completed/Close by the setting button] is displayed.
Manual Setup			Displays the SSID and password of this machine for manual setup.
Connection Setting	SSID	OKI-Printer name-Last 6 digits of the MAC address	Inputs a new one to change the SSID.
	Password		Inputs a new one to change the password.
	IPv4 Address	192.168.110.100	Input the IPv4 address.
	Execute		Executes connection setup.
AP Mode User Setting		Don't disclose user	Sets whether or not to disclose the AP mode information to users other than the administrator.

Boot Menu

To display the Boot Menu, do the following.

1. Power on this machine while pressing «OK» on the operator panel. When [Boot Menu] appears on the display, release your finger and press «OK» again.
2. Input the admin password using the numeric keypad, and press «OK».

[Admin password](#)(P.195)

Item	Factory default settings	Description
Enter Password	*****	Input the password required to enter the Boot Menu.
Menu Lockout	Off	When [On] is set, the administrator setup menu and user menu list are hidden and thus unavailable. However, only printing settings are displayed.
Panel Lockout	Off	Disables buttons/keys on the operator panel. [Mode1]: Disables all keys except «ON LINE», «OK», «CANCEL», «POWER SAVE» and «HELP». [Mode2]: Disables keys except «ON LINE», «OK» and «POWER SAVE». [Off]: Do not restrict operations with buttons/keys on the operator panel.
After AC power supply fails	Always Off	Sets whether to restore the Ready To Print status automatically in case of a power failure. [Always On]: This machine is started by force when the power failure is recovered without pressing the power switch. This machine starts simply by connecting the power plug to the outlet. [Always Off]: This machine does not start when the power failure is recovered without pressing the power switch. [Last State]: This machine remembers the state when the power supply is interrupted and restarts with that state after the power failure is recovered. This machine automatically restores the Ready-to-Print state when the power failure is recovered even if the power supply is interrupted due to a power failure while the machine is working. If a power failure occurs when the power is off, this machine does not start even after the power failure is recovered.

5 Printing

Printing from a PC	131
Screens and functions of the printer driver	133
Printing on various types of paper.....	143
Printing methods	151
Printing in economy mode.....	162
Color setup	166
Refining your finishing	172
Useful functions.....	179
Canceling the printing	192

Printing from a PC

For Windows PCL printer driver

- 1 Open the file to be printed.
- 2 Select [Print] from the [File] menu.
- 3 Select [OKI C650 PCL6] from [Select Printer].
- 4 Click [Preferences] (or [Properties]).



- 5 Select the loaded paper size from [Size] in the [Setup] tab.

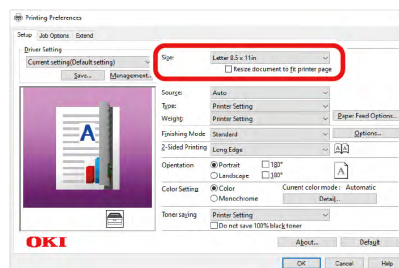

- 6 Select the tray to be printed from in [Source].
 - If you cannot select Tray 2/3/4, see "[Setting the printer driver\(P.64\)](#)".
- 7 Set [Type] and [Weight].
- 8 Set other necessary items.
- 9 Click [OK].
- 10 Printing starts.

For Windows PS printer driver

- 1 Open the file to be printed.
- 2 Select [Print] from the [File] menu.
- 3 Select [OKI C650 PS] from [Select Printer].
- 4 Click [Preferences] (or [Properties]).

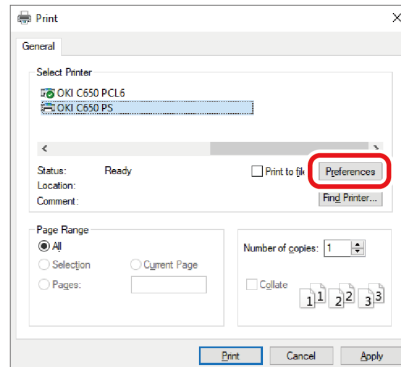

- 5 Select the [Paper/Quality] tab.
- 6 Select the tray to be printed from in [Paper Source].
 - If you cannot select Tray 2/3/4, see "[Setting the printer driver](#)(P.64)".
- 7 Click [Advanced].
- 8 Click [Paper Size], and select the loaded paper size from the drop-down list.
- 9 Set other necessary items.
- 10 Click [OK].
- 11 Printing starts.

For macOS

- 1 Open the file to be printed.
- 2 Select [Page Setup] from the [File] menu.
- 3 Select the loaded paper size from [Media Size], and click [OK].
- 4 Select [Print] from the [File] menu.
- 5 Select [Paper Feed] from the panel menu.
- 6 Select [All Pages From], and select the tray to be printed from.
 - If you cannot select Tray 2/3/4, see "[Setting the printer driver](#)(P.64)".
- 7 Set other necessary items.
- 8 Printing starts.

Screens and functions of the printer driver

Windows PCL printer driver

[Setup] tab

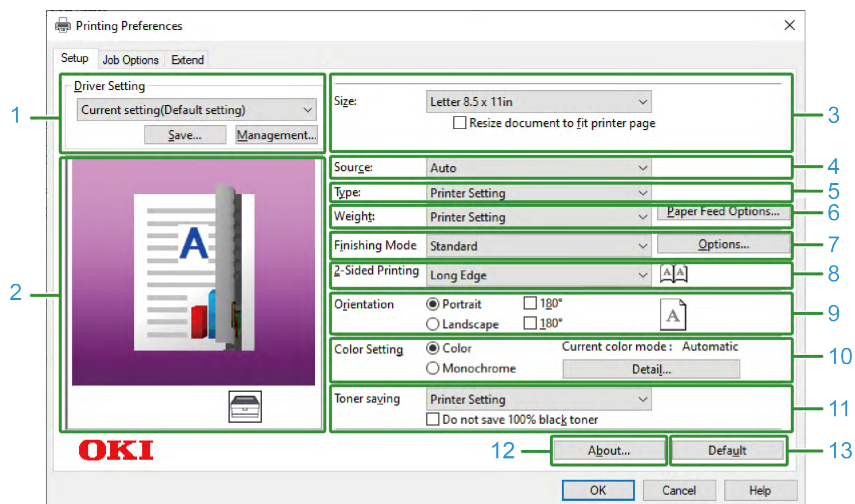

No.	Item	Description
1	Driver settings	Save the settings.
2	Layout image	Displays a sample image of the print layout.
3	Size	Sets the media size.
4	Source	Sets the paper source.
5	Type	Sets the media type.
6	Weight	Sets the media weight.
7	Finishing Mode	Sets multicast printing, booklet printing, poster printing, etc.
8	2-Sided Printing	Sets the duplex printing.
9	Orientation	Sets the printing orientation.
10	Color Setting	Switches between color printing and mono printing.
11	Toner saving	Decreases the print density to reduce the amount of toner to be used.
12	About	Displays the version of the printer driver.
13	Default	Restores the settings of each item in the tab to the initial values.

[Job Options] tab

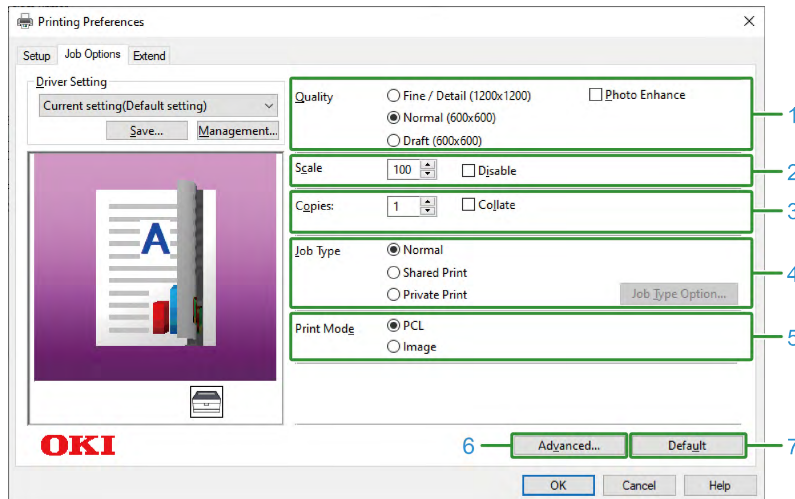

No.	Item	Description
1	Quality	Specifies the print resolution.
2	Scale	Sets the enlargement/reduction of printing.
3	Copies	Specifies the number of copies.
4	Job type	Sets the type of printing.
5	Print mode	Sets whether the print data sent to the printer is in PCL format or as an image.
6	Advanced	Make other printing settings.
7	Default	Restores the settings of each item in the tab to the initial values.

[Extend] tab

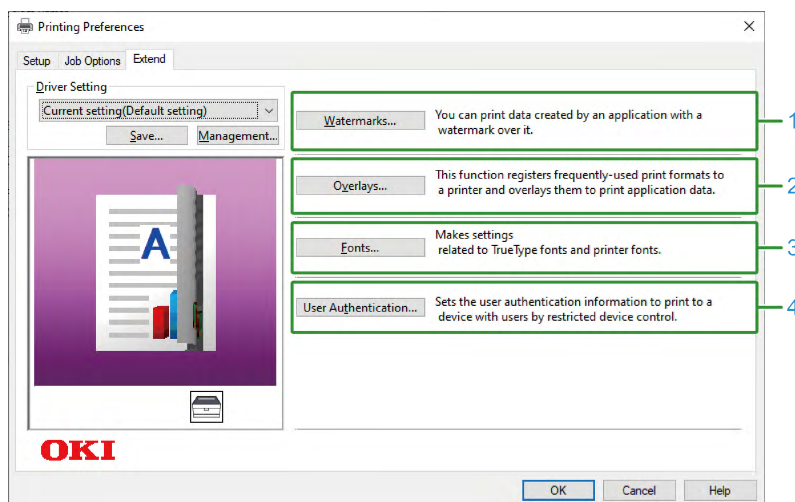

No.	Item	Description
1	Watermarks	Set for printing with a text or stamp watermark.
2	Overlays	Set for printing with an overlapping print format registered in the printer beforehand.
3	Fonts	Sets the TrueType font and printer font.
4	User authentication	Sets the user authentication.

Windows PS printer driver

[Layout] tab

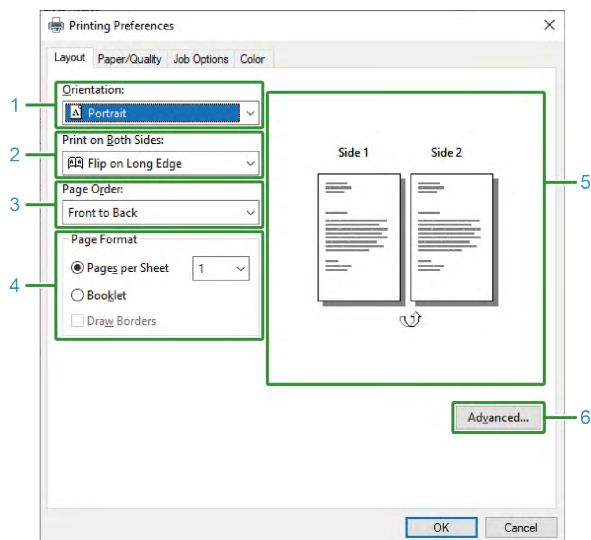

No.	Item	Description
1	Orientation	Sets the printing orientation.
2	Print on Both Sides	Set for duplex printing.
3	Page order	Sets the order of pages to be printed.
4	Page format	Specifies the number of pages to be printed on one sheet of paper and booklet printing.
5	Layout image	Displays a sample image of the print layout.
6	Advanced	You can make detail settings such as the print quality and media size.

[Paper/Quality] tab

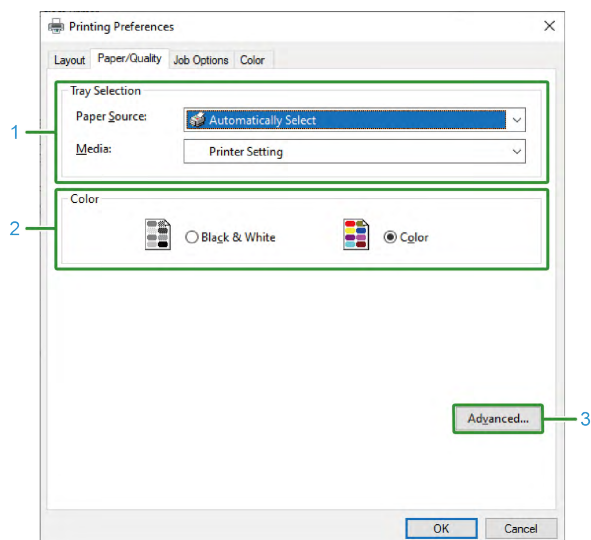

No.	Item	Description
1	Tray selection	Changes the paper tray.
2	Color	Selects to print in color/mono mode.
3	Advanced	You can make detail settings such as the print quality and media size.

[Job Options] tab

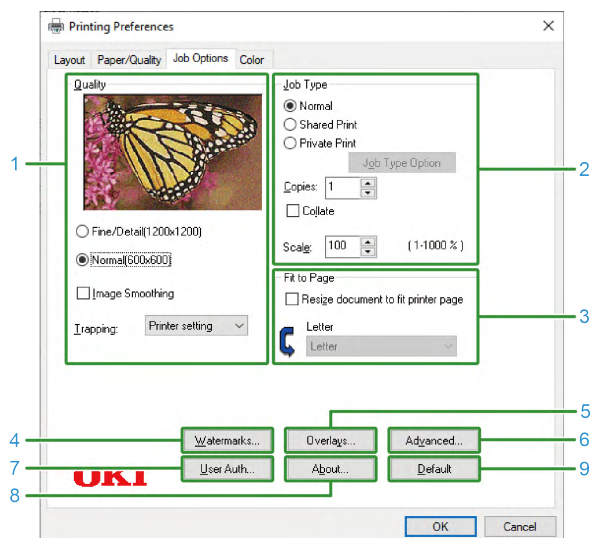

No.	Item	Description
1	Quality	Specifies the print resolution.
2	Job Type	Sets the type of print data and the number of copies. When [Shared Print] or [Private Print] is set, [Job Type Options] is available. If [Collate] is checked, multiple documents will be printed as a batch.
3	Fit to page	Check [Resize document to fit printer page] to print on a different size of paper.
4	Watermarks	Set for printing with a text or stamp watermark.
5	Overlays	Set for printing with an overlapping format registered in the printer beforehand.
6	Advanced	Other settings can be made.
7	User authentication	Sets the user authentication.
8	About	Displays the version of the printer driver.
9	Default	Restores the settings of each item in the tab to the initial values.

[Color] tab

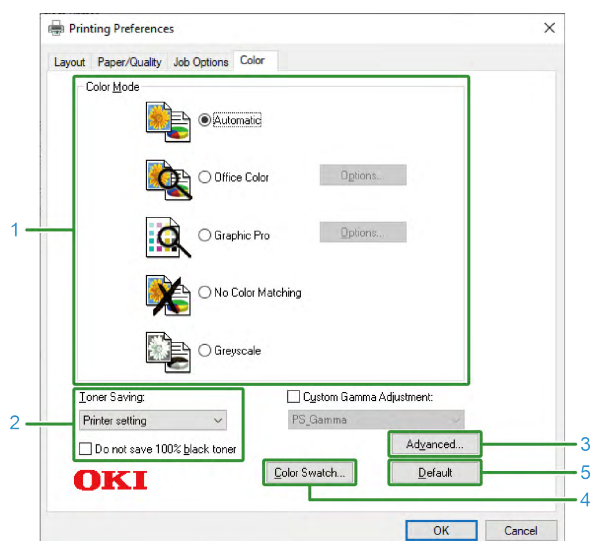

No.	Item	Description
1	Color Mode	Specifies the color adjustment for colored printing.
2	Toner Saving	Print in the toner save mode.
3	Advanced	Other printing settings can be made.
4	Color Swatch Utility	Starts the Color Swatch Utility.
5	Default	Restores the settings of each item in the tab to the initial values.

macOS printer driver

[Layout] panel

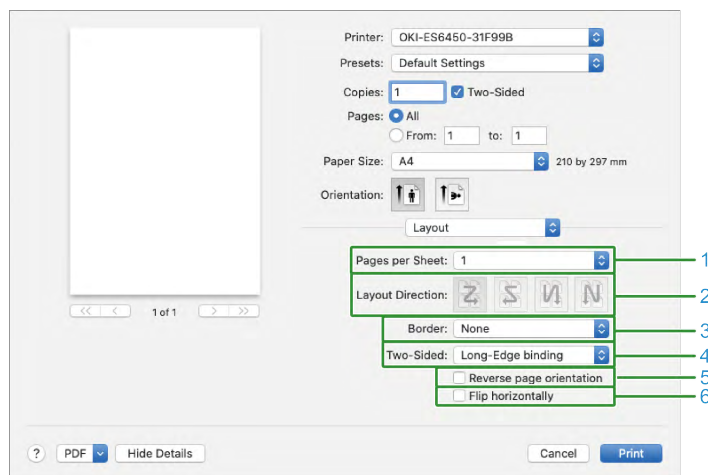

No.	Item	Description
1	Pages per Sheet	Selects the number of pages to be printed on one sheet of paper.
2	Layout direction	Specifies the layout for printing multiple pages on one sheet of paper.
3	Border	Specifies the type of borders.
4	Two-Sided	Specifies settings for printing on both sides.
5	Reverse page orientation	Checked to print with the page direction reversed.
6	Flip horizontally	Checked to print with the left and right reversed.

[Color Matching] panel

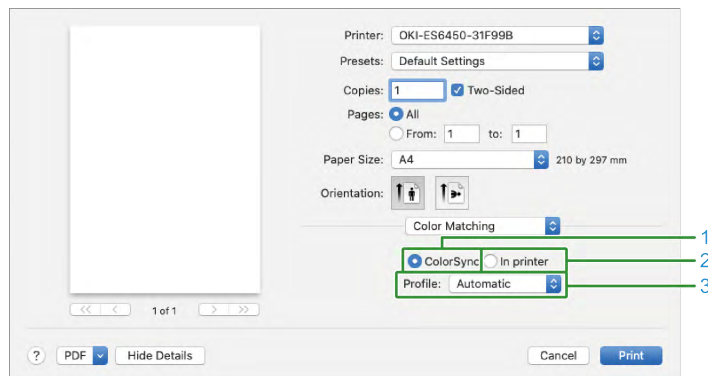

No.	Item	Description
1	ColorSync	Specifies the ColorSync function.
2	In printer	Uses color matching in this machine.
3	Profile	Specifies a profile.

[Paper Handling] panel

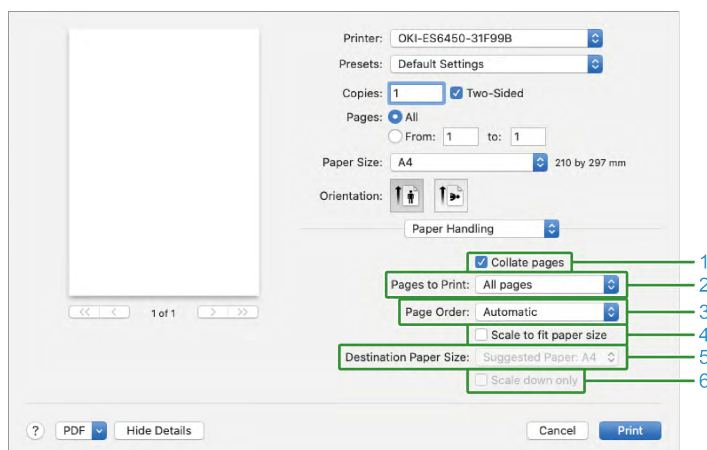

No.	Item	Description
1	Collate pages	Checked to print a multi-page document in collation.
2	Pages to print	Specifies the pages to be printed.
3	Page Order	Specifies the order of pages to be printed.
4	Scale to fit paper size	Prints by fitting to the media size. Depending on the settings, printing may not work correctly. Checked to print by zooming-in/-out according to the media size.
5	Destination Paper Size	Specifies the size of the paper to be printed when [Scale to fit paper size] is checked.
6	Scale down only	Specifies settings for printing in reduction only to fit the size of the paper.

[Paper Feed] panel

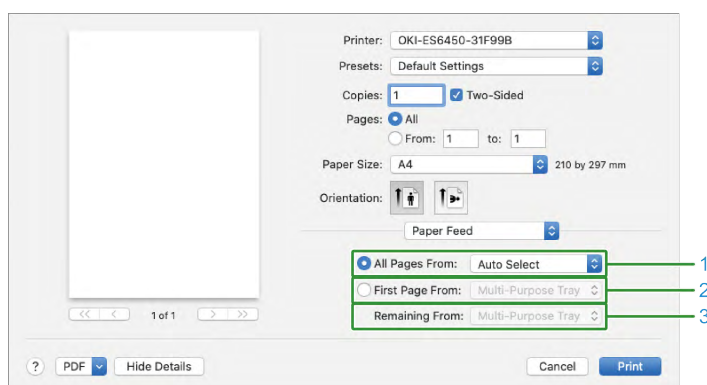

No.	Item	Description
1	All Pages From	Specifies the tray to feed paper. When [Auto Select] is specified, a tray is selected automatically.
2	First Page From	Selected to print only the first page from the specified tray.
3	Remaining From	Selected to print the remaining pages from the specified tray.

[Cover Page] panel

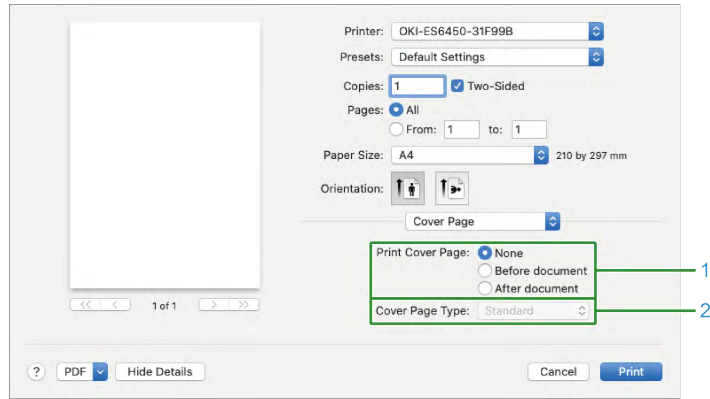

No.	Item	Description
1	Print Cover Page	Specifies the cover printing.
2	Cover Page Type	Specifies the text string for cover printing.

[Color] panel

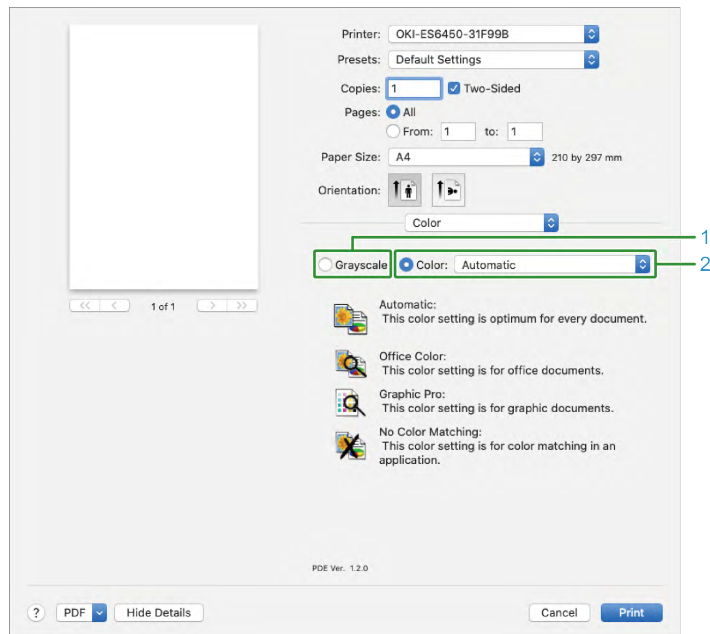

No.	Item	Description
1	Grayscale	Print in monochrome.
2	Color	Specifies the color adjustment for colored printing.

[Print Options] panel

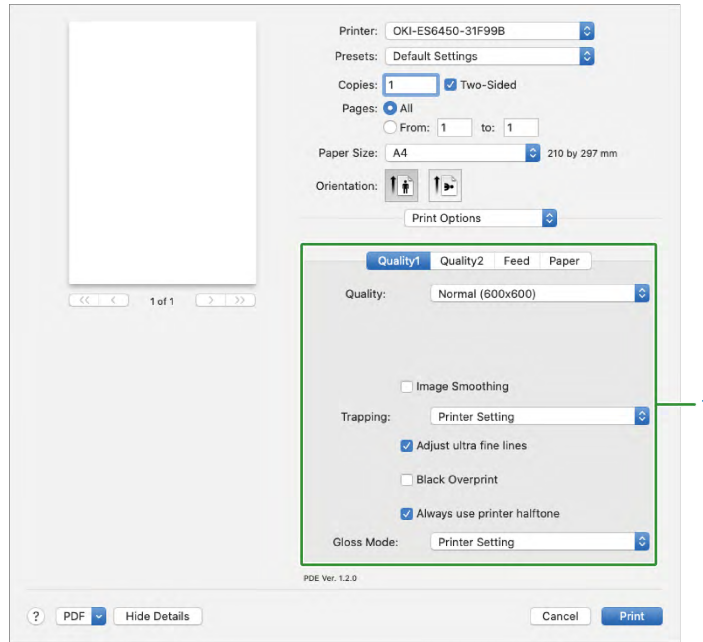

No.	Item	Description
1	Quality1, Quality2, Feed, Paper	Specifies the print quality, toner save, media type, etc.

[User Authentication] panel

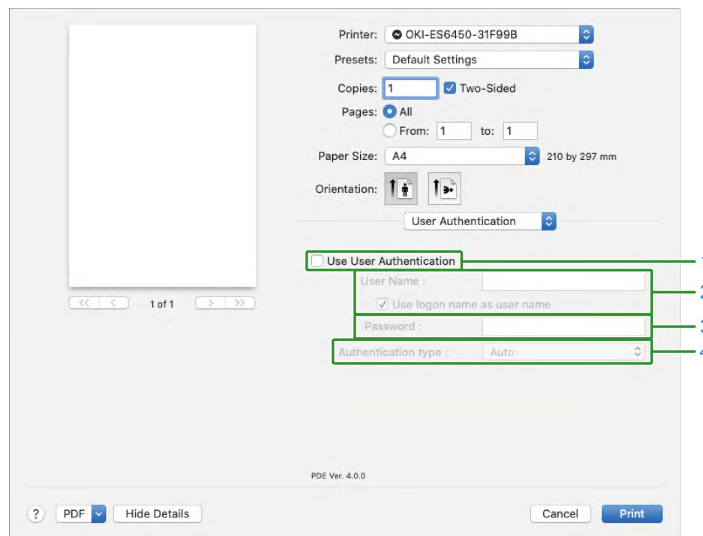

No.	Item	Description
1	Use user authentication	Checked to set user authentication for printing.
2	User name	The user name for user authentication.
3	Password	The password for user authentication.
4	Authentication type	Specifies the authentication type to be used.



- [Authentication Type] can be enabled in the [Options] tab of [Options and Supplies] displayed by selecting [System Preferences] - [Printers and Scanners] from the Apple menu.

[Secure Print] panel

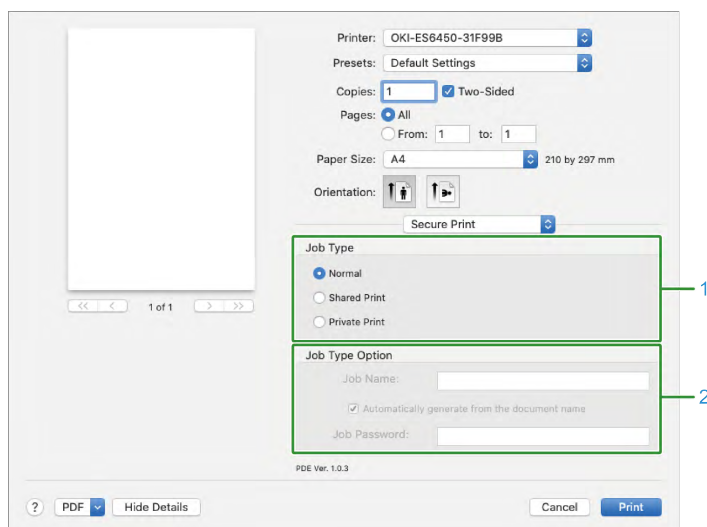

No.	Item	Description
1	Job Type	Specifies the type of print data. When [Private Print] or [Shared Print] is set, [Job Type Options] is available.
2	Job Type Options	Specifies the password for printing the job name displayed on the panel.

[Supply Level] panel

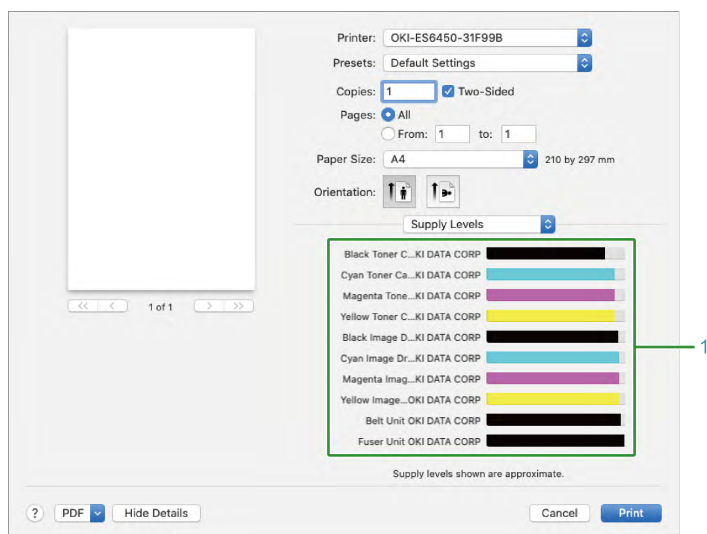

No.	Item	Description
1	Consumables	Displays the usage status of consumables.



- The [Supply Level] panel may not be displayed depending on the usage environment such as the connection method of this machine.

How to open the printer folder

This section explains how to open the printer driver icon folder for each version of Windows.

For Windows 10 (Version 1703 or later)/Windows Server 2019

- 1 Click [Start] to display the application list.
- 2 Select [Windows System Tool] - [Control Panel] - [Devices and Printers].

For Windows Server 2012 R2/Windows Server 2016

- 1 Select [Control Panel] - [View devices and printers].

For Windows 10/Windows 8/Windows 8.1/Windows Server 2012

- 1 Open the control panel and select [View devices and printers].

For Windows 7/Windows Server 2008 R2

- 1 Select [Start] - [Devices and Printers].

Printing on various types of paper

This section describes how to print on various types of paper.

Printing on envelopes

To print on envelopes, change the setting of the media size, and use the MP tray and the rear output tray. First, set the media size for the MP tray on the operator panel. Then, set the media size, paper tray, media weight, etc. in the printer driver.

Loading envelopes

1 Check the paper precautions.

- [Applicable paper](#)(P.72)
- [Inapplicable paper](#)(P.74)
- [Paper precautions by type](#)(P.74)

2 Load the envelope in the MP tray.

With the address side facing up, place each envelope in the following orientation.

- Load the envelopes (Com-9, Com-10, DL, C5, Monarch) with the flaps (opening margin) open as shown in the figure.
- The arrow indicates the direction to feed the paper.

Com-9, Com-10, DL, C5, Monarch



3 Open the rear output tray on the back.



- If you always print on envelopes from the MP tray, register the loaded media in this machine. If you print on envelopes only once, go to the printing procedure from the printer driver.

4 Check that "Ready To Print" appears on the display.



- If the machine is in the power save mode, press «POWER SAVE» to restore.

5 Press «Fn» on the operator panel.

6 On the functional number screen, press «9», «0» and «OK».

7 Press the scroll button ▼ to select [Envelope*], and press «OK».

* Select the type of the envelope loaded.

8 Press «ON LINE» to return to the standby screen.

Printing from a PC

For Windows PCL printer driver

1 Open the file to be printed.

2 Select [Print] from the [File] menu.

- 3 Click [Preferences].
- 4 Select [Envelope*] from [Size] in the [Setup] tab.
* Select the type of the envelope loaded.
- 5 Select [Multi Purpose Tray] in [Source].
- 6 Select [Portrait] or [Landscape] in [Orientation].
- 7 Specify the media weight and other settings as necessary, and click [OK].



- If you want to print while checking each sheet, click [Paper Feed Options] in [Setup] of the printer driver and check [Feed paper individually] (or select [Yes]). To print continuously, uncheck [Feed paper individually] (or select [No]). For details, see "[Printing one sheet at a time manually](#)(P.151)".

- 8 Click [Print] in the [Print] screen.

For Windows PS printer driver

- 1 Open the file to be printed.
- 2 Select [Print] from the [File] menu.
- 3 Click [Preferences].
- 4 Click [Advanced] in the [Layout] tab, and select [Envelope*] from [Paper Size].
* Select the type of the envelope loaded.
- 5 Click [OK].
- 6 Select [Portrait] or [Landscape] from [Orientation] in the [Layout] tab.
- 7 Select [Multi Purpose Tray] from [Paper Source] in the [Paper/Quality] tab.
- 8 Specify the media weight and other settings as necessary, and click [OK].



- If you want to print while checking each sheet, check [Feeds paper one by one from the MP tray] in [Advanced] on the [Layout] tab of the printer driver (or select [Yes]). To print continuously, uncheck [Feeds paper one by one from the MP tray] (or select [No]). For details, see "[Printing one sheet at a time manually](#)(P.151)".

- 9 Click [Print] in the [Print] screen.

For macOS

- 1 Open the file to be printed.
- 2 Select [Print] from the [File] menu.
- 3 Select the envelope size in [Paper Size] and the orientation in [Orientation]
- 4 Select [MP Tray] from [All Pages From] in the [Paper Feed] panel.
- 5 Specify the media weight and other settings as necessary, and click [Print].



- If you want to print while checking each sheet, check [Feeds paper one by one from the MP tray] (or select [Yes]) in the printer driver . To print continuously, uncheck [Feeds paper one by one from the MP tray] (or select [No]). For details, see "[Printing one sheet at a time manually](#)(P.151)".
- If there is no detail settings displayed in the [Print] screen, click [Show details] at the bottom of the screen.

Printing on labels

To print on labels, change the setting of media type, and use the multi-purpose tray (MP tray) and the rear output tray.

First, set the media size and media type for the MP tray on the operator panel. Next, set the media size, paper tray, media weight, etc. in the printer driver.

Loading labels

- 1 Check the paper precautions.

- [Applicable paper\(P.72\)](#)
- [Inapplicable paper\(P.74\)](#)
- [Paper precautions by type\(P.74\)](#)

- 2 With the print side facing up, load labels in the MP tray.

Label

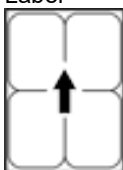

The arrow indicates the direction to feed the media.

- 3 Open the rear output tray on the back.



- If you always print on labels from the MP tray, register the loaded media in this machine. If you print on labels only once, go to the printing procedure from the printer driver.

- 4 Check that "Ready To Print" appears on the display.



- If the machine is in the power save mode, press «POWER SAVE» to restore.

- 5 Press «Fn» on the operator panel.

- 6 When the numerical input screen is displayed, press «9», «0» and «OK».

- 7 Press the scroll button ▼ to select [A4] or [Letter], and press «OK».

- 8 Press «BACK» and confirm that the [MPTray Config] screen is displayed.

- 9 Press ▼ to select [Media Type], and press «OK».

- 10 Press ▼ to select [Labels], and press «OK».

- 11 Press «ON LINE» to return to the standby screen.

Printing from a PC

For Windows PCL printer driver

- 1 Open the file to be printed.
- 2 Select [Print] from the [File] menu.
- 3 Click [Preferences].
- 4 Select [A4] or [Letter] from [Size] in the [Setup] tab.
- 5 Select [Multi Purpose Tray] in [Source].
- 6 Specify [Portrait] in [Orientation].

7 Specify the media weight and other settings as necessary, and click [OK].



- If you want to print while checking each sheet, check [Feed paper individually] in the printer driver (or select [Yes]). To print continuously, uncheck [Feed paper individually] (or select [No]). For details, see "[Printing one sheet at a time manually](#)(P.151)".

8 Click [Print] in the [Print] screen.

For Windows PS printer driver

1 Open the file to be printed.

2 Select [Print] from the [File] menu.

3 Click [Preferences].

4 Click [Advanced] in the [Layout] tab, and select [A4] or [Letter] from [Paper Size].

5 Click [OK].

6 Select [Multi Purpose Tray] from [Paper Source] in the [Paper/Quality] tab.

7 Specify [Portrait] from [Orientation] in the [Layout] tab.

8 Specify the media weight and other settings as necessary, and click [OK].



- If you want to print while checking each sheet, check [Feeds paper one by one from the MP tray] in the printer driver (or select [Yes]). To print continuously, uncheck [Feeds paper one by one from the MP tray] (or select [No]). For details, see "[Printing one sheet at a time manually](#)(P.151)".

9 Click [Print] in the [Print] screen.

For macOS

1 Open the file to be printed.

2 Select [Print] from the [File] menu.

3 Select [A4] or [Letter] in [Paper Size] and the orientation in [Orientation].

4 Select [Multi-Purpose Tray] from [All Pages From] in the [Paper Feed] panel.

5 Specify [Portrait] in [Orientation].

6 Specify the media weight and other settings as necessary, and click [Print].



- If you want to print while checking each sheet, check [Feeds paper one by one from the MP tray] in the printer driver (or select [Yes]). To print continuously, uncheck [Feeds paper one by one from the MP tray] (or select [No]). For details, see "[Printing one sheet at a time manually](#)(P.151)".
- If there is no detail settings displayed in the [Print] screen, click [Show Details] at the bottom of the screen.

Printing on long paper

To print on long paper, change the setting of media type, and use the multi-purpose tray (MP tray) and the rear output tray.

First, set the media size for the MP tray on the operator panel. Next, register the media size and media weight in the printer driver.

The media size that can be registered ranges from 55 mm to 216 mm in width and from 91 mm to 1,321 mm in length.

Loading paper

- 1 Check the paper precautions.
 - [Applicable paper](#)(P.72)
 - [Inapplicable paper](#)(P.74)
 - [Paper precautions by type](#)(P.74)
- 2 Load paper in the MP tray.
- 3 Open the rear output tray on the back.
- 4 Check that "Ready To Print" appears on the display.
 - 
 - If the machine is in the power save mode, press «POWER SAVE» to restore.
- 5 Press «Fn» on the operator panel.
- 6 When the numerical input screen is displayed, press «9», «0» and «OK».
- 7 Press the scroll button ▼ several times to select [Cassette Size], and press «OK».
- 8 Press «BACK».
- 9 Press ▼ to select [X Dimension], and press «OK».
- 10 Input the X dimension using the numeric keypad, and press «OK».
- 11 Press «BACK».
- 12 Press ▼ to select [Y Dimension], and press «OK».
- 13 Input the Y dimension using the numeric keypad, and press «OK».
- 14 Press «ON LINE» to return to the standby screen.



[Applicable paper](#)(P.72)

Printing from a PC

For Windows PCL printer driver

- 1 Open the file to be printed.
- 2 Select [Print] from the [File] menu.
- 3 Click [Preferences].
- 4 Select [Set User Defined Size] from [Size] in the [Setup] tab.
 - 
 - If the set media size is 210.0 x 900.0 mm, 215.0 x 900.0 mm, or 215.0 x 1200.0 mm, you can select the media size from [Banner *** x *** mm].
 - For how to set the irregular size, see "[Printing on irregular-sized paper \(custom size\)](#)(P.148)".
- 5 Select [Multi Purpose Tray] in [Source].
- 6 Specify the media weight and other settings as necessary, and click [OK].
- 7 Click [Print] in the [Print] screen.

For Windows PS printer driver

- 1 Open the "Devices and Printers".
 - [How to open the printer folder](#)(P.142)

- 2 Right-click on the icon [OKI C650 PS], and select [Printing preferences].
- 3 Click [Advanced] in the [Layout] tab.
- 4 Click [Paper Size], select [PostScript Custom Page Size] from the pull-down menu, and input values in [Width] and [Height].
- 5 Click [OK] until the [Print settings] screen is closed.
- 6 Open the file to be printed.
- 7 Select [Print] from the [File] menu.
- 8 Click [Preferences].
- 9 Click [Advanced] in the [Layout] tab, and select [PostScript Custom Page Size] from [Paper Size], and then click [OK].
- 10 Click [OK].
- 11 Select [Paper/Quality] from [Paper Source] in the [Multi Purpose Tray] tab.
- 12 Specify the media weight and other settings as necessary, and click [OK].
- 13 Click [Print] in the [Print] screen.

For macOS

- 1 Open the file to be printed.
- 2 Select [Print] from the [File] menu.
- 3 Select [Manage Custom Size] in [Paper Size].
- 4 Click [+] to add an item to the list of media size.
- 5 Double-click on [Untitled], and input a name for the long media size.
- 6 Input values in [Width] and [Height].
- 7 Click [OK].
- 8 Select the media size registered in [Paper Size].
- 9 Select [Multi-Purpose Tray] from [All Page From] in the [Paper Size] panel.
- 10 Specify the media weight and other settings as necessary, and click [Print].



- If there is no detail settings displayed in the [Print] screen, click [Show Details] at the bottom of the screen.

Printing on irregular-sized paper (custom size)

When printing on irregular-sized paper (custom size), set the media size, media type and media weight of the irregular size (custom size) on the operator panel. Next, register the media size in the printer driver.

Setting the media size after loading the paper

- 1 Check the paper precautions.
 - [Applicable paper](#)(P.72)
 - [Inapplicable paper](#)(P.74)
 - [Paper precautions by type](#)(P.74)



- 2 Load the paper with a size that can be set to a custom size into the tray to be used.
- 3 Check that "Ready To Print" appears on the display.

 - If the machine is in the power save mode, press «POWER SAVE» to restore.
- 4 Press the scroll button ▼ on the operator panel several times to select [Menus], and press «OK».
- 5 Check that [Tray Configuration] is selected, and press «OK».
- 6 Press ▼ several times to select [Tray Setup] of the tray where the paper is loaded, and press «OK».
- 7 Check that [Media Size] is selected, and press «OK».
- 8 Press ▼ several times to select [Custom], and press «OK».
- 9 Press «BACK».
- 10 Press ▼ to select [X Dimension], and press «OK».
- 11 Input the X dimension using the numeric keypad, and press «OK».
- 12 Press «BACK».
- 13 Press ▼ to select [Y Dimension], and press «OK».
- 14 Input the Y dimension using the numeric keypad, and press «OK».
- 15 Press «ON LINE» to return to the standby screen.

Printing from a PC



For Windows PCL printer driver

- 1 Open the "Devices and Printers".
 [How to open the printer folder](#)(P.142)
- 2 Right-click on the icon [OKI C650 PCL6], and select [Printing preferences].
- 3 Click [Paper Feed Options] in the [Setup] tab.
- 4 Click [Custom Size].
- 5 Input a name for the new size in [Name].
- 6 Input values in [Width] and [Length].
- 7 Click [Add] to save any media size in the list, and click [OK].
Up to 32 settings can be saved.
- 8 Click [OK] until the [Printing preferences] screen is closed.
- 9 Open the file to be printed.
- 10 Select [Print] from the [File] menu.
- 11 Click [Preferences].
- 12 Select the media size registered in [Size] on the [Setup] tab.
- 13 Specify the media weight and other settings as necessary, and click [OK].
- 14 Click [Print] in the [Print] screen.

For Windows PS printer driver

- 1 Open the "Devices and Printers".
 [How to open the printer folder\(P.142\)](#)
- 2 Right-click on the icon [OKI C650 PS], and select [Printing preferences].
- 3 Click [Advanced] in the [Layout] tab.
- 4 Click [Paper Size], and select [PostScript Custom Page Size] from the pull-down menu.
- 5 Click [PostScript Custom Page Size Definition].
- 6 Input values in [Width] and [Height], and click [OK].

 - [Offset Relative to Paper Feed Direction] cannot be set.
- 7 Click [OK] until the [Printing preferences] screen is closed.
- 8 Open the file to be printed.
- 9 Select [Print] from the [File] menu.
- 10 Click [Preferences].
- 11 Click [Advanced] in the [Layout] tab.
- 12 Select [PostScript Custom Page Size] from [Paper Size].
- 13 Click [OK].
- 14 Specify the media weight and other settings as necessary, and click [OK].
- 15 Click [Print] in the [Print] screen.

For macOS

- 
- When using macOS, you cannot print properly, although you can set the media size beyond the usable range. Set the media size within the range.
 - macOS may regard the custom-sized paper which is close to a fixed size as the fixed-sized paper.
- 1 Open the file to be printed.
 - 2 Select [Page Setup] from the [File] menu.
 - 3 Select [Manage Custom Size] from [Paper Size].
 - 4 Click [+] to add an item to the list of media size.
 - 5 Double-click on [Untitled], and input a name for the media size.
 - 6 Input values in [Width] and [Height].
 - 7 Click [OK] until the [Page Setup] is closed.
 - 8 Select [Print] from the [File] menu.
 - 9 Select the media size registered in [Paper Size].
 - 10 Specify the media weight and other settings as necessary, and click [Print].

 - If there is no detail settings displayed in the [Print] screen, click [Show Details] at the bottom of the screen.

Printing methods

This section describes various printing methods such as zooming-in/-out and booklet printing.

Printing one sheet at a time manually

You can print one sheet at a time by loading paper to the MP tray.

Each time after a single page is printed, the display shows the message "Manual Printing. Set [Media Size] In MP Tray. Press OK To Start Printing". To continue printing, press «OK».

To cancel the printing, press «CANCEL».

For Windows PCL printer driver

- 1 Open the file to be printed.
- 2 Select [Print] from the [File] menu.
- 3 Click [Preferences].
- 4 Select [Multi Purpose Tray] from [Source] in the [Setup] tab.
- 5 Click [Paper Feed Options].
- 6 Check [Feed paper individually] in [Multi Purpose Tray], and click [OK].
- 7 Specify other settings as necessary, and click [OK].
- 8 Click [Print] in the [Print] screen.
- 9 If a message appears on the display, load paper into the MP tray and press «ON LINE».

If you are printing a multi-page document, the same message appears each time after one page is printed.

For Windows PS printer driver

- 1 Open the file to be printed.
- 2 Select [Print] from the [File] menu.
- 3 Click [Preferences].
- 4 Select [Multi Purpose Tray] from [Paper Source] in the [Paper/Quality] tab.
- 5 Click [Advanced].
- 6 Select [Yes] from [Feeds paper one by one from the MP tray] in [Printer Features].
- 7 Click [OK].
- 8 Specify other settings as necessary, and click [OK].
- 9 Click [Print] in the [Print] screen.
- 10 If a message appears on the display, load paper into the MP tray and press «ON LINE».

If you are printing a multi-page document, the same message appears each time after one page is printed.

For macOS

- 1 Open the file to be printed.
- 2 Select [Print] from the [File] menu.
- 3 Select [Multi-Purpose Tray] from [All Pages From] in the [Paper Feed] panel.

- 4 Select the [Print Options] panel.
 - 5 Check [Feed paper individually] in the [Paper Feed] tab.
 - 6 Specify other settings as necessary, and click [Print].
 - 7 If a message appears on the display, load paper into the MP tray and press «ON LINE».
- If you are printing a multi-page document, the same message appears each time after one page is printed.



- If there is no detail settings displayed in the [Print] screen, click [Show details] at the bottom of the screen.

Enlarging/Reducing to fit the specified media size

You can print on a different media size without changing the print data.



- This function is not applicable to some applications.

For Windows PCL printer driver

- 1 Open the file to be printed.
- 2 Select [Print] from the [File] menu.
- 3 Click [Preferences].
- 4 Select the media size of the print data in [Size] in the [Setup] tab.
- 5 Check [Resize document to fit printer page] in [Size].
- 6 Select the size of the media to be printed on.
- 7 Specify other settings as necessary, and click [OK].
- 8 Click [Print] in the [Print] screen.

For Windows PS printer driver

- 1 Open the file to be printed.
- 2 Select [Print] from the [File] menu.
- 3 Click [Preferences].
- 4 Check [Resize document to fit printer page] in the [Job Options] tab.
- 5 Select the size of the media to be printed on.
- 6 Specify other settings as necessary, and click [OK].
- 7 Click [Print] in the [Print] screen.

For macOS

- 1 Open the file to be printed.
- 2 Select [Print] from the [File] menu.
- 3 Check [Scale to fit paper size] in the [Paper Handling] panel.
- 4 Select the size of the media to be printed on in [Destination Paper Size].

- 5 Specify other settings as necessary, and click [Print].



- If there is no detail settings displayed in the [Print] screen, click [Show Details] at the bottom of the screen.

Printing by enlargement/reduction

You can print at the magnification rate you want without changing the print data.



- This function is not available to macOS.
- This function is not applicable to some applications.

For Windows PCL printer driver

- 1 Open the file to be printed.
- 2 Select [Print] from the [File] menu.
- 3 Click [Preferences].
- 4 Input the scaling rate for [Scale] on the [Job Options] tab.
- 5 Specify other settings as necessary, and click [OK].
- 6 Click [Print] in the [Print] screen.

For Windows PS printer driver

- 1 Open the file to be printed.
- 2 Select [Print] from the [File] menu.
- 3 Click [Preferences].
- 4 Input the scaling rate for [Scale] of [Job Type] inn the [Print Options] tab.
- 5 Specify other settings as necessary, and click [OK].
- 6 Click [Print] in the [Print] screen.

Printing only the cover from another tray

You can choose to feed the first page and the remaining pages from different trays.



- This function is not available to the Windows PS printer driver.

For Windows PCL printer driver

- 1 Open the file to be printed.
- 2 Select [Print] from the [File] menu.
- 3 Click [Preferences].
- 4 Click [Paper Feed Options] in the [Setup] tab.
- 5 Check [Use different source for first page].

- 6 Select the paper tray from [Source], and click [OK].
Select the paper type from [Type], and the paper weight from [Weight] as necessary.
- 7 Specify other settings as necessary, and click [OK].
- 8 Click [Print] in the [Print] screen.

For macOS

- 1 Open the file to be printed.
- 2 Select [Print] from the [File] menu.
- 3 Select the [Paper Feed] panel.
- 4 Select [First Page From], and select the tray to feed the first page.
- 5 Select the tray to feed the remaining pages in [Remaining From].
- 6 Specify other settings as necessary, and click [Print].



- If there is no detail settings displayed in the [Print] screen, click [Show Details] at the bottom of the screen.

Booklet printing



- Some applications may not be available.
- This function is not available to macOS.
- Watermarks cannot be printed correctly when [Booklet] is used.
- This function is disabled when private jobs are printed from a client PC that shares the network of the device with the print server.

For Windows PCL printer driver

- 1 Open the file to be printed.
- 2 Select [Print] from the [File] menu.
- 3 Click [Preferences].
- 4 Select [Booklet] in [Finishing Mode] on the [Setup] tab.
- 5 Click [Options], and set booklet printing as necessary.
 - [Signature]: Specifies the unit of the page to close.
 - [2 pages]: Prints 2 pages on 1 sheet of paper.
 - [Right to Left]: Prints to create a right-to-left booklet.
 - [Bind Margin]: Sets the margin.
- 6 Click [OK].
- 7 Specify other settings as necessary, and click [OK].
- 8 Click [Print] in the [Print] screen.



- To create an A5 booklet using A4-sized paper, select [A4] from [Size] in the [Setup] tab.

- If [Booklet] is not available to the Windows PCL printer driver, open the "Devices and Printers", right-click on the icon [OKI C650 PCL6], and select [Printer Properties] - [Preferences] tab - [Print Processor] - [OKX05PPP] - [RAW], and click [OK].
To open the "Devices and Printers", see "[How to open the printer folder\(P.142\)](#)".

For Windows PS printer driver

- 1 Open the file to be printed.
- 2 Select [Print] from the [File] menu.
- 3 Click [Preferences].
- 4 Select [Booklet] in [Page Format] in the [Layout] tab.
- 5 Check [Draw Borders] as necessary.
- 6 Click [Advanced].
- 7 Click [Booklet Binding Edge] under [Document Options] to set the binding position.



- To make a right-edge binding booklet (i.e. a booklet with the binding on the right edge when the first page is facing up), select [On Right Edge].
- To create an A5-sized booklet using A4 paper, select [A4] from [Paper Size].

- 8 Click [OK] until the [Printing preferences] screen is closed.
- 9 Specify other settings as necessary, and click [OK].
- 10 Click [Print] in the [Print] screen.



- If [Page Format] is not displayed in the [Layout] tab, open the "Devices and Printers", right-click on the [OKI C650 PS] icon, and select [Printer properties] - [Advances] tab. Check [Enable advanced printing features].
To open the "Devices and Printers", see "[How to open the printer folder\(P.142\)](#)".

Printing a poster by dividing a document

A single document can be divided or enlarged for printing on multiple pages. Finally, you will create a poster by combining all pages together.



- This function is not available to an IPP network.
- This function is not available to the Windows PS printer driver or macOS.

For Windows PCL printer driver

- 1 Open the file to be printed.
- 2 Select [Print] from the [File] menu.
- 3 Click [Preferences].
- 4 Select [Poster Print] from [Finishing Mode] of the [Setup] tab.
- 5 Click [Options].
- 6 Set the values of [Hor./Vert. Enlargement], [Add Registration Marks] and [Add Overlap] as necessary, and click [OK].
- 7 Specify other settings as necessary, and click [OK].

8 Click [Print] in the [Print] screen.



- To create an A2-sized poster using 4 sheets of A4 paper, select [A4] in the paper size, and select [4] in [Enlarge].
- If this feature is not available to the Windows PCL printer driver, open the "Devices and Printers", right-click on the icon [OKI C650 PCL6], and select [Printer properties] - [Advanced] tab - [Print Processor] - [OKX05NPP] - [RAW], and click [OK].

Inserting and printing a watermark text (watermark)



- This function is not available to macOS.
- Watermarks cannot be printed correctly in booklet printing.
- If you check [Print in background] on the [Watermarks] screen of the Windows PS printer driver, the watermark may not be printed depending on the application. In this case, uncheck [Print in background].

For Windows PCL printer driver

- 1 Open the file to be printed.
- 2 Select [Print] from the [File] menu.
- 3 Click [Preferences].
- 4 Click [Watermarks] on the [Extend] tab.



- To print the job information such as a user name for printing or a document name as a watermark, check [Print job information] and set the job information to be printed.

- 5 Click [New].
- 6 Input the text string to be printed as a stamp in [Text] of the [Watermarks] screen.
- 7 Set [Font], [Size], etc. as necessary, and click [OK].
- 8 Make sure that the watermark to be printed is selected, and click [OK].
- 9 Specify other settings as necessary, and click [OK].
- 10 Click [Print] in the [Print] screen.

For Windows PS printer driver

- 1 Open the file to be printed.
- 2 Select [Print] from the [File] menu.
- 3 Click [Preferences].
- 4 Click [Watermark] of the [Job Options] tab.
- 5 Click [New].
- 6 Input the text string to be printed as a stamp in [Text] of the [Watermark] screen.
- 7 Set [Font], [Size], etc. as necessary, and click [OK].
- 8 Make sure that the watermark to be printed is selected, and click [OK].
- 9 Specify other settings as necessary, and click [OK].
- 10 Click [Print] in the [Print] screen.

Printing overlaid text or logos (overlay printing)

You can print a document with an overlapping form file (like a logo or format) registered in this machine beforehand. It is called overlay printing.



- This function is not available to macOS.
- It is not available to the Windows PCL printer driver when [Print Mode] is set to [Image].

Registering a form file

For Windows PCL printer driver

- 1 From the application, create a form which you want to register with this machine.
- 2 Select [Print] from the [File] menu.
- 3 Click [Preferences].
- 4 Click [Overlays] in the [Extend] tab.
- 5 Select [Register print document as a new form].
- 6 Click [OK].
- 7 Specify other settings as necessary, and click [OK].
- 8 Click [Print] in the [Print] screen.
- 9 From [New Form], input [Form name] and [ID] to register with this machine.
 -  You can also specify the print position of an overlay.
- 10 Select the page onto which you want to apply that overlay in [Print on Pages] as the registration information to the printer driver.
To specify a page to apply to, select "Custom", and input the target page in [Custom Pages].
- 11 Click [OK].

For Windows PS printer driver

Refer to "[Registering forms \(form overlay\)](#)(P.271)" for the detailed procedure.

Printing a form file

For Windows PCL printer driver

- 1 Open the file to be printed.
- 2 Select [Print] from the [File] menu.
- 3 Click [Preferences].
- 4 Select the [Extend] tab.
- 5 Click [Overlays].

6 Select [Overlay Print], and then select the form file to overlay from the drop-down list.



- Click [Edit list] and add it to the list if you want to add a form file registered with the Configuration Tool or if you want to overlay multiple forms as a group.

If you want to add a form file registered with the Configuration Tool, click [Add a registered form], input the form name in [Form name] and the ID of the form registered with the Storage Manager plugin of the Configuration Tool in [ID], select the page onto which you want to apply that overlay in [Print on Pages], and click [OK].

7 Click [OK].

8 Specify other settings as necessary, and click [OK].

9 Click [Print] in the [Print] screen.

For Windows PS printer driver



- You will have to log into the PC as a user with administrator privileges.

1 Open the "Devices and Printers".

2 Right-click on the PS printer icon, and select [Printing Preferences].

3 Click [Overlays] of the [Job Options] tab.

4 Select [Use Overlays] from the pull-down menu, and click [New].

5 Input the form name registered with the Storage Manager plug-in of the Configuration Tool in [Form Name], and click [Add].

6 In [Overlay Name], input an overlay name.

7 Select the page onto which you want to apply that overlay in [Print on Pages].

8 Click [OK].

9 Select the overlay to be used for printing from [Defined Overlays], and click [Add].

10 Click [OK].

11 Specify other settings as necessary, and click [OK].

12 Open the file to be printed.

13 Select [Print] from the [File] menu.

14 Click [Print] in the [Print] screen.

Outputting to a file without printing on paper

You can export print data to a file and save it without printing on paper.



- To perform this procedure, you will have to login to the PC as a user with administrator privileges.

For Windows

1 Open the "Devices and Printers".

[How to open the printer folder](#)(P.142)

2 Right-click on the icon [OKI C650 *], and select [Printer properties].

* Please select the type of printer driver that you want to use.

- 3 Select the [Ports] tab.
- 4 Select [FILE:] from the port list, and click [OK].
- 5 Open the file to be printed.
- 6 Select [Print] from the [File] menu.
- 7 Click [Print].
- 8 Input the file name, and click [OK].
Example: C:\temp\printdata.prn

For macOS

- 1 Open the file to be printed.
- 2 Select [Print] from the [File] menu.
- 3 Click [PDF] on the print screen, and select the file format to be saved as.
- 4 Input a name for the file, select a destination for the file, and then click [Save].

Printing frequently used documents without using a PC

By storing frequently used documents in the machine, you can print them directly from the operator panel without using a PC.



- If the print data cannot be stored due to insufficient capacity of the memory, a message is displayed indicating that the file system is full and the printing will not be performed.

Storing documents

For Windows PCL printer driver

- 1 Open the file to be printed.
- 2 Select [Print] from the [File] menu.
- 3 Click [Preferences].
- 4 Select the [Job Options] tab.
- 5 Select [Shared Print] from [Job Type].
- 6 Click [Job Type Option].
- 7 Input the print data name in [Job Name].
If you check [Input job type option when printing], a prompt asking for the print data name is displayed when the print data is sent to this machine.
- 8 Click [OK].
- 9 Make other settings as necessary to print.
The print data is sent to this machine, but not printed yet.

For Windows PS printer driver

- 1 Open the file to be printed.

- 2 Select [Print] from the [File] menu.
- 3 Click [Preferences].
- 4 Select the [Job Options] tab.
- 5 Select [Shared Print] from [Job Type].
- 6 Click [Job Type Option].
- 7 Input the print data name in [Job Name].
If you check [Input job type option when printing], a prompt asking for the print data name is displayed when the print data is sent to this machine.
- 8 Click [OK].
- 9 Make other settings as necessary to print.
The print data is sent to this machine, but not printed yet.

For macOS

- 1 Open the file to be printed.
- 2 Select [Print] from the [File] menu.
- 3 Select the [Secure Print] panel.
- 4 Select [Shared Print] from [Job Type].
- 5 Specify other settings as necessary, and click [Print].
The print data is sent to this machine, but not printed yet.



- If there is no detail settings displayed in the [Print] screen, click [Show Details] at the bottom of the screen.

Printing the saved document

- 1 Check that "Ready To Print" appears on the display.

 - If the machine is in the power save mode, press «POWER SAVE» to restore.
- 2 Press «Fn» on the operator panel.
- 3 On the functional number screen, press «1» and «OK».
- 4 If a list of shared print data appears, press the scroll button ▲ or ▼ to select the shared print data which you want to print, and press «OK».
 - To print all shared print data, select [Print All] and press «OK».
 - Select [Delete All] and press «OK» to delete all the shared print data displayed.
- 5 Check that [Print] has been selected, and press «OK».

Select [Delete] and press «OK» to delete the print data.
- 6 Input the number of copies, and press «OK».

Printing an email attachment

This machine can print the file attached to the email you have received. Printable file formats are PDF (v1.7), JPEG and TIFF (V6 baseline).

To use this function, you will have to configure email reception settings on the POP server or SMTP server.

 [Setting E-mail receiving \(Web page\)](#)(P.216)



- The email body will not be printed.
- For the number of copies, duplex printing or other settings, the current settings of [Admin Setup] will be applied.
- Up to 10 files with a maximum size of 8 MB per file can be printed.

Printing in economy mode

This section describes how to save paper and toner on printing.

Printing on both sides of paper

You can print on both sides of paper.

For paper applicable to duplex printing, see "[Applicable paper](#)(P.72)".



- Some applications may not be available.

For Windows PCL printer driver

- 1 Open the file to be printed.
- 2 Select [Print] from the [File] menu.
- 3 Click [Preferences].
- 4 Select [Long Edge] or [Short Edge] from [2-Sided Printing] on the [Setup] tab.
- 5 Specify other settings as necessary, and click [OK].
- 6 Click [Print] in the [Print] screen.

For Windows PS printer driver

- 1 Open the file to be printed.
- 2 Select [Print] from the [File] menu.
- 3 Click [Preferences].
- 4 Select [Flip on Long Edge] or [Flip on Short Edge] from [Print on Both Sides] in the [Layout] tab.
- 5 Specify other settings as necessary, and click [OK].
- 6 Click [Print] in the [Print] screen.

For macOS

- 1 Open the file to be printed.
- 2 Select [Print] from the [File] menu.
- 3 Select [Long-Edge blinding] or [Short-Edge blinding] from [Two-Sided] in the [Layout] panel.
- 4 Specify other settings as necessary, and click [Print].



- If there is no detail settings displayed in the [Print] screen, click [Show Details] at the bottom of the screen.

Printing in the toner save mode

Print in the toner save mode.

The amount of toner to be saved can be set in 3 levels.

- [Printer Setting]: Follows the device settings.
- [OFF]: Prints at normal density without saving toner.

- [Save Level Low]: Prints at a slightly lighter density.
- [Save Level Middle]: Prints at a light density.
- [Save Level High]: Prints at a considerably light density.



- The density of the image printed using this function varies with the print data.
- If you do not want to reduce the printing density for 100% black, check [Do not save 100% black toner].
- The amount of toner to be saved can also be set from the operator panel of this machine. Set the amount of toner to be saved in [Admin Setup] - [Print Setup] - [Toner Save] - [Toner Save Level]. However, the setting of the printer driver takes priority.
- The default setting of the printer driver is [Printer Setting].

For Windows PCL printer driver

- 1 Open the file to be printed.
- 2 Select [Print] from the [File] menu.
- 3 Click [Preferences].
- 4 Select the [Setup] tab.
- 5 Select the amount of toner to be saved from [Toner saving].
- 6 Specify other settings as necessary, and click [OK].
- 7 Click [Print] in the [Print] screen.

For Windows PS printer driver

- 1 Open the file to be printed.
- 2 Select [Print] from the [File] menu.
- 3 Click [Preferences].
- 4 Select the [Color] tab.
- 5 Select the amount of toner to be saved from [Toner saving].
- 6 Specify other settings as necessary, and click [OK].
- 7 Click [Print] in the [Print] screen.

For macOS

- 1 Open the file to be printed.
- 2 Select [Print] from the [File] menu.
- 3 Select the [Print Options] panel.
- 4 Select the amount of toner to be saved in [Toner Saving] of the [Quality2] tab.
- 5 Specify other settings as necessary, and click [Print].



- If there is no detail settings displayed in the [Print] screen, click [Show Details] at the bottom of the screen.

N-in-1 printing

You can print by zooming in on the data of multiple pages to one side of a single sheet of paper.



- This function prints data at a reduced size, so the center of the paper may not be aligned accurately.
- Some applications may not be available.

For Windows PCL printer driver

- 1 Open the file to be printed.
- 2 Select [Print] from the [File] menu.
- 3 Click [Preferences].
- 4 Select the number of pages to be printed on 1 sheet in [Finishing Mode] of the [Setup] tab.
- 5 Click [Options].
- 6 Set [Page Borders], [Page Layout] and [Bind Margin], and then click [OK].
- 7 Specify other settings as necessary, and click [OK].
- 8 Click [Print] in the [Print] screen.

For Windows PS printer driver

- 1 Open the file to be printed.
- 2 Select [Print] from the [File] menu.
- 3 Click [Preferences].
- 4 Select [Pages per sheet] in the [Page Format] of the [Layout] tab.
- 5 Select the number of pages to be printed on 1 sheet from the pull-down menu.
- 6 If you want to draw a borderline, check [Draw Borders].
- 7 Click [Advanced], select the order of page layout from the [Pages per sheet layout] in the [Document Options].
- 8 Click [OK].
- 9 Specify other settings as necessary, and click [OK].
- 10 Click [Print] in the [Print] screen.

For macOS

- 1 Open the file to be printed.
- 2 Select [Print] from the [File] menu.
- 3 Select the number of pages to be printed on 1 sheet in [Pages per Sheet] of the [Layout] panel.
- 4 Set the [Border] and [Layout Direction].
- 5 Specify other settings as necessary, and click [Print].



- If there is no detail settings displayed in the [Print] screen, click [Show Details] at the bottom of the screen.

Printing as an image (image)

If it takes a long time to print, you can select [Image] in [Print Mode] to shorten the printing time.

This function is available to the Windows PCL printer driver only.



- This function has the following limitations.
 - When this machine is set as a shared printer, or when connected via a WSD / IPP port and in environments such as a remote desktop client, it will not print with the optimal color.
 - Overlay printing, printing with printer fonts, or trapping function cannot be used.
 - If you select a setting that cannot be used when [Print Mode] is set to [Image] for functions other than the above, a warning for resolving the conflict will be displayed.
 - A warning will be displayed if this machine is not connected or if it is offline due to an error.
 - The results of color tone or representation will be different when printing with [PCL] of [Print Mode].

- 1 Open the file to be printed.
- 2 Select [Print] from the [File] menu.
- 3 Click [Preferences].
- 4 Select the [Job Options] tab.
- 5 Select [Image] in [Print Mode].
- 6 Specify other settings as necessary, and click [OK].
- 7 Click [Print] in the [Print] screen.

Color setup

Printing color data in monochrome

You can print color data in monochrome.

For Windows PCL printer driver

- 1 Open the file to be printed.
- 2 Select [Print] from the [File] menu.
- 3 Click [Preferences].
- 4 Select [Monochrome] in [Color Setting] of the [Setup] tab.
- 5 Specify other settings as necessary, and click [OK].
- 6 Click [Print] in the [Print] screen.



- You can print color data in monochrome by selecting [Monochrome] even when cyan, magenta and yellow toners are empty.

For Windows PS printer driver

- 1 Open the file to be printed.
- 2 Select [Print] from the [File] menu.
- 3 Click [Preferences].
- 4 Select [Greyscale] in [Color Mode] of [Color] tab.
- 5 Specify other settings as necessary, and click [OK].
- 6 Click [Print] in the [Print] screen.



- You can print color data in monochrome by selecting [Greyscale] even when cyan, magenta and yellow toners are empty.

For macOS

- 1 Open the file to be printed.
- 2 Select [Print] from the [File] menu.
- 3 Select the [Color] panel.
- 4 Select [Grayscale].
- 5 Specify other settings as necessary, and click [Print].



- You can print color data in monochrome by selecting [Grayscale] even when cyan, magenta and yellow toners are empty.
- If there is no detail settings displayed in the [Print] screen, click [Show details] at the bottom of the screen.

Color matching in the printer driver

Color matching is to manage and adjust colors of print data to maintain the consistency between input and output devices.

This section explains color matching in the printer driver.

Settings	Description
Automatic	Color matching shall be done depending on the specific document. In general, use this setting.
Office Color	Select it if you print a business document by using the word processing software, spreadsheet software, and presentation software. The print data of RGB color space is color matched for CMYK color space of this machine.
Graphic Pro	Select it if you use the software for DTP. You can specify a simulation when printing by a CMYK output device.
No Color Matching	Select it if you match the color from an application.

For macOS, you can also use the [ColorSync] function for color matching.



- To manage CMYK color data, use the Graphics Pro function.
- The CMYK Link Profile cannot be specified with the Windows PCL printer driver.

For Windows PCL printer driver

- 1 Open the file to be printed.
- 2 Select [Print] from the [File] menu.
- 3 Click [Preferences].
- 4 Select [Color] in [Color Setting] of the [Setup] tab.
- 5 Click [Detail].
- 6 Select the item you want to set, and click [OK].
- 7 Specify other settings as necessary, and click [OK].
- 8 Click [Print] in the [Print] screen.

For Windows PS printer driver

- 1 Open the file to be printed.
- 2 Select [Print] from the [File] menu.
- 3 Click [Preferences].
- 4 Select the [Color] tab.
- 5 Select the item you want to set, and click [OK].
- 6 Specify other settings as necessary, and click [OK].
- 7 Click [Print] in the [Print] screen.

For macOS

- 1 Open the file to be printed.
- 2 Select [Print] from the [File] menu.
- 3 Select the [Color] panel.
- 4 Select the item you want to set in [Color].

5 Specify other settings as necessary, and click [Print].



- If there is no detail settings displayed in the [Print] screen, click [Show Details] at the bottom of the screen.

Simulating print results

By adjusting CMYK color data, this machine will simulate the characteristics of the ink used for offset printing.



- Some applications may not be available for macOS.
- This function can be used when [Graphic Pro] is selected in [Color Mode].

For Windows PCL printer driver

- 1 Open the file to be printed.
- 2 Select [Print] from the [File] menu.
- 3 Click [Preferences].
- 4 Select [Color] in [Color Setting] of the [Setup] tab.
- 5 Click [Options] in [Setup], and select [Graphic Pro].
- 6 Select [Printer Simulation].
- 7 Select the characteristics of the ink that you want to simulate from [Simulation Target Profile] of [Input Profile], and click [OK].
- 8 Specify other settings as necessary, and click [OK].
- 9 Click [Print] in the [Print] screen.

For Windows PS printer driver

- 1 Open the file to be printed.
- 2 Select [Print] from the [File] menu.
- 3 Click [Preferences].
- 4 Select the [Color] tab, select [Graphic Pro], and then click [Options].
You can also simulate business documents by using [Office Color]. Click [Options], and select the attribute of the ink that you want to simulate from [CMYK Ink Simulation].
- 5 Select [Printer Simulation].
- 6 Select the characteristics of the ink that you want to simulate from [Simulation Target Profile] of [Input], and click [OK].
- 7 Specify other settings as necessary, and click [OK].
- 8 Click [Print] in the [Print] screen.

For macOS

- 1 Open the file to be printed.
- 2 Select [Print] from the [File] menu.
- 3 Select the [Color] panel.

- 4 Select [Graphic Pro] in [Color].
- 5 Select [Printing Simulation] in [Mode Selection].
- 6 Select the characteristics of the ink that you want to simulate in [Simulation Target Profile] of [Input] tab.
- 7 Specify other settings as necessary, and click [Print].



- If there is no detail settings displayed on the [Print] screen, click [Show Details] at the bottom of the screen.

Printing with color separation

The color separation printing function can be used without any application.



- This function is not available to the Windows PCL printer driver.
- If you are using the Adobe Illustrator, use the color separation function of this application. In this case, disable the color matching function in the printer driver.

For Windows PS printer driver

- 1 Open the file to be printed.
- 2 Select [Print] from the [File] menu.
- 3 Click [Preferences].
- 4 Select the [Color] tab, and click [Advanced].
- 5 Select the color that you want to print in separation from [Print color separations], and click [OK].
- 6 Specify other settings as necessary, and click [OK].
- 7 Click [Print] in the [Print] screen.

For macOS

- 1 Open the file to be printed.
- 2 Select [Print] from the [File] menu.
- 3 Select the [Print Options] panel
- 4 Select the color that you want to print in separation from [Separations] of the [Quality2] tab.
- 5 Specify other settings as necessary, and click [Print].



- If there is no detail settings displayed in the [Print] screen, click [Show Details] at the bottom of the screen.

Adjusting registration manually

Although this machine adjusts registration automatically when the power is turned on or when the output tray is opened and closed, it is possible to adjust it manually in case the registration is concerned.

- 1 Check that "Ready To Print" appears on the display.



- If the machine is in the power save mode, press «POWER SAVE» to restore.

- 2 Press «Fn» on the operator panel.
- 3 On the function number screen, press «3», «0», «1» and finally «OK».
- 4 Check that [Execute] is selected, and press «OK».



- During registration adjustment, "Color Adjusting" is displayed on the second line (under "Ready To Print") of the display.

Adjusting the density manually

The machine automatically adjusts the density every time when about 500 sheets have been printed after a new image drum is installed or when continuous printing is done. If you are concerned about the print density, you can adjust it manually from the operator panel.

- 1 Check that "Ready To Print" appears on the display.



- If the machine is in the power save mode, press «POWER SAVE» to restore.

- 2 Press «Fn» on the operator panel.



- If this machine is in the power save mode, press the «POWER SAVE» to wake it up from the power save mode.

- 3 On the function number screen, press «3», «0», «0» and finally «OK».

- 4 Check that [Execute] is selected, and press «OK».



- During density adjustment, "Density Adjusting" is displayed on the second line (under "Ready To Print") of the display.

Adjusting the color balance (density)

Print the color tuning pattern to check the color, and adjust the color as you like from the operator panel. Specify the adjustment by darkening or lightening the three areas of highlight, mid-tone and dark of each color.

- 1 Check that "Ready To Print" appears on the display.



- If the machine is in the power save mode, press «POWER SAVE» to restore.

- 2 Press «Fn» on the operator panel.

- 3 On the function number screen, press «3», «0», «2» and finally «OK».

- 4 Check that [Execute] is selected, and press «OK».

A color sample is printed.



- The color tuning pattern is printed as 44 quadrilaterals. The current settings of highlight, dark, and mid-tone of colors are displayed as dotted lines. Check the colors for adjustment.

- 5 Press the scroll button ▼ several times to select [Calibration], and press «OK».

- 6 Press ▼ several times to select [Cyan Tuning], [Magenta Tuning], [Yellow Tuning] or [Black Tuning], and press «OK».

- 7 Press ▼ to select [Highlight], [Dark] or [Mid-Tone], and press «OK».
- 8 Press ▲ or ▼ to select the value (-3 to +3), and press «OK».
- 9 Press «ON LINE» to return to the standby screen.
- 10 Printing starts.
Repeat until you get the desired color.

Changing mono print mode

You can adjust the print mode of mono pages. The available values are as follows.

Settings	Description
[Auto]	Controls the print mode with a good balance. Please select "Auto" generally.
[Color Mode]	Suitable for printing a large amount of color pages. Always print by using 4 color image drums without switching between color pages and monochrome pages.
[Normal Mode]	Suitable for printing a large amount of mono pages. Color pages are printed by using 4 color image drums, and mono pages are printed by using the black image drum only. If color pages and mono pages are mixed, the printing time will be longer.



- The admin password is required to enter the [Admin Setup] menu.

- 1 Check that "Ready To Print" appears on the display.



- If the machine is in the power save mode, press «POWER SAVE» to restore.

- 2 Press the scroll button ▼ on the operator panel several times to select [Admin Setup], and press «OK».
- 3 Input the admin password using the numeric keypad, and press «OK».
[Admin password](#)(P.195)
- 4 Press ▼ several times to select [Print Setup], and press «OK».
- 5 Press ▼ to select [Mono-Print Mode], and press «OK».
- 6 Select the print mode, and press «OK».
- 7 Press «ON LINE» to return to the standby screen.

Adjustment with utilities

You can tune the color using utility software. Please refer to the instructions on the specific utility for details.

[Color Correct Utility](#)(P.259)

[Color Swatch Utility](#)(P.257)

Refining your finishing

This section describes how to make the print result better when you are printing from your PC.

Printing sharper photos

You can print more naturally vividly images like photos.



- This function is not available to the Windows PS printer driver or macOS.

For Windows PCL printer driver

- 1 Open the file to be printed.
- 2 Select [Print] from the [File] menu.
- 3 Click [Preferences].
- 4 Select the [Job Options] tab
- 5 Check [Photo Enhance].
- 6 Specify other settings as necessary, and click [OK].
- 7 Click [Print] in the [Print] screen.

Printing with the specified print resolution

You can change the print quality as needed.

For Windows PCL printer driver

- 1 Open the file to be printed.
- 2 Select [Print] from the [File] menu.
- 3 Click [Preferences].
- 4 Select the [Job Options] tab.
- 5 Select the value you want to set from [Quality].
- 6 Specify other settings as necessary, and click [OK].
- 7 Click [Print] in the [Print] screen.

For Windows PS printer driver

- 1 Open the file to be printed.
- 2 Select [Print] from the [File] menu.
- 3 Click [Preferences].
- 4 Select the [Job Options] tab.
- 5 Select the value you want to set from [Quality].
- 6 Specify other settings as necessary, and click [OK].
- 7 Click [Print] in the [Print] screen.

For macOS

- 1 Open the file to be printed.
- 2 Select [Print] from the [File] menu.
- 3 Select the [Print Options] panel.
- 4 Select the value you want to set from [Quality] of the [Quality1] tab.
- 5 Specify other settings as necessary, and click [Print].



- If there is no detail settings displayed in the [Print] screen, click [Show details] at the bottom of the screen.

Printing by correcting fine lines

The fine line correcting function is enabled by default to prevent fine lines from becoming faint or inconsistent in thickness.

Depending on the specific application, the spacing of bar codes may become narrower. In that case, disable the function.

For Windows PCL printer driver

When this function is enabled, ultra fine lines are slightly thicker.

- 1 Open the file to be printed.
- 2 Select [Print] from the [File] menu.
- 3 Click [Preferences].
- 4 Select the [Job Options] tab.
- 5 Click [Advanced].
- 6 Select [Adjust ultra fine lines] in [Item], set it to [ON] in [Settings], and click [OK].
- 7 Specify other settings as necessary, and click [OK].
- 8 Click [Print] in the [Print] screen.

For Windows PS printer driver

When this function is enabled, the thickness of ultra fine lines is consistent in the specified direction.

When this function is disabled, ultra fine lines may be slightly thicker.

- 1 Open the file to be printed.
- 2 Select [Print] from the [File] menu.
- 3 Click [Preferences].
- 4 Select the [Job Options] tab.
- 5 Click [Advanced].
- 6 Check [Adjust ultra fine lines], and click [OK].
- 7 Specify other settings as necessary, and click [OK].
- 8 Click [Print] in the [Print] screen.

For macOS

- 1 Open the file to be printed.
- 2 Select [Print] from the [File] menu.
- 3 Select the [Print Options] panel.
- 4 Check [Adjust ultra fine lines] in the [Quality1] tab.
- 5 Specify other settings as necessary, and click [Print].



- If there is no detail settings displayed in the [Print] screen, click [Show details] at the bottom of the screen.

Printing by specifying the font to use

Using printer-specific fonts

- The printer fonts may not be reproduced as the TrueType font design displayed on screen.
- This function is not available to the Windows PCL printer driver when [Print Mode] is set as [Image], nor to a macOS.
- This function is not applicable to some applications.

For Windows PCL printer driver

- 1 Open the file to be printed.
- 2 Select [Print] from the [File] menu.
- 3 Click [Preferences].
- 4 Select the [Extend] tab.
- 5 Click [Font].
- 6 Check [Font Substitution] in [TrueType Font Output Type].
- 7 Specify the printer font to be used instead of the TrueType font in [Font Substitution Table].
- 8 Click [OK].
- 9 Specify other settings as necessary, and click [OK].
- 10 Click [Print] in the [Print] screen.

For Windows PS printer driver

- 1 Open the "Devices and Printer".
[🔗 How to open the printer folder\(P.142\)](#)
- 2 Right-click on the icon of [OKI C650 PS], and select [Printer Properties].
- 3 Double-click on [Font Substitution Table] in the [Device settings] tab.
- 4 Click the TrueType font, and select the substitution printer font from the list.
- 5 Click [OK].
- 6 Open the file to be printed.
- 7 Select [Print] from the [File] menu.
- 8 Click [Preferences].

- 9 Click [Advanced] in the [Layout] tab.
- 10 Select [Substitute with Device Font] from [TrueType Font] in [Graphic].
- 11 Click [OK].
- 12 Specify other settings as necessary, and click [OK].
- 13 Click [Print] in the [Print] screen.

Using PC fonts

With the TrueType font of the PC, you can print with the same text as the screen display.



- This function is not applicable to macOS.

For Windows PCL printer driver

- 1 Open the file to be printed.
- 2 Select [Print] from the [File] menu.
- 3 Click [Preferences].
- 4 Click [Extend] tab.
- 5 Click [Font].
- 6 Uncheck [Font Substitution] in [TrueType Font Output Type], select the export format, and click [OK].
 - [Download as Outline Font]
Creates font images using the printer.
 - [Download as Bitmap Font]
Creates font images using the printer driver.
- 7 Specify other settings as necessary, and click [OK].
- 8 Click [Print] in the [Print] screen.

For Windows PS printer driver

- 1 Open the file to be printed.
- 2 Select [Print] from the [File] menu.
- 3 Click [Preferences].
- 4 Click [Advanced] in the [Layout] tab.
- 5 Select [Download as Softfont] from [TrueType Font] in [Graphic].
- 6 Click [OK].
- 7 Specify other settings as necessary, and click [OK].
- 8 Click [Print] in the [Print] screen.

Changing black finishing

The finishing for the black parts can be changed in color printing. The black finishing settings can be used when [Office Color] or [Graphic Pro] is selected in the printer driver.

Two types of black finishing can be created: from the toner cartridges of Cyan (C), Magenta (M), Yellow (Y) and Black (K), and from only Black (K). The black finishing with CMYK toner is ideal for printing photos. The black finishing with black toner is ideal for printing black characters and graphics.

This setting can be automatically selected when [Office Color] is selected. When Auto is selected, this machine prints by selecting the ideal method automatically.

For Windows PCL printer driver

- 1 Open the file to be printed
- 2 Select [Print] from the [File] menu.
- 3 Click [Preferences].
- 4 Select [Color] in [Color Setting] of the [Setup] tab.
- 5 Click [Detail] in [Setup], and select [Office Color] or [Graphic Pro].
- 6 Select the black finishing method from [Black Finish], and click [OK].
- 7 Specify other settings as necessary, and click [OK].
- 8 Click [Print] in the [Print] screen.

For Windows PS printer driver

- 1 Open the file to be printed.
- 2 Select [Print] from the [File] menu.
- 3 Click [Preferences].
- 4 Select the [Color] tab, then select [Office Color] or [Graphic Pro], and then click [Detail].
- 5 Select the black finishing method from [Black Finish], and click [OK].
- 6 Specify other settings as necessary, and click [OK].
- 7 Click [Print] in the [Print] screen.

For macOS

- 1 Open the file to be printed
- 2 Select [Print] from the [File] menu.
- 3 Select the [Color] panel.
- 4 Select [Office Color] or [Graphic Pro].
- 5 Select the black finishing method from [Black Finish].
- 6 Specify other settings as necessary, and click [Print].



- If there is no detail settings displayed on the [Print] screen, click [Show details] at the bottom of the screen.

Blurring white streaks between text and background (black overprint)

If there are white streaks and other gaps between black text and colored backgrounds, you can eliminate them by printing black text over colored backgrounds.



- This function is not applicable to some applications.
- This function is applicable when black text is printed over colored backgrounds.
- If the toner layer is too thick, the toner may not be fixed securely.

For Windows PCL printer driver

- 1 Open the file to be printed.
- 2 Select [Print] from the [File] menu.
- 3 Click [Preferences].
- 4 Select the [Job Options] tab and click [Advanced].
- 5 Change the setting of [Overprint Black] to [ON], and click [OK].
- 6 Specify other settings as necessary, and click [OK].
- 7 Click [Print] in the [Print] screen.

For Windows PS printer driver

- 1 Open the file to be printed.
- 2 Select [Print] from the [File] menu.
- 3 Click [Preferences].
- 4 Select the [Color] tab, and click [Advanced].
- 5 Check [Black overprint], and click [OK].
- 6 Specify other settings as necessary, and click [OK].
- 7 Click [Print] in the [Print] screen.

For macOS

- 1 Open the file to be printed.
- 2 Select [Print] from the [File] menu.
- 3 Select the [Print Options] panel.
- 4 Check [Black Overprint] in the [Quality1] tab.
- 5 Specify other settings as necessary, and click [Print].



- If there is no detail settings displayed in the [Print] screen, click [Show details] at the bottom of the screen.

Inconspicuous white streaks in color superposition (trapping function)

If white or colored streaks appear between overlapping objects, you can use the trapping function to make them less noticeable.



- This function is not available to the Windows PCL printer driver when [Print Mode] is set to [Image].

For Windows PCL printer driver

- 1 Open the file to be printed.
- 2 Select [Print] from the [File] menu.
- 3 Click [Preferences].
- 4 Select the [Job Options] tab and click [Advanced].
- 5 Change the setting of [Trapping] to [Narrow] or [Wide] according to the corrected amount, and click [OK].
- 6 Specify other settings as necessary, and click [OK].
- 7 Click [Print] in the [Print] screen.

For Windows PS printer driver

- 1 Open the file to be printed.
- 2 Select [Print] from the [File] menu.
- 3 Click [Preferences].
- 4 Select the [Job Options] tab.
- 5 Change the setting of [Trapping] to [Narrow] or [Wide] according to the corrected amount.
- 6 Specify other settings as necessary, and click [OK].
- 7 Click [Print] in the [Print] screen.

For macOS

- 1 Open the file to be printed.
- 2 Select [Print] from the [File] menu.
- 3 Select the [Print Options] panel.
- 4 Select [Narrow] or [Wide] according to the corrected amount from [Trapping] in the [Quality1] tab.
- 5 Specify other settings as necessary, and click [Print].



- If there is no detail settings displayed in the [Print] screen, click [Show details] at the bottom of the screen.

Useful functions

This section describes useful functions for printing from a PC.

Printing with multiple pages sorted into one complete set (Collate)

You can print the print data of multiple pages and put them into one complete set.



- Some applications may not be available.

For Windows PCL printer driver

- 1 Open the file to be printed.
- 2 Click [Print] from the [File] menu.
- 3 Click [Preferences].
- 4 Select the [Job Options] tab.
- 5 Input the number of copies in [Copies], and check [Collate].
- 6 Specify other settings as necessary, and click [OK].
- 7 Click [Print] in the [Print] screen.

For Windows PS printer driver

- 1 Open the file to be printed.
- 2 Click [Print] from the [File] menu.
- 3 Click [Preferences].
- 4 Input the number of copies in [Copies] of the [Job Options] tab, and check [Collate].
- 5 Specify other settings as necessary, and click [OK].
- 6 Click [Print] in the [Print] screen.



- Turn off the Collate function in the application.
If the Collate function is on in the application, you can print without using the memory of this machine.

For macOS

- 1 Open the file to be printed.
- 2 Select [Print] from the [File] menu.
- 3 Input the number of copies in [Copies].
- 4 Select the [Paper Handling] panel, and uncheck [Collate pages].
- 5 Select the [Print Setup] panel, and check [Collate] in the [Paper Setup] tab.
- 6 Specify other settings as necessary, and click [Print].



- If there is no detail settings displayed in the [Print] screen, click [Show details] at the bottom of the screen.
- If [Collate] is checked in the [Paper Handling] panel, you can print without using the memory of this machine.

Printing from the last page of your document

You can print the pages either in order or in reverse order.

When the output tray is used, printouts will be stacked in page order if it is set to print in order.

When the rear output tray is used, printouts will be stacked in page order if it is set to print in reverse order.



- If the rear output tray is not opened, printouts will be discharged from the output tray.
- This function is not available to the Windows PCL printer driver.

For Windows PS printer driver

- 1 Open the file to be printed.
- 2 Select [Print] from the [File] menu.
- 3 Click [Preferences].
- 4 Select [Back to Front] from [Page Order] in the [Layout] tab.
- 5 Specify other settings as necessary, and click [OK].
- 6 Click [Print] in the [Print] screen.



- If [Page Order] is not displayed, open the "Devices and Printers", right-click on the [OKI C650 PS] icon, and select [Printer properties] - [Advanced] tab. Check [Enable advanced printing features]. To open the "Devices and Printers", see "[How to open the printer folder\(P.142\)](#)".

For macOS

- 1 Open the file to be printed.
- 2 Select [Print] from the [File] menu.
- 3 Select [Reverse] in [Page Order] on the [Paper Handling] panel.
- 4 Specify other settings as necessary, and click [Print].



- If there is no detail settings displayed in the [Print] screen, click [Show details] at the bottom of the screen.

Printing by automatically selecting a tray for the specified paper

The tray (paper trays (Tray1-4), or the MP tray) matching the paper size and type that are set in the printer driver will be selected automatically for printing. Trays are selected according to the setting of [Tray Sequence].



- Be sure to set the paper size and paper weight for the paper tray and MP tray on the operator panel.
[Loading paper\(P.72\)](#)

When using the MP tray

By default, [When Mismatching] is set for the MP tray. In this case, the MP tray is not subject to auto tray switch.

To set the MP tray as a target for auto tray switch, use the following settings.

- 1 Check that "Ready To Print" appears on the display.

 - If the machine is in the power save mode, press «POWER SAVE» to restore.
- 2 Press «Fn» on the operator panel.
- 3 On the functional number screen, press «9», «5» and «OK».
- 4 Press the scroll button ▲ to select [Normal Tray], and press «OK».
- 5 Press «ON LINE» to return to the standby screen.

For Windows PCL printer driver

- 1 Open the file to be printed.
- 2 Select [Print] from the [File] menu.
- 3 Click [Preferences].
- 4 Select [Auto] in [Source] of the [Setup] tab.
- 5 Specify other settings as necessary, and click [OK].
- 6 Click [Print] in the [Print] screen.

For Windows PS printer driver

- 1 Open the file to be printed.
- 2 Select [Print] from the [File] menu.
- 3 Click [Preferences].
- 4 Select [Automatically Select] in [Paper Source] of the [Paper/Quality] tab.
- 5 Specify other settings as necessary, and click [OK].
- 6 Click [Print] in the [Print] screen.

For macOS

- 1 Open the file to be printed.
- 2 Select [Print] from the [File] menu.
- 3 Select [Auto Select] in [All Pages From] on the [Paper Feed] panel.
- 4 Specify other settings as necessary, and click [Print].



- If there is no detail settings displayed in the [Print] screen, click [Show details] at the bottom of the screen.

Switching tray automatically at running out of paper

When the paper loaded in the trays (paper trays (Tray1-4) or the MP tray) is of the same media size, media weight and media type, you can set that the machine will continue the printing from another tray when the feeding tray is empty.

First, select Auto Tray Switch from the operator panel. Then, select Auto Tray Switch in the printer driver.





- Configure the same paper settings of the tray to be used for both the machine and the printer driver.
[Loading paper\(P.72\)](#)

When using the MP tray

By default, [When Mismatching] is set for the MP tray. In this case, the MP tray is not subject to auto tray switch.

To set the MP tray as a target for auto tray switch, use the following settings.

- 1 Check that "Ready To Print" appears on the display.

 - If the machine is in the power save mode, press «POWER SAVE» to restore.
- 2 Press «Fn» on the operator panel.
- 3 On the functional number screen, press «9», «5» and «OK».
- 4 Press the scroll button ▲ to select [Normal Tray], and press «OK».

 - Trays are switched according to the setting of [Tray Sequence].
- 5 Press «ON LINE» to return to the standby screen.

For Windows PCL printer driver

- 1 Open the file to be printed.
- 2 Select [Print] from the [File] menu.
- 3 Click [Preferences].
- 4 Click [Paper Feed Options] in the [Setup] tab.
- 5 Check [Auto Tray Change] in [Paper feed options], and click [OK].
- 6 Specify other settings as necessary, and click [OK].
- 7 Click [Print] in the [Print] screen.

For Windows PS printer driver

- 1 Open the file to be printed.
- 2 Select [Print] from the [File] menu.
- 3 Click [Preferences].
- 4 Click [Advanced] in the [Layout] tab.
- 5 From [Tray Switch] in [Printer Features], select [On].
- 6 Click [OK].
- 7 Specify other settings as necessary, and click [OK].
- 8 Click [Print] in the [Print] screen.

For macOS

- 1 Open the file to be printed.

- 2 Select [Print] from the [File] menu.
- 3 Select the [Print Options] panel.
- 4 Check [Tray Switch] in the [Feed] tab.
- 5 Specify other settings as necessary, and click [Print].



- If there is no detail settings displayed in the [Print] screen, click [Show details] at the bottom of the screen.

Changing default settings of the printer driver

You can set those frequently used functions as the default settings of the printer driver.

For Windows

- 1 Open the "Devices and Printers".
[How to open the printer folder\(P.142\)](#)
- 2 Right-click on the icon [OKI C650 *], and select [Printing preferences].
 * represents the type of printer driver you want to use.
- 3 Configure the print settings to be used as the default settings of the printer driver.
- 4 Click [OK].

For macOS

- 1 Open the file to be printed.
- 2 Select [Print] from the [File] menu.
- 3 Configure the print settings to be used as the default settings of the printer driver.
- 4 Select [Save Current Settings as Preset] from [Presets].
- 5 Input a name for the setting, and click [OK].
- 6 Click [Cancel].



- To use the saved setting, select the set name from the [Presets] in the print screen.

Printing with frequently used settings registered in the printer driver

Registering frequently used settings

You can save the settings in the printer driver.



- This function is not available to the Windows PS printer driver.

For Windows PCL printer driver



- Up to 14 settings can be saved.

- 1 Open the "Devices and Printers".
[How to open the printer folder\(P.142\)](#)

- 2 Right-click on the icon [OKI C650 PCL6], and select [Printing preferences].
- 3 Set the print setup you want to save.
- 4 In the [Setup] tab, click [Save] in the [Driver Settings].
- 5 Specify a name for the setting to save, and click [OK].
- 6 Click [OK] to close the [Printing preferences] screen.

For macOS



- You can change the default settings on the [Page Setup] screen.
- Settings saved with other printer drivers cannot not be guaranteed. Save the setting with a name that identifies the model name.

- 1 Open the file to be printed.
- 2 Select [Print] from the [File] menu.
- 3 Set the print setup you want to save.
- 4 Select [Save Current Settings as Preset...] from [Presets].
- 5 Input a preset name, and click [OK].

Printing with registered settings



- This function is not available to the Windows PS printer driver.

For Windows PCL printer driver

- 1 Open the file to be printed.
- 2 Select [Print] from the [File] menu.
- 3 Click [Preferences].
- 4 Select the setting name to be used from [Driver Setting] in the [Setup] tab.
- 5 Click [OK].
- 6 Click [Print] in the [Print] screen.

For macOS

- 1 Open the file to be printed.
- 2 Select [Print] from the [File] menu.
- 3 Select the setting to be used from [Presets].
- 4 Click [Print].



- When you select [Show Presets] from [Presets] and uncheck [Reset Preset Menu to "Default Settings" after Printing], the preset you set will always be applied.

Printing data stored in this machine

The print data can be stored in the built-in memory of this machine. Because the work on the PC completes more quickly, the PC can do other work while the machine is operating in the background.



- If the spooled data cannot be stored due to insufficient capacity of the memory, a message is displayed indicating that the file system is full and the printing will not be performed.

For Windows PCL printer driver

- 1 Open the file to be printed.
- 2 Select [Print] from the [File] menu.
- 3 Click [Preferences].
- 4 Select the [Job Options] tab.
- 5 Click [Advanced].
- 6 Select [Job Spool], select [ON] for [Settings], and click [OK].
- 7 Specify other settings as necessary, and click [OK].
- 8 Click [Print] in the [Print] screen.

For Windows PS printer driver

- 1 Open the file to be printed.
- 2 Select [Print] from the [File] menu.
- 3 Click [Preferences].
- 4 Select the [Job Options] tab.
- 5 Click [Advanced].
- 6 Check [Job Spool], and click [OK].
- 7 Specify other settings as necessary, and click [OK].
- 8 Click [Print] in the [Print] screen.

For macOS

- 1 Open the file to be printed.
- 2 Select [Print] from the [File] menu.
- 3 Select the [Print Options] panel.
- 4 In the [Quality2] tab, check [Job Spool].
- 5 Specify other settings as necessary, and click [Print].



- If there is no detail settings displayed in the [Print] screen, click [Show details] at the bottom of the screen.

Printing data from a USB memory

You can connect a USB memory to this machine, and print the data saved on it.



- We do not guarantee the use of all USB memory products (The USB memory with security function is not supported).
- Not compatible with USB 3.0.
- Not compatible with the USB Hub or external USB-HDD.
- Not compatible with encrypted PDF.



- Compatible with FAT12, FAT16 and FAT32.
- Compatible with PDF (v1.7), JPEG, TIFF (v6 baseline), PRN (PS, PCL), and OBC.
- Refer to "[Printing QR codes or barcodes\(P.187\)](#)" for printing files in the OBC format.
- Create data in ASCII form.
- Compatible with a maximum of 32GB USB memory.
- Among all the files saved in the USB memory with the compatible file format, a maximum of 100 files are displayed in the file list.
 - The file list will not be displayed correctly if more than 100 files are stored on the USB memory.
 - Files may not be read correctly from the USB memory with a directory structure of 20 or more layers.
 - Files with a path length of over 240 characters may not be read correctly.
- Only one file in the USB memory can be printed at a time.

1 Insert the USB memory to the accessory connector (ACC) of this machine.

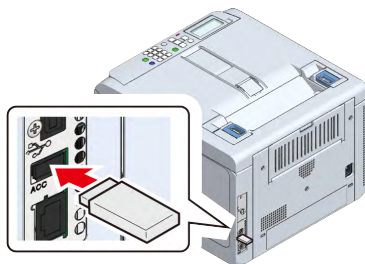

2 Check that [Select File] is displayed, and press the scroll button ▲ or ▼ to select the file to print, and press «OK».

3 To set the number of printing sheets and other items, press ▼ to select [Print Setup] and press «OK».

After completing the settings, press «BACK» to return to the screen of the file you want to print.

4 Press ▼ or ▼ to select [Execute], and press «OK».

The screen returns to the file list screen once the printing is completed. To continue printing, select the file from [Select File] and repeat Steps 4 and 5.

If you do not want to continue printing, press «ON LINE».

5 You can remove the USB memory when a message appears indicating that you can safely remove it.

Canceling the printing

To cancel the printing from the USB memory, press «CANCEL» on the operator panel.

Please see "[Canceling the printing\(P.192\)](#)" for details.



- The pages ready for printing in this machine will be printed as they are.

Printing QR codes or barcodes

You can print a QR code or barcode if you save the file containing the URL or the like in the OBC format to a USB memory, then connect the USB memory to this machine and finally print the file.

Before printing, specify the number of rows and columns in which one QR code or barcode is to be placed on one sheet of paper.

The printable formats are as follows. The factory default setting is [QRCode].

QRCode, UPC-A, UPC-A +2, UPC-A +5, UPC-E, UPC-E +2, UPC-E +5, EAN/JAN-8, EAN/JAN-8 +2, EAN/JAN-8 +5, EAN/JAN-13, EAN/JAN-13 +2, EAN/JAN-13 +5,

Interleaved2of5, Interleaved2of5 + CHK, Code39, Code39 + CHK, Code128 autoswitch, Code128 A, Code128 B, Code128 C, EAN/UCC-128, CODABAR,

CODABAR + CHKmod16, ZIP +4 POSTNET 5, ZIP +4 POSTNET 9, ZIP +4 POSTNET 11, and custom barcodes

This section uses Notepad (a Windows accessory application) as an example.

- 1 Attach a USB memory to your computer.
- 2 Open Notepad, and input the text string you want to display when scanning the QR code or barcode.
 -  Only one type of QR codes or barcodes can be printed in one file.
- 3 After you have finished the input, select [File] - [Save as], and click on the USB memory.
- 4 Select [All Files] from [File Type].
- 5 Input any text string with an extension of [.obc] in [File Name], and click [Save].
Example of the file name: aaaaa.obc
- 6 Close Notepad.
- 7 Remove the USB memory from the computer.
- 8 Insert the USB memory to the accessory connector (ACC) of this machine.
- 9 Check that [Select Print File] appears on the display, press the scroll button ▲ or ▼ to select the file to be printed, and press «OK».
- 10 Press ▼ to select [Barcode Print Setup], and press «OK».
- 11 Input the number of QR codes or barcodes to be printed using the numeric keypad since [Repeat] is selected, and press «OK».
- 12 Press ▼ to select [Layout Rows], and press «OK».
- 13 Input the number of rows to be printed on one page using the numeric keypad, and press «OK».
- 14 Press ▼ to select [Layout Columns], and press «OK».
- 15 Input the number of rows to be printed on one page using the numeric keypad, and press «OK».
- 16 Press ▼ to select [Barcode Type], and press «OK».
- 17 Press ▲ or ▼ to select the type of the barcode to be printed, and press «OK».
- 18 Press «BACK» to return to the screen of the file you want to print.

19 Press ▲ or ▼ to select [Print], and press «OK».



- If the text string in the file (.obc) does not meet the standard of the QR code or barcode to be printed, X is printed on the QR code or barcode.
- If there is no text string in the file (.obc), a blank page is printed.

Printing PS errors

You can print the error content when a PostScript error occurs.



- This function is not applicable to the PCL printer driver or macOS.

- 1 Open the file to be printed.
- 2 Select [Print] from the [File] menu.
- 3 Click [Preferences].
- 4 Click [Advanced] in the [Layout] tab.
- 5 Click [Send PostScript Error Handler] under [PostScript Options], and select [Yes] from the drop-down list.
- 6 Click [OK] until the [Printing preferences] is closed.
- 7 Click [Print] in the [Print] screen.

Editing margins

You can extend the margins to the top, bottom, left, and right to 30.0 mm/1.18 inches, change the printable area, and print on the paper to be printed.



- This function is available to the Windows PCL printer driver only.

- 1 Open the file to be printed.
- 2 Select [Print] from the [File] menu.
- 3 Click [Preferences].
- 4 Select the [Job Options] tab.
- 5 Click [Advanced].
- 6 Select [Edit Margins] in [Item], set it to [On] in [Settings], and click [Options].
- 7 Input margin values for [Top], [Bottom], [Left] and [Right], and click [OK].
- 8 Click [OK].
- 9 Specify other settings as necessary, and click [OK].
- 10 Click [Print] in the [Print] screen.

Correcting the print position of the tray

You can correct the print start position vertically and horizontally on paper for each tray. Set the correction volume in increments of 0.25 mm on the operator panel.

[X Adjust] and [Y Adjust] correct the simplex printing and the back side (the printing side fed from the tray) of duplex printing.

[Duplex X Adjust] and [Duplex Y Adjust] correct the face side (the printing side fed from the duplex unit) of duplex printing.



- The thick arrows in the figure indicate the paper feed direction.
- X indicates the vertical direction of paper travel, and Y the horizontal direction of paper travel.
- Correct with [+] to widen the blank space in the X direction, and [+] to widen the blank space in the Y direction.
- Readjustment might be necessary depending on the usage conditions (temperature and humidity/media type).
- This function corrects the position and does not improve the writing start position ($\pm 2\text{mm}$).

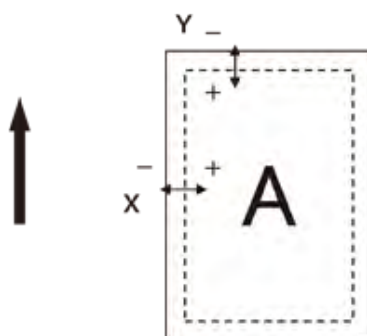

- The corresponding function numbers for each tray are listed below.

Target tray	Function number
Multi-purpose tray (MP tray)	220
Tray 1	221
Tray 2	222
Tray 3	223
Tray 4	224

1 Check that "Ready To Print" appears on the display.



- If the machine is in the power save mode, press «POWER SAVE» to restore.

2 Press «Fn» on the operator panel.

3 When the function number screen is displayed, press the function number of the tray you want to correct, and then press «OK».

4 Press the scroll button ▲ or ▼ to select the time to correct.

5 Press «OK».

6 Press ▲ or ▼ to select the correction volume, and press «OK». Make sure that a check is displayed to the left of the selected value.

7 Press «ON LINE» to return to the standby screen.

Printing with print data encrypted and password set (Private Print)

When printing private jobs, to prevent others from seeing the printing results of personal and confidential documents, the print data is encrypted and saved with a password in the machine's memory, and it is authenticated and printed from the operator panel.

Because the print data is sent encryptedly, unauthorized access to confidential information can be prevented.



- If the spooled data cannot be stored due to insufficient capacity of this machine's internal memory, a message is displayed indicating that the file system is full and the printing will not be performed.
- When using a print server for network sharing on this machine, the Windows PCL printer driver cannot use this function in conjunction with the poster printing or booklet printing.
- To use this function, uncheck [Job Spool].
[🔗 Printing data stored in this machine\(P.185\)](#)

Setting encryption/password on the PC

For Windows PCL printer driver

- 1 Open the file to be printed.
- 2 Select [Print] from the [File] menu.
- 3 Click [Preferences].
- 4 Select the [Job Options] tab.
- 5 Select [Job Type] of [Private Print].
- 6 Input any password in [Password] of [Job Type Option].
- 7 Click [OK].
- 8 Specify other settings as necessary, and click [OK].
- 9 Click [Print] in the [Print] screen.

Only the print data with a password set for encryption is sent to this machine, but without printing.

For Windows PS printer driver

- 1 Open the file to be printed.
- 2 Select [Print] from the [File] menu.
- 3 Click [Preferences].
- 4 Select the [Job Options] tab.
- 5 Select [Job Type] from [Private Print].
- 6 Input the password in [Password] of [Job Type Option].
- 7 Click [OK].
- 8 Specify other settings as necessary, and click [OK].
- 9 Click [Print] in the [Print] screen.

Only the print data with a password set for encryption is sent to this machine, but without printing.

For macOS

- 1 Open the file to be printed.
- 2 Select [Print] from the [File] menu.
- 3 Select the [Secure Print] panel.
- 4 Select [Job Type] of [Secure Print].
- 5 Input the password in [Job Password].
- 6 Specify other settings as necessary, and click [Print].

Only the print data with a password set for encryption is sent to this machine, but without printing.



- If there is no detail settings displayed in the [Print] screen, click [Show details] at the bottom of the screen.

Printing a document with encryption/password set from this machine

You can print the encrypted print data with a password saved in the machine's internal memory.

- 1 Check that "Ready To Print" appears on the display.
 - If the machine is in the power save mode, press «POWER SAVE» to restore.
- 2 Press «Fn» on the operator panel.
- 3 On the functional number screen, press «2» and «OK».
- 4 When the User List appears, select the user name of your PC and press «OK».
- 5 Input the password set on the PC, and press «OK».
- 6 When a list of private jobs appears, press the scroll button ▲ or ▼ to select the print data to print and press «OK».
- 7 Check that [Execute] is selected, and press «OK».

Select [Delete] and press «OK» to delete the specified print data.



- The print data saved in the memory is automatically deleted when the print data has been printed or has not been printed after a certain period of time. If an error occurs sending data or it is detected that the print data has changed since it was sent from the PC, the print data will be deleted automatically.

Canceling the printing

To cancel the data being printed or ready to print, press «CANCEL» for a short time (2 seconds or less) on the operator panel.



- You can change how long the button is pressed from [Cancel Key Behavior] of the menu items.

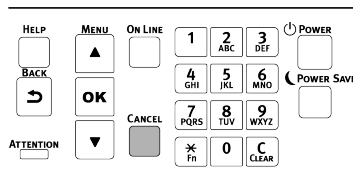

If you press «CANCEL», the following screen will be displayed.

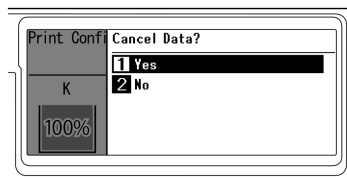

To cancel the printing, select [Yes] and press «OK».

To continue the printing, select [No] and press «OK».

If no operation is done within 3 minutes while this screen is displayed, the screen display will disappear and printing will continue.

Canceling the printing from the PC

Cancel the printing from your PC if you accidentally send a large amount of data from your PC to the printer.

For Windows

- Open the "Devices and Printers".
[How to open the printer folder\(P.142\)](#)
- Right-click on the printer's icon, and select [See what's printing].
- Select the name of the file that you want to cancel printing.
- Press the <Delete> key on the keyboard.
- Check the operator panel of this machine.
 If "Processing" or "Data Present" is displayed, cancel the printing from this machine's operator panel.

For macOS

- Select [System Preferences] from the Apple menu.
- Click [Printers & Scanners].
- Click the icon of the printer.
- Click [Open the Print Queue...].
- Select the name of the file that you want to cancel printing.
- Click [x].

7 Check the operator panel of this machine.

If "Processing" or "Data Present" is displayed, cancel the printing from this machine's operator panel.

6**Management of this machine**

Admin password.....	195
Changing settings of Admin Setup.....	200
Web page (Managing this machine from a PC).....	201
User restriction (Access control)	225
Initializing the settings	237
Moving/Transporting this machine	239
Disposal.....	243

Admin password

The admin password is used to change the settings of the machine.

We recommend you to change the admin password to protect your personal information.

Checking the factory default admin passwords

The factory default admin password is set to a 10-digit value of this machine's serial number with upper-case letters converted to lower-case ones.

Examples of serial number and admin password

Item	Example	Value checked by customer
Serial number	AB01234567	
Admin password	ab01234567	



- The serial number may be displayed as [Serial Number] or [Serial No.].

Check the machine's serial number with one of the following methods.

- Check by the display on the operator panel.
- Check by printing the menu map.
- Check against the sticker inside the machine.

This section explains the procedure assuming that the machine's serial number is "AB01234567".

Checking by the display on the operator panel



- On the operator panel, the serial number is displayed as [Serial Number].

- Press the scroll button ▼ on the operator panel several times to select [Configuration], and press «OK».

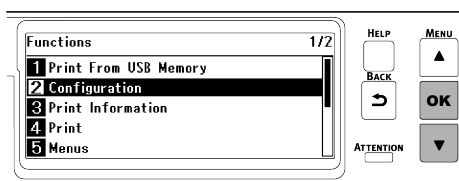

- Press ▼ or ▲ several times to select [System], and press «OK».

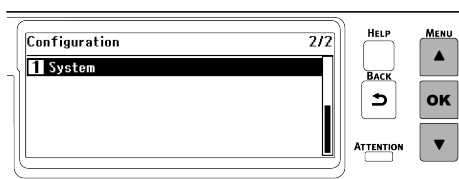

- 3 Check that [Serial Number] is selected, and press «OK».

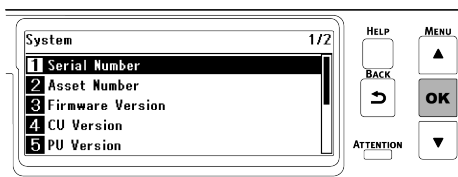

- 4 Check the 10-digit alphanumeric characters displayed in [Serial Number].

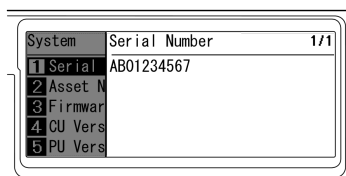

- 5 Convert the upper-case letters of [Serial Number] into lower-case ones and use the converted string as the admin password.

Checking by printing the menu map



- On the menu map, the serial number is displayed as [Serial Number].

- 1 Print the menu map.

[Printing the menu map \(configuration\)\(P.86\)](#)

- 2 Check [Serial Number].

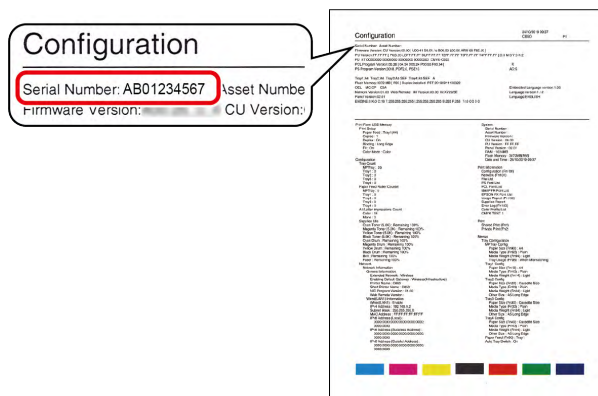

- 3 Convert the upper-case letters of [Serial Number] into lower-case ones and use the converted string as the admin password.

Checking against the sticker inside the machine

- 1 Pull the front cover open lever (blue) to open the front cover.

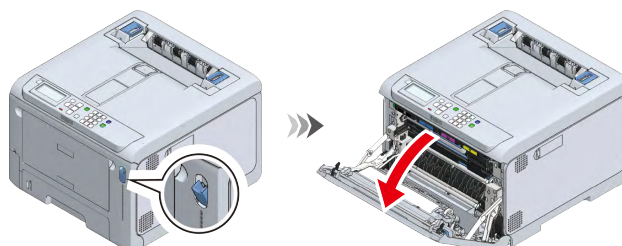

- 2 Check the leftmost 10 digits of the alphanumeric characters written on the sticker on the left to the L2 lever.

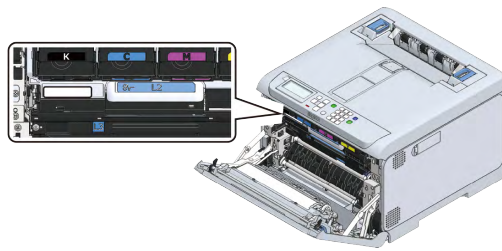

- 3 You may convert the upper-case letters into lower-case ones and use the converted string as the admin password.

Inputting the factory default admin passwords

This section explains the procedure assuming that the factory default admin password is "ab01234567".

 [Checking the factory default admin passwords\(P.195\)](#)

- 1 Check that "Ready To Print" appears on the display.



- If the machine is in the power save mode, press «POWER SAVE» to restore.

- 2 Press the scroll button ▼ on the operator panel several times to select [Admin Setup], and press «OK».
- 3 Press «2» twice using the numeric keypad to confirm that "a" is displayed, and press «OK». The entered character is displayed in "*" and the cursor moves to the next position.

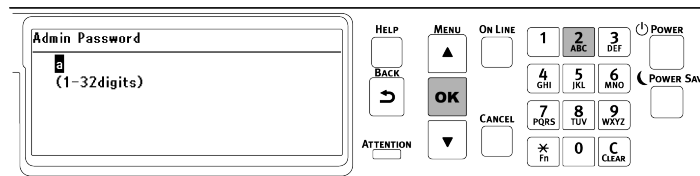

- 4 Press «2» for three times to confirm that "b" is displayed, and press «OK».

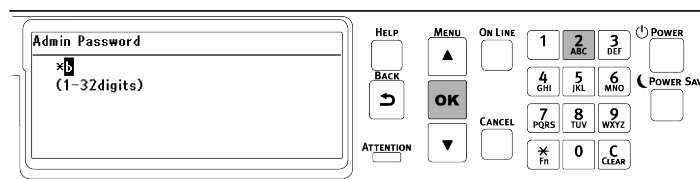

- 5 Press «0» and then «OK».

- 6 Press «1».



- It is not necessary to press «OK» since «1» is confirmed by one press.

- 7 Press «2» and then «OK».

- 8 Input the remaining characters by the same procedure.

- 9 Press «OK» again to complete inputting the admin password and display [Admin Setup].

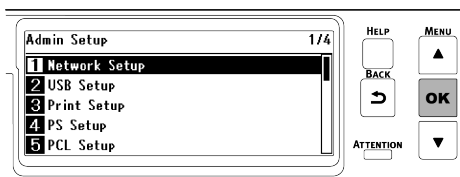

Changing the admin password

The admin password can consist of 1 to 32 digits.

The following characters can be used for the admin password.

- Upper-case letters
- Lower-case letters
- Figures
- Symbols: [Space] ! " # \$ % & ' () * + , - . / : ; < = > ? @ [¥] ^ _ ` { | } ~



- Be sure to write down the password you set just in case you forget.
- If you forget the changed password, you cannot change [Admin Setup] or [Boot Menu].
- If you wish to reset the password, the charged service by maintenance staff will be necessary.



- If the machine is in the power save mode, press «POWER SAVE» to restore.

This section describes how to change the factory default admin password as an example.

- 1 Check that "Ready To Print" appears on the display.



- If the machine is in the power save mode, press «POWER SAVE» to restore.

- 2 Press the scroll button ▼ on the operator panel several times to select [Admin Setup], and press «OK».

- 3 Input the factory default admin password.

[Inputting the factory default admin passwords\(P.197\)](#)

- 4 Press the scroll button ▲ or ▼ on the operator panel several times to select [Change Password], and press «OK».

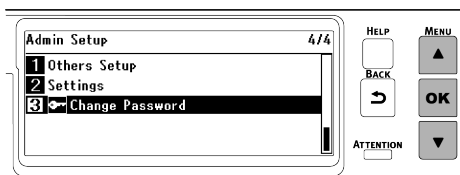

- 5 Enter a new password and press «OK».

[Inputting text\(P.93\)](#)

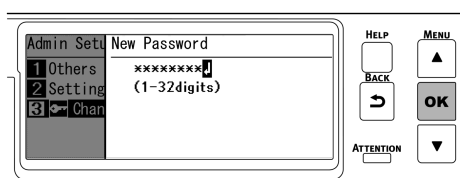

- 6 Press «OK» again to display the [Verify Password] screen.

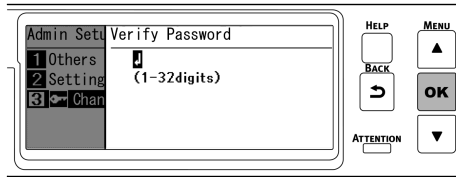

- 7 Input the password again, and press «OK».

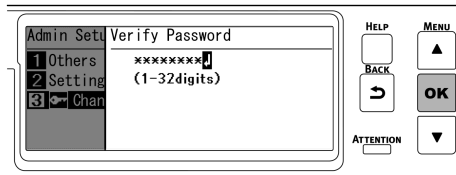

- 8 When «OK» is pressed again, the password has been changed and the screen returns to [Admin Setup].

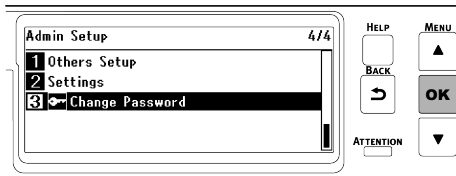

Admin password memo field	
---------------------------	--

Changing settings of Admin Setup

This section explains the procedure of changing settings of this machine as an administrator.

- 1 Check that "Ready To Print" appears on the display.

 - If the machine is in the power save mode, press «POWER SAVE» to restore.
- 2 Press the scroll button ▼ on the operator panel several times to select [Admin Setup], and press «OK».
- 3 Input the admin password using the numeric keypad, and press «OK».
[Admin password\(P.195\)](#)
- 4 Press ▲ or ▼ to select the menu for which you want to change the settings, and press «OK».
- 5 Press ▲ or ▼ to change the settings.
- 6 Press «OK».
- 7 Press «ON LINE» to return to the standby screen.

Web page (Managing this machine from a PC)

You can manage this machine by accessing the web page of this machine from a PC. What you can do with the web page is as follows. The web page can be used on both Windows and macOS.

- Displaying the state of this machine
- Setting up the tray, network, default settings of each function, and this machine
- Displaying the print data list
- Printing PDF files without printer driver
- Links to frequently used web pages



- To change settings of this machine from the web page, it is necessary to log in as an administrator.

Opening the web page



- Set the security level of your browser to medium or enable Cookies.

This section takes the following environment for example.

- Device name: C650
- IP address of this machine: 192.168.0.2

- 1 Start the web browser.
- 2 Input the URL "http:// (this machine's IP address)" in the address bar, and press the «Enter» key.
The IP address of this machine is available on the printed menu map.
[Printing the menu map \(configuration\)\(P.86\)](#)

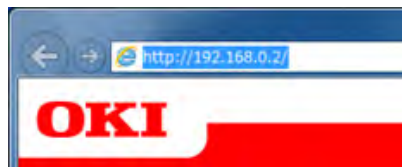

- If the IP address includes values of 1 or 2 digits, do not add "0" before such values. Otherwise, communication may fail.
 - Correct: http://192.168.0.2/
 - Wrong: http://192.168.000.002/

Logging in as an administrator

To change the settings of this machine using the web browser, it is necessary to log in as an administrator.

1 Click [Administrator Login].

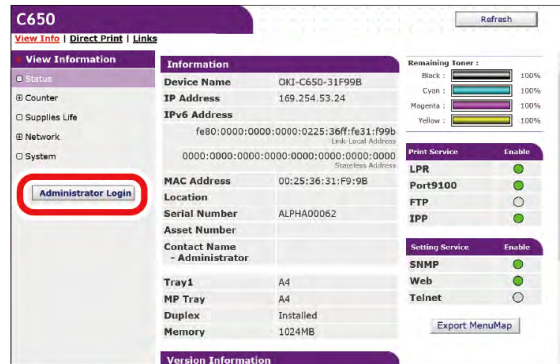

2 Input "admin" in [User Name] and the current password in [Password], and click [OK].

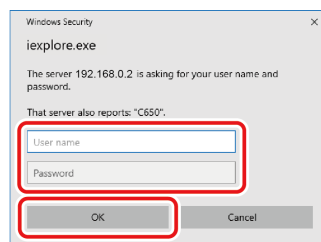

- The password is the same as "Admin Password" on the operator panel.
[Admin password\(P.195\)](#)
- When access control is enabled, you can log in as a local user with administrator privileges (with .AdminRole assigned).

3 The following screen is displayed.



Changing admin password (Web page)

You can change the admin password of this machine from the web page. The admin password specified on the web page is used to log into this machine or to change settings from the operator panel or web page.

The admin password can consist of 1 to 32 digits.

The following characters can be used for the admin password.

- Upper-case letters
- Lower-case letters
- Number
- Symbols: ! " # \$ % & ' () * + , - . / : ; < = > ? @ [¥] ^ _ ` { | } ~



- Be sure to write down the password you set just in case you forget.

- If you forget the admin password, you cannot change [Admin Setup] or [Boot Menu]. Or, if you wish to reset the password, the charged service by maintenance staff will be necessary.

1 Open the web page of this machine.

 [Opening the web page\(P.201\)](#)

2 Log in as an administrator.

 [Logging in as an administrator\(P.201\)](#)

3 Select [Admin Setup].

4 Select [Management] - [Admin Password].

5 Input the new password in [New Admin Password].

6 Input the new password again in [New Admin Password(Verify)].

The password you input is not displayed. Write down your password and keep it in a safe place.





7 Click [Submit].



- It is not necessary to restart the machine. The next time you log in as an administrator, use the new password.

Checking/Changing the state of this machine



- Set the security level of your browser to medium or enable Cookies.
- The admin password is required to enter [Admin Setup].
 [Changing admin password \(Web page\)\(P.202\)](#)
- To change settings of this machine from the web page, it is necessary to log in as an administrator.
 [Logging in as an administrator\(P.201\)](#)
- About network setup
 [Connecting via a wireless LAN\(P.41\)](#)
 [Connecting via a wired LAN\(P.36\)](#)

This section takes the following environment for example.

- Device name: C650
- IP address of this machine: 192.168.0.2

Checking the state of this machine

1 Open the web page of this machine.

 [Opening the web page\(P.201\)](#)

2 Log in as an administrator.

 [Logging in as an administrator\(P.201\)](#)

3 The following screen is displayed.

You can check the supplies life, print statistics, and network and system information of this machine.



Changing settings of this machine

You can change settings of this machine from the web page.

1 Open the web page of this machine.

[Opening the web page\(P.201\)](#)

2 Log in as an administrator.

[Logging in as an administrator\(P.201\)](#)

3 Change the settings, and click [Submit].

You can change settings of this machine from the following tabs.

- Paper Setup
You can set the paper size or media type for each tray.
- Admin Setup
- Job Lists
- Direct Print
- Links
- User Management

Saving configurations

The settings of this machine and the usage of consumables and maintenance parts can be saved as a CSV file.

1 Open the web page of this machine.

[Opening the web page\(P.201\)](#)

2 Click [Export MenuMap].

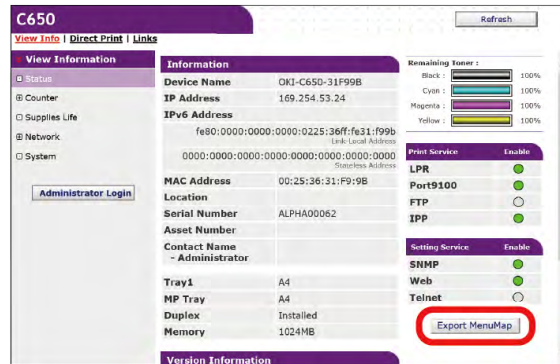

3 Save it with a name.

Communication encryption (SSL/TLS)

You can encrypt the communication between your PC and this machine. The communication is encrypted with SSL/TLS in the following cases.

A certificate is pre-installed on this machine to enable the communication using HTTPS.

Creating a certificate

You can use a certificate when sending data to this machine connected to a network. This section describes how to create a certificate from the web page.

The following two types of certificates can be created.

- Self-signed certificate
This certificate is issued by this machine.
- Certificate issued by certificate authority
This certificate is signed and issued by an external certificate authority for CSR (Certificate Signing Request) created by this machine.



- Before creating a certificate, make sure that the certificate already installed has been deleted.
- If an IP address is set in [Common Name] of the certificate, the certificate will be invalidated when the printer IP Address is changed after the certificate is created. Please create a certificate again.

1 Open the web page of this machine.

[Opening the web page](#)(P.201)

2 Log in as an administrator.

[Logging in as an administrator](#)(P.201)

3 Select [Admin Setup].

4 Select [Network] - [Security] - [SSL/TLS].

5 Click [Delete Certificate] to delete the certificate already installed.



- If the certificate has been removed, proceed to Step 6.

6 Configure the settings following the on-screen instructions.

- 7 Confirm the settings, and click [OK].
 - For a self-signed certificate, follow on-screen instructions to close the web page, and proceed to "Enabling encryption settings".
 - To obtain a certificate issued by a certificate authority, go to Step 7.
- 8 Send the CSR to the certificate authority by following on-screen instructions.
- 9 Click [OK].
- 10 Install the certificate from the certificate authority by following on-screen instructions.
- 11 Click [Submit].

See "Enabling encryption settings".

Importing a certificate and private key

This section describes how to import the certificate and private key from the web page.

You can also import the certificate and private key to use the certificate issued by an external certificate authority.

- 1 Open the web page of this machine.
 - [Opening the web page](#)(P.201)
- 2 Log in as an administrator.
 - [Logging in as an administrator](#)(P.201)
- 3 Select [Admin Setup].
- 4 Select [Network] - [Security] - [SSL/TLS].
- 5 Select [Using Certificate and Private Key after imported] to import the certificate.
 - 
 - You can import a certificate in PKCS#12 format.

See "Enabling encryption settings".

Enabling encryption settings

You can enable the encryption settings after creating a certificate. This section describes how to enable the encryption from the web page.

When the encryption is enabled, it will be encrypted from the communication immediately after changing the setting from the web page.



- 1 Open the web page of this machine.
 - [Opening the web page](#)(P.201)
- 2 Log in as an administrator.
 - [Logging in as an administrator](#)(P.201)
- 3 Select [Admin Setup].
- 4 Select [Network] - [Security] - [SSL/TLS].
- 5 Select [Enable] for the protocol you want to apply the encryption to.
- 6 Click [Submit].

Exporting a certificate

This section describes how to export a certificate from the web page.

Depending on the SSL/TLS communication function, your PC may require to trust the machine's certificate.

Import the exported certificate of the machine into the PC's trusted certificate store in order for the PC to trust the machine.

- 1 Open the web page of this machine.
 [Opening the web page\(P.201\)](#)
- 2 Log in as an administrator.
 [Logging in as an administrator\(P.201\)](#)
- 3 Select [Admin Setup].
- 4 Select [Network] - [Security] - [SSL/TLS].
- 5 Select [Export Certificate] to export the certificate.





- The certificate is exported in the PEM format.

Using IPP

Add this machine as an IPP printer in a PC.

For Windows

- 1 Open the "Devices and Printers", and select [Add Printer].
 [How to open the printer folder\(P.142\)](#)
- 2 In the [Add Printer] wizard, select [Add a Network, Wireless, or Bluetooth Printer].
- 3 Select [The printer that I want isn't listed] from the list of usable printers.
- 4 Select [Select a shared printer by name].
- 5 Input "http://(IP address of this machine)/ipp" or "http://(IP address of this machine)/ipp/lp", and click [Next].
- 6 Click [Have Disk].
- 7 Insert the included DVD to the PC.
If your PC does not come with a DVD drive, double-click on the driver software file downloaded from the website to unzip it.
- 8 Input the following values in [Copy manufacturer's files from], and click [Ref].
For installing the PCL printer driver: "D:¥Drivers¥_PCL"
For installing the PS printer driver: "D:¥Drivers¥_PS"

 - The above values are examples when the DVD drive is set to the D drive.
 - If your PC does not come with a DVD drive, specify the folder unzipped in Step 7.
- 9 Select the INF file, and click [OPEN].
- 10 Click [OK].
- 11 Select a model, and click [OK].
- 12 Click [Next].
- 13 Click [Completed].

- 14 When the installation has completed, print a test page.

For macOS

- 1 Insert the included DVD to the PC, and install the driver.
[Installing software](#)(P.247)
- 2 Select [System Preferences] from the Apple menu.
- 3 Click [Printers & Scanners].
- 4 Click [+].
- 5 Click the [IP] tab.
- 6 Select [IPP (Internet Printing Protocol)] in [Protocol].
- 7 Input the IP address of this machine in [Address].
- 8 Input "ipp" in [Cue].
- 9 Click [Add].
- 10 Click [Continue].
- 11 Check if this machine has been registered in [Printers & Scanners].

Communication encryption (IPSec)

You can encrypt the communication between your PC and this machine.

Encrypt the communication with IPSec. When IPSec is enabled, all applications are encrypted using IPSec.

You can specify 50 hosts per IP address. Any access to this machine from an unregistered host will be denied.

Any attempt to access an unregistered host will be invalidated.

Set up your PC after setting up this machine in advance.



- You need to prepare a pre-shared key beforehand.

Setting up this machine

To enable IPSec, it is necessary to configure the machine from the web page first.



- When IPSec is enabled, any communication with the host not specified in this step will be denied.
- IPSec communication is done when IPSec is set for this machine and the host. If IPSec is not set on the host, IPSec communication will not be done.
- Be sure to make a note of the values you specify in this step. They will be required to configure IPSec settings on a PC.

- 1 Open the web page of this machine.
[Opening the web page](#)(P.201)
- 2 Log in as an administrator.
[Logging in as an administrator](#)(P.201)
- 3 Select [Admin Setup].
- 4 Select [Network] - [Security] - [IPSec].

5 Configure the settings following the on-screen instructions.



- For the "Phase 2 Proposal" setting, [AH] or [ESP] must be enabled.
- [AH] and [ESP] cannot be used simultaneously. When both [AH] and [ESP] are enabled, only [ESP] is used.

6 Click [Submit].

The new settings will take effect after the network function of the machine has been reset.



- If IPsec cannot be set up due to the inconsistency of specified parameters, the web page cannot be accessed. In this case, disable IPsec or initialize network settings from the operator panel of this machine.

Go to "[Setting up your PC](#)".

Setting up your PC

It is necessary to set IPsec on your PC. For the setting method on the PC, please consult your network administrator.

Using the access control function (IP filter) with the IP address

You can use the IP Address to control the access to this machine. You can set whether to authorize setup or printing from the specified IP address. IP filtering is disabled by default.



- Be sure to specify the correct IP address. If you specify an incorrect IP Address, you will not be able to access the machine using the IP protocol.
- When IP filtering is enabled, any access to the host not specified in this setting will be denied.

1 Open the web page of this machine.

[Opening the web page](#)(P.201)

2 Log in as an administrator.

[Logging in as an administrator](#)(P.201)

3 Select [Admin Setup].

4 Select [Network] - [Security] - [IP Filtering].

5 Configure the settings following the on-screen instructions.



- If nothing is registered in [Administrator's IP Address setting], access to this machine may be disabled depending on the specified IP address range.
- If you are using a proxy server, [Your Current Local Host/Proxy IP Address] may not match the IP address of the current host.

6 Click [Submit].

The new settings will take effect after the network function of the machine has been reset.



- IP filtering is applicable only to IPv4.

Using the access control function with the MAC address

You can use the MAC Address to control the access to this machine. You can allow or deny the access from the specified MAC Address.



- Be sure to specify the correct MAC address. If you specify an incorrect MAC address, you will not be able to access the machine using the network.

1 Open the web page of this machine.

[Opening the web page](#)(P.201)

2 Log in as an administrator.

[Logging in as an administrator](#)(P.201)

3 Select [Admin Setup].

4 Select [Network] - [Security] - [MAC Address Filtering].

5 Configure the settings following the on-screen instructions.



- If nothing is registered in [Administrator's MAC Address setting], access to this machine may be disabled depending on the specified MAC address range.
- If you are using a proxy server, [Your Current Local Host/Proxy MAC Address] may not match the MAC address of the current host.

6 Click [Submit].

The new settings will take effect after the network function of the machine has been reset.



- You cannot specify the access control individually for each address.

Notifying errors via e-mail

Errors of consumables or maintenance parts are notified via e-mail. You can also set the timing of notification.

1 Open the web page of this machine.

[Opening the web page](#)(P.201)

2 Log in as an administrator.

[Logging in as an administrator](#)(P.201)

3 Select [Admin Setup].

4 Select [Network] - [Mail Server Setup].

5 Select [Enable] in [SMTP Send].

6 Input the e-mail server name or the address of e-mail server in [SMTP Server].

7 Set the mail address allocated to this machine in [Device E-mail Address].

8 Set appropriate values for other setting items if necessary.

9 Select [Network] - [Email] - [Alert Settings].

10 Input the e-mail address to receive notifications in [E-mail Alert Settings].

11 Click [Settings] for the email address you input.

If you want to apply the notification condition to another address, click [Copy].

- 12** When the [E-mail Alert Settings] screen is displayed, select appropriate settings in [Way of E-mail Alerting], and click [To STEP2].



- When you select [Upon occurrence of an event], an error is notified just once.
- When you select [Periodically], an error is notified periodically until it is cleared.

- 13** Configure the settings following the on-screen instructions.

- 14** Click [OK].

- 15** Click [View a summary of current configuration] to check the current settings, and click [X] to close the window.

You can also check the current settings of up to two addresses in the home window. Select the address you want to check from the list.

- 16** Click [Submit].

The new settings will take effect after the network function of the machine has been reset.



- If no notification target error occurs, the notification e-mail will not be sent.

Using SNMPv3

By using the SNMP manager that is compatible with SNMPv3, the management of this machine can be encrypted with SNMP.

- 1** Open the web page of this machine.

 [Opening the web page](#)(P.201)

- 2** Log in as an administrator.

 [Logging in as an administrator](#)(P.201)

- 3** Select [Admin Setup].

- 4** Select [Network] - [SNMP] - [Settings].

- 5** Configure the settings following the on-screen instructions.

- 6** Click [Submit].

The new settings will take effect after the network function of the machine has been reset.



- You can use a commercially-available SNMP manager to verify and change the settings of this machine. For the MIB of this machine, refer to the supplied DVD, and check the MIB definition file in the [Misc] - [MIB Files] folder.

Using IEEE802.1X (Wired LAN)

This machine is compatible with IEEE802.1X authentication. IEEE802.1X authentication is possible after IEEE802.1X authentication on the web page of this machine is enabled and the authentication switch is connected.

Setting with EAP-TLS

This section describes how to set up EAP-TLS, one of the IEEE802.1X authentication.

- 1 Open the web page of this machine.
[Opening the web page\(P.201\)](#)
- 2 Log in as an administrator.
[Logging in as an administrator\(P.201\)](#)
- 3 Select [Admin Setup].
- 4 Select [Network] - [IEEE802.1X].
- 5 Select [Enable] in [IEEE802.1X].
- 6 Select [EAP-TLS] in [EAP Type].
- 7 Input the user name in [EAP User].
- 8 Select [Not use SSL/TLS Certificate for EAP authentication], and click [Import].
- 9 Input the file name of the certificate.
Only PKCS#12 files can be imported.
- 10 Input the certificate password, and click [OK].
- 11 Select [Authenticate Server], and click [Import].
- 12 Input the file name of the CA certificate, and click [OK].
Specify the CA certificate used for RADIUS server authentication. PEM, DER and PKCS#7 files can be imported.
- 13 Click [Submit].
The new settings will take effect after the network function of the machine has been reset.
- 14 When the machine is online, power off the machine.
- 15 Remove the LAN cable from the machine.
- 16 Go to "[Connecting this machine to the authentication switch](#)".

Setting with PEAP

This section describes how to set up PEAP, one of the IEEE802.1X authentication.

- 1 Open the web page of this machine.
[Opening the web page\(P.201\)](#)
- 2 Log in as an administrator.
[Logging in as an administrator\(P.201\)](#)
- 3 Select [Admin Setup].
- 4 Select [Network] - [IEEE802.1X].
- 5 Select [Enable] in [IEEE802.1X].
- 6 Select [PEAP] in [EAP Type].
- 7 Input the user name in [EAP User].
- 8 Input the password in [EAP Password].
- 9 Select [Authenticate Server], and click [Import].
- 10 Input the file name of the CA certificate, and click [OK].
Specify the CA certificate used for RADIUS server authentication. PEM, DER and PKCS#7 files can be imported.

- 11 Click [Submit].
The new settings will take effect after the network function of the machine has been reset.
- 12 When the machine is online, power off the machine.
- 13 Remove the LAN cable from the machine.
- 14 Go to "[Connecting this machine to the authentication switch](#)".





Connecting this machine to the authentication switch

- 1 Check that this machine is powered off.
- 2 Connect the LAN cable to the network interface connector of this machine.
- 3 Connect the other end of the LAN cable to the authentication port of the authentication switch.
- 4 Power on this machine.
- 5 Set the IP address of this machine.

Setting IEEE802.1X (Wireless LAN)

You can set IEEE802.1X authentication with a wireless LAN. First, access the web page of this machine via a wired LAN to set IEEE802.1X authentication, and then set the wireless connection on the web page.

Setting with EAP-TLS

- 1 Open the web page of this machine.
 [Opening the web page](#)(P.201)
- 2 Log in as an administrator.
- 3 Select [Admin Setup].
 [Logging in as an administrator](#)(P.201)
- 4 Select [Network] - [IEEE802.1X].
- 5 Select [Disable] in [IEEE802.1X].
- 6 Select [EAP-TLS] in [EAP Type].
- 7 Input the user name in [EAP User].
- 8 Check [Not use SSL/TLS Certificate for EAP authentication], and click [Import].

 - If you select [Use SSL/TLS Certificate for EAP authentication], the certificate must be preset from the [SSL/TLS] menu.
- 9 Select the certificate file.
Only PKCS#12 files can be imported.
- 10 Input the certificate password, and click [OK].
- 11 Select [Authenticate Server], and click [Import].

 - When you select [Not Authenticate Server], go to Step 13.

12 Select the CA certificate file, and click [OK].



- Specify the CA certificate used for RADIUS server authentication. PEM, DER and PKCS#7 files can be imported.

13 Click [Submit].

14 When this machine is online, go to "[Connecting to a wireless LAN \(WPA/WPA2-EAP\)\(P.214\)](#)".

Setting with PEAP

1 Open the web page of this machine.



[Opening the web page\(P.201\)](#)

2 Log in as an administrator.



[Logging in as an administrator\(P.201\)](#)

3 Select [Admin Setup].

4 Select [Network] - [IEEE802.1X].

5 Select [Disable] in [IEEE802.1X].

6 Select [PEAP] in [EAP Type].

7 Input the user name in [EAP User].

8 Input the password in [EAP Password].

9 Select [Authenticate Server], and click [Import].



- When you select [Not Authenticate Server], go to Step 11.

10 Select the CA certificate file, and click [OK].



- Specify the CA certificate used for RADIUS server authentication. PEM, DER and PKCS#7 files can be imported.

11 Click [Submit].

12 When this machine is online, go to "[Connecting to a wireless LAN \(WPA/WPA2-EAP\)\(P.214\)](#)".

Connecting to a wireless LAN (WPA/WPA2-EAP)

This machine supports the wireless LAN security method WPA/WPA2-EAP.

Before setting WPA/WPA2-EAP as the wireless LAN security method, it is necessary to complete the wired or Wireless(AP Mode) network connection and set from the [IEEE802.1X] menu.

See "[Setting IEEE802.1X \(Wireless LAN\)\(P.213\)](#)".

1 Open the web page of this machine.



[Opening the web page\(P.201\)](#)

2 Log in as an administrator.



[Logging in as an administrator\(P.201\)](#)

3 Select [Admin Setup].

4 Select [Network] - [Wireless(Infrastructure)].

- 5 Select [Enable] in [Wireless(Infrastructure)] of [Basic Settings].

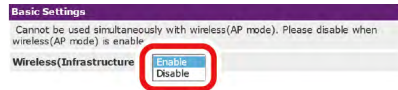

- The factory default setting is "Disable".

- 6 Select [Manually set the connection to access point] in [Wireless Network Selection].

- 7 Select [Next].

- 8 Input the SSID name of the Wireless(AP Mode) network to connect in [SSID].



- 9 Select [WPA/WPA2-EAP] in [Security] of [Security Settings].

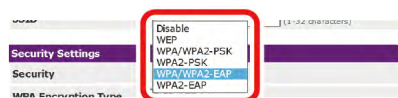

- 10 After all the basic settings and security settings are configured, click the [Submit] button on the lower left corner of the web screen to apply the settings. It may take about 1 minute to connect to the Wireless(AP Mode) network. If the connection fails, reset the wireless settings from the operator panel, or switch to wired LAN from the operator panel and reset the wireless settings from the web page.

Setting the LDAP server



- Consult your network administrator for the LDAP server and encryption setup.

- 1 Open the web page of this machine.

[Opening the web page](#)(P.201)

- 2 Log in as an administrator.

[Logging in as an administrator](#)(P.201)

- 3 Select [Admin Setup].

- 4 Select [Network] - [LDAP Server Setting].

- 5 Input the FQDN or IP address of the LDAP server in [LDAP Server].



- When selecting [Digest-MD5] or [Secure Protocol] for [Method] in Step 9, input the FQDN instead of the IP address. An FQDN is a combination of the host name and domain name. (Example of FQDN: Server1.domain.local)

- 6 Input the port number of the LDAP server in [Port Number].

- 7 In [Timeout], specify the timeout value to wait for the search result.

- 8 Specify the BaseDN to access the LDAP server in [Search Root].

9 In [Method], select the required authentication method.

[Anonymous]: Selected to access the LDAP server using anonymous authentication.

[Simple]: Selected to access the LDAP server using simple authentication.

[Digest-MD5]: Selected to access the LDAP server using Digest-MD5 authentication.

[Secure Protocol]: Selected to access the LDAP server using Secure Protocol (Kerberos) authentication.



- If [Anonymous] is selected, authentication will always be anonymous, even when the LDAP server is used for LDAP name authentication. If the LDAP server is used for LDAP name authentication, select any authentication method other than [Anonymous].



- If [Digest-MD5] is selected, it is required to set the DNS server.
- If [Secure Protocol] is selected, it is required to set the SMTP server, DNS server and secure protocol server.

10 If any option other than [Anonymous] is selected in Step 9, specify the user ID and password to login to the LDAP server.

11 Select an encryption type in [Encryption].

[None]: No encryption will be done.

[LDAPS]: The encryption will be done with the LDAPS method.

[STARTTLS]: The encryption will be done with the StartTLS method.

12 Click [Submit].

Setting E-mail receiving (Web page)

Set the protocol (POP3, SMTP, etc.) for this machine to receive e-mails.

1 Open the web page of this machine.

 [Opening the web page](#)(P.201)

2 Log in as an administrator.

 [Logging in as an administrator](#)(P.201)

3 Select [Admin Setup].

4 Click [Network] - [Mail Server] in the left side of the screen.

5 Set the mail server if necessary.

6 Click [Submit].

Setting the power save mode (Web page)

Set the time that will elapse before the power save mode is entered.

1 Open the web page of this machine.

 [Opening the web page](#)(P.201)

2 Log in as an administrator.

 [Logging in as an administrator](#)(P.201)

3 Click [Admin Setup].

4 Click [Management] - [Power Setup].

5 Select the desired switchover time from [Power Save Time], and click [Submit].

Setting the sleep mode (Web page)

Set the time that will elapse before the sleep mode is entered.

- 1 Open the web page of this machine.
[Opening the web page](#)(P.201)
- 2 Log in as an administrator.
[Logging in as an administrator](#)(P.201)
- 3 Click [Admin Setup].
- 4 Click [Management] - [Power Setup].
- 5 Select the desired switchover time from [Sleep Time], and click [Submit].

Setting "Auto Power Off" (Web page)

Sets the Auto Power Off function.

Enables the Auto Power Off function.

- 1 Open the web page of this machine.
[Opening the web page](#)(P.201)
- 2 Log in as an administrator.
[Logging in as an administrator](#)(P.201)
- 3 Click [Admin Setup].
- 4 Click [Management] - [Power Setup].
- 5 Select [Enable] from [Auto Power Off], and click [Submit].

Setting "Auto Power Off Time"

- 1 Open the web page of this machine.
[Opening the web page](#)(P.201)
- 2 Log in as an administrator.
[Logging in as an administrator](#)(P.201)
- 3 Click [Admin Setup].
- 4 Click [Management] - [Power Setup].
- 5 Select [Auto Power Off Time] from the transition time, and click [Submit].

Copying the setup information of this machine to other devices

Exporting settings of this machine

- 1 Open the web page of this machine.
[Opening the web page](#)(P.201)
- 2 Log in as an administrator.
[Logging in as an administrator](#)(P.201)

- 3 Click [Admin Setup].
- 4 Click [Management] - [Settings Cloning].
- 5 Click [Settings Export].

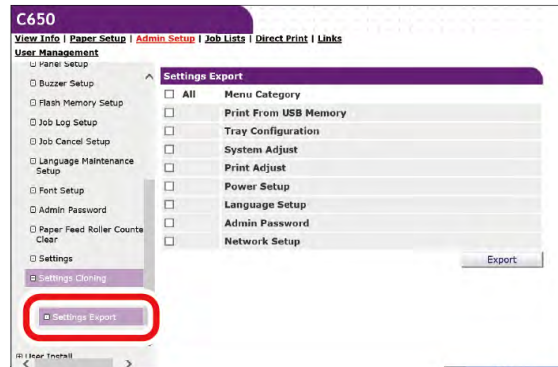

- 6 Select the settings to be copied.

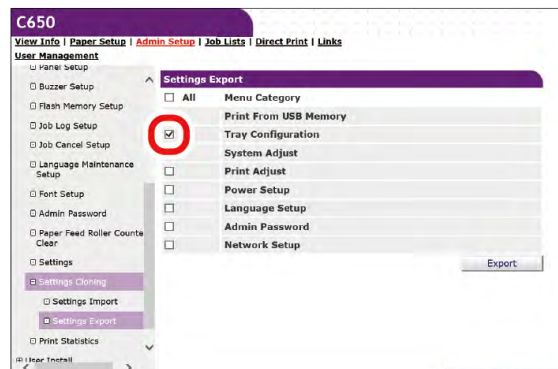

- 7 Click [Export].
- 8 Specify the storage location, name the file, and click [Save].



- The file may be saved without displaying the saving screen depending on the specific browser.

Importing settings of this machine

- 1 Open the web page of the device to which you want to copy the settings.
[Opening the web page](#)(P.201)
- 2 Log in as an administrator.
[Logging in as an administrator](#)(P.201)
- 3 Click [Admin Setup].
- 4 Click [Management] - [Settings Cloning].
- 5 Click [Browser], and select the copying file to export.
- 6 Click [Import].

Setting items of the web page

View Information



Item	Description
Status	Displays the current status of this machine. Displays all warnings and errors that have occurred in this machine as "Alert Information". Further, you can also check the operation status of each network service, information list, and IP addresses set in this machine.
Counter	Displays the quantity of printouts.
Supplies Life	Displays the remaining quantity of consumables and their service life.
Usage Report (displayed when you log in as an administrator of this machine)	Displays the Printer Usage Report.
Network	You can check network configurations such as general information, TCP/IP configurations and maintenance information.
System	Displays the information of this machine.

Paper Setup

This function is available when you log in as an administrator of this machine.

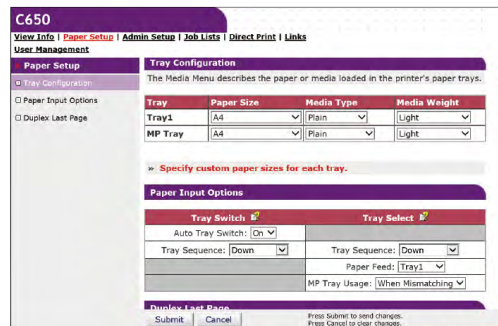

Item	Description
Tray Configuration	You can set the paper size, custom paper, etc. for each tray. Upon using the printer driver, the setup in the printer driver will take priority over this setting value.
Paper Input Options	Sets paper input options, tray switching and priority.
Duplex Last Page	Sets whether to print on both sides when the last page is single-sided.

Admin Setup

This function is available when you log in as an administrator of this machine.

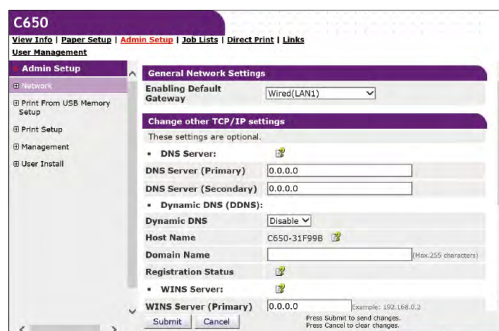

Network

Item		Description
General Network Settings		Sets the connection method of the network.
Wired(LAN1) Setup		Sets the standard wired LAN connection. You can disable the Energy Efficient Ethernet (EEE) function of the wired network (LAN1) by setting [Energy Efficient Ethernet] included in this item to [Disable].
Wireless(Infrastructure) Setting		Sets the wireless LAN (infrastructure) connection. Displayed when the wireless LAN module is installed and [Extended Network] is set to [Wireless].
Wireless(AP Mode) Setting		Sets the wireless LAN (AP mode) connection. Displayed when the wireless LAN module is installed and [Extended Network] is set to [Wireless].
NBT		Sets the information about NetBIOS over TCP.
Mail Server		Sets the information about the mail server.
Email	Receive Settings	Sets the reception of mails. Setting E-mail receiving (Web page) (P.216)
	Alert Settings	Sets the function to receive notifications by email when an error has occurred in this machine. Notifying errors via e-mail (P.210)
SNMP	Settings	Sets the information about SNMP.
	Trap	Sets the information about Trap of SNMP.
IPP	Settings	Sets the information about IPP printing.
	Authentication	Sets the information about authentication.
Windows Rally		Sets the information about Windows Rally.
AirPrint		Enables AirPrint.
IEEE802.1X		Sets the information related to IEEE802.1X/EAP.
Secure Protocol Server		Sets the information about the secure protocol server.
LDAP		Sets the information about the LDAP server.
Cloud Settings		Sets the information about the cloud connection.
Proxy		Sets the information about proxy.
Security	Protocol ON/OFF	Stops network protocols and network services that you do not use.
	IP Filtering	Restricts access by TCP/IP. Controls access from outside the company. However, this function requires knowledge about the IP address. This machine may be denied from access to network due to serious problems depending on settings.
	MAC Address Filtering	Restricts access by the MAC address. Controls access from outside the company. However, this function requires knowledge about the MAC address. This machine may be denied from access to network due to serious problems depending on settings.

Item		Description
	SSL/TLS	Encrypts communication between this machine and your PC (client).
	IPSec	Sets the encryption and tampering of communication between this machine and your PC (client).
	WebPage Authentication Method	Sets the web page authentication method.
Maintenance	Reset/Restore	Initializes or resets the network card. If it is reset, the web page will not be displayed even if you access from the web browser until you have reset. If it is initialized, the IP address will be reset to the initial state, and the information set manually will be lost. In that case, you will not be able to view the web page.
	Network Scale	This setting is to operate more efficiently on the network. When using a hub with a spanning tree function, this function is effective when the PC and this machine are connected on a one-to-one basis with a crossover cable.

Print From USB Memory Setup

Sets printing from the USB memory.

Item	Description
Default Settings	Sets the default value for printing from the USB memory.
Barcode Print Setup	Sets the initial value for printing barcodes.

Print Setup

Item		Description
Print Menu	Print Setup	Sets the number of copies, etc. Upon using the printer driver, the setup in the printer driver will take priority over this setting value.
	Printer Adjust	Sets the printer adjustment such as manual timeout and jam recovery.
	Print Position Adjust	Adjusts the print position such as X Adjust, Y Adjust, Duplex X Adjust, and Duplex Y Adjust.
	Drum Cleaning	Sets the image drum cleaning.
	Hex Dump	Displays all received print data in hexadecimal. This mode exits when this machine is restarted.
Color Menu		Sets the information about color.
System Configuration Menu		Sets various types of actions of this machine in correspondence to various situations such as personality and alarm release.
Emulation	PCL Setup	Sets the information about PCL.
	PS Setup	Sets the information about PS.
	IBM 5577 Setup	Sets the information about IBM 5577.
Private Print Setup	Verify job option	Specifies whether to verify the print data before printing. If enabled, printing is performed after verifying that the print data has not been changed. The integrity of print data is guaranteed, but the time to start printing will be longer.
	Erase job option	Sets the method for erasing the print data. Specifies that the data cannot be overwritten after it has been erased and cannot be restored. If you overwrite, it will take longer to erase. Value range: No overwrite/Zero out once
	Keep job for	Sets the retention period of the print data. After the print data is saved, if the print data is not printed after the set period, the print data is automatically deleted. Value range: 15 min/30 min/1 hour/2 hours/4 hours/8 hours/12 hours/1 day/2 days/3 days/4 days/5 days/6 days/7 days

Item		Description
	Job Limitation	Sets whether to save restricted print data. When [Private Print only] is selected, print data other than private print will not be accepted.
	Verify job password	Selects whether to verify the job password when the access control is enabled.
	Job Auto Search	Selects whether to perform job search at the same time as unlocking the panel when the access control is enabled.

Management

Sets the information about this machine.

Item		Description
Local Interface	USB Menu	Sets the information about USB.
Access Control Setup		Sets the access control function.
System Setup		Sets various types of actions of this machine in correspondence to various situations such as unit of measurement and alarm release.
Power Setup		Sets power save, sleep and auto power off.
Panel Setup		Sets the items to be displayed on the screen.
Buzzer Setup		Adjusts the volume when an error occurs, when the printing has completed, when AirPrint is checked, and when the IC card is held up (if the IC card reader is installed).
Flash Memory Setup		Used to initialize the flash memory and format a partition.
Job Log Setup		Sets whether to save the job log. Also used to clear saved job logs.
Job Cancel Setup		Sets the actions when «CANCEL» is pressed.
Language Maintenance Setup	Select Language	Sets the language for the screen display, the web page display and the report printing.
Font Setup		Sets the information about the font output mode.
Admin Password		Sets the admin password.
Paper Feed Roller Counter Clear		Clears the counter after the paper feed roller is replaced.
Settings		Save the data set in "Setting", and initialize the recalling.
Settings Cloning	Settings Import	Transmits settings of this machine which are saved and filed to the PC.
	Settings Export	File and save the settings of this machine to a PC.
Print Statistics		Enables or disables the counter of maintenance parts.

User Install

Item		Description
Setup		Sets the configurations checked over the network.
Time Setup		Sets the information about SNTP.
Other Settings		Sets the notification timing for the replacement of the image drum, fuser and belt unit.

Job Lists

This function is available when you log in as an administrator of this machine.

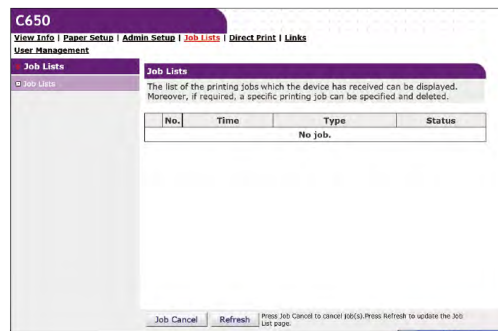

Item	Description
Job Lists	Displays a list of print data sent to this machine. You can delete unnecessary print data.

Direct Print

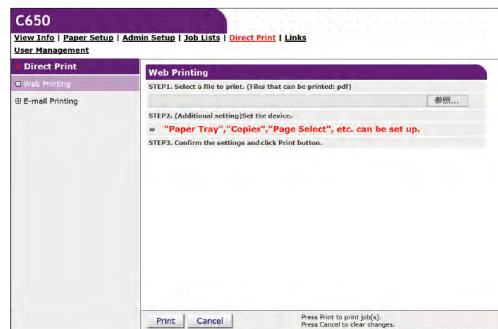

Item	Description	
Web Printing	Prints with any PDF file specified.	
E-mail Printing (displayed when you log in as an administrator of this machine)	E-mail Printing	Prints when a PDF, JPEG, or TIFF file is attached to an email received by this machine.
	Receive Settings	Sets the email reception.

Links

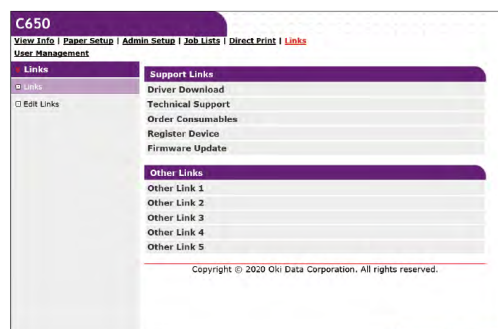

Item	Description
Links	Displays the links set by the administrator in addition to those set by the manufacturer.
Edit Links (displayed when you log in as an administrator of this machine)	Sets the administrator's favorite URL. You can register 5 support links and 5 other links. Input the URL including "http: /".

User Management

This function is available when you log in as an administrator of this machine.

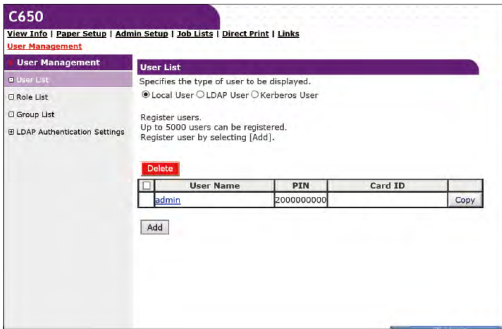

Item		Description
User List		Registers/Deletes a user to use this machine. A maximum of 5,000 users can be registered.
Role List		Manages the role assigned to the user. A maximum of 100 roles can be registered.
Group List		Manages users registered in this machine in group. Up to 1,000 groups can be registered.
LDAP Authentication Settings	LDAP Authentication Settings	Sets the user information, card ID and PIN required to use LDAP authentication.
	Role Assignment Regulations	Defines the regulations on assigning roles to users when using LDAP authentication.

User restriction (Access control)

Access control is a function that a user authenticated by this machine can only perform permitted operations. Before using this machine, user authentication is required. The information required for user authentication is one of the following three types: user name and password, PIN (Personal Identification Number) and IC Card. To use the access control function, the administrator of this machine registers the user information, sets the authentication method, and enables access control.

For preparations before using the access control function, please refer to "[Preparations \(For the administrator\)\(P.225\)](#)".



- A card authentication kit (optional) is required to use IC card authentication.
- If the card authentication kit is not installed, "IC Card authentication is also available." will not be displayed.



- If you have been authenticated but cannot operate, check with the administrator if the operation is permitted.

Preparations (For the administrator)

Before using the access control function, the device administrator shall prepare the following on the web page of this machine.

Register a role to set which operations are permitted or prohibited.

[Registering a role](#)

There are two methods for user authentication: Local Authentication (using user information registered with this machine) and server authentication (using user information registered with the server).

If you use the local authentication method for user authentication, register users and groups.

[Registering a user](#)

[Registering a group](#)



- User registration can also be performed using the Configuration Tool.

[Registering the user name and password\(P.273\)](#)

If you use server authentication for user authentication, configure server authentication settings.

[Setting authentication server](#)

After registering users and configuring server authentication, enable the access control function.

[Enabling access control](#)

Registering a role

Register a role to assign to the user. For example, create an organizational unit name or job title role, and set and register the allowed operations (like printing) for each role.

A maximum of 100 roles can be registered. You can also assign multiple roles to a single user.

You can set to permit/prohibit the following operations for a role.

- Printing from a PC
- Printing from a USB memory

By default, two types of roles are registered.

- **.AdminRole:**
The role of the device administrator. It can be assigned to general users. A user with [.AdminRole] assigned can act as a device administrator and perform [Administrator Login] on the web page. (However, the condition is that access control is enabled and it is a local user.)
[.AdminRole] cannot be deleted or edited.
- **.DefaultRole:**
This is the role to be assigned if no role is specified when a user is registered.
[.DefaultRole] cannot be deleted, but the access rights can be edited.

1 Open the web page of this machine.

[Opening the web page](#)(P.201)

2 Log in as an administrator.

[Logging in as an administrator](#)(P.201)

3 Click [User Management].

4 Click [Role List].

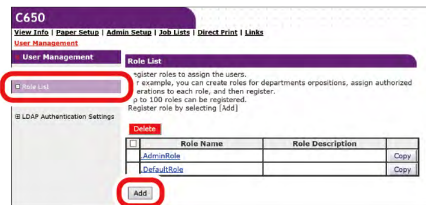

5 Click [Add].

6 When the Role Information screen is displayed, input the required information.

- **Role Name:** Input any role name. The same [Role Name] cannot be registered. Also, [Role Name] cannot be omitted.
- **Role Description:** Input a description for the role.
- **Permission:** Set permission/prohibition/forced prohibition of each operation in this role. Setting forced prohibition will prohibit operations permitted by other roles.
- **Local User List:** Add or delete a local user to which this role is assigned.
- **Kerberos User List:** Add a Kerberos user to whom this role applies.

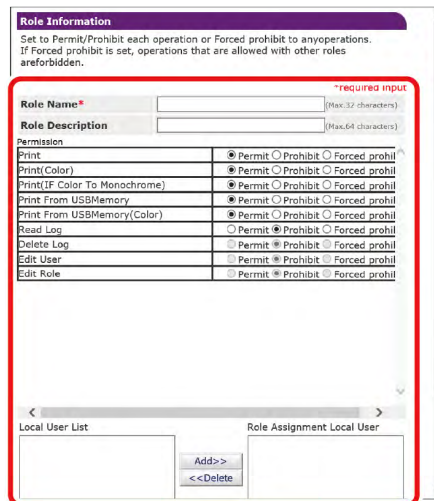

7 Click [Submit].

You can copy registered roles and add new roles based on the copied configuration.

When you click [Copy] to the right of the role name, the role information screen will be displayed, so change and register the required items.

Registering a user

When performing user authentication using the local confirmation method, register the user on this machine from the web browser. A maximum of 5,000 users can be registered.

1 Open the web page of this machine.

[Opening the web page\(P.201\)](#)

2 Log in as an administrator.

[Logging in as an administrator\(P.201\)](#)

3 Click [User Management].**4** Click [User List].**5** Set the type of user.

- Local User: Registers user information on this machine.
- LDAP User: A user registered in the LDAP server.
LDAP server authentication setting is required. LDAP user cannot be registered.
Only reference is possible. You can check the users who used this machine.
- Kerberos User: A user registered in the Kerberos server.
Kerberos server authentication setting is required. Kerberos user cannot be registered. Only reference is possible.
You can check the list of users who used this machine. You can also assign a role to a Kerberos user.

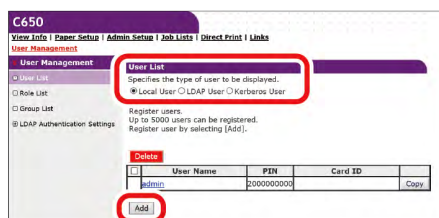
**6** Click [Add].

- 7 When the User Information Settings screen is displayed, input the required information.
- User Name: Input the user name. The same [User Name] can not be registered. Be sure to set it.
 - Password: Input the password. Be sure to set it.
 - Display Name: Input the display name.
 - E-mail address: Input the user's e-mail address.
 - Language Code: Input the language code.
 - PIN: Input the user's PIN.
 - Card ID: Input the user's IC card information.
 - Role: Set the user's role. [Role] can be assigned to multiple users.
 - Group: Set the group to which the user belongs.

- 8 Click [Submit].

You can copy registered roles and add new users based on the copied settings.

When you click [Copy] to the right of the user name, the user information screen will be displayed, so change and register the required items.

Registering a group

Users registered in this machine can be managed in a group. Up to 1,000 groups can be registered. Up to 5,000 users can be registered in one group.

- 1 Open the web page of this machine.
[Opening the web page](#)(P.201)
- 2 Log in as an administrator.
[Logging in as an administrator](#)(P.201)
- 3 Click [User Management].
- 4 Click [Group List].

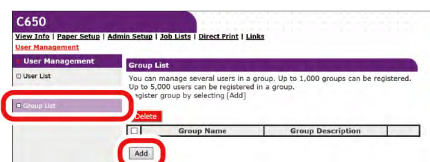

- 5 Click [+].

6 When the Group Information screen is displayed, input the required information.

- Group Name: Input any group name. Be sure to set it.
- Group Description: Input a description for the group.
- Local User List: Set the user you want to assign to this group.
- Kerberos User List: Set the Kerberos user you want to assign to this group.

7 Click [Submit].

You can copy already registered groups and add new groups based on the copied settings.

When you click [Copy] to the right of the group name, the group information screen will be displayed, so change and register the required items.

Setting authentication server

When performing user authentication using the server authentication method, set the server settings from the web browser.

Here is an example of using an LDAP authentication server.

1 Open the web page of this machine.

 [Opening the web page](#)(P.201)

2 Log in as an administrator.

 [Logging in as an administrator](#)(P.201)

3 Click [User Management].

4 Click [LDAP Authentication Settings].

5 Click [LDAP Authentication Settings].

6 Create user information based on the LDAP server information.

Input the LDAP key from which each value is obtained.

- Display name: Set the LDAP key to obtain the display name of user information.
- Mail address: Set the LDAP key to obtain the E-mail address of user information.
- Language code: Set the LDAP key to obtain the language code of user information.
- Group: Set to assign users to a group automatically. Set the LDAP key to obtain the assigned group name. When a group with a group name defined by the same text string as the acquired text exists in this machine, each group is assigned. When it does not exist, a group with the group name of acquired text string is automatically created and assigned.
- Card ID: Set the LDAP key to acquire a card ID to use for the IC card authentication. When not using IC card authentication, you do not need to input anything.
- PIN: Set the LDAP key to to acquire the PIN to use for PIN authentication. If you do not use PIN authentication, you do not need to input anything.
- User Name: Set the LDAP key of the user name registered in the LDAP server.
The default value for user name is the LDAP key "sAMAccountName" for a Windows server.
Users using a Windows server do not need to change this setting.
- Cache authentication information: Set whether authentication information is temporarily stored in this machine. The factory default setting is [Disable] (Do not save temporarily). When [Enable] is set, user authentication can be performed even when communication with the LDAP authentication server is not available due to a communication breakdown, etc., so this machine can be used continuously.
- Validity period of cache authentication information: Displayed when [Cache authentication information] is set to [Enable]. Set the validity period of the temporarily saved authentication information in this machine on a daily basis. The setting range is 1 to 2000 days. After the set number of days, authentication with temporarily stored information will not be available any more.

The screenshot shows the 'User Management' section of the C650 interface. Under 'LDAP Authentication Settings', the 'LDAP Key settings used for authentication' are configured. The 'User Name' field is set to 'sAMAccountName'. The 'Submit' button is highlighted with a red box.

7 Click [Submit].

8 Click [Role Assignment Regulations].

Define regulations for automatically assigning roles to LDAP users.

The screenshot shows the 'Role Assignment Regulations' section of the C650 interface. The 'Add' button is highlighted with a red box, and the 'Role Assignment Regulations' section is also highlighted with a red box.

9 Click [Add] to add new role assignment regulations.

- 10** When the role assignment screen is displayed, input the LDAP key, the LDAP value and the applicable role.
- When the LDAP value which is registered in the role assignment regulations of the user, and the LDAP value defined by the regulations are identified at the time of authentication, apply the role which is defined by each role assignment regulation to each user.
- When a single user matches multiple role assignment regulations, all the roles which match those regulations are applied to the user.
- 11** Click [Submit].

Enabling access control

After registering users and configuring the authentication server, enable access control.

- 1** Open the web page of this machine.
[Opening the web page\(P.201\)](#)
- 2** Log in as an administrator.
[Logging in as an administrator\(P.201\)](#)
- 3** Click [Admin Setup].
- 4** Click [Management].
- 5** Click [Access Control Setup].

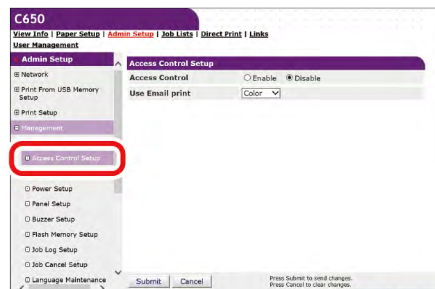

- 6** Select [Enable] in [Access Control].

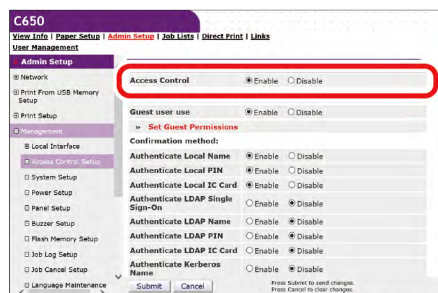

- 7** Configure access control settings according to your environment.

- Use Email print: Set to [Color], [Mono], or [Disable].

When [Color] is set, printing is performed according to the color settings of the received attached file.

When [Mono] is set, the received attached file is printed either in color or monochrome.

When [Disable] is set, the attached file received by the E-mail printing function will not be printed.

- **Guest user use:** Guest is a user assigned to those who are not successful with user authentication when the access control is enabled.
This setting is used to enable or disable the use of this machine by guest.
When [Disable] is set, you can limit the use of this machine by users who failed the user authentication. Specifically, you can disable printing by users who failed the user authentication and the operation of the operator panel.
When [Enable] is set, you can allow users who failed the user authentication to use this machine within the range of guest permissions. The definition of guest permissions can be set in the guest permission settings.
[Guest] is displayed as the authentication method on the login screen.
- **Set Guest Permissions:** The screen for setting the permissions for guest authentication is displayed. By default, guest access rights are granted for all operations. You can define guest permissions according to your security policy.
- **Authentication method:** Enable/Disable each authentication method.
A user can select the authentication method within the range granted by the administrator at the time of authentication.
If an unnecessary authentication method is disabled in this setting, the disabled authentication method will not be displayed in the user options.
- **Authentication Setting:** Set the authentication method for logging into this machine or printing.
- **Default authentication method:** Define the focused authentication method as default when the user calls the authentication screen from the operator panel.
- **Register general user's IC card:** You can set whether to allow local users who are not administrator to register their own IC cards. When enabled, any user who logged on the operator panel without using IC card can register their own IC cards via the IC card reader on this machine. An administrator can start the IC card authentication by giving the IC card to the user after he/she has received the IC card.
- **Card read settings:** Set to authenticate users with the FeliCa card.



- If you want to discard print data that cannot be authenticated, set [Guest user use] to [Disable], or set [Set Guest Permissions] to prohibit the printing permission of the guest.

8 Click [Submit].



- A card authentication kit (optional) is required to use IC card authentication. If the card authentication kit is not installed, "Auth By IC Card Avail" will not be displayed.



Logging into this machine

When access control is enabled, the home screen of this machine changes to the login screen, and user authentication is required.

This section explains the login method to this machine by authenticating a user name and password.



- Before logging in with an IC card, register the IC card information in one of the following ways.
 - Specifying IC card information when registering a user as administrator
[Registering a user\(P.227\)](#)
 - Registering by holding the card after logging in with user name and password or PIN
[Registering IC card information\(P.235\)](#)

- 1 Check that "Ready To Print" appears on the display.

 - If the machine is in the power save mode, press «POWER SAVE» to restore.
 - 2 Press the scroll button ▲ or ▼ on the operator panel to select [Local Name], and press «OK».
 - 3 Input your own user name, and press «OK».
 - 4 Input the password using the numeric keypad, and press «OK».
 - 5 Login is complete when "Ready To Print (logged in)" is displayed. The home screen is displayed.
-  You will be automatically logged out after a certain period of time without operating the panel.

Printing from a PC

If access control is enabled, when printing from a PC, input user information in the printer driver to print.

For Windows

In this example, Notepad is used to print from the PCL driver.

- 1 Select [Print] from the [File] menu.
- 2 In [Select Printer], select the required printer driver, and click [Preferences].
- 3 Select the [Extend] tab.
- 4 Click [User Authentication].

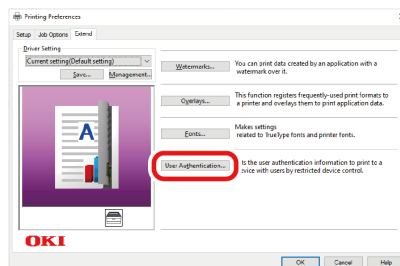

- 5 Set [User name] and [Password] of the user as user authentication information, and [Authentication Type] to specify the authentication destination and authentication mode of the user.



- [Password], [Authentication Type], and [Use User Authentication] may not be displayed in the screen depending on the setting of [User Authentication Options] in [Device Options] tab.

- 6 Check [Use User Authentication] if it is displayed.



- Uncheck [Use User Authentication] if the PIN of the job accounting client is used as user authentication information.

- 7 Input the user name and password.

The user name may be fixed as login name depending on the setting of [User Authentication Options] of the [Device Options] tab.

Check [Use logon name as user name] to use the Windows login name as the user name.

- 8** If [Authentication Type] is displayed, select the user's authentication destination and authentication mode from the list.
- Auto: Follows the method for logging into Windows. Authentication will be made by [Server LDAP] when you are logged into a domain or by [Device Local] when you are logged into a local PC.
 - Device Local: Authenticates by the user information in this machine.
 - Server LDAP: Authenticates by using LDAP in the user information of the server.
 - Server Kerberos: Authenticates by using Kerberos in the user information of the server.



- The default authentication type can be set in [User Authentication Options] of the [Device Options] tab.

- 9** Click [OK].
- 10** Specify other settings as necessary, and click [OK].
- 11** Click [Print] in the [Print] screen.

Setting details of user authentication

Set the user authentication details of the printer driver from the [Device Options] tab or [Device Settings] tab of printer properties.

- 1** Open the "Devices and Printers".
[How to open the printer folder](#)(P.142)
- 2** Right-click on the icon of [OKI C650*], and select [Printer properties].
 * Driver types (e.g. PCL6/PS)
- 3** For the Windows PCL printer driver, select the [Device Options] tab, and click [User Authentication Options]. For the Windows PS printer driver, select the [Device Settings] tab, and expand [Installable Options].
- 4** Set the details of user authentication.
- Set User Authentication Options for Each User: Displays [Use User Authentication] on the user authentication settings screen so that you can set whether to use user authentication or not.
- 
- When [Set User Authentication Options for each user] is unchecked, user authentication will be used, and authentication type will follow the method for logging into Windows. Authentication will be made by [Server LDAP] when you are logged into a domain or by [Device Local] when you are logged into a local PC.
 - To use a PIN in the pop-up mode of the job accounting client as user authentication information, check [Set User Authentication Options for each user].
- Input user authentication information when printing: Pops up user authentication settings for each print job. Use this option to specify an actual user for each print job in an environment where multiple users use the same login account on the same PC.
 This cannot be set if [Set User Authentication Options for each user] is checked.
 - Authentication Type: Sets the authentication type in user authentication settings.
 - Default Authentication Type: Specifies the default authentication type if the authentication type cannot be set.
- 5** For the Windows PCL printer driver, click [OK].
- 6** Click [OK].

For macOS

Here is an example with Text Edit.

- 1 Select [Print] from the [File] menu.
- 2 Select the printer driver for this machine.
- 3 Select [User Authentication] from the panel menu.
- 4 Check [Use User Authentication].

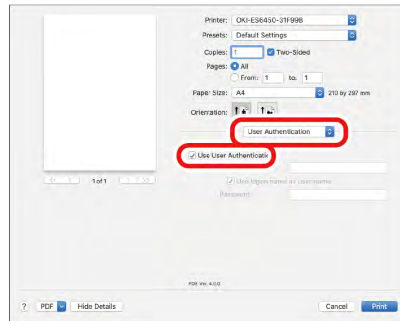

- Uncheck [Use User Authentication] if the PIN of the job accounting client is used as user authentication information.

- 5 Input [User name] and [Password].
Check [Use logon name as user name] to use the login name as the user name.
- 6 If [Authentication Type] is displayed, select the user's authentication destination and authentication mode from the list.
 - Auto: Follows the method for logging into macOS. Authentication will be made by [Server LDAP] when you are logged into to a domain or by [Device Local] when you are not logged into a domain.
 - Device Local: Authenticates by the user information in this machine.
 - Server LDAP: Authenticates by using LDAP in the user information of the server.
 - Server Kerberos: Authenticates by using Kerberos in the user information of the server.
- 7 Make settings required for printing.
- 8 Click [Print].

When using authentication type

- 1 Select [System Preferences] from the Apple menu.
- 2 Click [Printers & Scanners].
- 3 Select this machine, and click [Options and Supplies].
- 4 Check the function to be used in the [Options] tab.
- 5 Specify the default authentication type, and click [OK].

Registering IC card information

To log into this machine using an IC card, you need to register the IC card information. You can register the IC card information by yourself.



- A card authentication kit (optional) is required to use IC card authentication.

- This function is not available if you log in using any method other than local authentication.
- This function is not available when "Register general user's IC card" is set to [Disable] by the administrator.

[Enabling access control](#)(P.231)

- 1** Log into this machine using the local authentication method.
[Logging into this machine](#)(P.232)
- 2** Press the scroll button ▼ on the operator panel several times to select [User Account Info], and press «OK».
- 3** Press ▼ several times to select [Register IC card], and press «OK».
- 4** Register the IC card information by following on-screen instructions.

Initializing the settings

This section explains how to initialize the built-in memory and the settings of this machine.

Initialization is done to delete the data and settings saved in this machine and restore the machine to its initial settings.

When you forget the admin password, the settings cannot be initialized.

Initializing network settings

The network settings will return to factory defaults after initialization.



- With this operation, all network settings will be initialized.

1 Check that "Ready To Print" appears on the display.



- If the machine is in the power save mode, press «POWER SAVE» to restore.

2 Press the scroll button ▼ on the operator panel several times to select [Admin Setup], and press «OK».

3 Input the admin password using the numeric keypad, and press «OK».

[Admin password](#)(P.195)

4 Check that [Network Setup] is selected, and press «OK».

5 Check that [General Setup] is selected, and press «OK».

6 Press ▲ to select [Network Factory Defaults], and press «OK».

7 Check that [Execute] is selected, and press «OK».

8 The display will return to the standby screen.

Initializing the flash memory

The flash memory is used to store form data, etc.

Follow the procedure below to initialize it.



- Once the flash memory is initialized, the following data will be deleted.
 - Data saved by [Save as shared job] or [Private Print]
 - Form data

1 Check that "Ready To Print" appears on the display.



- If the machine is in the power save mode, press «POWER SAVE» to restore.

2 Press the scroll button ▼ on the operator panel several times to select [Admin Setup], and press «OK».

3 Input the admin password using the numeric keypad, and press «OK».

[Admin password](#)(P.195)

4 Press ▲ or ▼ several times to select [Others Setup], and press «OK».

- 5 Press ▲ to select [Flash Memory Setup], and press «OK».
- 6 Select [Initialize] or [Format Partition], and press «OK».
- 7 To initialize it, check that [Execute] is selected, and press «OK».
To format partition, select the partition to be formatted, and press «OK».



- There are two methods to initialize a memory
 - [Initialize]: Initializes the open area range (displayed in the file list) of the flash memory.
 - [Format Partition]: Initializes the user information. You can format each partition of PCL/Common/PS.

- 8 When [Are you sure?] is displayed, select [Yes] and press «OK».
To cancel the initialization, select [No] instead.

- 9 When [Execute Now?] is displayed, select [Yes] and press «OK».
This machine restarts and the memory will be initialized.



- When [Execute Now?] is displayed and you select [No], the display will return to [Flash Memory Setup], but the initialization will not be canceled. Initialization will be done the next time the power is turned on.

Initializing settings of this machine

Restores settings of this machine to the factory default settings.



- Initialization of settings of this machine will return the following data to the default factory settings.
 - [Menus] settings
 - [Admin Setup] settings
 - [Calibration] settings

- 1 Check that "Ready To Print" appears on the display.



- If the machine is in the power save mode, press «POWER SAVE» to restore.

- 2 Press the scroll button ▼ on the operator panel several times to select [Admin Setup], and press «OK».

- 3 Input the admin password using the numeric keypad, and press «OK».

[Admin password](#)(P.195)

- 4 Press ▲ several times to select [Settings], and press «OK».

- 5 Check that [Reset Settings] is selected, and press «OK».



- 6 Check that [Execute] is selected, and press «OK».

This machine restarts and the settings will be initialized.

Moving/Transporting this machine

This section describes how to move or transport this machine.

Moving this machine

 CAUTION	Doing so may cause injury.	
This machine weighs approx. 30 kg, so be sure to have it lifted by at least 2 personals.		



- 1 Power off this machine.
- 2 Remove all cables.
 - Power cord
 - LAN cable/USB cable
- 3 Remove the paper from the paper cassette.
- 4 Lift this machine and move it to the destination.



When the dedicated caster stand (optional) is installed, unlock the casters (2 places) before moving the machine.

 Do not touch the fuser unit because it is hot.

 - When the machine is moved to an uneven surface, or when the casters do not move even after you have unlocked them, remove the anti-tip feet. Refer to "[Shipping this machine\(P.239\)](#)" for the removal procedure.

Shipping this machine

 CAUTION	Doing so may cause injury.	
This machine weighs approx. 30 kg, so be sure to have it lifted by at least 2 personals.		

 CAUTION	Doing so may cause burns.	
Do not touch the fuser unit because it is hot.		

- 
- Because image drums (green parts) can easily get damaged, handle with adequate care.
 - Do not expose the image drum to direct sunlight or strong light (approx.1,500 lux or above). Do not leave it for more than 5 minutes even under room lighting.
 - Please use the packing box and buffer material at purchase of the product.

- 1 Power off this machine.
- 2 Remove all cables.
 - Power cord
 - LAN cable/USB cable
- 3 Remove the paper from the paper cassette.
- 4 Pull the front cover open lever (Blue) to open the front cover.
- 5 Take out the toner cartridge.

- 6 Put the toner cartridge into a plastic bag.
- 7 Close the front cover firmly with both hands.
- 8 If the optional expansion tray unit is installed, use a flat-head screwdriver to remove the parts (x 2) that fix this machine and the expansion tray unit.

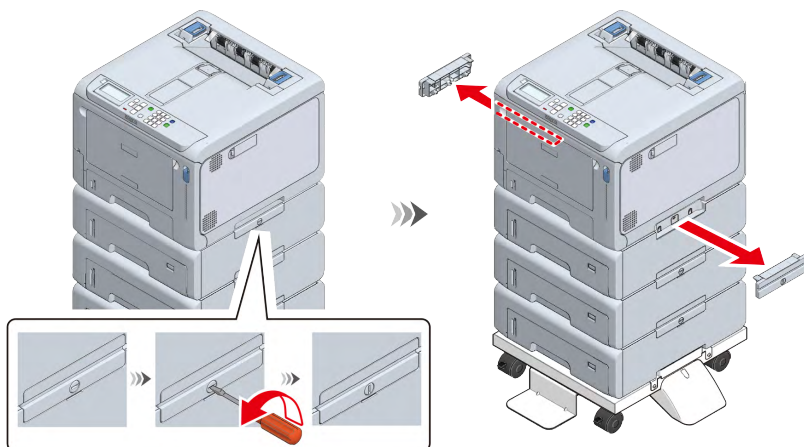

- Do not remove the parts connecting the expansion tray yet.
- Be careful not to lose the fixing parts that were removed.

- 9 Lift the machine and remove it from the expansion tray unit.



- Pack the machine and the expansion tray separately for transportation.

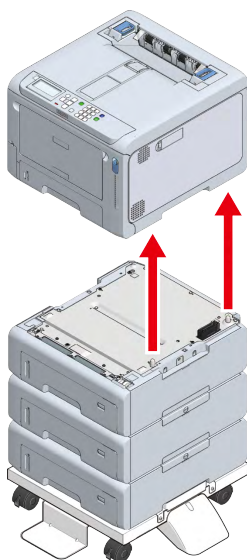

- 10 Attach the buffer material to this machine and put them together in the packing box.
- 11 Place the toner cartridge and accessories on the buffer material, close the lid of the packing box, and fix it with tape.

- 12** If there are multiple expansion tray units, use a flat-head screwdriver to remove all the fixing parts and pack them together.

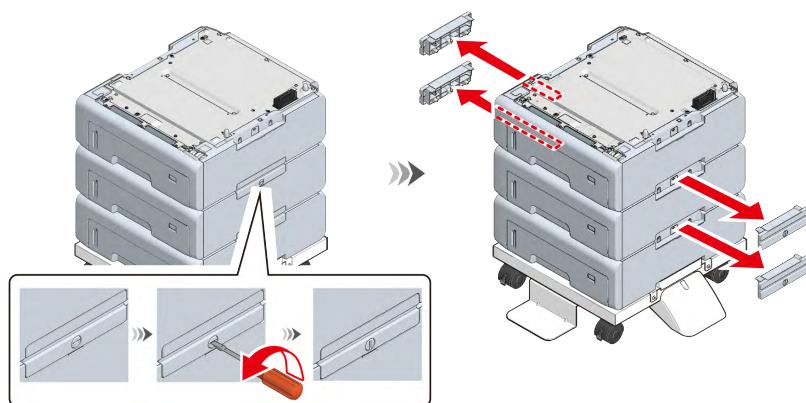

- 13** If the caster stand is installed, use a Phillips-head screwdriver to remove the metal fixtures (x 2) that fix the caster stand and the expansion tray unit.

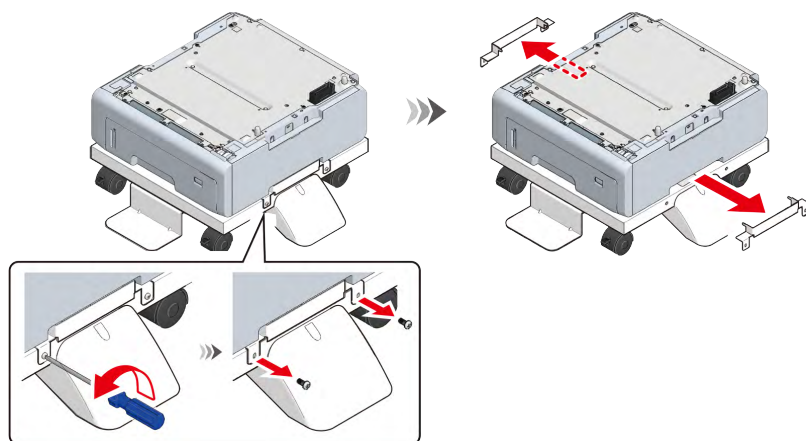

- 14** Use a flat-head screwdriver to turn the positioning pins (x 2) in the arrow direction to remove them from the caster stand.

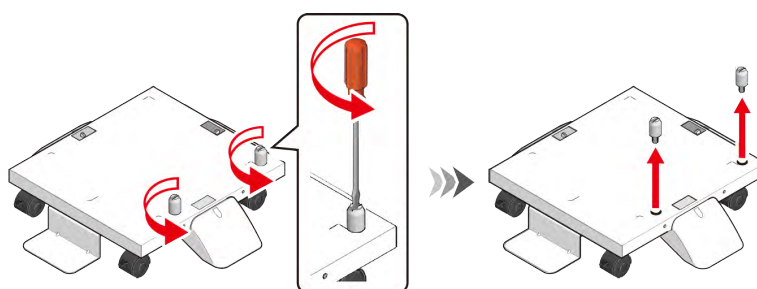

- 15** Pinch the protrusion of the anti-tip foot b through the hole on the caster stand and push it out to remove the anti-tip foot b. Follow the same procedure to remove the remaining anti-tip feet b.

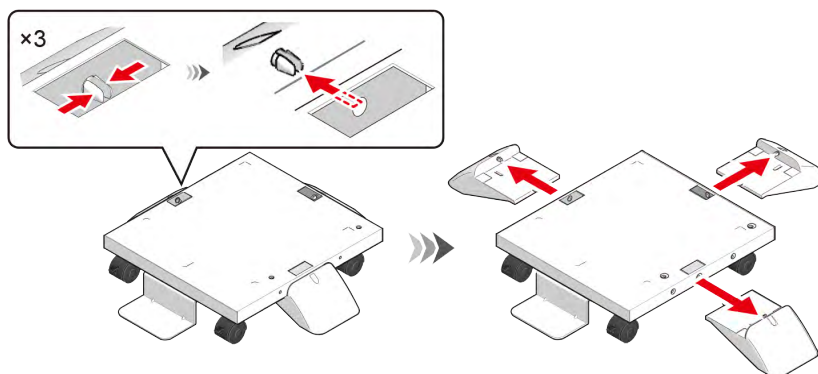

- 16** Remove the anti-tip foot a from the caster stand.

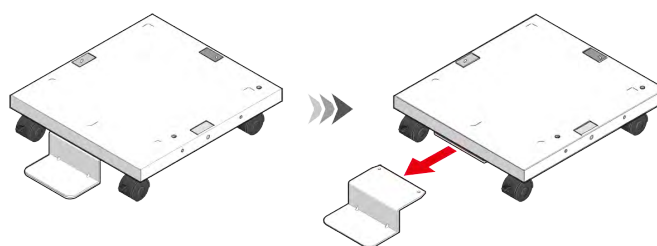

- 17** Put the caster stand in the packing box. At the same time, put the metal fixtures (x 2) of the caster stand, positioning pins (x 2), anti-tip feet b (x 3), and anti-tip foot a that were removed in Steps 13 to 16 in the packing box.



- Be careful not to lose the fixing parts that were removed.

Disposal

To dispose of this machine, it is recommended to erase the information registered or saved in this machine.

The following items are included in the information saved in this machine.

- Admin Password
- Various menu settings
- Private print data
- Various records
- Data of access control and user management (local user, external user cache [LDAP, Kerberos])

You can erase the information by the following procedure.

1 Check that "Ready To Print" appears on the display.



- If the machine is in the power save mode, press «POWER SAVE» to restore.

2 Press the scroll button ▼ on the operator panel several times to select [Admin Setup], and press «OK».

3 Input the admin password using the numeric keypad, and press «OK».

 [Admin password](#)(P.195)

4 Press ▼ several times to select [Others Setup], and press «OK».

5 Press ▼ several times to select [Erase Privacy Data], and press «OK».

6 When "Execute" is displayed, press «OK».

7 When "Are you sure?" is displayed, select [Yes] and press «OK».

8 When "Would you like really?" is displayed, select "Yes" and press «OK».

Restart the machine to erase the data.



- Once the action is executed, the erased data cannot be restored. To cancel the erasing, select [No] in Step 7.

7 Useful software

Software list.....	245
Installing software.....	247
Monitoring Tool (Windows)	249
Network Extension	255
Color Swatch Utility	257
Color Correct Utility	259
PS Gamma Adjuster.....	265
Configuration Tool.....	267
OKI LPR Utility	278
Network Card Setup Utility (macOS).....	282
Print Job Accounting Client.....	283

This section describes the software for using this machine more conveniently.

Software list

This section describes the software that can be used with this machine. Please refer to each topic for how to use the software.

Windows software

- Operating environment

Windows 10/Windows 8.1/Windows 8/Windows 7

Windows Server 2019/Windows Server 2016/Windows Server 2012 R2/Windows Server 2012

Windows Server 2008 R2/Windows Server 2008

Item	Description	Reference
Monitoring Tool	It is a tool to monitor the firmware version of the printer, software version and the service life of maintenance parts.	Monitoring Tool (Windows)(P.249)
Network Extension	You can check the settings of this machine and set options from the printer driver. This utility is installed automatically when the printer driver is installed via a network connection.	Network Extension(P.255)
Color Swatch Utility	Prints RGB color samples. You can check the RGB value for printing in the desired color from the printed color samples.	Color Swatch Utility(P.257)
Color Correct Utility	Adjusts color matching for printing from a PC. You can change the overall trend of the output colors by adjusting the output color of the palette color or by adjusting the hue and color of gamma values and primary colors.	Color Correct Utility(P.259)
PS Gamma Adjuster	You can adjust the halftone density of each CMYK color when printing from a PC. You can adjust the image color density of photos, etc.	PS Gamma Adjuster(P.265)
Configuration Tool	Configures access control settings and network settings for this machine, and registers and deletes form data, and registers and manages ICC profiles in the printer. The registered ICC profile is used for color matching in the [Graphics Pro] mode of the printer driver.	Configuration Tool(P.267)
OKI LPR utility	You can check the status of this machine connected to the network or transfer print data to another device from your PC.	OKI LPR Utility(P.278)
Print Job Accounting Client	You can set a user ID (PIN) in the printer driver to use the job accounting function or access control function of this machine.	Print Job Accounting Client(P.283)

macOS software

- Operating environment

macOS 10.15 - 10.12, OS X 10.11

Item	Description	Reference
PS Gamma Adjuster	You can adjust the halftone density of each CMYK color when printing from a PC. You can adjust the image color density of photos, etc.	PS Gamma Adjuster(P.265)
Color Correct Utility	Adjusts color matching for printing from a PC. You can change the overall trend of the output colors by adjusting the output color of the palette color or by adjusting the hue and color of gamma values and primary colors.	Color Correct Utility(P.259)

Item	Description	Reference
Network Card Setup Utility	Enables you to make network settings.	Network Card Setup Utility (macOS) (P.282)
Profile Assistant	Registers and manages the ICC profile in the printer. The registered ICC profile is used for color matching in the [Graphics Pro] mode of the printer driver.	Download from the website.
Print Job Accounting Client	You can set a user ID (PIN) in the printer driver to use the job accounting function or access control function of this machine.	Print Job Accounting Client (P.283)

Applications for mobile devices

Item	Description	Reference
Mobile Print	You can print web pages or photos with an OKI LED printer or LED MFP connected to a network via a wireless LAN from your smartphone, tablet or other mobile devices. (For Android/iOS)	Using the Mobile Print (P.287)
NFC Setting Tool	You can restore the default settings of this machine from a smartphone by using the NFC function even when the power of this machine is off. (For Android only)	For details, please refer to the "Online Manual" on the website.

Installing software

Follow the procedure below to install the software you want to use.

If your PC does not come with a DVD drive, or if you want to update the software, download and install it from the website.

For Windows

Install the software that you want to use with the included DVD.

Connect this machine to a PC with a network or USB cable, and start the installation.



- Check the status of this machine before installation.
 - The power is turned on.
 - For connection with a network, the machine is connected to a network with a network cable and the IP address and other settings of the machine have been configured.

- 1 Insert the included DVD to the PC.
- 2 When [Auto Play] is displayed, click [Launch Setup.exe].

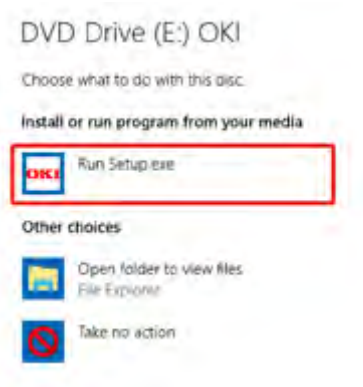

- When the [User Account Control] screen is displayed, click [Yes].

- 3 Choose a language from the pull-down menu of language selection in the [Welcome] screen.
- 4 Read the software license agreement, and click [Accept].
- 5 Read the environmental advice, and click [Go].
- 6 Click either [Network Connection] or [USB Connection] depending on the connection method between the PC and this machine.
If [Windows Security Alert] screen is displayed, click [Allow Access].
- 7 Select the model name of this machine, and click [Go].

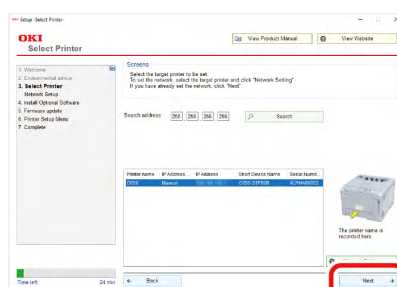

8 Click [Individual Install].

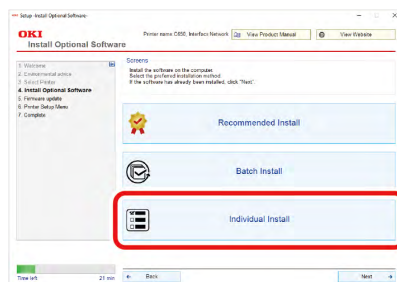

9 Click the driver or software you want to install.

Installation will begin.



- The procedure below may vary with the selected software. This is an example of installing the Configuration Tool.

10 Click [Next] to start the installation.

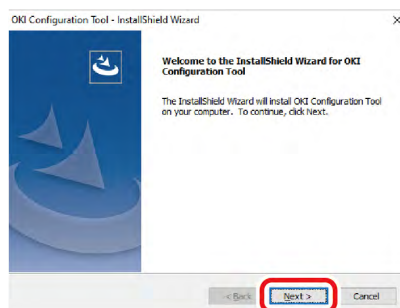

The installation starts.

11 When the installation is complete, click [Finish].

For macOS

Drag and drop to copy it to the place you want. You can also start directly from the provided DVD.

- 1 Insert the included DVD to the PC.
- 2 Double-click on [OKI] - [Utility] folder.
- 3 Drag and drop to copy the software folder you want to install to the place you want.



- Double-click on the software icon in the folder to launch it.

For mobile devices

Download Mobile Print from App Store or Google Play Store.



- The Android version can also be downloaded from the website.

The NFC Setting Tool can be downloaded from the website.
For details, please refer to the "Online Manual" on the website.

Monitoring Tool (Windows)

You can manage the firmware and software updating of the printer and the replacement period of maintenance parts with the Monitoring Tool.

The Monitoring Tool is available only for Windows.

To learn how to install the Monitoring Tool, see "[Installing software\(P.247\)](#)".



- You can also automatically manage the firmware updating of the printer and the replacement period of maintenance parts.
When using the automatic management function, use the same Windows login user when installing the Monitoring Tool and when using the Monitoring Tool.

Registering the printer

Register the printer to be monitored with the Monitoring Tool.

- Select [Start] - [Okidata] - [Monitoring Tool] to start the Monitoring Tool.
- Select [Register printer] from the [Settings] menu.

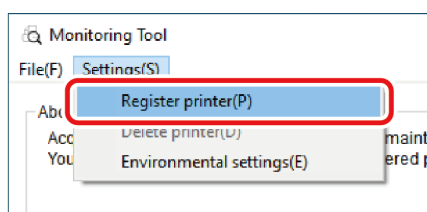

- Select the printer to be registered from the printer list, and click [Register].

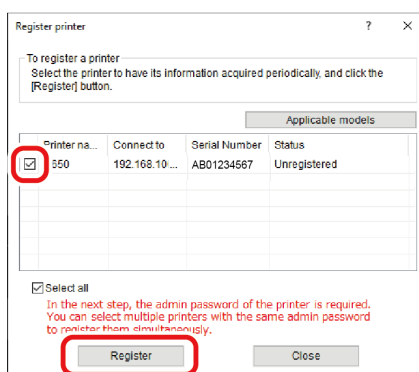

- Input the admin password of the printer, and click [OK].

[Admin password\(P.195\)](#)

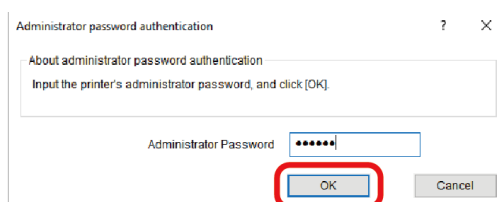

- If an admin password authentication error is displayed, the admin password you input may be incorrect. Input the correct admin password again.

5 Click [Close].

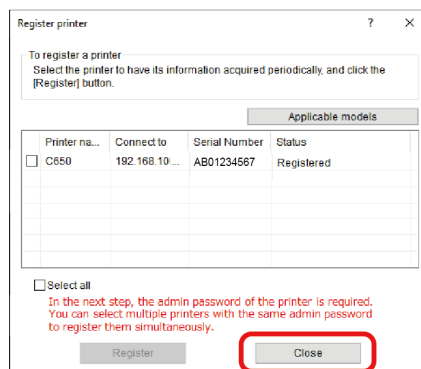

6 Check that the registered printer is displayed.

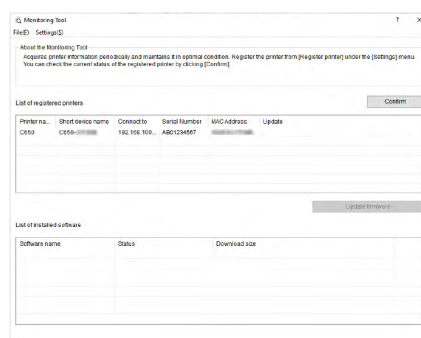

Updating the printer software

Monitoring Tool checks the status of this machine periodically. When software update is available for this machine, follow the on-screen instructions to update the software.

1 When update is available for software, [Update Recommended] is displayed in the [Status] field.

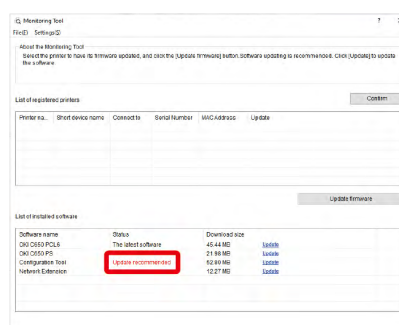

2 Click [Update] on the line where [Update Recommended] is displayed.

3 Click [Agree] on the license agreement display.

4 Follow the on-screen instructions as installation begins.



- The screen may vary with the software.

5 When the installation is complete, click [Quit].

- 6 Check that [The latest software] is displayed in the [Status] field.

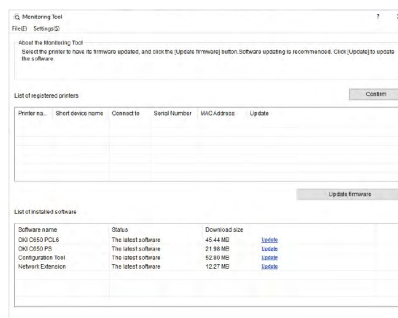

- 7 Select [Quit] from the [File] menu.

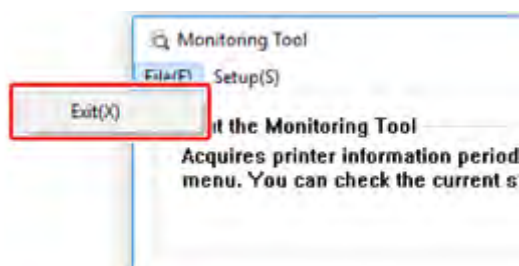

Updating the printer's firmware

Monitoring Tool checks the status of this machine periodically. When firmware update is available for this machine, follow the on-screen instructions to update the firmware.

- 1 When firmware update is available for this machine, [Update Recommended] is displayed in the update field.

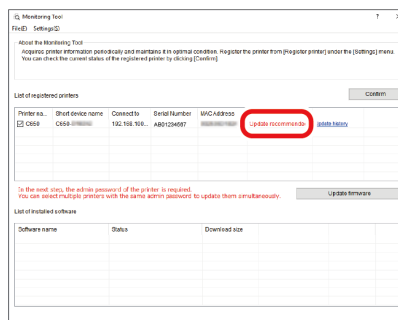

- 2 Check the name of this machine, and click [Update firmware].
- 3 On the [Administrator password authentication] screen, input the admin password of this machine, and click [OK].

[Admin password\(P.195\)](#)

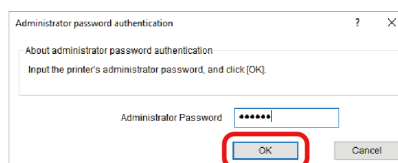

- 4 The latest firmware is downloaded from the website, and the printer firmware is updated.



- Do not turn off the printer while updating the firmware.

- 5 When [Completed] is displayed and "Success" is displayed in the [Status] field, the firmware update is completed.



- If failed, an error message will be displayed in the [Status] field. Click [Details] on the right side of the message to display the error correction method.

- 6 Select [Quit] from the [File] menu.

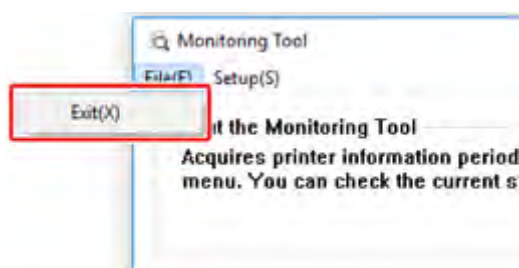

Changing settings of Monitoring Tool

- 1 Select [Start] - [Okidata] - [Monitoring Tool] to start the Monitoring Tool.
- 2 Select [Environmental settings] from the [Settings] menu.

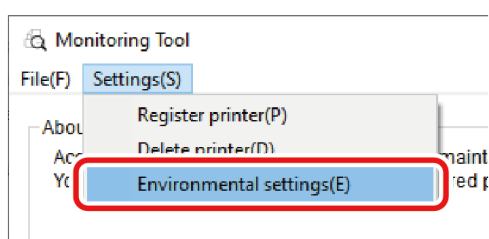

- 3 Set the values in each tab, and click [Apply].
 - [Printer Communication] tab

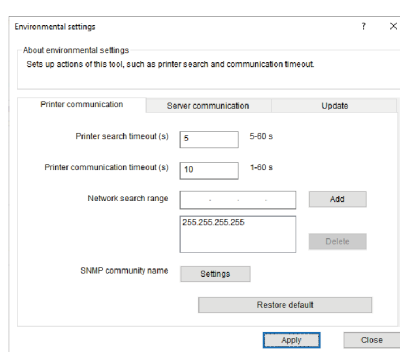

Item	Description
Printer Search Timeout	Sets the time for searching for the printer.
Printer Communication Timeout	Sets the time limit for the timeout error of connection to the printer.
Network Search Range	Specifies the range for searching for the printer.
SNMP Community Name	Sets the SNMP community name.
Restore default	Returns all settings to default values.

- [Server Communication] tab

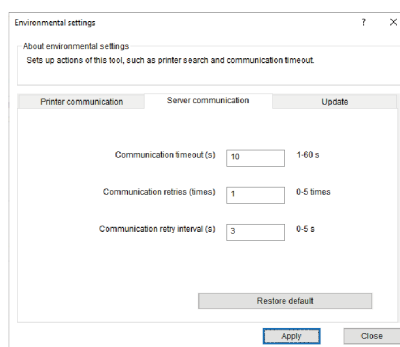

Item	Description
Communication timeout (s)	Sets the timeout time for communication with the website.
Communication retries (times)	Sets the number of retries when an error has occurred to communication with the website.
Communication retry interval (s)	Sets the interval for retrying communication with the website.
Restore default	Returns all settings to default values.

- [Firmware Update] tab

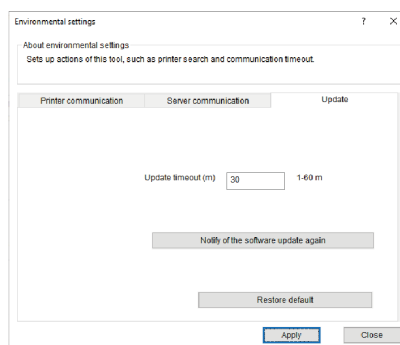

Item	Description
Update timeout (m)	Sets the timeout limit for the firmware update.
Restore default	Returns all settings to default values.

Deleting the printer

Delete a printer registered with the Monitoring Tool.

- 1 Select [Start] - [Okidata] - [Monitoring Tool] to start the Monitoring Tool.
- 2 Select [Delete printer] from the [Settings] menu.

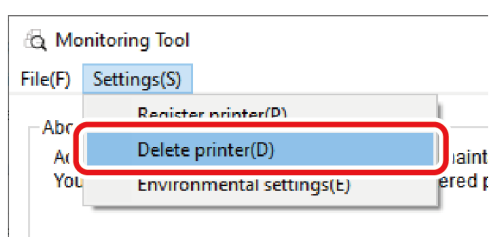

3 Check the printer to be deleted, and click [Delete].

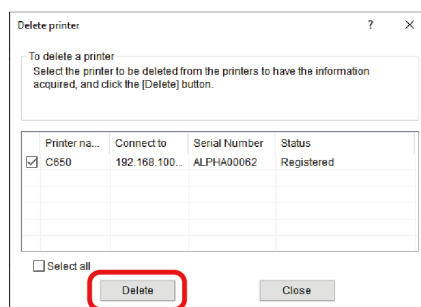

Troubleshooting (Monitoring Tool)



- Please check the following explanation and "Frequently Asked Questions (FAQs)" on your smartphone app or the website.
- If the problem persists, contact your dealer.
- For problems arising from the application, contact the application development company.

When firmware update has failed

Cause	Solution	Reference
The connection with the server has failed.	Check your Internet connection environment.	-
The admin password that you input is incorrect.	Check the admin password.	-
The printer is powered on.	Power on the printer, enter the standby mode, and run the update again.	-
The printer is not connected.	Connect the printer.	-
The printer is being used.	Update the firmware after the printer has stopped.	-
An error occurred in the printer (No toner, paper jam, etc.).	Update the firmware after the error has been cleared.	-

When driver installation or update has failed in Windows 7/Server 2008/Server 2008 R2

Cause	Solution	Reference
Microsoft update "KB4474419" is not applied.	Please apply Microsoft update "KB4474419". For details, check the "Frequently Asked Questions (FAQs)" on the website.	Website

Network Extension

With Network Extension, you can check the settings of this machine and set optional configurations.

TCP/IP must be enabled to use Network Extension.



- Administrator privileges are required.



- Network Extension is automatically installed when the printer driver is installed in a TCP/IP network.
- Network Extension works in conjunction with the printer driver. Do not install Network Extension only.
- Network Extension works only when the printer driver is connected to the OKI LPR port or standard TCP/IP port.

Displaying properties of the printer driver

To use Network Extension, display the [Printer Properties] screen.

- 1 Open the "Devices and Printers".
[How to open the printer folder\(P.142\)](#)
- 2 Right-click on the printer icon, and select [Printer properties].

Confirming settings of this machine

You can check the settings of this machine from the [Printer Properties] screen.

- 1 Display the [Printer Properties] screen.
[Displaying properties of the printer driver\(P.255\)](#)
- 2 Select the [Status] tab.

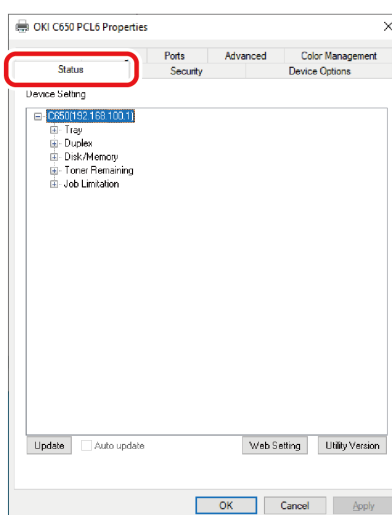

- 3 Click [Update].
- 4 Click [OK].

Click [Web Setting] to start the web page automatically. You can change the settings of this machine on the web page screen.

- [Web page \(Managing this machine from a PC\)\(P.201\)](#)



- If Network Extension is used in an unsupported environment, the [Status] tab may not be displayed.

Setting options automatically

You can acquire the optional configurations of this machine connected to the network, and automatically set the printer driver.

For Windows PCL printer driver

- 1 Display the [Printer Properties] screen.
[Displaying properties of the printer driver\(P.255\)](#)
- 2 Select the [Device Options] tab.
- 3 Click [Get Printer Settings].
- 4 Click [OK].

For Windows PS printer driver

- 1 Display the [Printer Properties] screen.
[Displaying properties of the printer driver\(P.255\)](#)
- 2 Select the [Device Settings] tab.
- 3 Click [Get installed options automatically], and click [Setup].
- 4 Click [OK].



- Setting is not possible when Network Extension is used in an unsupported environment.

Uninstalling Network Extension

- 1 Click [Start], and select [Windows System Tools] - [Control Panel] - [Programs and Features].
- 2 Select [OKI Network Extension], and click [Uninstall].
- 3 Finish the uninstallation by following the on-screen instructions.

Color Swatch Utility

You can print RGB color samples using the Color Swatch Utility. By checking the printed color sample and adjusting the RGB value as needed, you can print your desired colors from the application.



- It is not applicable to macOS.



- The Color Swatch Utility is installed automatically when the printer driver is installed.

Printing a color sample

- 1 Click [Start], and select [Okidata] - [Color Swatch Utility].

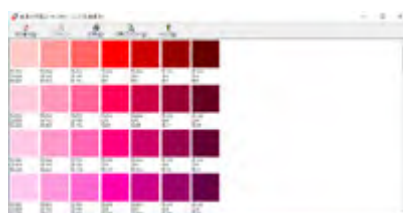

- 2 Click [Print].
- 3 Select the device you want to adjust from [Name].
- 4 Click [OK].
- 5 Confirm the color you want to print from the color sample, and write down the RGB value.

Customizing the color sample

If you cannot find the color you want to print in Step 5 of "[Printing a color sample\(P.257\)](#)", follow the procedure below to customize the color.

- 1 Click [Switch].
- 2 Click [Detail].
- 3 Adjust the three slide bars until the color you want is displayed.
- 4 Click [Close].
- 5 Click [Print].
- 6 Select this machine from [Name].
- 7 Click [OK].
- 8 Check that the color is adjusted as you wish.



- If you are not satisfied with the result, repeat Steps 1 to 8.

Printing a file in your desired color

- 1 Open the file to be printed.
- 2 Select the text or graphic, and adjust the RGB values from the application.
- 3 Print the file.



- Read the User's Manual of the application for instructions on how to specify the color in the application.
- To print a file to the same result with the color sample, use the same printer driver settings.

Color Correct Utility

This section explains how to adjust the color using the Color Correct Utility.



- Set up each printer driver.
- To use the Color Correct Utility, you will have to login to the PC as a user with administrator privileges.

Changing palette colors

You can use the Color Correct Utility to specify colors of the palette selected in software like Microsoft Excel.

For Windows

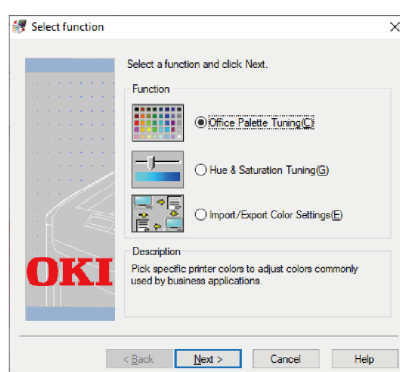

- 1 Click [Start] and select [Okidata] - [Color Correct Utility].
- 2 Select [Office Palette Tuning], and click [Next]. and click [Next].
- 3 Select the device to be adjusted, and click [Next].
- 4 Select the name of the setting, and click [Print Sample].



- If the settings are initialized after the printer driver has been updated and reinstalled, start the Color Correct Utility to automatically reset the name of the color tuning.
Check that the color tuning name is displayed on the [Select setting] screen.

- 5 Click [Next].
- 6 Click [Print Test].
- 7 Compare the color palette on the screen with the colors of the printed color sample for adjustment.
The color marked with an x cannot be adjusted.
- 8 Click the color you want to adjust.
- 9 Check the adjustable range of X and Y from the drop-down list.
The adjustable value varies with the specific color.
- 10 Check the printed color samples, select the most suitable color within the adjustable range, and then check the X and Y values.
- 11 Select the values you checked in Step 10, and click [OK].

- 12 Click [Print Test] to check whether the adjusted color is closer to the color you want, and then click [Next].
If you want to further change the color or change other colors, repeat Steps 8 to 11.
- 13 Input a name for the setting, and click [Save].
- 14 Click [OK].
- 15 Click [Finish].

For macOS

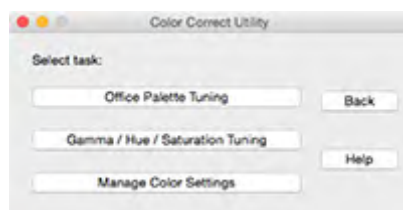

- 1 Start the Color Correct Utility.
- 2 Select the device you want to adjust.
- 3 Click [Next].
- 4 Click [Office Palette Tuning].
- 5 Select the name of the setting, and click [Print Sample].
- 6 Click [Next].
- 7 Click [Print Test].
- 8 Compare the color palette on the screen with the colors of the printed color sample for adjustment.
The color marked with an x cannot be adjusted.
- 9 Click the color you want to adjust.
- 10 Check the adjustable range of X and Y from the pull-down menu.
The adjustable value varies with the specific color.
- 11 Check the printed color samples, select the most suitable color within the adjustable range, and then check the X and Y values.
- 12 Select the values you checked in Step 11, and click [OK].
- 13 Click [Print Test] to check whether the adjusted color is closer to what you want.
If you want to further change the color or change other colors, repeat Steps 9 to 13.
- 14 Input a name and click [Save].
- 15 Select [Printers & Scanners] from [System Preferences], delete the registered adjusted device, and then re-register.

Changing gamma values and hues

The tone can be adjusted by adjusting the gamma value, and the output color can be adjusted by adjusting the hue.

For Windows

- 1 Click [Start] and select [Okidata] - [Color Correct Utility].
- 2 Select [Hue & Saturation Tuning], and click [Next].
- 3 Select the device to be adjusted, and click [Next].
- 4 Select the standard mode, and click [Next].
 - ⓘ
 - If the settings are initialized after the printer driver has been updated and reinstalled, start the Color Correct Utility to automatically reset the name of the color tuning.
Check that the color tuning name is displayed on the [Select setting] screen.
- 5 If necessary, make settings by adjusting the slide bar.
If [Use printer's unadjusted color.] is checked, 100 percent of each color is used for printing, and the slide bar of hue is fixed.
- 6 Click [Print Test].
- 7 Check the printed results.
If the desired results have not been obtained, repeat Steps 5 to 7.
- 8 Click [Next].
- 9 Input a name and click [Save].
- 10 Click [OK].
- 11 Click [Finish].

For macOS

- 1 Start the Color Correct Utility.
- 2 Select the device you want to adjust.
- 3 Click [Next].
- 4 Click [Hue & Saturation Tuning].
- 5 Select the standard mode, and click [Next].
- 6 If necessary, make settings by adjusting the slide bar.
If [Use printer's unadjusted color.] is checked, 100 percent of each color is used for printing, and the slide bar of hue is fixed.
- 7 Click [Print Test].
- 8 Check the printed results.
If the desired results have not been obtained, repeat Steps 6 to 8.
- 9 Input a name and click [Save].
- 10 Select [Printers & Scanners] from [System Preferences], delete the registered adjusted device, and then re-register.

Printing with tuned color settings

For Windows PCL printer driver

- 1 Open the file to be printed.
- 2 Select [Print] from the [File] menu.
- 3 Click [Preferences].
- 4 Click [Detail] in [Setup], and select [Office Color].
- 5 Check [Color Correct Utility Settings], select settings created with the Color Correct Utility, and click [OK].

For Windows PS printer driver

- 1 Open the file to be printed.
- 2 Select [Print] from the [File] menu.
- 3 Click [Preferences].
- 4 Select the [Color] tab, select [Office Color], and then click [Options].
- 5 Check [Color Correct Utility Settings], and then select the settings created using the Color Correct Utility, and click [OK].

For macOS

- 1 Open the file to be printed.
- 2 Select [Print] from the [File] menu.
- 3 Select [Office Color] in the [Color] panel.
- 4 Select the settings created using the Color Correct Utility from [User Color].

Saving color tuning settings

You can save the tuned color settings.



- To use this function, you will have to log into the PC as a user with administrator privileges.

For Windows

- 1 Click [Start] and select [Okidata] - [Color Correct Utility].
- 2 Select [Import/Export Color Settings], and click [Next].
- 3 Select the device where you want to save the settings, and click [Next].
- 4 Click [Export].
- 5 Select the settings to be exported, and click [Export].
- 6 Specify the file name and the destination folder, and click [Save].
- 7 Click [OK].
- 8 Click [Finish].

For macOS

- 1 Start the Color Correct Utility.
- 2 Select the device where you want to save the settings.
- 3 Click [Next].
- 4 Click [Import/Export Color Settings].
- 5 Click [Export].
- 6 Select the settings to be exported, and click [Export].
- 7 Specify the file name and the destination folder, and click [Save].
- 8 Click [Cancel].
- 9 Click [Finish].
- 10 Click [OK] on the confirmation screen.

Importing color tuning settings**For Windows**

- 1 Click [Start] and select [Okidata] - [Color Correct Utility].
- 2 Select [Import/Export Color Settings] , and click [Next].
- 3 Select the device into which you want to import settings, and click [Next].
- 4 Click [Import].
- 5 Select the file and click [Open].
- 6 Select the settings that you want to import, and click [Import].
- 7 Check that the settings are correctly imported, and click [Finish].

For macOS

- 1 Start the Color Correct Utility.
- 2 Select the device into which you want to import settings.
- 3 Click [Next].
- 4 Click [Import/Export Color Settings].
- 5 Click [Import].
- 6 Select the folder into which the settings to be imported are saved, and click [Open].
- 7 Select the settings that you want to import, and click [Import].
- 8 Click [Cancel].
- 9 Confirm that the settings are correctly imported, and then exit the Color Correct Utility.

Deleting color tuning settings**For Windows**

- 1 Click [Start] and select [Okidata] - [Color Correct Utility].

- 2 Select [Import/Export Color Settings] , and click [Next].
- 3 Select the device from which you want to delete the settings, and click [Next].
- 4 Select the settings to be deleted, and click [Delete].
- 5 Click [Yes] on the confirmation screen.
- 6 Check that the settings have been deleted correctly, and click [Finish].

For macOS

- 1 Start the Color Correct Utility.
- 2 Select the device from which you want to delete the settings.
- 3 Click [Next].
- 4 Click [Import/Export Color Settings].
- 5 Select the settings to be deleted, and click [Delete].
- 6 Click [Yes] on the confirmation screen.
- 7 Check that the settings are deleted correctly, and click [Finish].
- 8 Click [OK] on the confirmation screen.

PS Gamma Adjuster

You can adjust the halftone density of each CMYK color for this machine. Make adjustments if an image like a photo is too dark.



- For Windows, the [Custom Gamma Adjustment] menu or its content may not be displayed on the [Color] tab of the printer driver after a name is registered in [Gamma Curve Name]. In such a case, restart your PC.
- Using the Gamma Adjuster may slow down the printing. If you want to prioritize the speed, uncheck [Custom Gamma Adjustment] in the [Color] tab of the printer driver for Windows. For macOS, select [Not Specified] for [Custom Gamma Adjustment] in the [Quality 2] tab on the [Print Options] panel.
- Applications that have been started before registering [Gamma Curve Name] must be restarted before printing.
- Some applications allow you to specify dot gain correction and gamma adjustment when printing or include this setting in an EPS file. To use the functions provided by an application, uncheck [Custom Gamma Adjustment] in the [Color] tab of the printer driver for Windows. For macOS, select [Not specified] for [Custom Gamma Adjustment] in the [Quality 2] tab on the [Print Options] panel.
- For Windows, the model name is displayed in the "Select Printer" list of the PS Gamma Adjuster. If multiple identical models exist in the "Devices and Printers", the registered [Gamma Curve Name] is valid for all identical models.

Registering a gamma adjuster name

For Windows PS printer driver

- 1 Click [Start], and select [Okidata] - [PS Gamma Adjuster].
- 2 Select [OKI C650 PS] from [Select Printer].
- 3 Click [New].
- 4 Adjust the halftone.
Adjust the halftone by editing the graph or inputting the gamma value and tone density in the text box.
- 5 Input the setting name in [Gamma Curve Name], and click [OK].
- 6 Click [Add].
- 7 Click [Apply].
- 8 Click [OK].
- 9 Click [Exit] to close the PS Gamma Adjuster.

For macOS

- 1 Start the PS Gamma Adjuster.
- 2 Click [Edit Gamma Curve].
- 3 Adjust the halftone.
Adjust the halftone by editing the graph or inputting the gamma value and tone density in the text box.
- 4 Input the setting name in [Gamma Curve Name], and click [Save].
- 5 Click [Select PPD File].
- 6 Select a PPD file, and click [Open].
- 7 Select the gamma adjuster you created, and click [Add].
- 8 Click [Save].
- 9 Select [Printers & Scanners] in [System Preferences].

- 10 Delete the registered device to which the adjustment has been set, and then register it again.



- Do not click the [Config] button displayed while adding the printer.
- If a dialog box for selecting a printer option is displayed while adding a printer, click [Cancel] and then add the printer again.

Printing with registered halftone

For Windows PS printer driver

- 1 Open the file to be printed.
- 2 Select [Print] from the [File] menu.
- 3 Click [Preferences].
- 4 Check [Custom Gamma Adjustment] in the [Color] tab.
- 5 Select the registered halftone adjuster name.
- 6 Specify other menus as necessary, and click [OK].
- 7 Click [Print] in the [Print] screen.

For macOS

- 1 Open the file to be printed.
- 2 Select [Print] from the [File] menu.
- 3 Select the [Print Options] panel.
- 4 Select the registered halftone adjuster name from [Custom Gamma Adjustment] of the [Quality2] tab.
- 5 Specify other settings as necessary, and click [Print].

Configuration Tool

The Configuration Tool allows you to manage multiple machines and change their settings.

Registering this machine

Register this machine with the Configuration Tool when installing it for the first time.

- 1 Click [Start] and select [Okidata] - [Configuration Tool].
- 2 Select [Register Device] from the [Tools] menu.

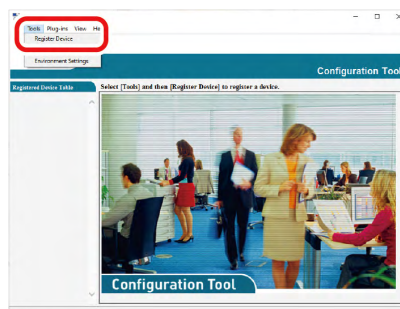

- 3 When registrable devices are displayed, select this machine, and click [Register].
- 4 Click [Yes] on the confirmation screen.

Starting the Configuration Tool

- 1 Click [Start] and select [Okidata] - [Configuration Tool].
- 2 Select this machine from [Registered Device Table].

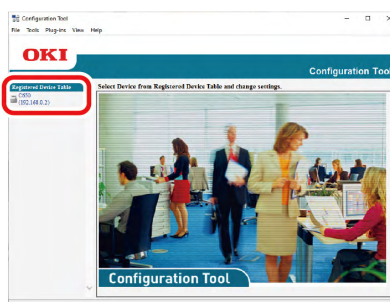

Checking the state of this machine

You can check the state and information of this machine.

- 1 Click [Start] and select [Okidata] - [Configuration Tool].
- 2 Select this machine from [Registered Device Table].
- 3 Select the [Device Info] tab.



- When this machine is connected to a network, [Device Status] is displayed.
- To update the information, click [Update Device Information].

Displaying job completion on the PC



- The time and time zone of this machine must be consistent with your PC.

Setup

- 1 Click [Start] and select [Okidata] - [Configuration Tool].
- 2 Select [Alert Info] from the [Plug-in] menu.

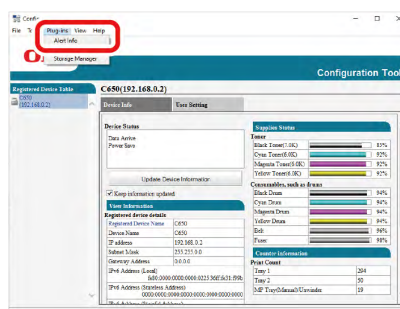

- 3 Select [Basic settings].

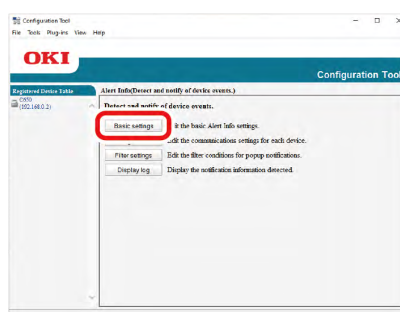

- 4 Change the settings as necessary.
- 5 Click [Update].

Device Settings

- 1 Click [Start] and select [Okidata] - [Configuration Tool].
- 2 Select [Alert Info] from the [Plug-in] menu.
- 3 Select [Setting devices].

- 4 Click [Update device].

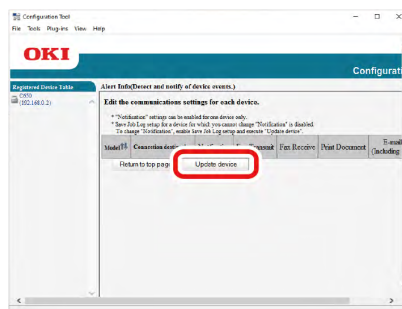

- 5 Click the device name you want to set.
- 6 Change the settings as necessary, and click [OK].

Filter Settings

You can set alert conditions to be displayed when an e-mail is received during printing.

- 1 Click [Start] and select [Okidata] - [Configuration Tool].
- 2 Select [Alert Info] from the [Plug-in] menu.
- 3 Select [Filter settings].

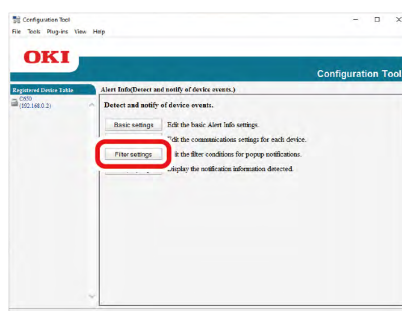

- 4 Change the settings as necessary.

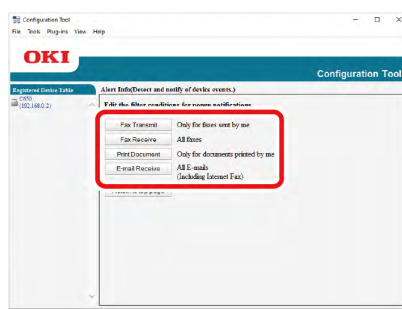

- 5 Click [OK].



- Up to 100 senders can be registered as e-mail senders.

Checking logs

From the event log, you can check whether there are any records for this registered machine.

- 1 Click [Start] and select [Okidata] - [Configuration Tool].
- 2 Select [Alert Info] from the [Plug-in] menu.
- 3 Select [Display log].
- 4 Select [Devices displaying log].

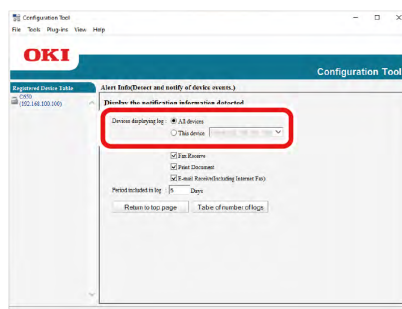

- You can check the total number of recorded events in [Table of number of logs].
- You can check the details of recorded logs in [Log details].

Setting the network

Searching for this machine on the network

- 1 Click [Start] and select [Okidata] - [Configuration Tool].
- 2 Select [Network Setting] from the [Plug-in] menu.
- 3 Select [Discover Devices].
- 4 Search results will be displayed.

Specifying search conditions

- 1 Click [Start] and select [Okidata] - [Configuration Tool].
- 2 Select [Network Setting] from the [Plug-in] menu.
- 3 Select [Environment Settings].
- 4 Specify the search conditions as necessary, and click [OK].

Changing the IP address

You can change the IP address of this machine.

- 1 Click [Start] and select [Okidata] - [Configuration Tool].
- 2 Select [Network Setting] from the [Plug-in] menu.
- 3 Select [Discover Devices].
- 4 Select this machine from the device list.
- 5 Click the [Setting devices] icon.

6 Input the IP address.

Network Setting

IP Acquisition Method

Manual
 Auto
 DHCP/BOOTP

Details

Please enter the IP address, subnet mask and default gateway address.

IP Address	192	.	168	.	0	.	2
Subnet Mask	255	.	255	.	0	.	0
Default Gateway Address	0	.	0	.	0	.	0

OK Cancel

7 Click [Set].

8 Input the admin password, and click [OK].

[Admin password\(P.195\)](#)

9 Click [OK] to restart the machine.

Registering ICC profiles

You can register and edit printer profiles in this machine. This section explains how to register ICC profiles.

1 Click [Start] and select [Okidata] - [Configuration Tool].

2 Select [Storage Manager] from the [Plug-in] menu.

3 Click the [New Project] icon.

4 Click the [Add File to Project] icon, and change [FILE TYPE] "Color matching file(*.ICC,*.ICM)" in the [Open File] menu.

5 Select the profile to be registered, and click [Open].

6 From [FILE TYPE], select the type of the profile you want to register.

7 Click [Component] in the ICC profile added to the project to display the [Edit File] dialog box.

8 Select the number you want to register.

The numbers already used in the project cannot be selected, and they are highlighted in yellow.

9 If necessary, input a comment in the [Comment] field.

10 Click [OK] to apply the changes.

11 Select this machine in the window at the bottom of the Storage Manager plug-in screen.

12 Click the [Send project files to printer] icon.

13 Click [OK].

Registering forms (form overlay)

You can register a logo, etc., as a form file in this machine for overlay printing. This section explains how to register a form file.

How to print in overlay

[Printing overlaid text or logos \(overlay printing\)\(P.157\)](#)



- To use the Windows PS printer driver, administrator privileges are required.
- To use the Windows PCL printer driver, see "[Printing overlaid text or logos \(overlay printing\)](#)(P.157)".

Creating a form file

- 1 Open the "Devices and Printers".
[How to open the printer folder](#)(P.142)
- 2 Right-click on the icon of this machine, and select the required printer driver from [Printer Properties].
- 3 Select the [Port] tab, check [FILE:] from [Printing Port], and click [Apply].
- 4 Create a form to be registered with this machine.
- 5 Select [Print] from the [File] menu.
- 6 Printing starts.
- 7 Input a name for the file to be saved.
 Example: C:\temp\form.prn
- 8 Select the original port from [Printing Port] on the [Port] tab, and click [OK].

Registering a form with this machine using Configuration Tool

- 1 Click [Start] and select [Okidata] - [Configuration Tool].
- 2 Select [Storage Manager] from the [Plug-in] menu.
- 3 Click the [New Project] icon.
- 4 Click the [Add File to Project] icon, and select the created form file.
 The form will be added to the project.
- 5 Click the form file.
- 6 Select this machine in the window at the bottom of the Storage Manager plug-in screen.

 - When this machine is not registered with the Configuration Tool, see "[Registering this machine](#)(P.267)" to register it.
- 7 Click the [Send project files to printer] icon.
- 8 Click [OK].

Checking free space of memory/hard disk

- 1 Click [Start] and select [Okidata] - [Configuration Tool].
- 2 Select [Storage Manager] from the [Plug-in] menu.
- 3 Click the device name from the device selection area below the Storage Manager plug-in screen.
 Display the storage, volume name, size, free space, location name, label, status, file name, size, comments, etc. by communicating with the device.

Registering the user name and password

You can use the user name and password to restrict access to this machine.

The changed settings are reflected in this machine when the [Save to device] icon is clicked.

Creating a new user

1 Click [Start] and select [Okidata] - [Configuration Tool].

2 Select this machine from [Registered Device Table].

3 Select the [User Setting] tab.

4 Click [Role management].

5 Input the admin password, and click [OK].

 [Admin password\(P.195\)](#)

6 Click [User Name/Group].

7 Click the [New(User)] icon.

8 Input the user name and password.

Set other necessary information.

Name:Input the display name.

E-mail Address:Input the user's e-mail address.

Language Code:Input the language code.

PIN:Input the user's PIN.

Card ID: Input the user's IC card information.

Role:Set the user's role.

Group:Set the group to which the user belongs



- You can input the PIN as a user setting option.
- "admin" cannot be registered as a new user name.

9 Click [OK].

10 Click the [Save to Device] icon.

Changing user settings

1 Click [Start] and select [Okidata] - [Configuration Tool].

2 Select this machine from [Registered Device Table].

3 Select the [User Setting] tab.

4 Click [Role management].

5 Input the admin password, and click [OK].

 [Admin password\(P.195\)](#)

6 Click [User Name/Group].

7 Select the user name to be changed.

8 Change the settings as necessary, and click [OK].

9 Click the [Save to Device] icon.

Deleting a user

- 1 Click [Start] and select [Okidata] - [Configuration Tool].
- 2 Select this machine from [Registered Device Table].
- 3 Select the [User Setting] tab.
- 4 Click [Role management].
- 5 Input the admin password, and click [OK].
[Admin password](#)(P.195)
- 6 Click [User Name/Group].
- 7 Select the check box of the user to be deleted.
- 8 Click the [Delete] icon.
- 9 Click [Yes] on the confirmation screen.
- 10 Click the [Save to Device] icon.

Deleting this machine

You can unregister this machine.

- 1 Click [Start] and select [Okidata] - [Configuration Tool].
- 2 Right-click on this machine from [Registered Device Table].
- 3 Select [Remove device].
- 4 Click [Yes] on the confirmation screen.

Name and function of each screen

[Device Info] tab

Displays the information about the device.

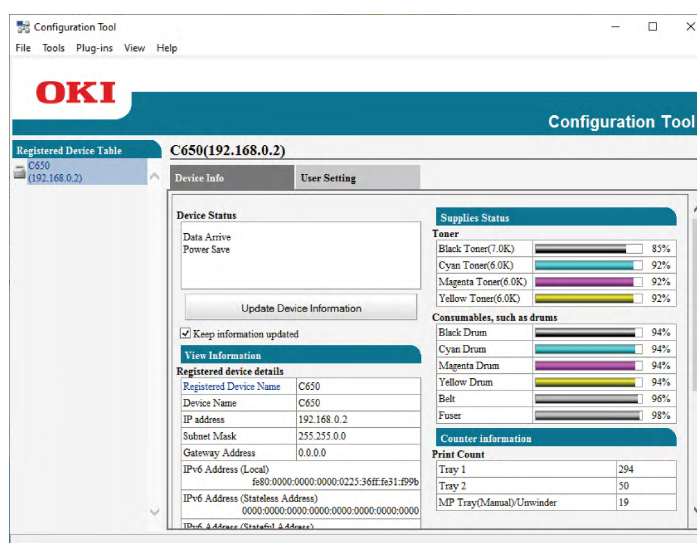

[User Setting] tab

Sets the user, role and so on.

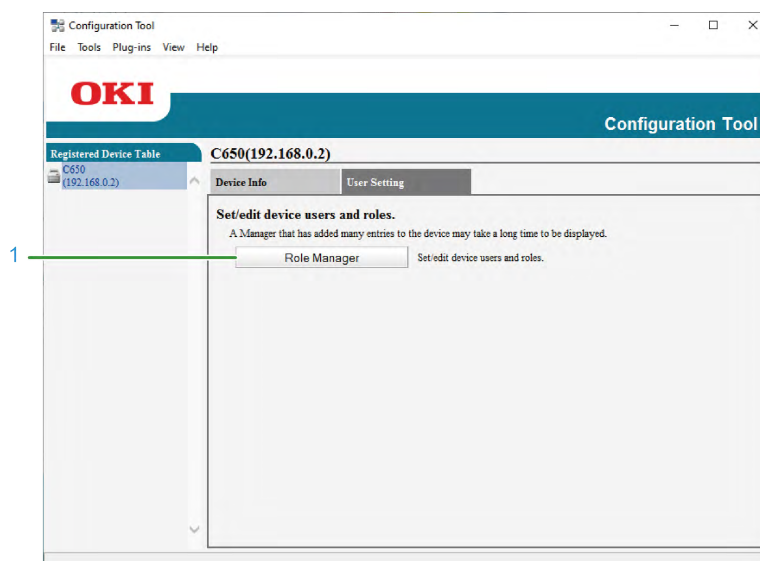

	Item	Description
1	Role management	Registers/Edits the user and role

[Alert Info] plug-in

Detects and notifies the event such as the end of printing.

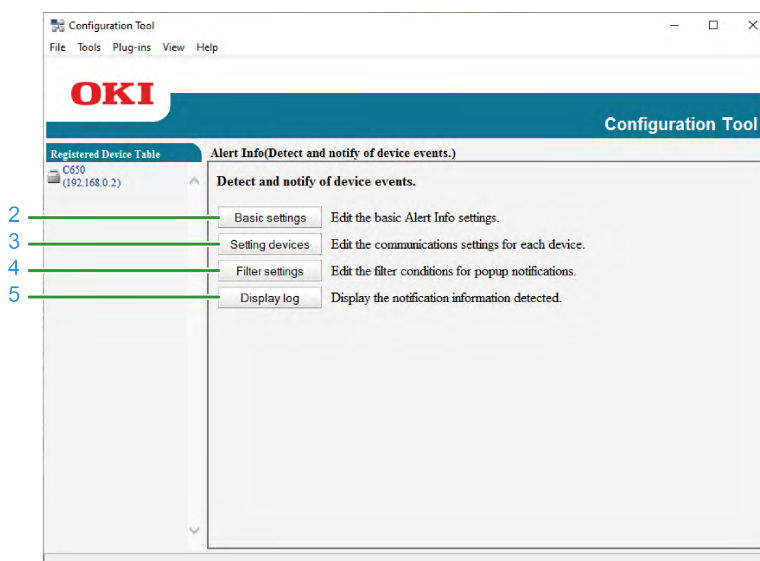

	Item	Description
2	Basic settings	Configures basic settings such as the notification method and detection interval
3	Setting devices	Sets the type and presence of the event notified by each device
4	Filter settings	Sets filter conditions for pop-up notifications
5	Display log	Displays detected notification information

[Network Setting] plug-in

Sets the network information.

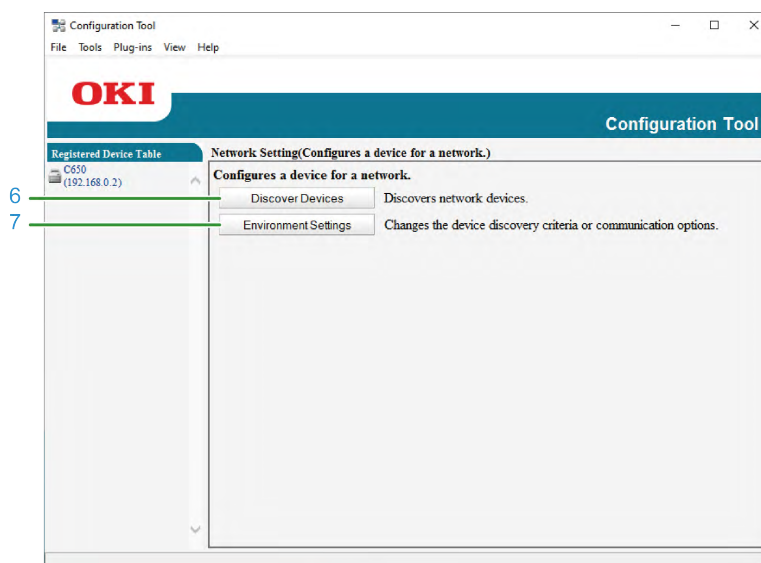





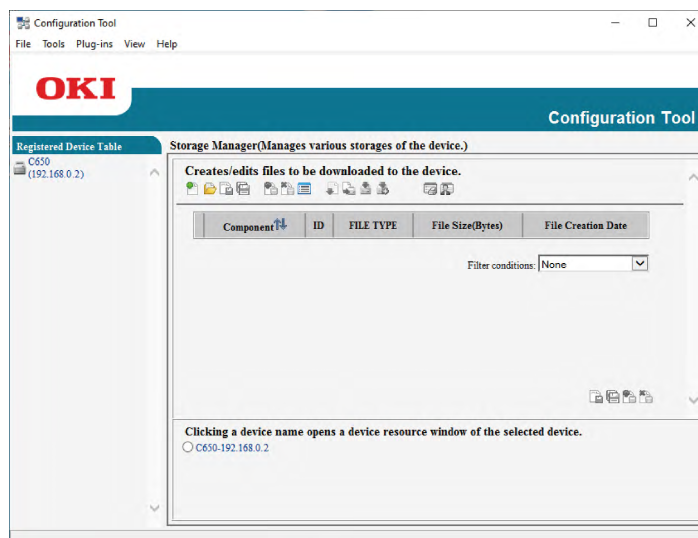

	Item	Description
6	Discover Devices	Searches for network devices.
7	Environment Settings	Changes the device detection criteria and communication options.

[Storage Manager] plug-in

Registers and edits files to be downloaded to the device.



Icon description

Icon	Icon name	Description
	Device Settings	Changes the IP address or other settings of this machine.
	Create New Project	Creates a new project.
	Add File to Project	Adds files to a project.
	Send Project	Sends a project to this machine.
	Save to Device	Saves the settings to this machine.
	New (User)	Creates a new user.
	Delete	Deletes a user.

OKI LPR Utility

With the OKI LPR Utility, you can print via a network, manage print jobs, or check the state of this machine. To use the OKI LPR Utility, TCP/IP must be enabled.



- The OKI LPR Utility cannot be used for shared printers. Please use the standard TCP/IP port.

Starting the OKI LPR Utility

- 1 Click [Start], and select [Okidata] - [OKI LPR Utility].

Registering this machine with the OKI LPR utility

Add this machine to the OKI LPR utility.



- Administrator privileges are required.
- If this machine cannot be added, exit the OKI LPR utility, right-click on [Start] - [Okidata] - [OKI LPR Utility], and select [More] - [Running As Administrator] to restart the utility.



- You cannot set a device that is already registered in the OKI LPR Utility. To change the port, select [Confirm Connections] from [Remote Print].

- 1 Start the OKI LPR Utility.
- 2 Select [Add Printer] from the [Remote Print] menu.
When [User Account Control] screen is displayed, click [Yes].
- 3 Select [Printer Name].
Networked printers and printers connected to the LPR port will not be displayed.
- 4 Input [IP Address]. Or, click [Discovery], select the model name to be registered from [Discovered Printer], and click [OK].
- 5 If necessary, input the information to identify this machine in [Comment].
- 6 Click [OK].

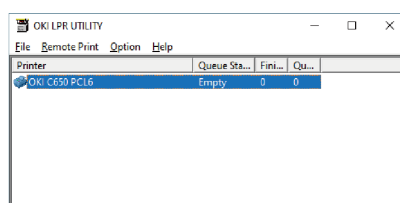

Checking the state of the registered machine

- 1 Start the OKI LPR utility.
- 2 Select this machine.
- 3 Select [Printer Status] from the [Remote Print] menu.

Transferring print data to the registered device

This section explains how to transfer the specified print data to a registered device using the OKI LPR utility. This section also explains how to transfer the print data to another device when a problem occurs on the destination device.



- Print data can be transferred only to devices with the same model name as your device.
- Before transferring print data, a device must be added.

Transferring the selected print data

- 1 Start the OKI LPR utility.
- 2 Select [Job Status] from the [Remote Print] menu.
- 3 Select the print data to be transferred, and select [Redirect] from [Job] menu.
- 4 Select the destination device, and click [OK].

Automatically transferring print data

When this machine cannot print since it is busy, offline, out of paper, etc., you can set the print data to be automatically transferred to another OKI machine.



- Administrator privileges are required.

- 1 Start the OKI LPR utility.
- 2 Select the machine to set.
- 3 Select [Confirm Connections] from the [Remote Print] menu.
- 4 Click [Detail Setup].
- 5 Check [Automatic Job Redirect Used].
- 6 To transfer the print data only when an error occurs, check [Redirect only at the time of an error].
- 7 Click [Add].
- 8 Input the IP address of the destination device, and click [OK].
- 9 Click [OK].

Printing the same document from multiple registered devices

You can print from multiple devices with a single order.



- Administrator privileges are required.

- 1 Start the OKI LPR utility.
- 2 Select the machine to set.
- 3 Select [Confirm Connections] from the [Remote Print] menu.
- 4 Click [Detail Setup].

- 5 Check [Print to more than one printer at a time].
- 6 Click [Options].
- 7 Click [Add].
- 8 Input the IP address of the devices to print at the same time, and click [OK].
- 9 Click [OK].

Opening the web page of a registered device

You can open the web page of this machine from the OKI LPR Utility.

- 1 Start the OKI LPR Utility.
- 2 Select this machine.
- 3 Select [Web Setting] from the [Remote Print] menu.



- When the web port number is changed, the web page cannot be opened.
For details, see "[Setting the port number of the web page for the registered device\(P.280\)](#)".

Automatically following the IP address of the registered device

You can set to maintain the connection to the original device even if the IP address of this machine is changed.



- Administrator privileges are required.



- The IP address may be changed when the IP address is dynamically allocated by DHCP, or when the network administrator has manually changed the IP address of this machine.

- 1 Start the OKI LPR utility.
- 2 Select [Setup] from the [Option] menu.
- 3 Check [Auto Reconnect], and click [OK].

Setting the port number of the web page for the registered device

- 1 Start the OKI LPR utility.
- 2 Select this machine.
- 3 Select [Confirm Connections] from the [Remote Print] menu.
- 4 Click [Detail Setup].
- 5 Input the port number of web page in [Port Numbers].
- 6 Click [OK].

Sending files to this machine registered with the OKI LPR utility

If this machine is connected to the network and registered with the OKI LPR utility, you can download the print data.

- 1 Start the OKI LPR utility.
- 2 Select the download destination device.
- 3 Select [Download] from [Remote Print].
- 4 Select the file and click [Open].
The file is sent to this machine.

Deleting unnecessary print data

You can use the OKI LPR utility to delete unnecessary print data.

- 1 Start the OKI LPR utility.
- 2 Select this machine.
- 3 Select [Job Status] from the [Remote Print] menu.
- 4 Select the print data to be deleted.
- 5 Select [Delete Job] from the [Job] menu.

Uninstalling OKI LPR utility



- Administrator privileges are required.

- 1 Make sure the OKI LPR utility is closed.
- 2 Click [Start], and select [Okidata] - [Uninstall OKI LPR Utility].
When [User Account Control] screen is displayed, click [Yes].
- 3 Click [Yes] on the confirmation screen.

Network Card Setup Utility (macOS)

The network setting can be done using the Network Card Setup Utility.
TCP/IP must be enabled to use the Network Card Setup Utility.

Setting the IP address

- 1 Start the Network Card Setup Utility.
[Installing software](#)(P.247)
- 2 Select this machine from the list.
- 3 Select [IP Address] from the [Actions] menu.
- 4 Specify the settings as necessary, and click [Config].
- 5 Input the admin password, and click [OK].
[Admin password](#)(P.195)
- 6 Click [OK] to enable the new settings.
The network card of this machine will restart.

Making web settings

You can set the network of this machine after starting the Network Card Setup Utility.

Enabling web settings

- 1 Start the Network Card Setup Utility.
[Installing software](#)(P.247)
- 2 Select this machine from the list.
- 3 Select [Web Page Settings] from the [Actions] menu.
- 4 Check [Enable device web settings], and click [Config].
- 5 Input the admin password, and click [OK].
[Admin password](#)(P.195)
- 6 Click [OK] in the confirmation window.

Opening the web page

- 1 Start the Network Card Setup Utility.
[Installing software](#)(P.247)
- 2 Select this machine from the list.
- 3 Select [View Printer Web Pages] from the [Actions] menu.
The web page will start, and the status page of this machine will be displayed.

Exiting the Network Card Setup utility

- 1 Select [Exit the Network Card Setup Utility] from the [Network Card Setup Utility] menu.

Print Job Accounting Client

The Print Job Accounting Client is a program for setting the user information in the printer driver so as to use the job accounting function and the access control function of this machine.

For Windows

You can set the user name and user ID (PIN) in the printer driver.



- Since the job account mode will be disabled after the printer driver is updated or reinstalled, please reset the job account mode. However, when all printer drivers are set to the same mode, it is not necessary to reset the mode.

Setting the user name and user ID

You can set the user name and user ID using "Properties" in the printer driver.

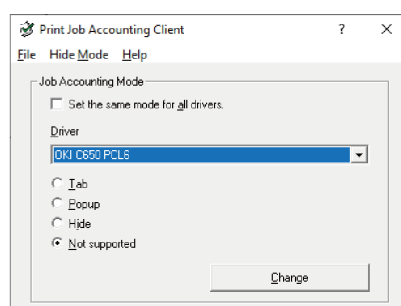

- 1 Click [Start], and select [Okidata] - [Print Job Accounting Client].
- 2 From the list of drivers, select the driver you want to set.
To set all printer drivers to the same mode, check [Set the same mode for all drivers].
- 3 Select [Tab], and click [Change].
A window is displayed.
- 4 Click [OK].
- 5 Select [Close] from the [File] menu.
- 6 Open the "Devices and Printers".
[How to open the printer folder\(P.142\)](#)
- 7 Right-click on the printer icon, and select [Printer Properties].
- 8 Select the [Job Accounting] tab, input the user name and user ID, and click [OK].

Setting the pop-up mode

With this feature, each time you start printing, you need to enter a user name and a user ID.

- 1 Click [Start], and select [Okidata] - [Change Job Account Mode].
- 2 From the list of drivers, select the driver you want to set.
- 3 Select [Popup], and click [Change].
A window is displayed.
- 4 Click [OK].

- 5 Select [Close] from the [File] menu.

Setting the user ID for each user in the hide mode

The system administrator creates beforehand the ID file that describes the user ID and user name corresponding to the login user name for Windows. Since users are identified by this software, you do not have to enter a user name or ID when printing.

Please use the hide mode with shared printers.

- 1 Create an ID file with the Notepad or spreadsheet software.



- ID files are listed in the following order.
Login user name (the user name input when logging into Windows), user ID (the user ID corresponding to the login user name), and the user name
- The user name can be omitted. When omitted, the user name will follow the login user name.
- Separate each item with a comma.
- For the spreadsheet software, input one login user name, one user ID, and one user name on each line.

- 2 Save the file in "CSV" format.

- 3 Click [Start], and select [Okidata] - [Change Job Accounting Mode].

- 4 From the list of drivers, select the driver you want to set.

To set all printer drivers to the same mode, check [Set the same mode for all drivers].



- When using a shared printer, do not use the function to set all printer drivers to the same mode. The account information is not output when you are printing from a shared printer client.

- 5 Select [Hide], and click [Change].

- 6 Click [OK].

- 7 Select [Import ID file] from the [Hide Mode] menu.

- 8 Specify the ID file created in Step 1, and click [Open].

- 9 Uncheck [Set fixed Job Account ID for all users] from the [Hide Mode] menu.

- 10 Select [Close] from the [File] menu.

For macOS

It is a print job accounting client.

You can set the user name and user ID in the printer driver.

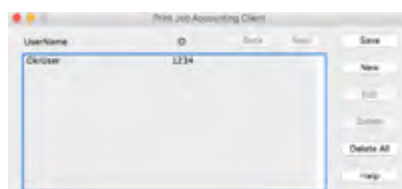

Registering the user ID

- 1 Start the Print Job Accounting client.
- 2 Click [New].
- 3 Input your macOS login name, new user name and new user ID, and click [Save].
- 4 Click [Save].
- 5 Exit the Print Job Accounting client.

Registering multiple users simultaneously

You can register multiple user IDs and user names simultaneously using a CSV file.



- The following procedure uses TextEdit as an example.

- 1 Start the TextEdit.
- 2 Input the login name, user ID and user name in order, separated by commas.
- 3 Save the file in CSV format.
- 4 Start the Print Job Accounting Client.
- 5 Select [Import] from the [File] menu.
- 6 Select the CSV file created in Step 3 and click [Open].
- 7 Click [Save].
- 8 Exit the Print Job Accounting Client.

Changing the user ID and user name

- 1 Start the Print Job Accounting Client.
- 2 Select the user to be changed, and click [Edit].
- 3 Input the new user ID and user name, and click [Save].
- 4 Click [Save].
- 5 Exit the Print Job Accounting Client.

Deleting the user ID and user name

- 1 Start the Print Job Accounting Client.
- 2 Select the user to be deleted, and click [Delete].
- 3 Click [Save].
- 4 Exit the Print Job Accounting Client.

8

Printing from a mobile device

Printing from a mobile device.....	287
Showing troubleshooting tips on a mobile device	291
Troubleshooting for the mobile device	292

Printing from a mobile device

Using the Mobile Print

Mobile Print is an application that allows you to print photos, images, etc. stored on your smartphone, tablet or other mobile devices, web pages displayed on the Web browser, and photos taken with the built-in camera directly onto an OKI printer or MFP from your smartphone, tablet or other mobile devices.

Download Mobile Print from App Store or Google Play Store.



- The Android version can also be downloaded from the website.

For details on the procedure, please refer to the "Mobile Print Web Manual" on the website.

Printing by connecting to an access point

- 1 Connect the mobile device to the same network as this machine.
Connect to a wireless LAN access point in the same network as this machine, or directly to this machine via Wireless(AP Mode).
[Connecting via a wireless LAN\(P.41\)](#)
- 2 Register this machine in the app and set it as the output destination.
If it has already been registered, only the destination is set.
- 3 Select the target you want to print.
- 4 Tap [Print].

Printing with the NFC function

If your mobile device supports the NFC function, you can print using the NFC function of this machine.

To print using the NFC function, it is necessary to set the wireless LAN (AP mode) of this machine to [Enable].



- You cannot use wireless LAN (AP mode) while using wireless LAN (Infrastructure).

Enabling wireless LAN (AP mode)

- 1 Check that "Ready To Print" appears on the display.

 - If the machine is in the power save mode, press «POWER SAVE» to restore.
- 2 Press the scroll buttons several times to select [Wireless(AP Mode) Setting], and press «OK».
- 3 Input the admin password using the numeric keypad, and press «OK».
[Admin password\(P.195\)](#)
- 4 Select [Wireless(AP Mode)], and press «OK».
- 5 Select [Enable], and press «OK».
- 6 Press «ON LINE» to return to the standby screen.

Printing with this machine registered with the app

- 1 Enable the NFC function of your mobile device, and enable Wi-Fi.
- 2 Bring the NFC antenna of the mobile device close to the NFC mark on this machine's operator panel.

This machine is registered to the mobile device application. If it has already been registered, only the destination is set.



- For iOS, it is necessary to display the NFC reading screen on the application in advance.

- 3 Select the target you want to print.
- 4 Tap [Print].



- As the position of the NFC antenna differs for each mobile device, please refer to the manual of your mobile device for further details.
- If the printing has failed, check the Wi-Fi settings of your mobile device, and register this machine with the application again.

AirPrint

With AirPrint (Print), you can print without installing the printer driver. You can print with AirPrint (Print) from your iPhone, iPad and iPod touch. This section describes an overview of AirPrint and its basic settings.

About AirPrint (Print)

AirPrint (Print) is a feature that allows you to easily print from your Mac. You can print with AirPrint (Print) from your iPhone, iPad and iPod touch. Mobile devices and Mac can detect this machine automatically.

With AirPrint (Print), you can easily print photos, emails, web pages, etc., displayed on the screen with 2 or 3 taps on the screen.

To use this feature, you should connect this machine and Mac via a wired LAN, wireless LAN or USB cable.

For details about AirPrint, please check the Apple website.

Setting AirPrint (Print)

- 1 Connect this machine to the same network as the mobile device.
Connect this machine and the mobile device via a wireless LAN access point or directly with a wired LAN (AP mode).
Connect this machine and access point via a wireless LAN (Infrastructure) or wired LAN.
To connect via wireless LAN (Infrastructure), please set it in beforehand.

[Connecting via a wireless LAN\(P.41\)](#)

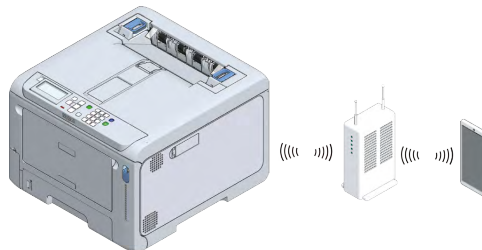

When connecting via a wired LAN, connect this machine to the access point with a LAN cable.

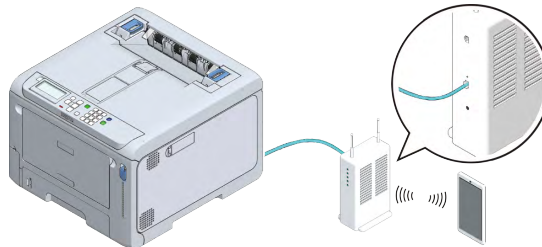

To connect via a wireless LAN (AP mode), please set it beforehand.

[Connecting via a wireless LAN\(P.41\)](#)

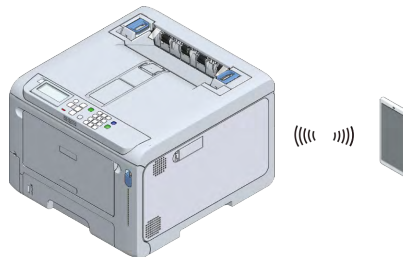

- 2 When using from a Mac, connect this machine to the Mac.
- 3 When printing via AirPrint (Print), set from the mobile device.
See "[Printing with AirPrint \(Print\)](#)".

Registering this machine on Mac

When using AirPrint (Print) for the first time, register this machine on your Mac.

- 1 Turn on the power of this machine and the PC.
- 2 Connect this machine and the PC via a wireless or wired LAN.
- 3 Select [System Preferences] from the Apple menu.
- 4 Click [Printers & Scanners].
- 5 Click [+], and then click [Add Printer or Scanner].
- 6 Select [OKI-C650-*****] , and click [Add].

- 7 Make sure that this machine is displayed in [Printer] and [C650-AirPrint] is displayed in [Type].
- 8 Close [Printers & Scanners].

Printing with AirPrint (Print)

When using AirPrint on a Mac, register this machine on Mac in advance.

 [Registering this machine on Mac](#)

Printing from an iOS device

1 Open the file to be printed.

2  Tap (Operation).

3  Tap (Print).

The model name of the previously used printer on the same network is displayed.



- When printing for the first time or when a model name other than this machine is displayed, select this machine in Step 4.

4 Tap [Print] to select this machine.

Functions supported by this machine are displayed.

5 Set options.

6 Tap [Print].

Printing from Mac

1 Open the file to be printed.

2 Select [Print] from the [File] menu.

3 Select [OKI-C650-*****] from [Print].

4 Set options.

5 Click [Print].

Showing troubleshooting tips on a mobile device

If an error has occurred in the machine, pressing «HELP» on the operator panel will display the error correction method on the display.

At this time, if you move the mobile device*¹ closer to the NFC mark on this machine when "NFC" appears on the upper left corner of the display, the search result of the page of a more detailed solution from "Frequently Asked Questions (FAQ)" on the website will be displayed on the mobile device.

*¹ Your mobile device needs to come with the NFC function, and the NFC function must be enabled.

Also, the Mobile Print must be installed and Internet connection is required. Communication charges may be incurred depending on the Internet connection method of your mobile device.

For details, please refer to the "Mobile Print Web Manual" on the website.

Troubleshooting for the mobile device

Troubleshooting for MobilePrint



- This machine may take 2 to 3 minutes to join a network after power-on. Make sure that the machine is connected to the network before attempting to print.

This machine cannot be registered in the app

Cause	Solution	Reference
Is the wireless setting of this machine set to the AP mode?	Enable the AP mode.	Using the Mobile Print(P.287)
Is the NFC setting of this machine set to [Enable]?	Check the status of [Admin Setup] - [Others Setup] - [NFC Setup] on this machine. If [Disable] is displayed, the NFC function is not available. Set it to [Enable].	-
Is the wireless setting of the mobile device enabled?	Enable the wireless setting on your mobile device.	-

Unable to print

Cause	Solution	Reference
Is the machine powered on?	Please power this machine on. If the power is on, turn the power off and then on again to see if the problem is solved.	Turning the power on(P.71) Turning the power off(P.71)
When printing with the NFC function, are this machine and the mobile device set to communicate in the AP mode?	Enable the AP mode of this machine. Enable Wi-Fi on the mobile device and set the connection destination to this machine.	Using the Mobile Print(P.287)
Is there any paper?	Make sure that the out-of-paper message is not displayed.	Error message list(P.327) When an error message appears on the display(P.326)
Is there any toner?	Make sure that the out-of-toner message is not displayed.	Error message list(P.327) When an error message appears on the display(P.326)
Is any error displayed?	Check the error message.	Error message list(P.327) When an error message appears on the display(P.326)

Troubleshooting for AirPrint



- This machine may take 2 to 3 minutes to join a network after power-on. Make sure that the machine is connected to the network before attempting to print.
- For macOS or iOS, please update the software to the latest version before printing.

When "No AirPrint Printers Found" is displayed on an iOS device

Cause	Solution	Reference
Is the machine powered on?	Please power this machine on. If the power is on, turn the power off and then on again to see if the problem is solved.	Turning the power on(P.71) Turning the power off(P.71)
Is the machine connected to the same network as the iOS device?	Check if this machine is displayed on the iOS print screen. If this machine is not displayed, check the IP address.	-

Unable to print

Cause	Solution	Reference
Is the machine powered on?	Please power this machine on. If the power is on, turn the power off and then on again to see if the problem is solved.	Turning the power on(P.71) Turning the power off(P.71)
Is the machine connected to the same network as the iOS device?	Check if this machine is displayed on the iOS print screen. If this machine is not displayed, check the IP address.	-
Is the latest firmware installed?	Make sure that the firmware of this machine and the macOS and iOS software are of the latest versions. If they are not of the latest versions, please update them to the latest versions from the website or Apple's website.	-
Is there any paper?	Make sure that the out-of-paper message is not displayed.	Error message list(P.327) When an error message appears on the display(P.326)
Is there any toner?	Make sure that the out-of-toner message is not displayed.	Error message list(P.327) When an error message appears on the display(P.326)
Is AirPrint set to [Enable]?	Press the scroll buttons on the operator panel several times to check the status of [AirPrint]. If [Disable] is displayed, AirPrint is not available.	-
Is any error displayed?	Check the error message.	Error message list(P.327) When an error message appears on the display(P.326)





9 Maintenance











Precautions for replacing consumables	295
Service life and replacement cycle of consumables	296
Replacing the black(K) toner cartridge and the waste toner box	298
Replacing the toner cartridge (C/M/Y).....	301
Replacing the image drum	303
Service life and replacement cycle of maintenance parts.....	306
Replacing the belt unit.....	308
Replacing the fuser unit	310
Cleaning the main unit and the parts	312
Updating software	321
Deleting software.....	322
Firmware update	324

This section explains how to maintain this machine for a long and comfortable use.

Precautions for replacing consumables

Note the following points during the replacement.

 WARNING	
	Do not throw the toner, toner cartridge or waste toner box into fire. Toner may fly off, thus causing burns.
	Do not store the toner cartridge and waste toner box in a place with fire. Doing so may cause a fire or burns.
	Do not clean up spilled toner using an electric vacuum cleaner. When spilled toner is cleaned up using an electric vacuum cleaner, a fire may be caused due to sparks from electrical contacts. Wipe off and remove the toner spilled on the floor using a wet cloth.
	As the fuser unit may be hot, be cautious during operation and always hold the handle to lift it. When it is hot, wait until it cools down before any operation.

 CAUTION	
	There are high-temperature parts inside the machine. Do not touch the area with the "Caution: High Temperature" label. Doing so may cause burns.
	Keep the toner cartridge and waste toner box out of the reach of children. If children swallow toner by mistake, immediately consult a physician.
	When toner is inhaled, gargle with a lot of water and move the person to a place with fresh air. Consult a physician as necessary.
	When toner gets contact with the skin of your hands etc., wash it off with soapy water.
	If toner gets into your eyes, immediately wash it off with a large quantity of water. Consult a physician as necessary.
	When toner is swallowed, exhale the toner. Consult a physician as necessary.
	When clearing a paper jam or replacing the toner cartridge and the waste toner box, take care that your hands and clothes are not stained with toner. When clothes are stained with toner, wash them in cold water. Heating it like washing in hot water may dye the toner on clothes, and the stains may not be removed easily.
	Do not disassemble the image drum, toner cartridge, waste toner box or belt unit. Doing so may scatter the toner, which may be inhaled by people or may stain clothes or hands.
	Store the used toner cartridge and the waste toner box in a bag so that toner does not scatter.



- Use genuine OKI consumables for optimum performance.
- Failures caused by using non-genuine consumables may void the warranty or maintenance contract. (The use of non-genuine consumables will not necessarily cause failures, but please fully take notice of such usage.)

Service life and replacement cycle of consumables

Toner cartridge

Service life of the toner cartridge

To check the remaining toner amount, select the toner of each color in [Configuration] - [Supplies Status] from the operator panel.

Replacement cycle of the toner cartridge

When the time for replacement is approaching or has arrived, the following message appears on the display.

	<u>When the time for replacement is approaching</u>	→	<u>When the time for replacement has arrived</u>
Displayed message	Cyan/Magenta/Yellow/Black (K) Toner Low.	→	Cyan/Magenta/Yellow/Black (K) Toner Is Empty. Replace With A New Toner Cartridge.
Response to the message	Prepare a new toner cartridge of the displayed color.	→	Replace the toner cartridge with a new one.
State of this machine	Printing is possible, but the toner of the displayed color is low.	→	The toner of the displayed color is empty. Printing stops.

About 200 pages can be printed from when the time for replacement is approaching to when the time for replacement has arrived. (This is the reference value in the case of A4 simplex printing with a density of 5%.)



- Printing quality will decline after the toner cartridge stays unpacked for one year or longer. Therefore, prepare a new toner cartridge.
- Use genuine OKI consumables for optimum performance.
- Failures caused by using non-genuine consumables may void the warranty or maintenance contract. (The use of non-genuine consumables will not necessarily cause failures, but please fully take notice of such usage.)
- Printing under the following conditions may damage the image drum. Replace the toner cartridge immediately.
 - Opening and closing the front cover with toner empty
 - Printing in mono without cyan (blue), magenta (red) or yellow (yellow) toner
- Replace the toner cartridge immediately when a message indicating replacement of the toner cartridge is displayed and printing has stopped.
- If you repeatedly open and close the front cover so that you can continue printing temporarily, a failure may be caused or the print quality may be degraded.
In addition, after a certain period of time, printing will be disabled even if you open and close the front cover. (The printable period of time varies with the usage condition.)

 [Replacing the black\(K\) toner cartridge and the waste toner box\(P.298\)](#)

 [Replacing the toner cartridge \(C/M/Y\)\(P.301\)](#)

Image drum

Service life of the image drum

The image drum can print approximately 50,000 sheets of A4-sized paper (for simplex printing), but the actual printable number of sheets may vary with the usage condition.

The above number is based on the general usage condition (three sheets at a time). If you print a single sheet at a time, the life may be reduced by half. A message appears indicating preparation for replacement when the end of life is approaching.

To check the life of the image drum, select the image drum of each color in [Configuration] - [Supplies Status] from the operator panel.

Replacement cycle of the image drum

When the time for replacement is approaching or has arrived, the following message appears on the display.

	<u>When the time for replacement is approaching</u>	→	<u>When the time for replacement has arrived</u>
Displayed message	Cyan/Magenta/Yellow/Black (K) Image Drum Near Life.	→	Cyan/Magenta/Yellow/Black (K) Image Drum End Of Life. Replace With A New [Color Name] Image Drum
Response to the message	Prepare a new image drum of the displayed color.	→	Replace the image drum with a new one.
State of this machine	Printing is possible, but the image drum of the displayed color is approaching the end of its service life.	→	The image drum of the displayed color has reached the end of its service life. Printing stops.

About 1,500 pages can be printed from when the time for replacement is approaching to when the time for replacement has arrived.



- Printing quality will decline after the image drum stays unpacked for one year or longer. Therefore, prepare a new image drum.
- Because the image drum (green part) can easily get damaged, handle with adequate care.
- Do not expose the image drum to direct sunlight or strong light (About 1,500 lux or above). Do not leave it uncovered for more than 5 minutes even under room lighting.
- Use genuine OKI consumables for optimum performance.
- Failures caused by using non-genuine consumables may void the warranty or maintenance contract. (The use of non-genuine consumables will not necessarily cause failures, but please fully take notice of such usage.)
- Replace the image drum immediately when a message indicating replacement of the image drum is displayed and printing has stopped.

If you repeatedly open and close the front cover so that you can continue printing temporarily, a failure may be caused or the print quality may be degraded.

In addition, after a certain period of time, printing will be disabled even if you open and close the front cover. (The printable period of time varies with the usage condition.)

- If [Admin Setup] - [Panel Setup] - [Near Life Status] is set to [Disable], a message indicating the time for replacement will not be displayed.



- You can change the timing for displaying a message indicating the time for replacement of the image drum. The factory default value is [1500].
This timing can be set from [Admin Setup] - [Others Setup] - [Near Life Setup] - [Drum Near Life Timing] on the operator panel.
The setting range is from 500 to 5,000 (in increments of 500).

[Replacing the image drum\(P.303\)](#)

Replacing the black(K) toner cartridge and the waste toner box

The black(K) toner cartridge comes with a waste toner box.

By following on-screen instructions, replace the waste toner box first and then the black(K) toner cartridge.

- 1 Press the knob on the lower left corner on the front of the machine, and open the waste toner box cover toward you.

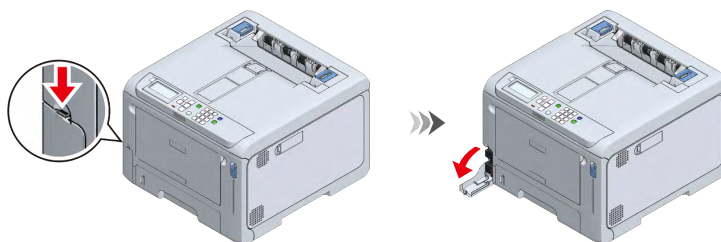

- 2 Put your finger on the recess of the waste toner box, pull it out halfway, and pull it out by the top.

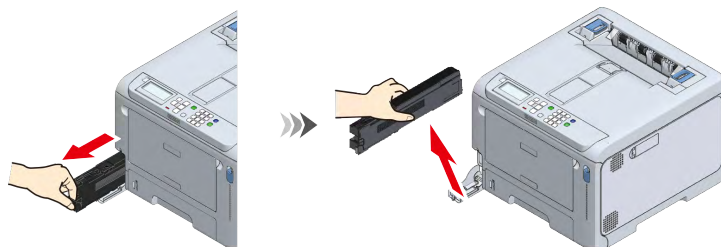

- 3 Prepare a new waste toner box.



- 4 Install the new waste toner box into this machine.

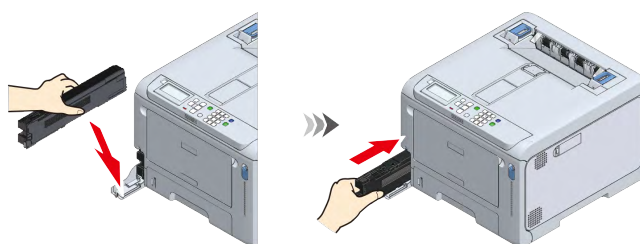

- 5 Close the cover of the waste toner box.

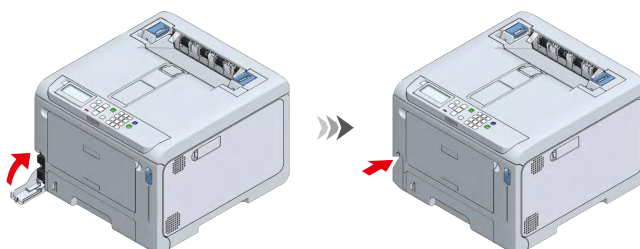

- 6** Take the new black(K) toner cartridge out of its packing box.



- 7** Shake the new toner cartridge both horizontally and vertically for several times.



- 8** Pull the front cover open lever (blue) to open the front cover.

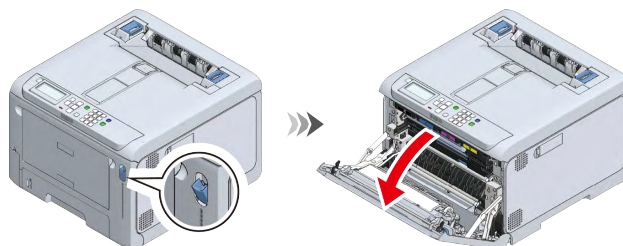

- 9** Pull out the black(K) toner cartridge from the machine.

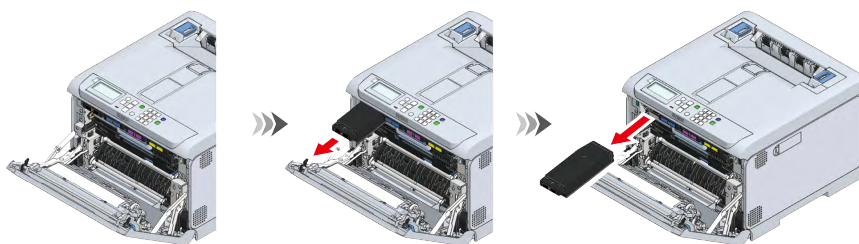

- 10** Install the new black(K) toner cartridge into the machine.

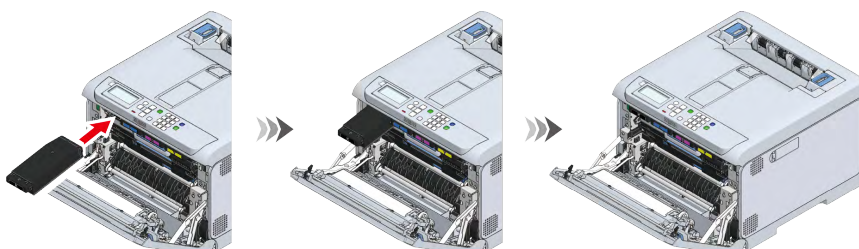

- 11** Close the front cover firmly with both hands.

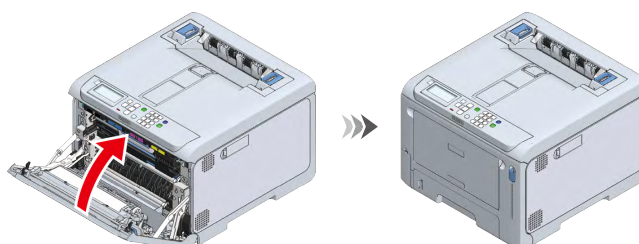

12 Press «OK».

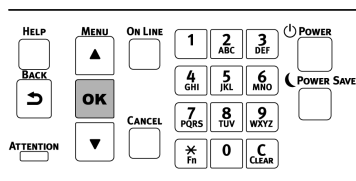

13 Check that no error message appears on the display.



- Please recycle the used toner cartridge and waste toner box.

Replacing the toner cartridge (C/M/Y)

This section takes the toner cartridge (M) as an example. The toner cartridge (C/Y) can be replaced by the same procedure.



- To replace the black toner cartridge (K), please refer to "[Replacing the black\(K\) toner cartridge and the waste toner box\(P.298\)](#)".

- 1 Remove the new toner cartridge of the color to be replaced from its packing case.



- 2 Shake the new toner cartridge both horizontally and vertically for several times.



- 3 Pull the front cover open lever (blue) to open the front cover.

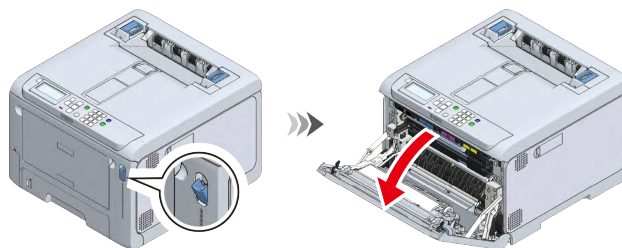

- 4 Remove the toner cartridge of the color to be replaced from the machine.



- 5 Insert the new toner cartridge into the machine.

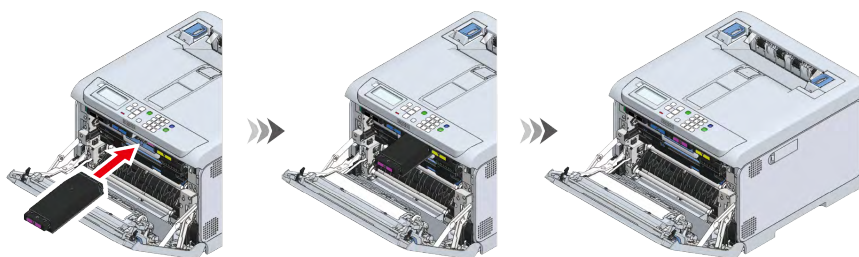

- 6 Close the front cover firmly with your both hands.

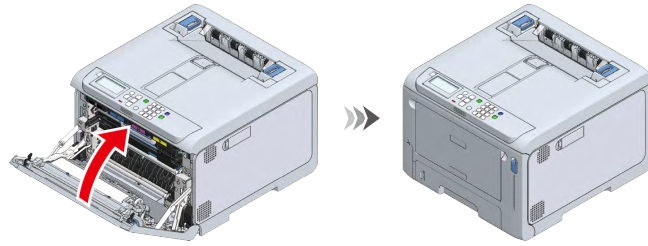

- Please recycle the used toner cartridge.

Replacing the image drum

- 1 Pull the front cover open lever (blue) to open the front cover.

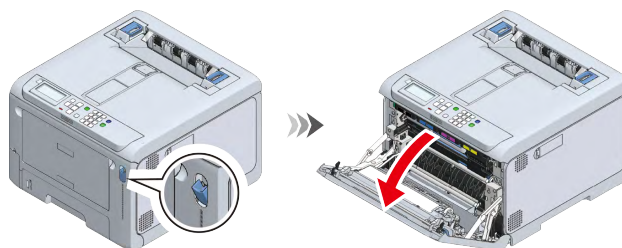

- 2 Pull the L1 lever towards you until the red triangle mark on the L1 lever is aligned with the red triangle mark inside the machine.



- If the two red triangle marks are not aligned correctly, you cannot proceed to the procedure of replacing the image drum.

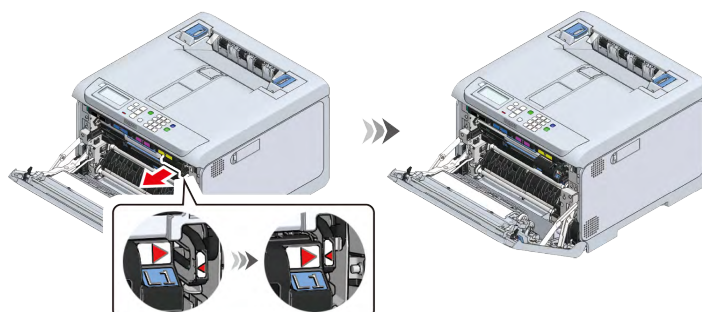

- 3 Pull the L2 lever and lift the output tray to the stop position.



- The image drum basket cannot be pulled out unless the output tray is fully open.

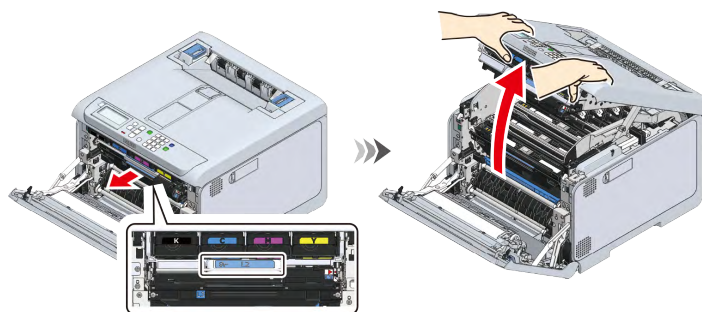

- 4 Hold the L3 handle and pull out the image drum basket until it stops.



CAUTION

Doing so may cause burns.



Do not touch the fuser unit because it is hot.

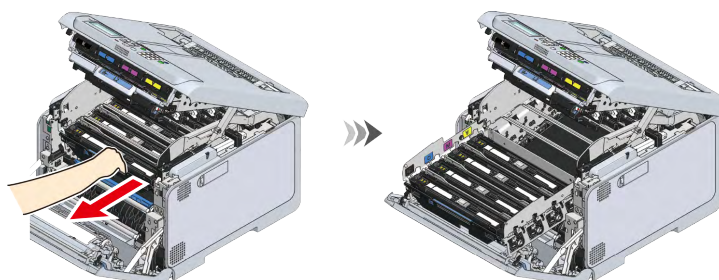

- 5 Check the image drum to be replaced by the label color.

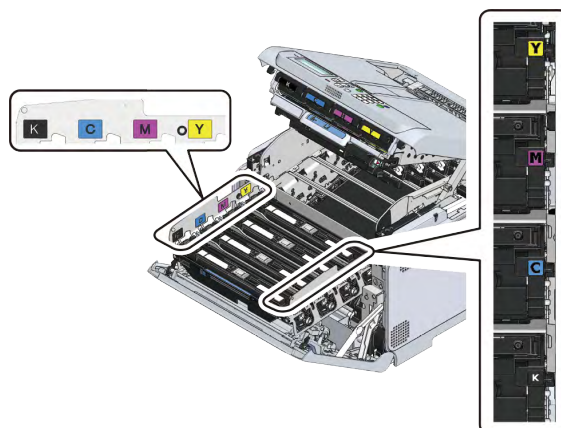

- 6 Remove the image drum of the color to be replaced.



- Because image drums (green parts) can easily get damaged, handle with adequate care.
- Do not expose the image drum to direct sunlight or strong light (About 1,500 lux or above). Do not leave it uncovered for more than 5 minutes even under room lighting.



- The image drum is not fixed in the main unit. You can just lift to remove it.

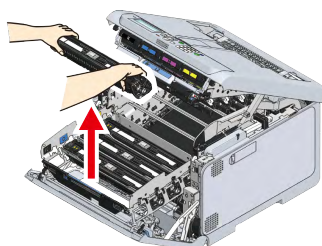

- 7 Take the new image drum of the color to be replaced out of its box.

- 8 Take out the desiccant of the new image drum.



- 9 Install the new image drum in this machine by holding it with the color label on the right.



- Because image drums (green parts) can easily get damaged, handle with adequate care.
- Do not expose the image drum to direct sunlight or strong light (About 1,500 lux or above). Do not leave it uncovered for more than 5 minutes even under room lighting.

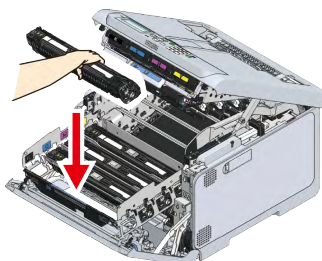

- 10 Hold the L3 handle and push the image drum basket all the way in.



- If the image drum is not installed correctly, the image drum basket cannot be pushed all the way in.

- The output tray cannot be closed unless the image drum basket is pushed all the way in.

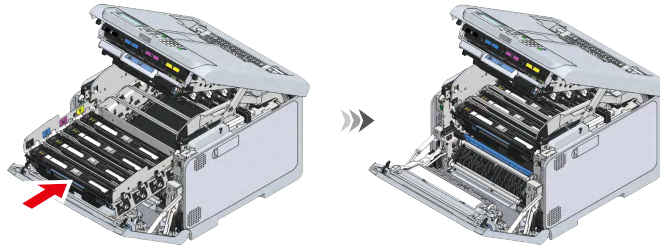

11 Close the output tray, and push both sides down from top.

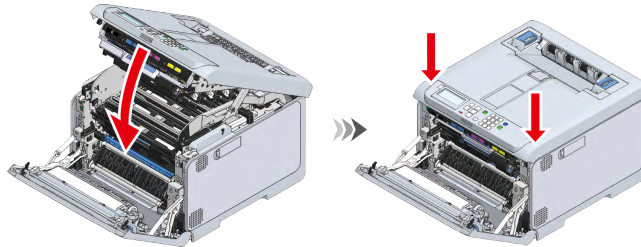

12 Press the L1 lever all the way in.



- The front cover cannot be closed unless all the image drums of the four colors are installed.

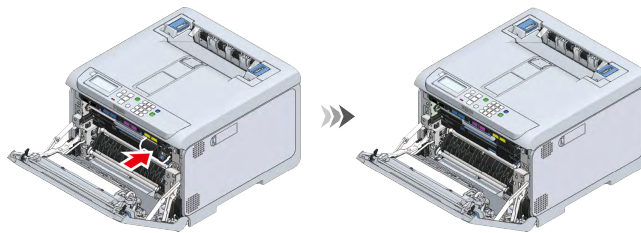

13 Close the front cover firmly with both hands.

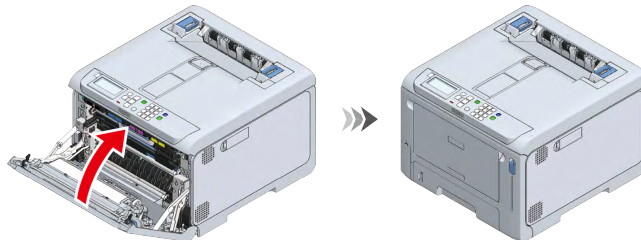

- Please recycle the used image drum.

Service life and replacement cycle of maintenance parts

Belt unit

Service life of the belt unit

The belt unit can print approximately 60,000 sheets of A4-sized paper (for simplex printing), but the actual printable number of sheets may vary with the usage condition.

The above number is based on the general usage condition (three sheets at a time).

To check the life of the belt unit, select [Functions] - [Configuration] - [Supplies Status] - [Belt] from the operator panel.

Replacement cycle of the belt unit

When the time for replacement is approaching or has arrived, the following message appears on the display.

	<u>When the time for replacement is approaching</u>	→	<u>When the time for replacement has arrived</u>
Displayed message	Belt Unit Near Life.	→	Belt Unit End Of Life. Replace With A New Belt Unit.
Response to the message	Please prepare a new belt unit.	→	Replace the belt unit with a new one.
State of this machine	Printing is possible, but the belt unit is approaching the end of its service life.	→	The belt unit has reached the end of its service life. Printing stops.

About 1,500 pages can be printed from when the time for replacement is approaching to when the time for replacement has arrived.



- A message indicating replacement of the belt unit may be displayed without displaying a message indicating that the time for replacement is approaching.
In this case, please replace the belt unit.
- Replace the belt unit immediately when a message indicating replacement of the belt unit is displayed and printing has stopped.
If you repeatedly open and close the front cover so that you can continue printing temporarily, a failure may be caused or the print quality may be degraded.
In addition, after a certain period of time, printing will be disabled even if you open and close the front cover. (The printable period of time varies with the usage condition.)
- If [Admin Setup] - [Panel Setup] - [Near Life Status] is set to [Disable], a message indicating the time for replacement will not be displayed.
- Because the image drum (green part) can easily get damaged, handle with adequate care.
- Do not expose the image drum to direct sunlight or strong light (About 1,500 lux or above). Do not leave it uncovered for more than 5 minutes even under room lighting.



- You can change the timing for displaying a message indicating the time for replacement of the belt unit. The factory default value is [1500].
This timing is set from [Admin Setup] - [Others Setup] - [Near Life Setup] - [Belt Near Life Timing] on the operator panel.
The setting range is from 500 to 5,000 (in increments of 500).

[Replacing the belt unit\(P.308\)](#)

Fuser unit

Service life of the fuser unit

The fuser unit can print approximately 60,000 sheets of A4-sized paper (for simplex printing), but the actual printable number of sheets may vary with the usage condition.

The above number is based on the general usage condition (three sheets at a time). If you print a single sheet at a time, the life may be reduced by half. A message appears indicating preparation for replacement when the end of life is approaching.

To check the life of the fuser unit, select [Functions] - [Configuration] - [Supplies Status] - [Fuser] from the operator panel.

Replacement cycle of the fuser unit

When the time for replacement is approaching or has arrived, the following message appears on the display.

	<u>When the time for replacement is approaching</u>	→	<u>When the time for replacement has arrived</u>
Displayed message	Fuser Near Life.	→	Fuser Unit End Of Life. Replace With A New Fuser Unit
Response to the message	Prepare a new fuser.	→	Replace With A New Fuser Unit.
State of this machine	Printing is possible, but the fuser unit is approaching the end of its service life.	→	Printing stops.

About 1,500 pages can be printed from when the time for replacement is approaching to when the time for replacement has arrived.



- Replace the fuser unit immediately when a message indicating replacement of the fuser unit is displayed and printing has stopped.
If you repeatedly open and close the front cover so that you can continue printing temporarily, a failure may be caused or the print quality may be degraded.
In addition, after a certain period of time, printing will be disabled even if you open and close the front cover. (The printable period of time varies with the usage condition.)
- If [Admin Setup] - [Panel Setup] - [Near Life Status] is set to [Disable], a message indicating the time for replacement will not be displayed.



- You can change the timing for displaying a message indicating the time for replacement of the fuser unit. The factory default value is [1500].
This timing is set from [Admin Setup] - [Others Setup] - [Near Life Setup] - [Fuser Near Life Timing] on the operator panel.
The setting range is from 500 to 5,000 (in increments of 500).

[Replacing the fuser unit\(P.310\)](#)

Replacing the belt unit

For the replacement cycle, see "Belt unit(P.306)".

- 1 Pull the front cover open lever (blue) to open the front cover.

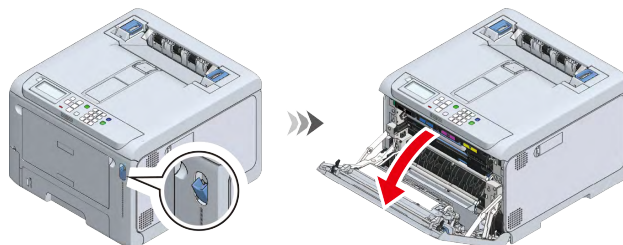

- 2 Pull the L2 lever and lift the output tray to the stop position.

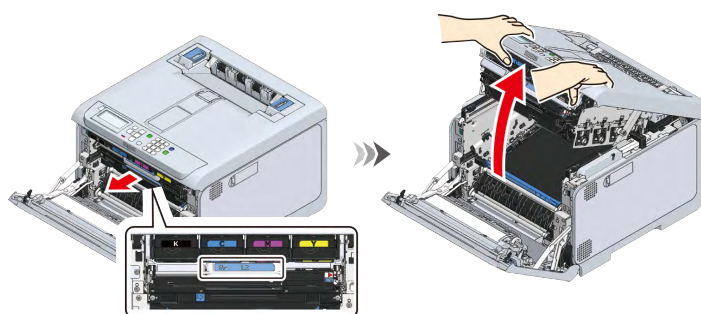

- 3 Remove the belt unit by holding its blue handle.

CAUTION

Doing so may cause burns.



Do not touch the fuser unit because it is hot.



- Because image drums (green parts) can easily get damaged, handle with adequate care.
- Do not expose the image drum to direct sunlight or strong light (About 1,500 lux or above). Do not leave it uncovered for more than 5 minutes even under room lighting.

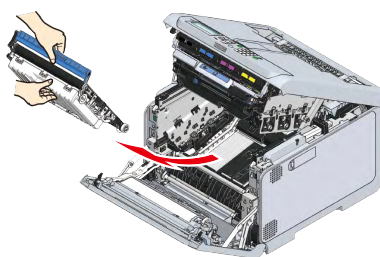

- 4 Take the new belt unit out of its box.



5 Install the belt unit in this machine by holding its blue handle.

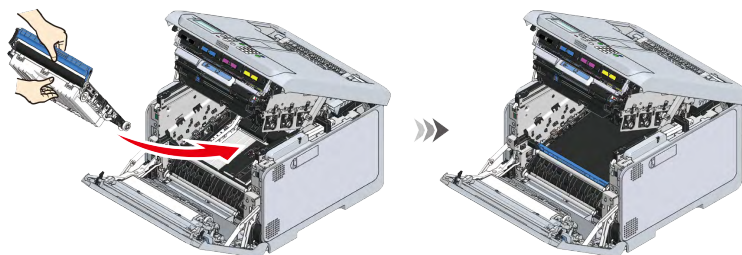

6 Close the output tray, and push both sides down firmly from top.

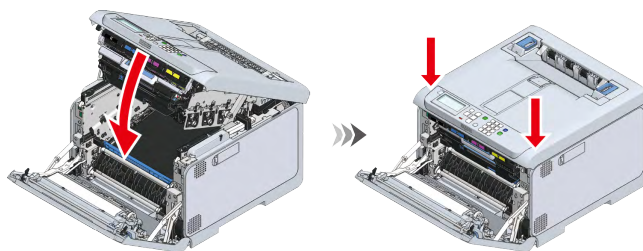

7 Close the front cover firmly with both hands.

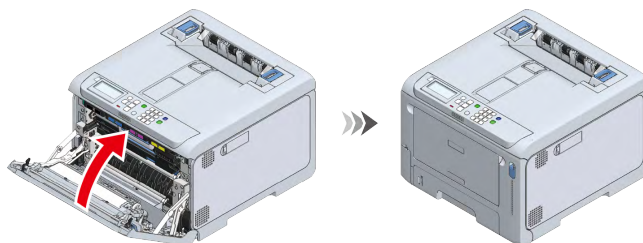

- Please recycle the used belt unit.

Replacing the fuser unit

For the replacement cycle, see "Fuser unit(P.307)".

- 1 Lift the left and right handles of the fuser unit at the back of the output tray until a click is heard, and then release the lock.



- The fuser unit cannot be removed unless its handle is raised vertically.

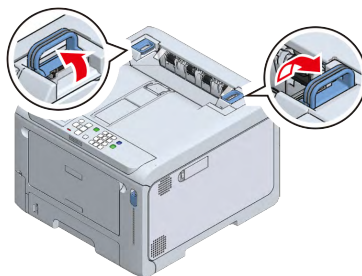

- 2 Remove the fuser unit from this machine by holding its left and right handles.



CAUTION

Doing so may cause burns.



When the fuser unit is hot, wait until it cools down before any operation.



- Do not expose this machine with the fuser unit removed to direct sunlight or strong light (About 1,500 lux or above). Do not leave it uncovered for more than 5 minutes even under room lighting.

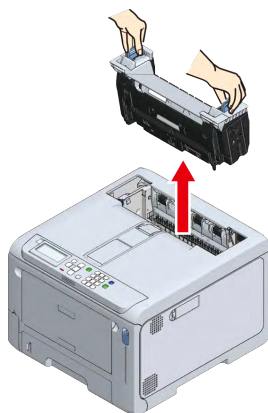

- 3 Take the new fuser unit out of its box, and lift the left and right handles up vertically until a click is heard.

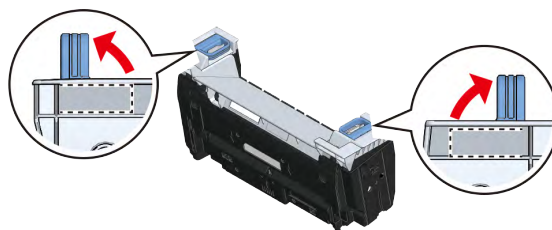

- 4 With the warning label of the new fuser unit facing the front, hold both the left and right handles and install the fuser unit into this machine.

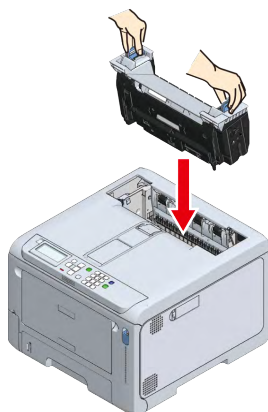

- 5 Push down the left and right handles of the fuser unit to lock.



- Make sure that the fuser unit does not float from the top of the output tray. If floating, the fuser unit will not be recognized so that it is not possible to start printing.

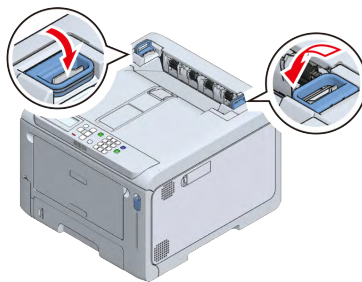

- Please recycle the used fuser unit.

Cleaning the main unit and the parts

Cleaning the LED head

If there are white stripes on the output paper, the image is faded or the text is blurred, clean the LED head.



- Do not use methyl alcohol or thinner. Doing so may damage the LED head.
- Do not expose the image drum to direct sunlight or strong light (About 1,500 lux or above). Do not leave it uncovered for more than 5 minutes even under room lighting.

- 1 Power off this machine.
- 2 Pull the front cover open lever (blue) to open the front cover.

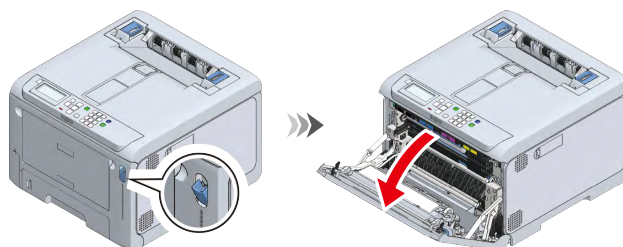

- 3 Pull the L1 lever towards you until the red triangle mark on the L1 lever is aligned with the red triangle mark inside the machine.



- If the two red triangle marks are not aligned correctly, you cannot separate the output tray and the image drum basket.

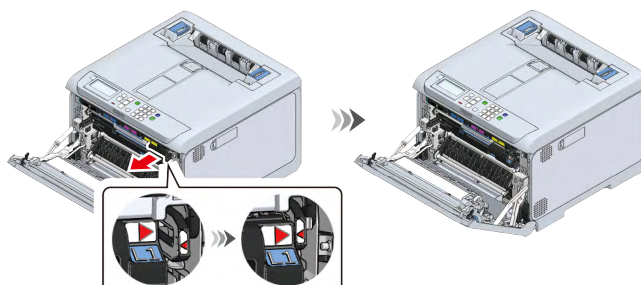

- 4 Pull the L2 lever and lift the output tray to the stop position.

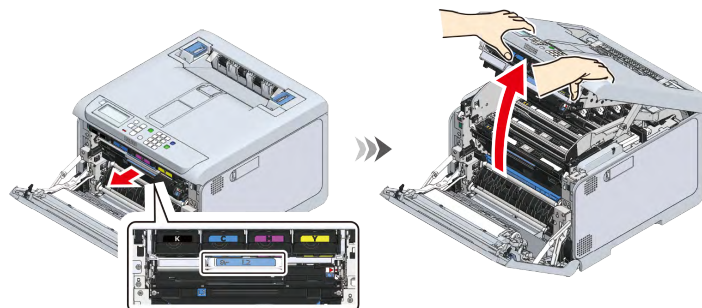

5 Gently wipe the lens surface of the LED head (x 4) with a soft tissue paper.



- Do not expose the image drum to direct sunlight or strong light (About 1,500 lux or above). Do not leave it uncovered for more than 5 minutes even under room lighting.

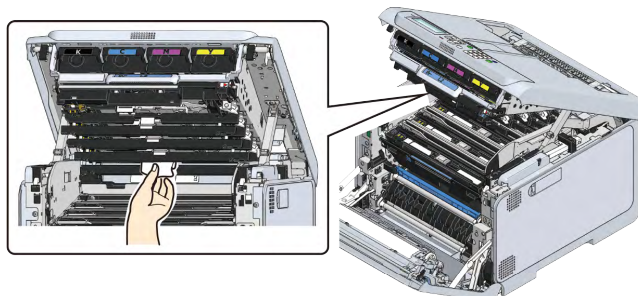

6 Close the output tray, and push both sides down from top.

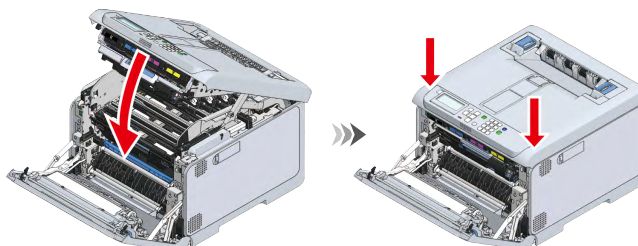

7 Press the L1 lever all the way in.

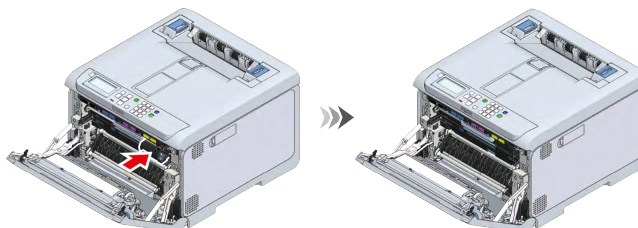

8 Close the front cover firmly with both hands.

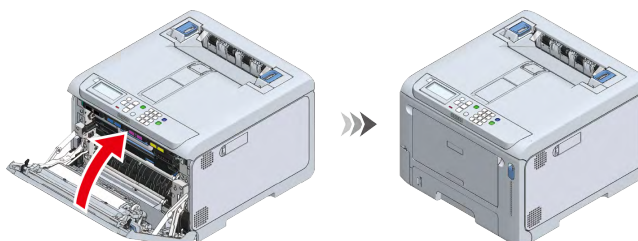

Cleaning the surface of the main unit



- Do not use benzene, paint thinner or alcohol as it may damage plastic parts and coating of this machine.
- It is not necessary to lubricate the parts of this machine. Do not lubricate.

1 Power off this machine.

- 2** Clean the surface of this machine with a cloth slightly moistened with water or a neutral detergent.



- Only use water or a neutral washing agent.

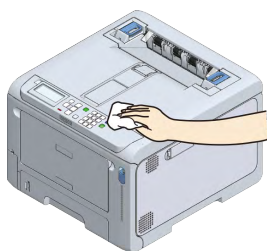

- 3** Wipe the surface of this machine with a soft dry cloth.

Cleaning paper feed rollers (Trays 1-4)

If paper jams occur frequently, clean the paper feed roller. Clean the separation roller of the paper cassette and the paper feed roller inside this machine.



- If paper jams persist even after the paper feed roller is cleaned, it is recommended to replace the paper feed roller. The following procedure takes Tray 1 for example. You can follow the same procedure to clean paper feed rollers for Tray 2, Tray 3 and Tray 4.

- 1** Pull out the paper cassette.

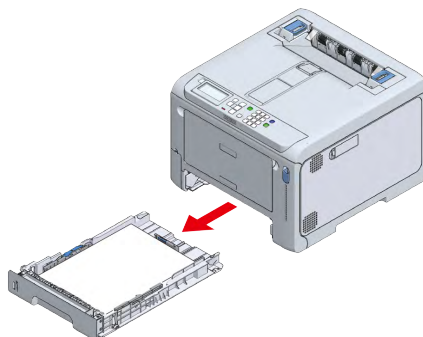

- 2** Wipe the two paper feed rollers inside this machine with a cloth slightly moistened with water.

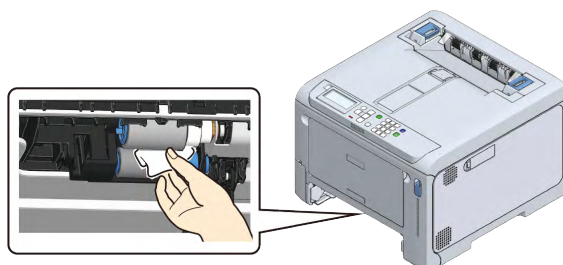

- 3 Remove the paper from the paper cassette.
- 4 Wipe the separation roller of the cassette with a cloth slightly moistened with water.

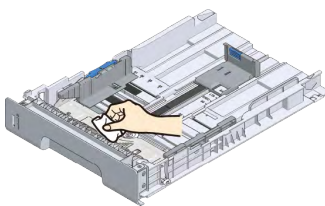

- 5 Load the paper in the paper cassette.
- 6 Return the paper cassette to this machine.

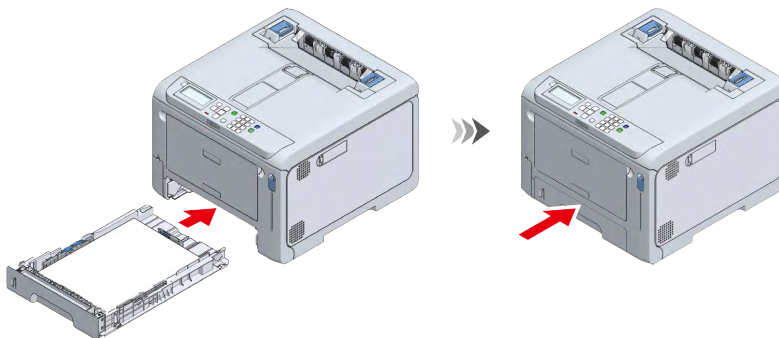

Cleaning the paper feed roller (MP tray)

If paper jams occur frequently, clean the paper feed roller.



- If paper jams persist even after the paper feed roller is cleaned, it is recommended to replace the paper feed roller.

- 1 Place your fingers in the front recess and pull to open the MP tray towards you.

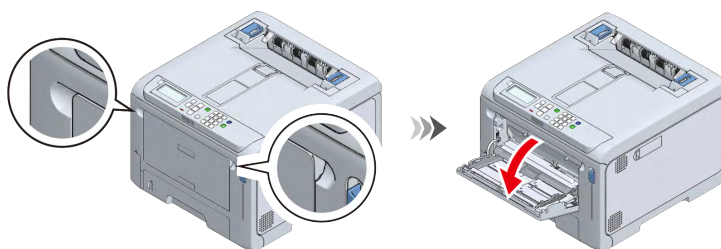

- 2 Slide the manual feeder guide inward.

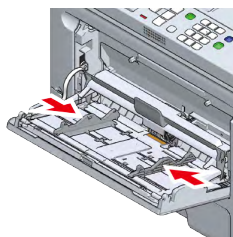

- 3 While lifting the MP tray gently, press the right arm inwards and remove the protrusion of the arm from the groove.

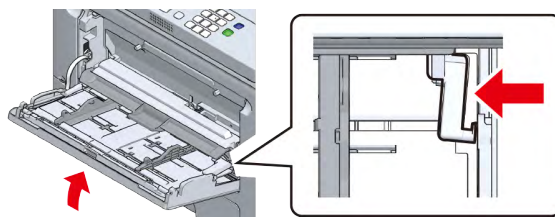

- 4 Lower the MP tray, and lift up the protrusion of the arm.

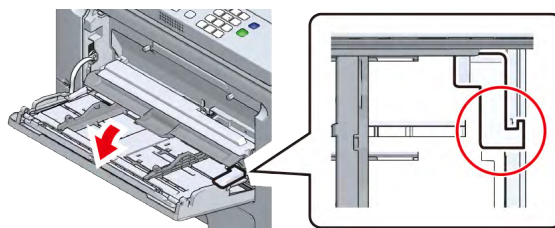

- 5 By referring to Steps 3 and 4, remove the protrusion of the left arm of the MP tray from the groove and lift it up.

- 6 Lift up the paper placement cover until it attaches to the machine.

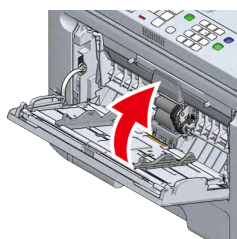

- 7 Press down on the center of the MP tray, and then press and hold the white part which is visible through the small window at the bottom of the separation roller cover. Remove the lower paper feed roller (without gear) by expanding the side protrusion outward and sliding it to the left.

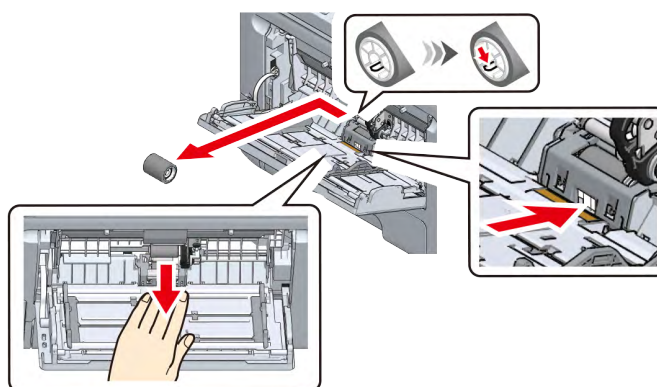

- 8** Press down on the center of the MP tray, place your finger over the small window on the separation roller cover and push it up to remove the separation roller.

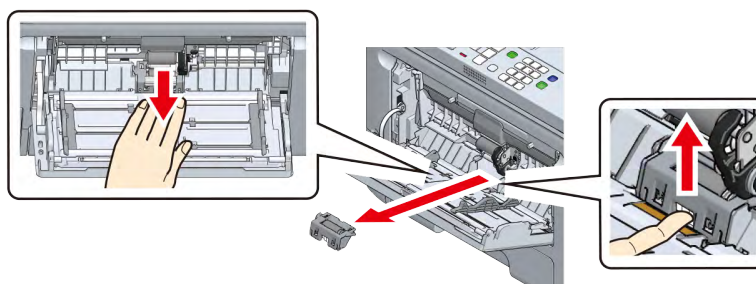

- 9** Wipe the separation roller with a cloth slightly moistened with water (while rotating it in the arrow direction).

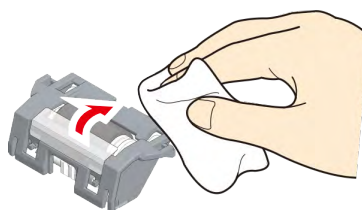

- 10** Press down on the center of the MP tray until the left trapezoidal part of the separation roller cover fits into the groove on the machine.

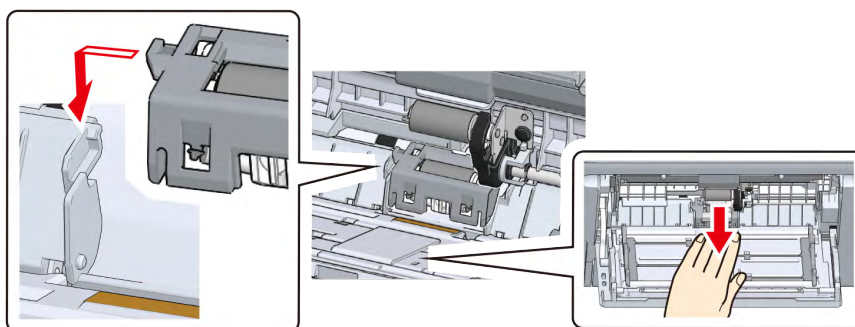

- 11** Ensure that the separation roller is in a horizontal position, and then push both ends of the separation roller cover down at the same time.



- Do not touch the rubber portion of the roller.

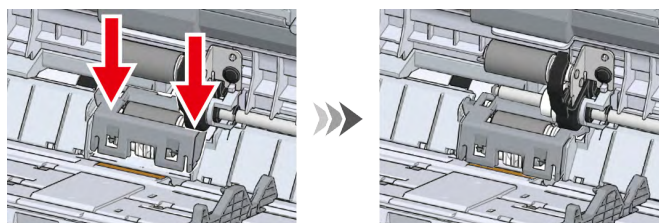

- 12** Press down on the center of the MP tray, and then press and hold the white part which is visible through the small window at the bottom of the separation roller cover. With the protrusion side on the left, install the paper feed roller (without gear) onto the lower shaft by sliding it into the innermost position.

If it is hard to insert, slide to install the paper feed roller (without gear) while rotating it downward.

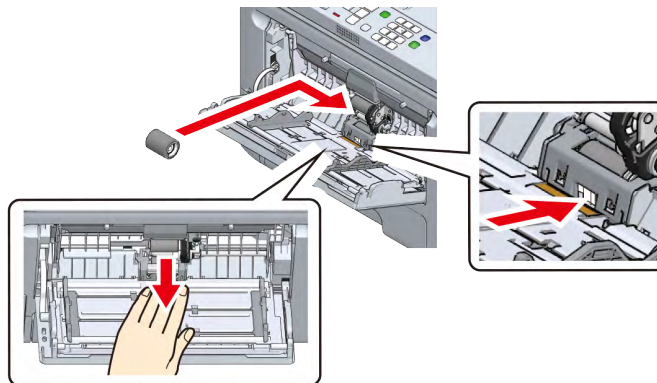

- 13** Wipe the paper feed roller (without gear, with gear) with a cloth slightly moistened with water.



- If it is hard to wipe the paper feed roller (without gear), wipe it while pressing down on the center of the MP tray and then pushing the white part which is visible through the small window at the bottom of the separation roller cover.

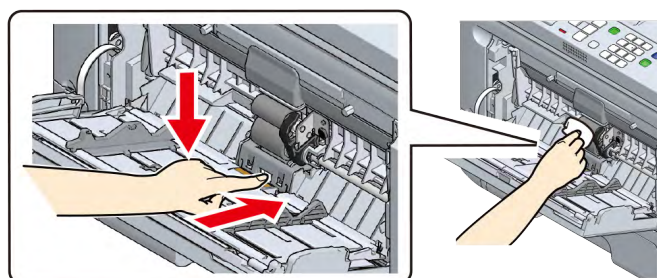

- 14** Move the paper placement cover downward.

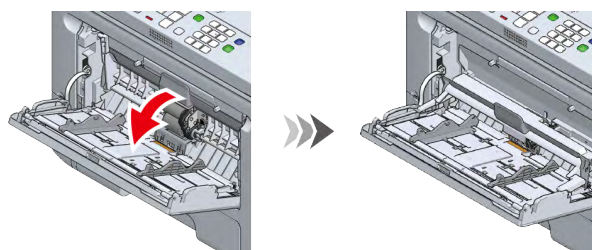

- 15** While pressing the right arm of the MP tray inwards, lift the MP tray lightly and hook the protrusion of the arm into the groove.



- If you close the MP tray without hooking the protrusion of the arm to the correct position, the paper placement cover may be broken. Be sure to hook it in the correct position.

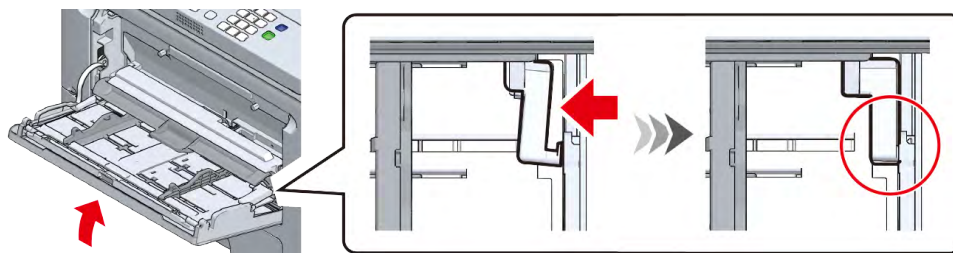

- 16** Similarly, hook the protrusion of the left arm of the MP tray into the groove.



- If you close the MP tray without hooking the protrusion of the arm to the correct position, the paper placement cover may be broken. Be sure to hook it in the correct position.

- 17** Slide the manual feeder guide outward.

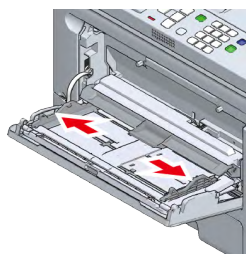

- 18** Close the MP tray.

If the MP tray does not close, check by following Steps 14 through 17.

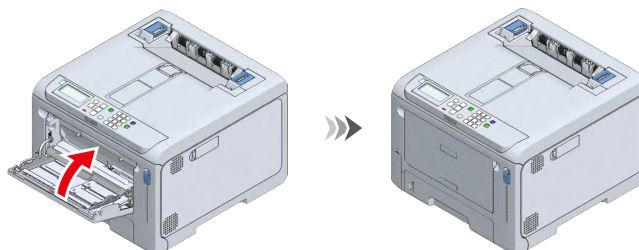

Cleaning the light-shielding film

When streaks appear on the printing result, clean the light-shielding film of the image drum to improve the printing.

- 1** Remove the black(K) image drum from this machine.
[Replacing the image drum\(P.303\)](#)
- 2** Make sure that the color label of the image drum is on the right side.
- 3** Wipe the light-shielding film with soft tissue paper.

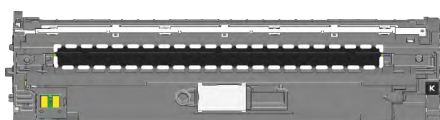

- 4 Install the image drum to this machine.
[Replacing the image drum\(P.303\)](#)
- 5 Clean the light-shielding film of other image drums as well.

Cleaning the resist roller

When horizontal streaks appear on the printing result, clean the resist roller to improve the printing.

- 1 Pull the front cover open lever (blue) to open the front cover.

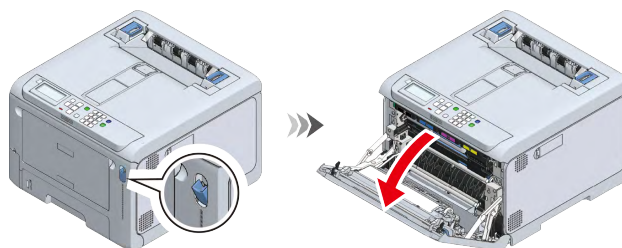

- 2 Wipe the metal parts (a) and (b) of the resist roller visible on the front with soft tissue paper.

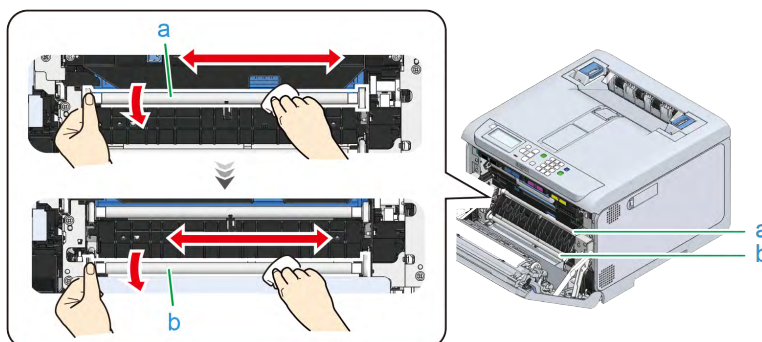

- When cleaning the metal part (b), do not touch the rubber roller in contact with the metal part (a).

- 3 Rotate the metal part downward, and repeat wiping until dirt is removed.
- 4 Close the front cover firmly with your both hands.

Updating software

You can update the printer driver and other software to the latest version.
A PC connected to the Internet is required for the update.

For Windows

For Windows, use the Monitoring Tool.

[Monitoring Tool \(Windows\)](#)(P.249)

For macOS

For macOS, please refer to the website.

Deleting software

This section explains how to delete the printer driver from your PC.



- The specific method may differ for different printer drivers and versions of Windows or macOS.

Uninstalling the Windows printer driver



- To perform this procedure, you will have to login to the PC as a user with administrator privileges.
- Restart the PC before uninstalling the printer driver.

1 Open the "Devices and Printers".

[How to open the printer folder](#) (P.142)

2 Right-click on the icon of the printer to be deleted, and select [Remove device].

3 When a confirmation message is displayed, click [Yes].



- If a message indicating that the device is being used is displayed, restart the PC and repeat Steps 1 and 2.

4 Select one of the icons in [Printers], and click [Print server properties] in the menu bar.

5 Select the [Drivers] tab.

6 Click [Change Driver Settings] if displayed.

7 Select the driver to be deleted, and click [Remove].

8 When a message asking whether to delete the printer driver only or the printer driver and package from the system, select [Remove driver and driver package], and click [OK].

9 When a confirmation message is displayed, click [Yes].

10 When the [Remove Driver Package] screen is displayed, click [Delete] - [OK].



- If deletion is rejected, restart the PC and repeat Steps 4 to 10.

11 Click [Close] in the [Print Server Properties] screen.

12 Restart the PC.

Uninstalling the macOS printer driver



- To perform this procedure, you will have to login to the PC as a user with administrator privileges.

1 Select [System Preferences] from the Apple menu.

2 Select [Printers & Scanners].

3 Select the device to be deleted, and click [-].

When a confirmation message is displayed, click [Delete Printer].



- If you cannot click [-], click the key mark.

4 Close the [Printers & Scanners] screen.

- 5 Insert the provided DVD to the PC.
- 6 Double-click on [OKI] - [Drivers] - [PS] - [Uninstaller].
- 7 Confirm the model to be deleted displayed in the dialog box, and click [OK].
- 8 Follow the on-screen instructions to delete the printer driver.
- 9 Once the deletion is complete, remove the included DVD from your computer.

Firmware update

You can update the printer firmware (device control program) to the latest version.
A PC connected to the Internet is required for the update.

For Windows

For Windows, use the Monitoring Tool.

[Monitoring Tool \(Windows\)](#)(P.249)

For macOS

For macOS, please refer to the website.

10 Troubleshooting

When an error message appears on the display	326
When paper is jammed	337
Trouble with printing	355
Troubleshooting for printing results	361
Software troubleshooting	373
Troubleshooting for this machine and paper	374

When an error message appears on the display

If a problem occurs to this machine, the ATTENTION lamp will light on or flash, and a message will appear on the display.

Check the message on the display and take action based on the corresponding message.

If [Please see HELP for details] appears at the bottom of the display, press «HELP» on the operator panel to show the solution. (If there is no indication, pressing «Help» will not change the indication on the display.)



- If a search keyword is displayed, you can search for a solution by inputting it in [Search Keyword] of "Frequently Asked Questions (FAQs)" on the website or your smartphone application.
- If a search keyword is displayed when the NFC function is enabled, the solution is displayed on this machine when the NFC mark on the operator panel is brought close to a device with the NFC function. Please see "[Showing troubleshooting tips on a mobile device](#)(P.291)" for details.

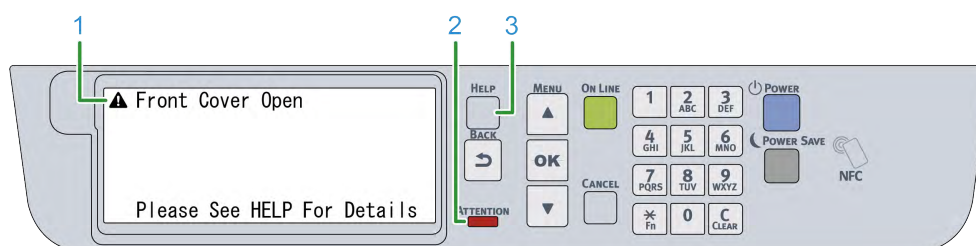

1	Display message
2	ATTENTION lamp
3	«HELP» button

Displayed when «HELP» is pressed

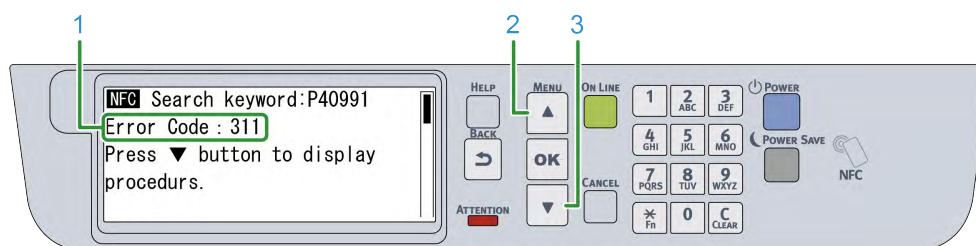

1	Error code
2	Scrolls up the display
3	Scrolls down the display

Error message list

Clear the error by referring to the description of the corresponding message.

Meanings of symbols used in the error message are as follows.

- **Color Name:** One of the following: cyan (C), magenta (M), yellow (Y), black (K)
- **Tray Name:** One of the following: Tray 1, Tray 2, Tray 3, Tray 4 and MP tray
- **Cover Name:** Either the front cover or the top cover (Output tray)
- **Code:** The error code number of 1 to 3 digits. The displayed number changes with the specific error.
- **Pages:** Number of pages to print
- **Media Size:** The size of paper
- **Media Type:** The type of paper
- **Number:** Number of all places where paper jams have occurred

For "---", different messages are displayed depending on the state of this machine.

When "Please see HELP for details" is displayed at the bottom of the display, if you press «HELP» on the operator panel, the error code and solution will be displayed.

Message	Error code	Description
Cover Name Open Please See HELP For Details	310, 311	The indicated cover is open. Close the cover. 310: Outlet tray (Top cover); 311: Front cover
Belt Unit Is Not Installed Correctly. Please Reset Please See HELP For Details	330	The belt unit is not properly installed. Please reinstall the belt unit. To install the belt unit, see " Replacing the belt unit(P.308) ".
Waste Toner Box Is Not Installed Correctly Because The Cover Is Open. Please Reset Please See HELP For Details	331	The waste toner box is not properly installed. Please reinstall the waste toner box. To replace the waste toner box, see " Replacing the black(K) toner cartridge and the waste toner box(P.298) ".
Toner Cartridge Is Not Installed Check All Toner Cartridges Are Installed Correctly. Please See HELP For Details	335	One of the four color toner cartridges is not properly installed. Please reinstall the toner cartridge that is not properly installed. To install the toner cartridge, see " Replacing the black(K) toner cartridge and the waste toner box(P.298) " or " Replacing the toner cartridge (C/M/Y)(P.301) ".
Color Name Image Drum Is Not Installed Correctly. Please Reset Please See HELP For Details	340, 341, 342, 343	The image drum of the displayed color is not properly installed. Please reinstall the image drum. To install the image drum, see " Replacing the image drum(P.303) ". 340: Yellow; 341: Magenta; 342: Cyan; 343: Black
Fuser Unit Is Not Installed Correctly. Please Reset Please See HELP For Details	320	The fuser unit is not properly installed. Please reinstall the fuser unit. To install the fuser unit, see " Replacing the fuser unit(P.310) ". If the error persists, replace the fuser unit with a new one.
Fuser Unit Is Not Installed Correctly. Reset Fuser Unit Please See HELP For Details	348	The fuser unit is not properly installed. Please reinstall the fuser unit. To install the fuser unit, see " Replacing the fuser unit(P.310) ". If the error persists, replace the fuser unit with a new one.
Color Name Image Drum End Of Life. Replace With A New Color Name Image Drum Please See HELP For Details	350, 351, 352, 353	The image drum of the displayed color has reached the end of its service life. You can continue printing for a while by opening and closing the front cover, but please replace the image drum with a new one promptly. To replace the image drum, see " Replacing the image drum(P.303) ". 350: Yellow; 351: Magenta; 352: Cyan; 353: Black

Message	Error code	Description
Fuser Unit End Of Life. Replace With A New Fuser Unit Please See HELP For Details	354	The fuser unit has reached the end of its service life. Please replace the fuser unit with a new one. You can continue printing for a while by opening and closing the front cover. To replace the fuser unit, see " Replacing the fuser unit(P.310) ".
Belt Unit End Of Life. Replace With A New Belt Unit Please See HELP For Details	355	The belt unit has reached the end of its service life. Please replace the belt unit with a new one. You can continue printing for a while by opening and closing the front cover. To replace the belt unit, see " Replacing the belt unit(P.308) ".
Belt Unit End Of Life. Replace With A New Belt Unit Please See HELP For Details	356	The waste toner area of the belt unit is full. Please replace the belt unit with a new one. To replace the belt unit, see " Replacing the belt unit(P.308) ".
Waste Toner Full. Install New Waste Toner Box Please See HELP For Details	357	See " Replacing the black(K) toner cartridge and the waste toner box(P.298) ".
Waste Toner Transfer Error. Please Reset Waste Toner Box Please See HELP For Details	359	See " Replacing the black(K) toner cartridge and the waste toner box(P.298) ".
Paper Size Error. Reset Paper In Tray Name Please See HELP For Details	400	Multiple sheets of paper are fed at a time from the displayed tray. Or, the paper of a size different from the paper size setting of the tray is fed. Remove the jammed paper. Remove the paper temporarily from the tray when multiple sheets of paper are fed at a time. Shuffle the paper well, horizontally align the edge of paper, and load the paper in the tray again. Otherwise, check the size of paper to print on and the paper size setting of the tray, and match the paper settings.
Multiple Sheets Of Paper Have Been Fed. Reset Paper In Tray Name Please See HELP For Details	401	Multiple sheets of paper are fed at a time from the displayed tray. Or, the paper of a size different from the paper size setting of the tray is fed. Remove the jammed paper. Remove the paper temporarily from the tray when multiple sheets of paper are fed at a time. Shuffle the paper well, horizontally align the edge of paper, and load the paper in the tray again. If overlapping paper is not fed, check the size of the paper to print on and the paper size setting of the tray, and match the paper settings.
Printing Stopped Because The Rear Output Tray Is Opened During The Printing Job. Please Remove Paper Please See HELP For Details	409	Open the front cover, and remove the paper left in the machine if any. Then, close the front cover.
Rear Output Tray Open. Duplex Not Available Please See HELP For Details	581	Please close the rear output tray.
Color Name Toner Is Empty Replace With A New Toner Cartridge. Please See HELP For Details	410, 411, 412	The toner of the displayed color is empty. You can continue using the device for a while by opening and closing the front cover, but the image drum may be damaged. Therefore, please replace the toner cartridge with a new one promptly. To replace the toner cartridge, see " Replacing the toner cartridge (C/M/Y)(P.301) ". 410: Yellow; 411: Magenta; 412: Cyan

Message	Error code	Description
Black(K)Toner Is Empty Replace With A New Toner Cartridge And A New Waste Toner Box At The Same Time. Please See HELP For Details	413	The black (K) toner is empty. You can continue using the device for a while by opening and closing the front cover, but the image drum may be damaged. Therefore, please replace the toner cartridge with a new one promptly. To replace the toner cartridge, see " Replacing the black(K) toner cartridge and the waste toner box(P.298) ".
Check That The Waste Toner Box Has Been Replaced, And Press OK Please See HELP For Details	418	If you have not replaced the waste toner box, press «OK». If you have already replaced it, just press «OK».
Press OK After Replacing The Black(K) Toner Cartridge Please See HELP For Details	428	Replace the black(K) toner and press «OK».
Printing Data Is Large. Memory Is Not Enough Press OK To Hide This Message. Please See HELP For Details	420	The memory is insufficient. Print again after lowering the printing quality in the printer driver.
No Cassette In Tray Name . Remove The Tray And Re-insert Please See HELP For Details	430, 431, 432, 433, 440, 441, 442	The printing has stopped because the displayed paper cassette is not properly installed. Pull the paper cassette out, and insert it back. 430, 440: Tray 1; 431, 441: Tray 2; 432, 442: Tray 3; 433: Tray4
Data (Media Size, Media Type) Doesn't Match Paper In Tray Name Press OK To Continue Printing. Please See HELP For Details	460, 461, 462, 463, 464	The size of paper loaded in the displayed tray does not match the size of paper you are trying to print on. Check the paper size settings of the application you are trying to print from and the paper size settings of the tray, and match the paper size settings. If the paper size can be loaded in portrait/landscape, please note the vertical/horizontal orientation. 460: MP tray; 461: Tray 1; 462: Tray 2; 463: Tray 3; 464: Tray 4
No Paper In Tray Name . Set Media Size Please See HELP For Details	490	There is no paper in the indicated tray. Please load paper. 490: MP tray
No Paper In Tray Name . Set Media Size . Please See HELP For Details	491, 492, 493, 494	There is no paper in the indicated tray. Please load paper. 491: Tray 1; 492: Tray 2; 493: Tray 3; 494: Tray 4
Wireless Settings Are Incomplete Press OK To Hide This Message. Please See HELP For Details	505	The wireless LAN settings are not correct. Please reset the wireless LAN from the beginning. For details, see " Connecting via a wireless LAN(P.41) ". If the problem still persists, initialize the network settings and reset the wireless LAN settings. To initialize the network settings, see " Initializing network settings(P.237) ".
Not Connected To Wireless Access Point Press OK To Hide This Message. Please See HELP For Details	506	Not connected to the wireless LAN access point. Or, the wireless communication may be poor. Check that the power of the wireless LAN access point is turned on. Check that the wireless LAN settings are correct. For details, see " Connecting via a wireless LAN(P.41) ".

Message	Error code	Description
Wireless Startup Failed Press OK To Hide This Message. Please See HELP For Details	517	Restart this machine. If the problem still persists even after the reboot, power off this machine and check that the model name of the wireless LAN module is applicable to this machine. If the model name is incorrect, replace the wireless LAN module with the one suitable for this machine. If the model name is correct, consult your dealer.
Receiving Data Timeout Press OK To Hide This Message. Please See HELP For Details	519	The data could not be received within the correct time. When the print result is not as good as expected, extend the time for network timeout. The factory default setting is 90 seconds. Press the scroll buttons on the operator panel several times to change the settings in [Menus] - [System Setup] - [Timeout InJob].
Image Drum Sensor Error. Check And Reset Color Name Image Drum Please See HELP For Details	540, 541, 542, 543	A sensor error has occurred to the image drum of the indicated color. Please reinstall the image drum. To install the image drum, see " Replacing the image drum(P.303) ". If the error persists, contact your dealer. 540: Yellow; 541: Magenta; 542: Cyan; 543: Black
Color Name Toner Cartridge Is Not Installed Correctly Reset It Correctly. Please See HELP For Details	544, 545, 546, 547	The toner cartridge of the displayed color is not installed properly. Reinstall the toner cartridge. To install the toner cartridge, see " Replacing the black(K) toner cartridge and the waste toner box(P.298) " or " Replacing the toner cartridge (C/M/Y)(P.301) ". 544: Yellow; 545: Magenta; 546: Cyan; 547: Black
Color Name Toner Cartridge Is Not Installed Correctly Reset It Correctly. Please See HELP For Details The above message has been displayed multiple times.	544	Change the settings to the following: Moisture Control: Mode 2; Quiet Mode: On. To print with low toner consumption, please restore the settings. (The factory default settings are as follows: Moisture Control: Off; Quiet Mode: Off)
Color Name Image Drum End Of Life. Replace With A New Color Name Image Drum Please See HELP For Details	560, 561, 562, 563	The image drum of the displayed color has reached the end of its service life. Please replace the image drum with a new one. To replace the image drum, see " Replacing the image drum(P.303) ". 560: Yellow; 561: Magenta; 562: Cyan; 563: Black
Color Name Image Drum End Of Life. Replace With A New Color Name Image Drum Press OK to ignore service life and continue printing. Please See HELP For Details	564, 565, 566, 567	The image drum of the displayed color has reached the end of its service life. Please replace the image drum with a new one. You can continue printing for a while by pressing «OK» on the operator panel, but the print quality is not guaranteed. To replace the image drum, see " Replacing the image drum(P.303) ". 564: Yellow; 565: Magenta; 566: Cyan; 567: Black
Fuser Unit Is Not Installed Correctly. Or The Handle Of Fuser Is In Standing Position Please See HELP For Details	582	The fuser unit is not properly installed. Or, the handle of the fuser unit is not locked. Please reinstall the fuser unit. To install the fuser unit, see " Replacing the fuser unit(P.310) ".
Color Name Toner Cartridge Is Not Installed Please See HELP For Details	610, 611, 612, 613	The toner cartridge of the displayed color is not installed. Install the toner cartridge. To install the toner cartridge, see " Replacing the black(K) toner cartridge and the waste toner box(P.298) " or " Replacing the toner cartridge (C/M/Y)(P.301) ". 610: Yellow; 611: Magenta; 612: Cyan; 613: Black

Message	Error code	Description
Non Recommended Color Name Toner Please See HELP For Details	549, 550, 551, 552, 553, 554, 555, 556, 557, 614, 615, 616, 617, 620, 621, 622, 623	The toner cartridge of the displayed color is not optimal for this machine. It is recommended to use the toner cartridge that is optimal for this machine. 550, 554, 614, 620: Yellow; 551, 555, 615, 621: Magenta; 552, 556, 616, 622: Cyan; 549, 553, 557, 617, 623: Black
Paper Jam Occurred. Paper Jam Number Place(s). Remove The Paper Please See HELP For Details	370, 371, 372, 380, 381, 382, 385, 390, 391, 392, 393, 394, 638	A paper jam has occurred. Multiple sheets of paper remain inside this machine. When the scroll button on the operator panel is pressed, the lamp for the place where paper is jammed blinks. Remove all the paper from where the lamp blinks. For how to clear paper jams, see " When paper is jammed(P.337) ".
Please Change Paper In MPTray Media Size Media Type Press OK To Start Printing. Please See HELP For Details	660	The paper loaded in the MP tray does not match the paper you are trying to print on. Check the paper settings of the application you are trying to print from and the paper settings of the MP tray, and match the paper settings.
Please Change Paper In Tray Name Confirm Media Size, Media Type Is Set And Then Press OK. Please See HELP For Details	661, 662, 663, 664	The paper loaded in the displayed tray does not match the paper you are trying to print on. Check the paper settings of the application you are trying to print from and the paper settings of the tray, and match the paper settings. 661: Tray 1; 662: Tray 2; 663: Tray 3; 664: Tray 4
Printing Stopped Because Color Name Image Drum End Of Life. Replace With A New Color Name Image Drum Please See HELP For Details	680, 681, 682, 683	The printing has stopped because the image drum of the displayed color has reached the end of its service life. Please replace the image drum with a new one. To replace the image drum, see " Replacing the image drum(P.303) ". 680: Yellow; 681: Magenta; 682: Cyan; 683: Black
Non Recommended Belt Unit Please See HELP For Details	688-01, 688-02, 688-03, 688-04	The belt unit is not optimal for this machine. It is recommended to use the belt unit that is optimal for this machine.
Belt Unit Not Installed Please See HELP For Details	689	The belt unit is not properly installed. Remove the belt unit and install it properly. To replace the belt unit, see " Replacing the belt unit(P.308) ".
Color Name Image Drum Is Not Installed Please See HELP For Details	694, 695, 696, 697	The image drum of the displayed color is not properly installed. Please reinstall the image drum. To install the image drum, see " Replacing the image drum(P.303) ". 694: Yellow; 695: Magenta; 696: Cyan; 697: Black
Non Recommended Fuser Unit Please See HELP For Details	698-01, 698-02, 698-03, 698-04, 698-07	The fuser unit is not optimal for this machine. It is recommended to use the fuser unit that is optimal for this machine.
Fuser Unit Not Installed Please See HELP For Details	699	The fuser unit is not properly installed in this machine. Please reinstall the fuser unit. To replace the fuser unit, see " Replacing the fuser unit(P.310) ".
Non Recommended Color Name Image Drum Please See HELP For Details	684, 685, 686, 687, 690, 691, 692, 693, 700, 701, 702, 703, 704, 705, 706, 707	The image drum of the displayed color is not optimal for this machine. It is recommended to use the image drum that is optimal for this machine. 684, 690, 700, 704: Yellow; 685, 691, 701, 705: Magenta; 686, 692, 702, 706: Cyan; 687, 693, 703, 707: Black

Message	Error code	Description
Caution: Non-Genuine consumable detected. Check User's Manual "Trouble Shooting" to restore machine operation	709	You can use any consumables/maintenance parts, but the print quality may be lowered and the optimum performance may not be obtained. If the use of non-genuine consumables/maintenance parts causes damage to the product or results in your product not functioning to its full specification, such damage or effects on the product are not covered by warranty. When you understand the above points and use non-genuine consumables/maintenance parts, follow the procedure below. 1. Power off the main unit. 2. Power on this machine while pressing «CANCEL» on the operator panel. 3. When [Ready To Print] appears, release «CANCEL». The above operation will be recorded inside this machine.
Error While Initializing Settings Press OK To Hide This Message	751	The initial value set with the NFC Setting Tool is not properly reflected in the device settings. Please check a setting value.
Power Off and Wait for a while. 126:Condensing Error	Fatal 126	Condensation has occurred inside this machine. Turn off the power, and then turn the power back on after a while. If the same error message is displayed, contact your dealer.
Recovered from the error nnn Print again if the printing result does not come as expected Press OK To Hide This Message	-	An error has occurred inside this machine, and the machine has restarted. Check that the print result comes as expected, since the machine may restart during printing. Print again if the printing result does not come as expected.
Service Call nnn:Error	-	An error has occurred inside this machine. Please contact your dealer.
Communication Error	-	An error has occurred in this machine. Restart this machine. If the error persists, contact your dealer.
Detected An Abnormality Of Internal Database The Data Must Be Deleted After Pressing [OK], The Data Will Be Deleted, And Then Reboot	-	An error has occurred in the internal database of this machine. Press «OK» on the operator panel to delete the database and restart this machine.
Language Change Failed. Error num: Code	-	Failed to change the display language on the display. Restart this machine, and reset the language setting.
Firmware Update Error. Perform Firmware Update Again If The Same Error Message Appears, Please Contact Our Customer Service Center	-	Firmware update has failed. Please update the firmware again. For details, see " Firmware update (P.324)".
PU Flash Error	-	An error has occurred in this machine. Please contact your dealer.
Memory Is Not Enough. Please Reduce Resolution Or Finish The Function Press OK To Hide This Message	-	The memory is insufficient. Print again after lowering the printing quality in the printer driver.
Manual Printing. Set Media Size In MPTray Press OK To Start Printing	-	The print mode has been specified in which paper is loaded in the MP tray and fed one by one. Load proper paper in the MP tray, and press «OK» on the operator panel. If you are printing a multi-page document, the same message appears each time after one page is printed. Press «OK» each time.

Message	Error code	Description
Install New Image Drum. For Maximum Performance Always Use OKI Original	-	The image drum of the displayed color has reached the end of its service life. Please replace the image drum with a new one. It is recommended to use the image drum that is optimal for this machine.
Color Name Toner Empty. For Maximum Performance Always Use OKI Original.	-	The toner of the displayed color is empty. Please replace the toner cartridge with a new one. It is recommended to use the toner cartridge that is optimal for this machine.
--- Can Not Read The File Press OK To Hide This Message	-	Canceled because the USB memory is unplugged during printing from the USB memory. To print it again, plug the USB memory in this machine.
--- Color Name Image Drum Sensor Error. Search Keyword: P40959	-	The image drum of the displayed color is not properly installed in this machine. Please reinstall the image drum of the displayed color.
--- Color Name Image Drum Near Life. Search Keyword: P10076	-	The image drum is approaching its service life. Please prepare a new image drum. After the message of replacement is displayed, please replace it with a new one.
--- Color Name Image Drum Life. Print Quality Not Guaranteed. Search Keyword: P40936	-	The image drum of the displayed color has reached the end of its service life. Print quality is not guaranteed. Please replace the image drum with a new one as soon as possible. To replace the image drum, see " Replacing the image drum(P.303) ".
--- Color Name Image Drum Life. Search Keyword: P40936	-	The image drum of the displayed color has reached the end of its service life. Please replace the image drum with a new one. To replace the image drum, see " Replacing the image drum(P.303) ".
--- Color Name Image Drum Life. Pages Pages Left. Search Keyword: P40936	-	The image drum of the displayed color has reached the end of its service life. Unable to print after the displayed number of pages. Please replace the image drum with a new one as soon as possible. To replace the image drum, see " Replacing the image drum(P.303) ".
--- Color Name Toner Not Installed. Search Keyword: P40902	-	The toner cartridge of the displayed color is not installed. Please install the toner cartridge. To install the toner cartridge, see " Replacing the black(K) toner cartridge and the waste toner box(P.298) " or " Replacing the toner cartridge (C/M/Y)(P.301) ".
--- Color Name Toner Empty. Search Keyword: P40028	-	The toner of the displayed color is empty. Please replace the toner cartridge with a new one.
--- Replace The black(K) Toner Cartridge And Waste Toner Box At The Same Time. Search Keyword: P40028	-	The black(K) toner is empty. Replace the black(K) toner cartridge and the waste toner box with new ones.
--- Color Name Toner Empty. Search Keyword: P40028	-	The toner of the displayed color is empty. Please replace the toner cartridge with a new one.
--- Color Name Toner Low. Search Keyword: P10081	-	The toner of the displayed color is low. Please prepare a new toner cartridge. After the message of replacement is displayed, please replace it with a new one.
--- Tray Name Empty	-	There is no paper in the indicated tray. Please load paper.

Message	Error code	Description
--- Tray Name Cassette Missing	-	The displayed tray is not properly installed. Please install the tray.
--- E-mail Receiving Has Been Cancelled Press OK To Hide This Message	-	The e-mail printing is canceled. The file attached to the e-mail is canceled under the following conditions. 1. The format is not PDF, JPEG or TIFF 2. No file is attached 3. The size exceeds 8 MB Check the file format and size of the attached file.
--- IPv4 Address Is Conflicted Change IPv4 Address	-	The IPv4 Address conflicts with that of another machine. Please change the IPv4 address.
--- Getting Target IP Failed. Please Check DHCP Settings	-	The DHCP server was not detected. Check that the DHCP server is connected to the same network of this machine.
--- Error PDF Press OK To Hide This Message	-	Unable to print because an error has occurred to the PDF file you tried to print. Print again by using the printer driver from the application.
--- PDF Cache Write Error Press OK To Hide This Message	-	Failed to cache the PDF file. Print again after increasing the free space of the flash memory.
--- PDL Error Occurred	-	A PDL error has occurred. Press «OK» to clear the error display.
--- No Communication With The SNTP Server	-	Failed to retrieve the time from the SNTP server. Press the scroll buttons on the operator panel several times to check that the setting of [SNTP server] is correct in [Admin Setup] - [Time Setup].
--- USB Hub Unsupported Please Detach It	-	A USB hub which is not applicable to this machine is connected. Please detach the USB hub.
--- Incompatible USB Device Connected Please Detach It	-	Failed to recognize the USB device. Please re-connect the USB device.
--- Color Toner Empty. Job Cancelled Press OK To Hide This Message	-	Printing of the received color data is canceled because the color toner is empty. Please replace the empty toner cartridge with a new one.
--- Color Restricted. Job Rejected Press OK To Hide This Message	-	The print data from an user unauthorized to print in color was deleted. To print in color, contact the administrator of this machine.
--- Color Restricted. Mono Printed Press OK To Hide This Message	-	The print data from an user unauthorized to print in color was printed in mono. To print in color, contact the administrator of this machine.
--- Color Name Non Recommended Image Drum Detected. Search Keyword: P40485	-	The image drum of the displayed color is not optimal for this machine. It is recommended to use the image drum that is optimal for this machine.
--- Color Name Non Recommended Toner Detected. Search Keyword: P40947	-	The toner cartridge of the displayed color is not optimal for this machine. It is recommended to use the toner cartridge that is optimal for this machine.
--- Non Recommended Belt Unit.Search Keyword: P40444	-	The belt unit is not optimal for this machine. It is recommended to use the belt unit that is optimal for this machine.

Message	Error code	Description
--- Non Recommended Fuser Unit. Search Keyword: P40439	-	The fuser unit is not optimal for this machine. It is recommended to use the fuser unit that is optimal for this machine.
--- Job Log Database Error Contact The Device Administrator Press OK To Hide This Message	-	A database access error has occurred to writing or reading of print data logs. Turn off this machine and then turn it back on. If the same error message is displayed again, contact your dealer.
--- Decode Error Occurred Press OK To Hide This Message	-	Unable to print because an error has occurred to the image data. Please check the image data.
--- Password Required To Print Press OK To Hide This Message	-	Printing restrictions have been imposed on the PDF file. Please input the password required to print.
--- Invalid Password Press OK To Hide This Message	-	Unable to print because the password set in the PDF file does not match the password you input. Please input the correct password.
--- File System Operation Failed <nnn> Press OK To Hide This Message	-	A file system error has occurred. Press «OK» on the operator panel to hide the message.
--- Belt Unit Near Life. Search Keyword: P10978	-	The belt unit is approaching the end of its service life. Please prepare a new belt unit. After the message of replacement is displayed, please replace it with a new one.
--- Change Belt Unit. Search Keyword: P40970	-	The belt unit has reached the end of its service life. Please replace the belt unit with a new one. To replace the belt unit, see " Replacing the belt unit (P.308)".
--- Error Postscript	-	An error has occurred to Postscript data. Please check the print result. If there is a problem with the print result, print again. The problem may be solved if you select [Optimize for Portability] in the Postscript output option of the PS printer driver.
--- Log Buffer Is Full. Job Rejected Press OK To Hide This Message	-	The print data was deleted because the log buffer is full. Please contact the printer administrator and delete the log.
--- Print Restricted. Job Rejected Press OK To Hide This Message	-	The print data from an user unauthorized to print was deleted. To print, contact the administrator of this machine.
--- Job Type Restricted Job Rejected Press OK To Hide This Message	-	The print data was canceled because only Private Print is enabled with restrictions. Select Private Print from Job Type in the printer driver. See " Printing with print data encrypted and password set (Private Print) (P.190)".
--- Expired Saved Files Have Been Deleted Press OK To Hide This Message	-	The private print document whose retention date has passed was deleted.
--- NFC Unit Error. NFC Function Is Not Available Press OK To Hide This Message	-	An error has occurred to the NFC unit. NFC-specific functions are not available. Power off/on this machine. You can hide this message by selecting [Disable] for [Admin Setup] - [Others Setup] - [NFC Setup].

Message	Error code	Description
--- Incompatible USB Device Connected Please Detach It	-	A USB device that is not supported by this machine is connected. Please detach the USB device.
--- Fuser Unit Near Life. Search Keyword: P10979	-	The fuser unit is approaching the end of its service life. Prepare a new fuser. After the message of replacement is displayed, please replace it with a new one.
--- Change Fuser Unit. Search Keyword: P40971	-	The fuser unit has reached the end of its service life. Please replace the fuser unit with a new one. To replace the fuser unit, see " Replacing the fuser unit(P.310) ".
--- Waste Toner Near Full. Search Keyword: P10949	-	The free space of the waste toner box is low. Please prepare a new waste toner box. After the message of replacement is displayed, please replace it with a new one.
--- Change Waste Toner Box. Search Keyword: P40942	-	The waste toner box is full. Please replace the waster toner box with a new one. For the method, see " Replacing the black(K) toner cartridge and the waste toner box(P.298) ".
--- Collate Fail:Too Many Pages Press OK To Hide This Message	-	The memory is full with the collation data. Reduce the number of pages of the print data.
--- Invalid Print Data Received Press OK To Hide This Message	-	If you were printing a private job, the data was deleted because it was not complete. Please print it again. Or, the received PLD command data is not supported. Please check the printer driver in use.
--- Duplex Print Failed Press OK To Hide This Message	-	Printed on one side because the paper setting is not applicable to duplex printing. To print on both sides, print again from the tray with paper suitable for duplex printing. For paper settings applicable to duplex printing, see " Applicable paper(P.72) ".
--- Wait Timeout Is Disabled	-	Timeout Injob is set to [Off]. When the USB cable is connected, you may not be able to print from the network.
Please Wait Executing Maintenance Please Do Not Power Off	-	Firmware update is in progress. If the power is turned off halfway, this machine may not be able to start. When update is completed, the machine restarts automatically.

When paper is jammed

For the error code 370 or 371

- 1 Remove the jammed paper from the output exit.

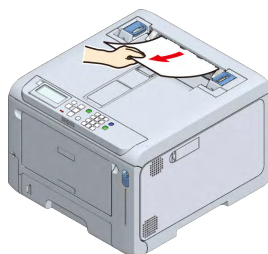

- 2 Pull the front cover open lever (blue) to open the front cover.

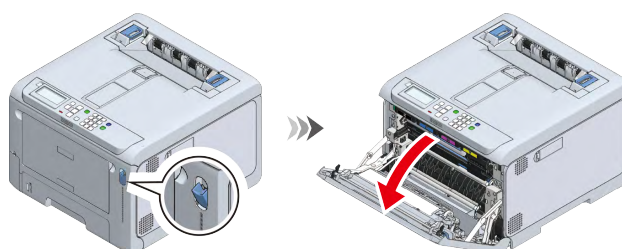

- 3 Pull the L2 lever and lift the output tray until it reaches the stop position.

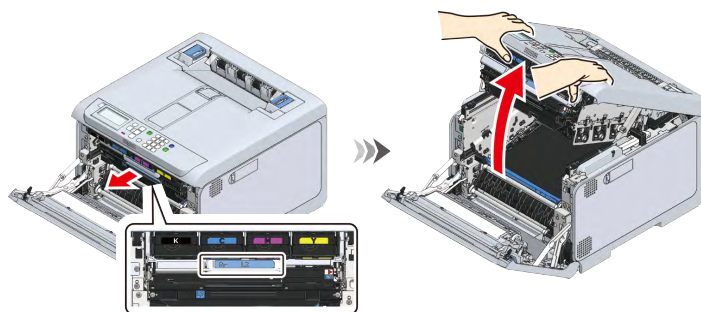

- 4 Remove the paper left on the belt unit if any.

CAUTION

Doing so may cause burns.



Do not touch the fuser unit because it is hot.



- Because image drums (green parts) can easily get damaged, handle with adequate care.
- Do not expose the image drum to direct sunlight or strong light (About 1,500 lux or above). Do not leave it uncovered for more than 5 minutes even under room lighting.

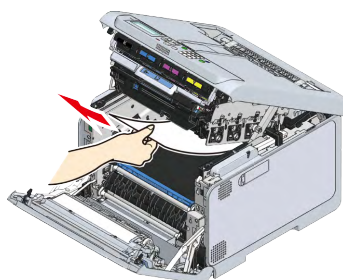

- 5 Lift the belt unit up by holding its handle.

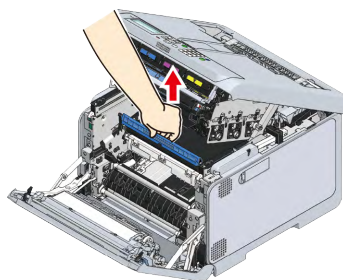

- 6 Remove the paper left under the belt unit if any.

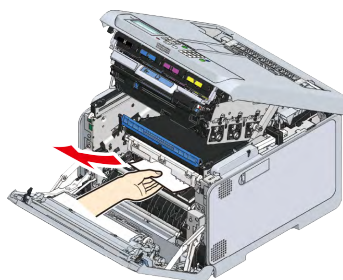

- 7 Reset the belt unit.

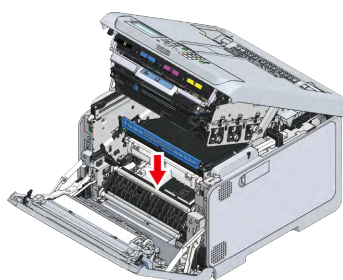

- 8 Close the output tray, and push both sides down from top.

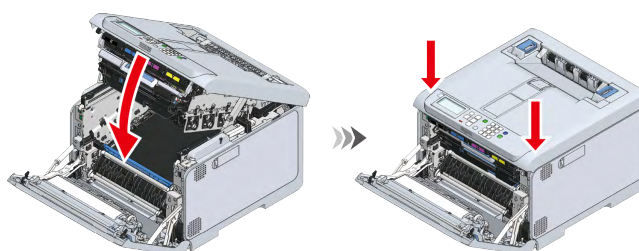



- 9 Lift the left and right handles of the fuser unit at the back of the output tray until a click is heard, and then release the lock.

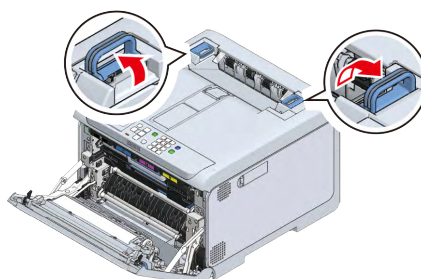

- The fuser unit cannot be removed unless its handle is raised vertically.



10 Remove the fuser unit from this machine by holding its left and right handles.

 CAUTION	Doing so may cause burns.	
When the fuser unit is hot, wait until it cools down before any operation.		



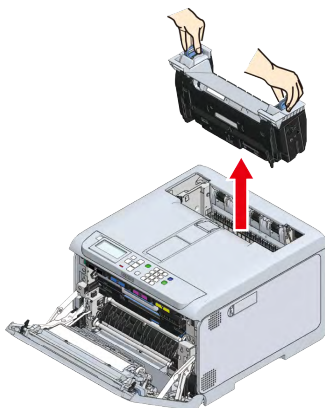

- Do not expose this machine with the fuser unit removed to direct sunlight or strong light (About 1,500 lux or above). Do not leave it uncovered for more than 5 minutes even under room lighting.

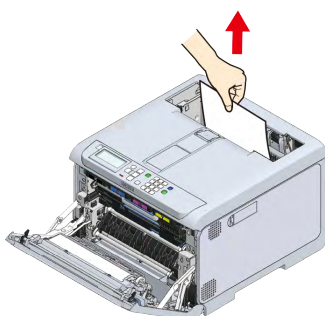

11 Remove any paper left in the machine.



12 If paper is jammed in the fuser unit, with the warning label of the fuser unit facing you, slowly pull out the jammed paper towards you.

 CAUTION	Doing so may cause burns.	
When the fuser unit is hot, wait until it cools down before any operation.		



- Do not pull it out in the reverse direction.

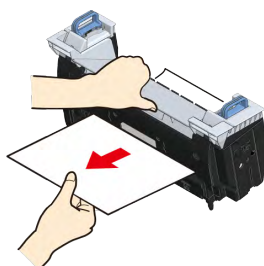

- 13** With the warning label of the fuser unit facing you, hold both the left and right handles.

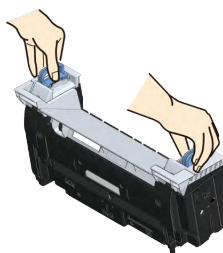

- 14** Place the fuser unit in this machine, tilt its left and right handles inward, and lock the fuser unit.



- Make sure that the fuser unit does not float from the top of the output tray. If floating, the fuser unit will not be recognized so that it is not possible to start printing.

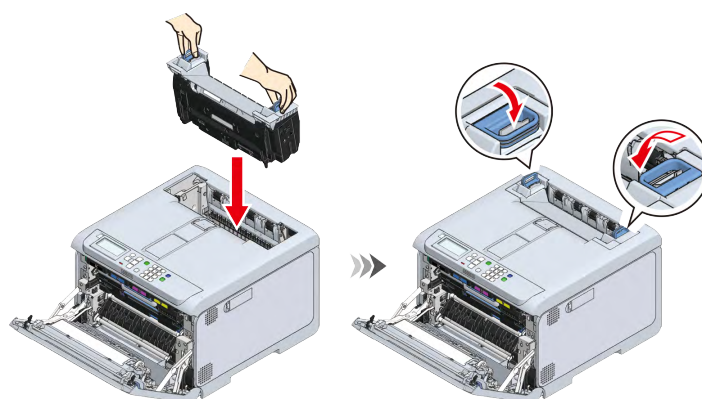

- 15** Close the front cover firmly with both hands.

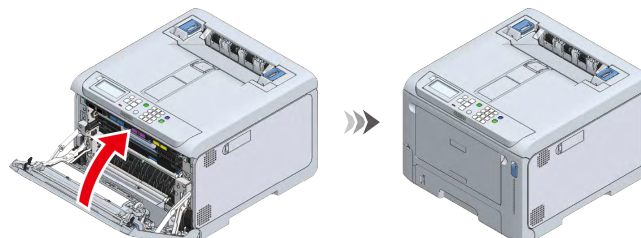

For the error code 372

- 1** Remove the jammed paper from the output exit.

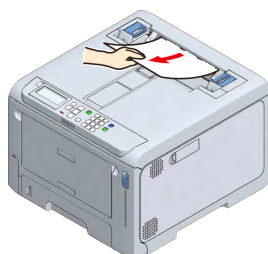

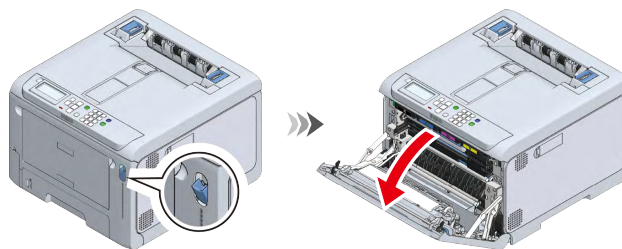

- 2 Pull the front cover open lever (blue) to open the front cover.

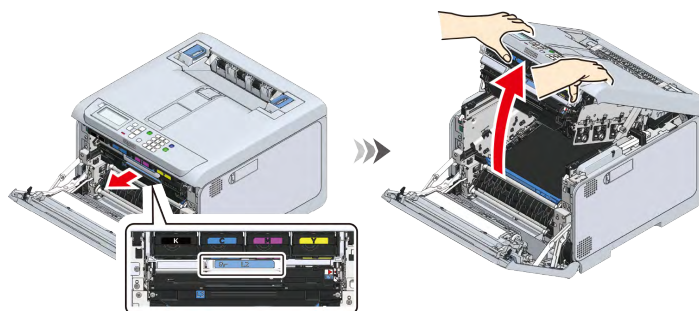

- 3 Pull the L2 lever and lift the output tray until it reaches the stop position.



- 4 Remove the paper left on the belt unit if any.

 CAUTION	Doing so may cause burns.	
Do not touch the fuser unit because it is hot.		



- Because image drums (green parts) can easily get damaged, handle with adequate care.
- Do not expose the image drum to direct sunlight or strong light (About 1,500 lux or above). Do not leave it uncovered for more than 5 minutes even under room lighting.

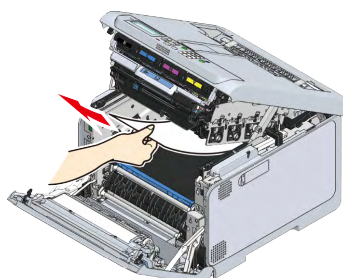

- 5 Lift the belt unit up by holding its handle.

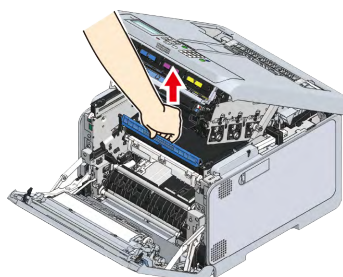

- 6** Remove the paper under the belt unit if any.

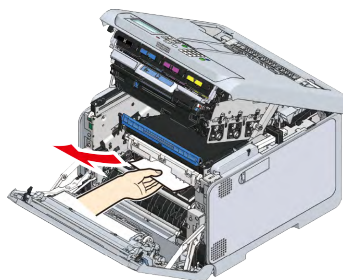

- 7** Reset the belt unit.

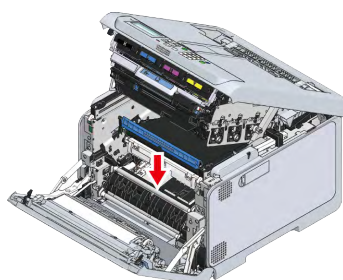

- 8** Close the output tray, and push both sides down from top.

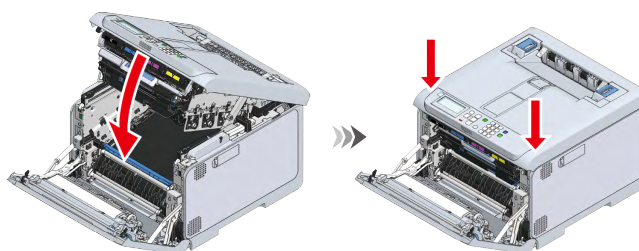

- 9** Close the front cover firmly with both hands.

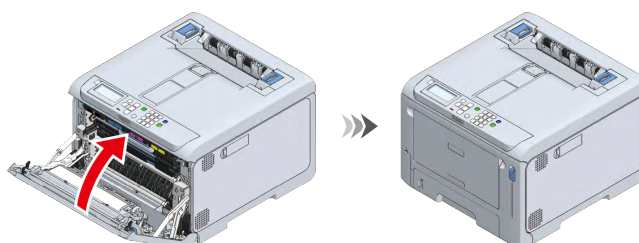

For the error code 380

- 1** Pull the front cover open lever (blue) to open the front cover.

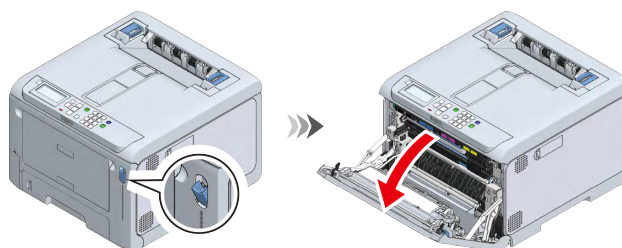

- 2 Pull out the jammed paper gently.

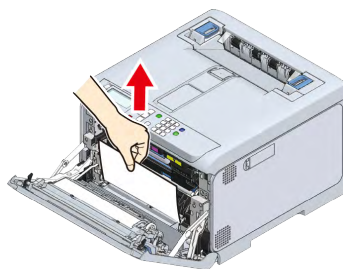

- 3 Close the front cover firmly with both hands.

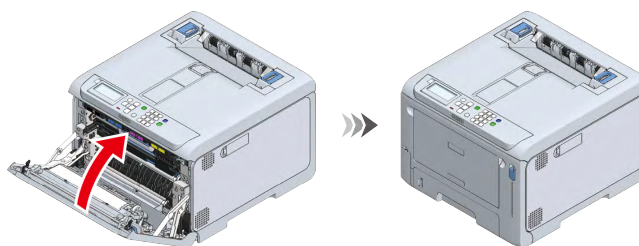

For the error code 381

- 1 Remove the jammed paper from the output exit.

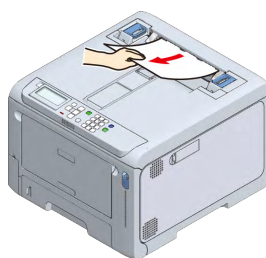

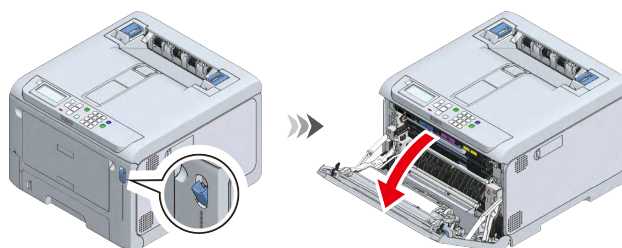

- 2 Pull the front cover open lever (blue) to open the front cover.

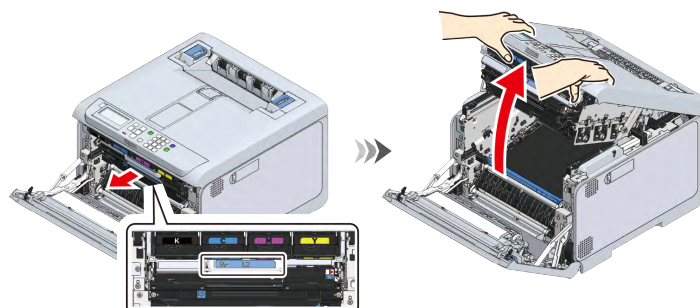

- 3 Pull the L2 lever and lift the output tray until it reaches the stop position.



4 Remove the paper on the belt unit if any.

 CAUTION	Doing so may cause burns.	
Do not touch the fuser unit because it is hot.		



- Because image drums (green parts) can easily get damaged, handle with adequate care.
- Do not expose the image drum to direct sunlight or strong light (About 1,500 lux or above). Do not leave it uncovered for more than 5 minutes even under room lighting.

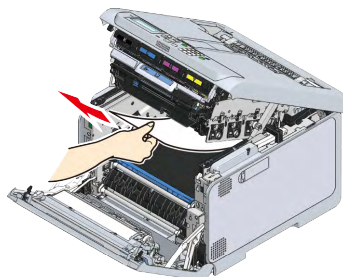

5 Close the output tray, and push both sides down from top.

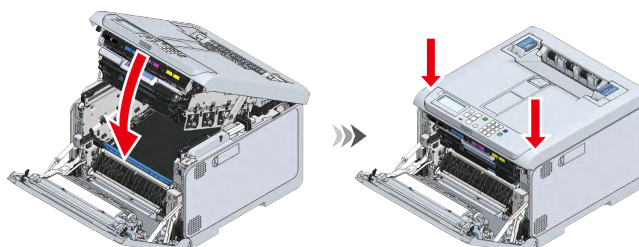

6 Close the front cover firmly with both hands.

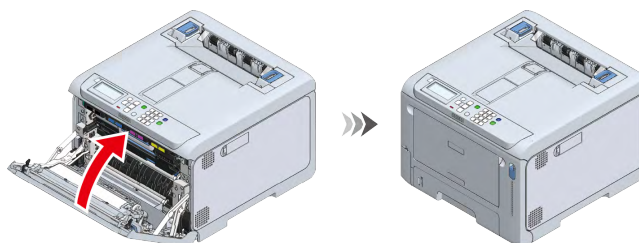

For the error code 382 or 385

1 Remove the jammed paper from the output exit.

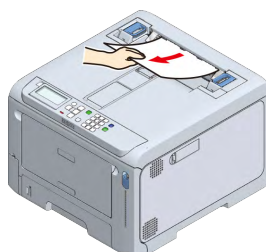

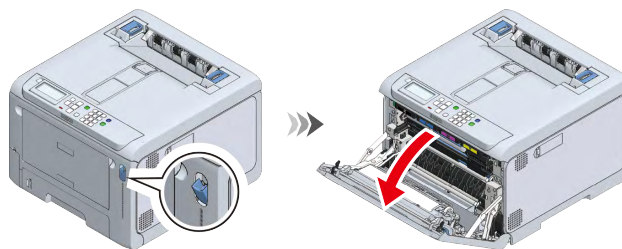

- 2 Pull the front cover open lever (blue) to open the front cover.

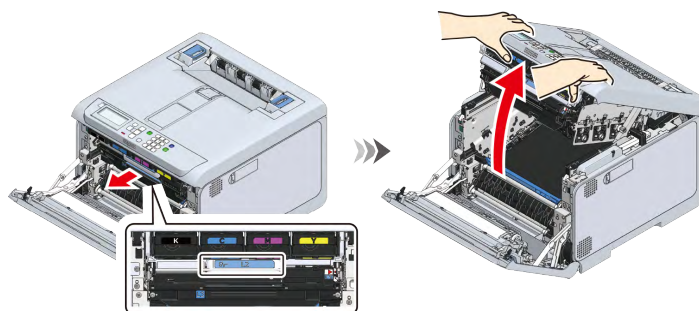

- 3 Pull the L2 lever and lift the output tray until it reaches the stop position.



- 4 Remove the paper left on the belt unit if any.

 CAUTION	Doing so may cause burns.	
Do not touch the fuser unit because it is hot.		



- Because image drums (green parts) can easily get damaged, handle with adequate care.
- Do not expose the image drum to direct sunlight or strong light (About 1,500 lux or above). Do not leave it uncovered for more than 5 minutes even under room lighting.

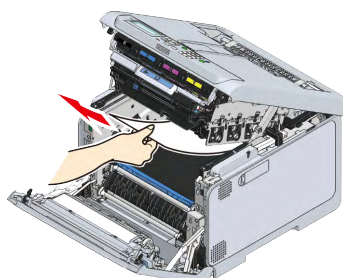

- 5 Close the output tray, and push both sides down from top.

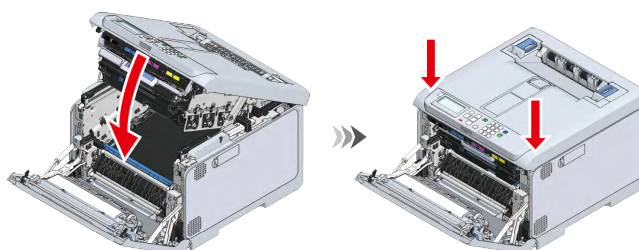

- 6 Lift the left and right handles of the fuser unit at the back of the output tray until a click is heard, and then release the lock.



- The fuser unit cannot be removed unless its handle is raised vertically.

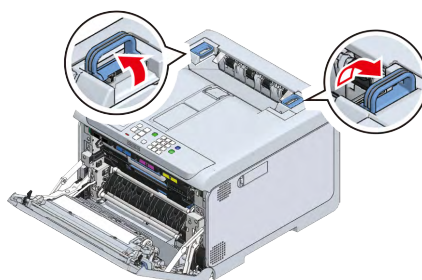

- 7 Holding both the left and right handles of the fuser unit, remove the fuser unit from this machine.

CAUTION	Doing so may cause burns.	
When the fuser unit is hot, wait until it cools down before any operation.		



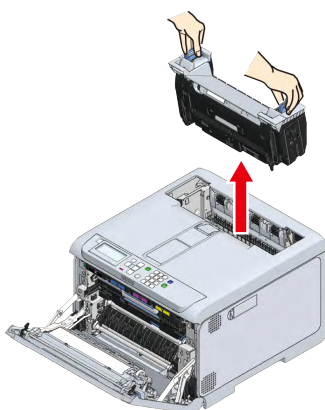

- Do not expose this machine with the fuser unit removed to direct sunlight or strong light (About 1,500 lux or above). Do not leave it uncovered for more than 5 minutes even under room lighting.

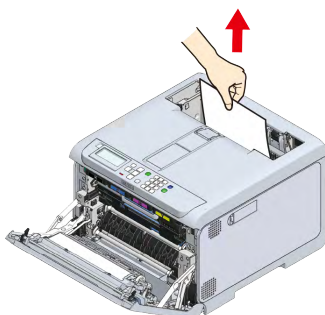

- 8 Remove any paper left in the machine.



- 9 If paper is jammed in the fuser unit, with the warning label of the fuser unit facing you, slowly pull out the jammed paper towards you.

 CAUTION	Doing so may cause burns.	
When the fuser unit is hot, wait until it cools down before any operation.		



- Do not pull out in the reverse direction.

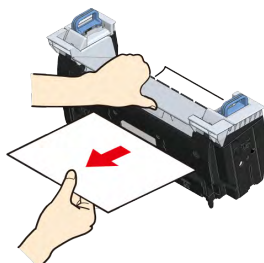

- 10 With the warning label of the fuser unit facing you, hold both the left and right handles.

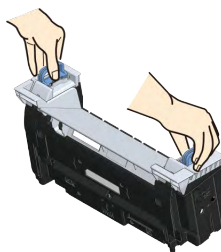

- 11 Place the fuser unit in this machine, tilt its left and right handles inward, and lock the fuser unit.



- Make sure that the fuser unit does not float from the top of the output tray. If floating, the fuser unit will not be recognized so that it is not possible to start printing.

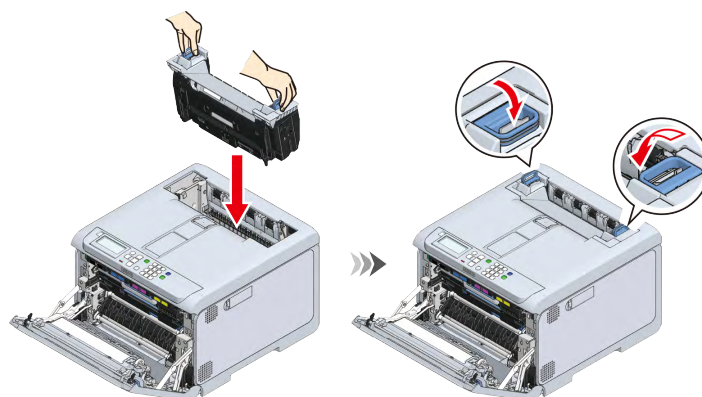

- 12 Close the front cover firmly with both hands.

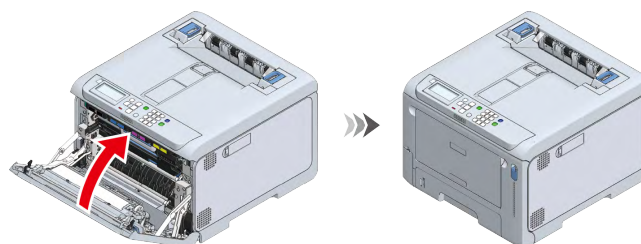

For the error code 390

- 1 Temporarily remove any paper loaded in the multi-purpose tray (MP tray).

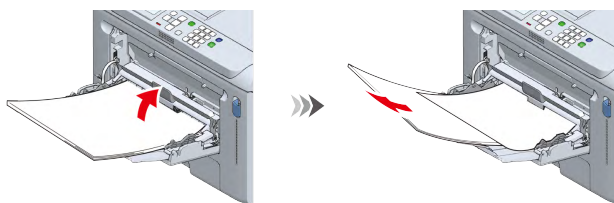

- 2 Pull the front cover open lever (blue) to open the front cover.

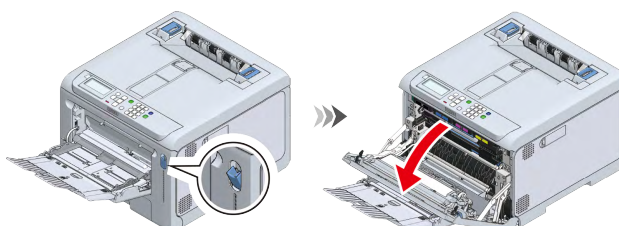

- 3 Hold the edge of the jammed paper and pull it out gently.

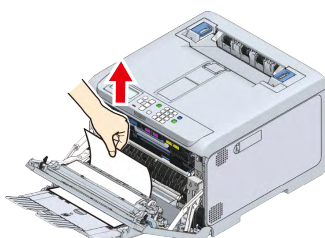

- 4 When the top edge is not visible, slowly pull out the paper from its rear edge.

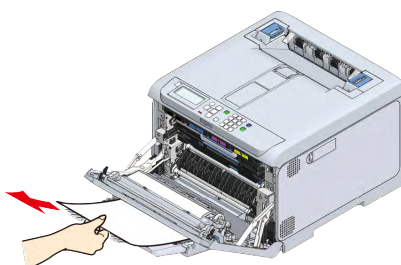

- 5 Close the front cover firmly with your both hands.

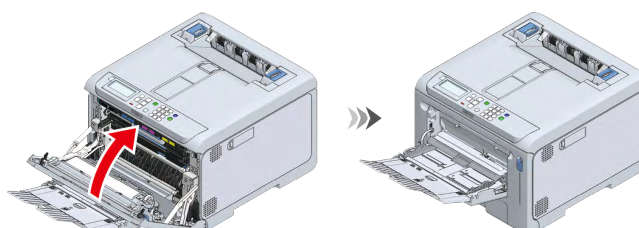

- 6 If you are using a MP tray, open the MP tray and load paper with the print side up.



- For how to load paper in the MP tray, see "[Loading paper in the MP tray\(P.80\)](#)".

For the error code 391, 392, 393 or 394

This section takes the error code 391 (indicating that the paper is jammed in Tray 1) for example. For the error code 392, 393 or 394, remove the jammed paper by following the same procedure.



- If paper jams occur frequently, clean the paper feed roller. Please see "[Cleaning paper feed rollers \(Trays 1-4\)\(P.314\)](#)" for details.

1 Pull out the paper cassette.

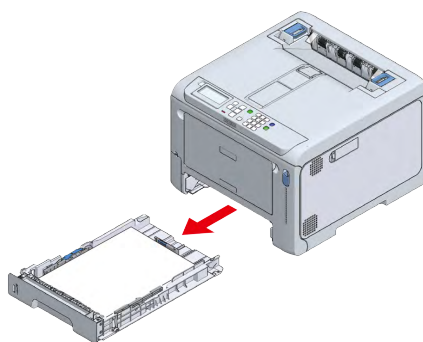

2 Remove the jammed paper.



- If no paper is jammed, feeding has failed. Reduce the number of paper loaded in the paper cassette. Also, make sure that the paper stopper position matches the paper size.

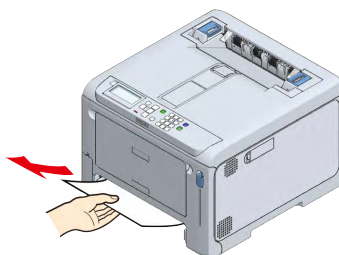

3 Return the paper cassette to this machine.

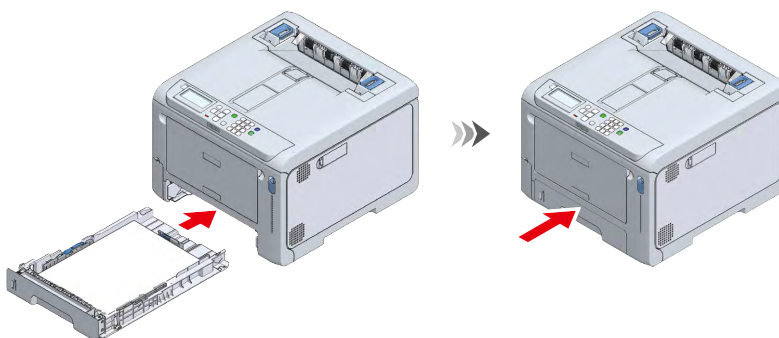

4 Open and close the front cover.



- Error cannot be cleared without opening and closing the front cover.

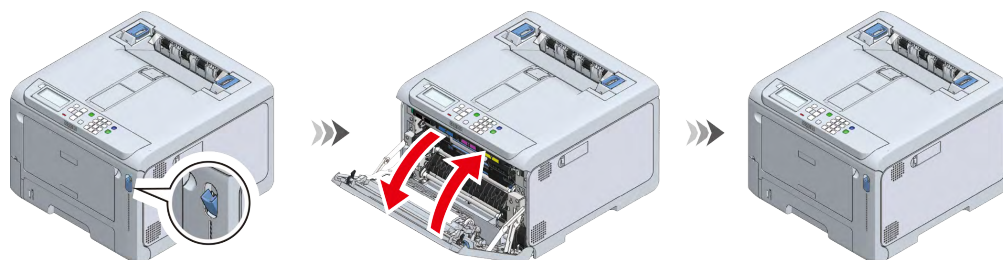

For the error code 638

First, check all the trays and remove the remaining paper. Then, remove the remaining paper inside the machine.

This section explains how to remove the paper from Tray 2 as an example.

1 Pull out the paper cassette.

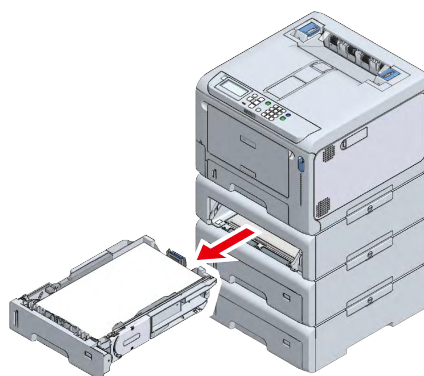

2 Remove the remaining paper.

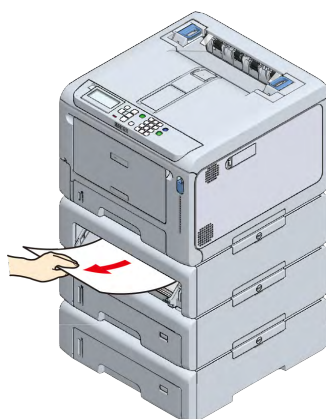

- 3** Return the paper cassette to this machine.

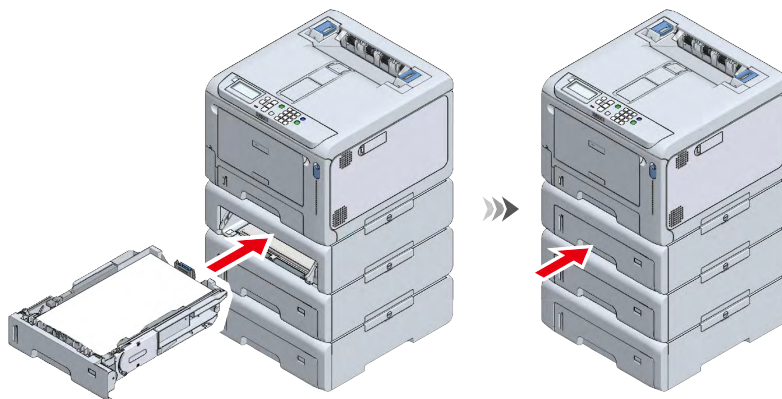

- 4** For all trays, repeat Steps 1 - 3 to remove the remaining paper.

- 5** Pull the front cover open lever (blue) to open the front cover.

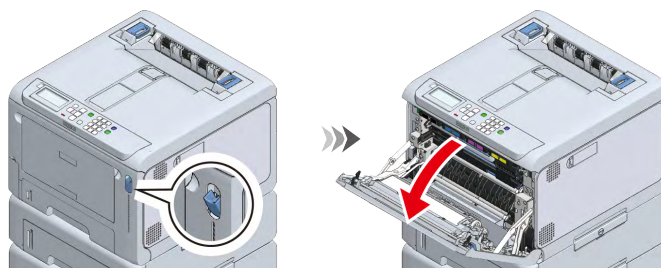

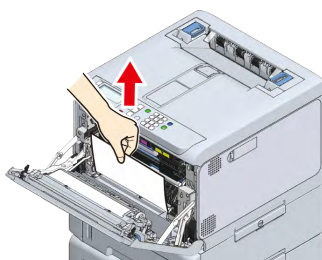

- 6** Pull out the jammed paper slowly if any.

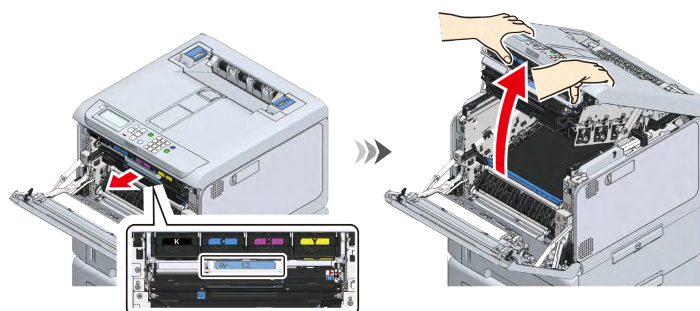

- 7** Pull the L2 lever and lift the output tray until it reaches the stop position.



8 Remove the paper left on the belt unit if any.

 CAUTION	Doing so may cause burns.	
Do not touch the fuser unit because it is hot.		



- Because image drums (green parts) can easily get damaged, handle with adequate care.
- Do not expose the image drum to direct sunlight or strong light (About 1,500 lux or above). Do not leave it uncovered for more than 5 minutes even under room lighting.

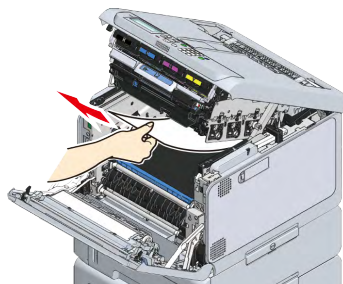

9 Lift the belt unit up by holding its handle.

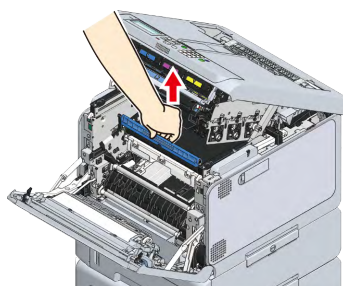

10 Remove the paper left under the belt unit if any.

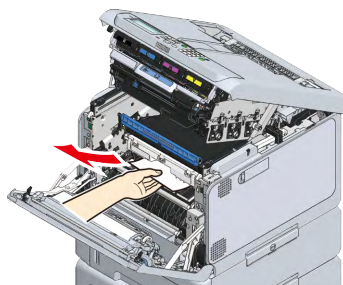

11 Reset the belt unit.

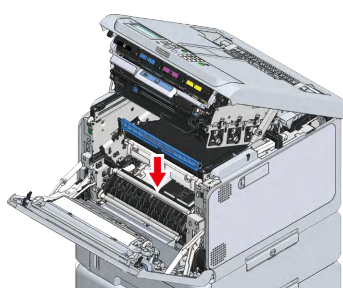

12 Close the output tray, and push both sides down from top.

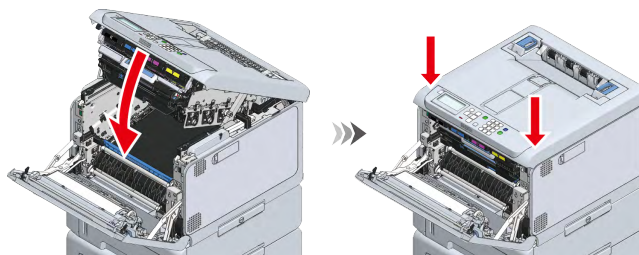



13 Lift the left and right handles of the fuser unit at the back of the output tray until a noise is heard, and then release the lock.

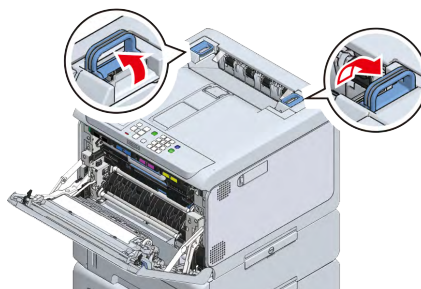

- The fuser unit cannot be removed unless its handle is raised vertically.



14 Holding both the left and right handles of the fuser unit, remove the fuser unit from this machine.

 CAUTION	Doing so may cause burns.	
When the fuser unit is hot, wait until it cools down before any operation.		



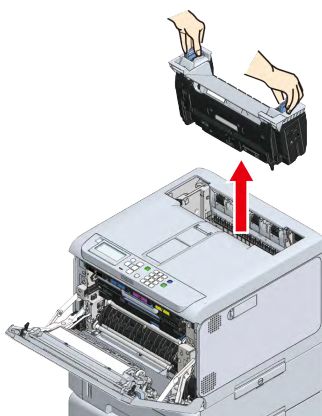

- Do not expose this machine with the fuser unit removed to direct sunlight or strong light (About 1,500 lux or above). Do not leave it uncovered for more than 5 minutes even under room lighting.



15 Remove the paper left in the machine if any.

- 16** If paper is jammed in the fuser unit, with the warning label of the fuser unit facing you, slowly pull out the remaining paper towards you.

 CAUTION	Doing so may cause burns.	
When the fuser unit is hot, wait until it cools down before any operation.		



- Do not pull out in the reverse direction.

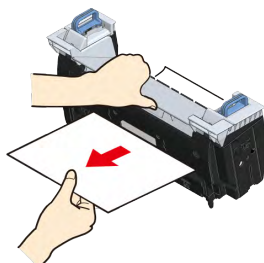

- 17** With the warning label of the fuser unit facing you, hold both the left and right handles.

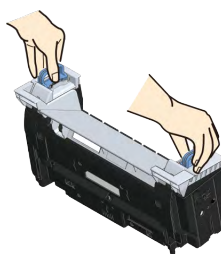

- 18** Place the fuser unit in this machine, tilt its left and right handles inward, and lock the fuser unit.



- Make sure that the fuser unit does not float from the top of the output tray. If floating, the fuser unit will not be recognized so that it is not possible to start printing.

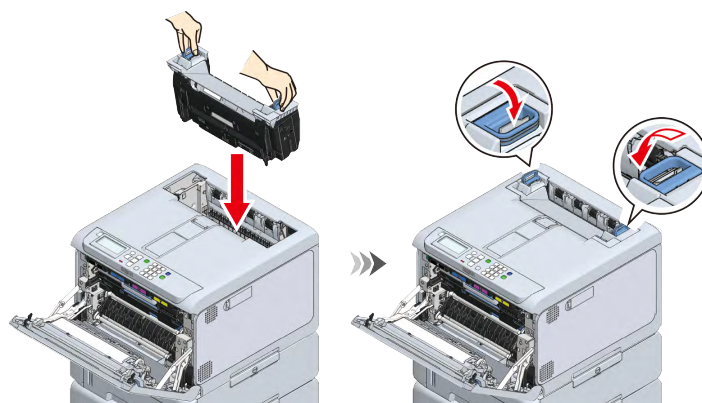

- 19** Close the front cover firmly with both hands.

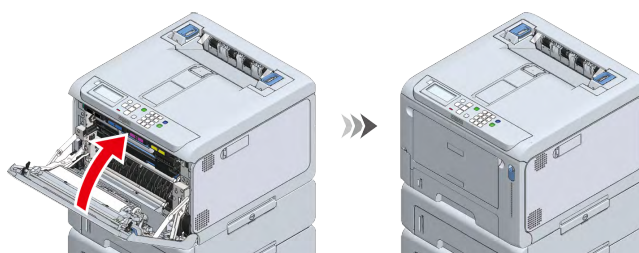

Trouble with printing

This section describes problems with printing from a PC.



- If the problem is not solved using the following explanation, contact your dealer.
- For problems arising from the application, contact the application development company.

I cannot print

For Windows/macOS

Cause	Solution	Reference
This machine powered is off.	Please turn the power on.	Turning the power on(P.71)
The LAN cable/USB cable is disconnected.	Please check that the cable is correctly connected to this machine and the PC.	Connecting via a wired LAN(P.36) Connecting via USB(P.58)
There is a problem with the cable.	Please replace the cable with a new one.	-
This machine is offline.	Press «ON LINE» on the operator panel.	-
An error has occurred to this machine.	Please check the error message displayed on the display. Or, press «HELP» on the operator panel to check and clear the error.	Error message list(P.327)
The interface settings are disabled.	Please check the interface settings you are using on the operator panel.	Connecting via a wired LAN(P.36) Connecting via a wireless LAN(P.41)
The LED lamp of the power switch is flashing rapidly.	This machine is broken. Please remove the power cord immediately and contact your dealer.	-

For Windows

Cause	Solution	Reference
This machine is not set as the default printer.	Set this machine as the default printer. Open the "Devices and Printers", right-click on the [OKI C650 *] icon, and select [Set as Default Printer]. * represents the type of driver. (e.g. PCL6/PS) For Windows 10, uncheck "Let Windows manage my default printer".	-
The printout port of the printer driver is wrong.	Please select the output port to which the LAN cable/USB cable is connected.	-
The printer is set offline on the PC.	Open the "Devices and Printers", right-click on the [OKI C650 *] icon, and select [See what's printing]. When the icons are grouped, select [See what's printing] - [OKI C650 *]. * Represents the type of driver. (e.g. PCL6/PS) In the displayed screen, select the [Printer] menu, and uncheck [Use Printer Offline].	-

Troubleshooting for wired LAN connection

For Windows/macOS

Cause	Solution	Reference
A crossover cable is used.	Use a straight cable.	-
There is a compatibility problem with the hub.	Press the scroll buttons on the operator panel several times to select the proper connection from [Admin Setup] - [Network Setup] - [Wired(LAN1) Setup] - [HUB Link Setting]. See the Instruction Manual supplied with the hub.	-
Wired LAN (LAN1) settings are not appropriate.	Check the wired LAN (LAN1) settings.	Admin Setup(P.118)
Wired LAN settings are not appropriate.	Either the standard wired LAN (LAN1) or wireless LAN is enabled for the gateway address. Select the standard wired LAN (LAN1) from [Admin Setup] - [Network Setup] - [General Setup] - [Enabling Default Gateway].	Admin Setup(P.118)
Depending on the network device you are using, the connection may become unstable if Energy Efficient Ethernet (EEE) of the wired network (LAN1) of this machine is enabled.	Check if the switching hub supports Energy Efficient Ethernet (EEE). If it supports, change [Admin Setup] - [Network Setup] - [Wired (LAN1) Setup] - [Energy Efficient Ethernet] to [Disable] from the web page of this machine and check if it improves.	Web page (Managing this machine from a PC)(P.201)

For Windows

Cause	Solution	Reference
The IP address is incorrect.	<ul style="list-style-type: none"> Make sure the IP address of this machine matches the one set on the PC. Make sure the IP address does not overlap with that of other devices. If [IP Address Set] is set to [Auto], the address may change dynamically. If the setting changes frequently, change [IP Address Set] of this machine to [Manual], and match the IP address of this machine with the one set on the PC. Make sure the configured IP address, subnet mask and gateway address are all correct. Make sure that the print port of the printer driver is correct. For the OKI LPR utility, check the IP address settings with the OKI LPR utility. 	Printing the menu map (configuration)(P. 86) OKI LPR Utility(P.278)
The WSD port is in use.	When the print port does not function well with "WSD", specify the IP address or short printer name of this machine in the standard CP/IP port, and add the print port.	-

Troubleshooting for wireless LAN connection

Unable to connect to wireless LAN

For Windows/macOS

Cause	Solution	Reference
The wireless LAN module is not enabled.	To connect to a wireless LAN, set [Extended Network] to [Wireless].	Connecting via a wireless LAN(P.41)

Cause	Solution	Reference
Settings are not insufficient to connect.	<p>To connect via the wireless LAN access point or the wireless LAN router, set the wireless LAN (Infrastructure) accordingly.</p> <p>To connect a mobile device directly to this machine, set the wireless LAN (AP mode) accordingly.</p>	<p>Connecting via an access point (Infrastructure)(P. 42)</p> <p>Connecting directly with this machine (AP mode)(P.53)</p>
Network connection settings are incorrect.	<ul style="list-style-type: none"> • Wireless LAN (Infrastructure) and Wireless LAN (AP mode) cannot be enabled at the same time. • To connect via a wireless LAN (Infrastructure), set [Wireless(AP Mode)] to [Disable] and [Wireless(Infrastructure)] to [Enable]. • To connect via a wireless LAN (AP mode), set [Wireless(Infrastructure)] to [Disable] and [Wireless(AP mode)] to [Enable]. 	<p>Connecting via a wireless LAN(P.41)</p>
The settings of wireless LAN (Infrastructure) are incorrect.	<p>If you are connected via a wireless LAN (Infrastructure), check the infrastructure settings.</p>	<p>Connecting via an access point (Infrastructure)(P. 42)</p>
The settings of wireless LAN (AP mode) are incorrect.	<p>If you are connected via a wireless LAN (AP Mode), check the AP mode settings.</p>	<p>Connecting directly with this machine (AP mode)(P.53)</p>
A timeout occurs during connection.	<p>Connect by specifying the wireless LAN access point you want to use from the wireless LAN access points detected by this machine.</p>	<p>Connecting by selecting a wireless LAN access point from the operator panel(P.47)</p>

For Windows

Cause	Solution	Reference
The IP address is incorrect.	<ul style="list-style-type: none"> • Make sure the IP address of this machine matches the one set on the PC. • Make sure the IP address does not overlap with that of other devices. • If [IP Address Set] is set to [Auto], the address may change dynamically. If the setting changes frequently, change [IP Address Set] of this machine to [Manual], and match the IP address of this machine with the one set on the PC. • Make sure the configured IP address, subnet mask and gateway address are all correct. • For the OKI LPR Utility, check the IP address settings with the OKI LPR Utility. 	<p>Printing the menu map (configuration)(P. 86)</p> <p>OKI LPR Utility(P.278)</p>
The WSD port is in use.	<p>When the print port does not function well with "WSD", specify the IP address or short printer name of this machine in the standard CP/IP port, and add the print port.</p>	<p>-</p>

Unable to connect to wireless LAN (Infrastructure)

First, print out the Network Information, and then check the following explanation while having a look at items numbered ① to ⑥ in the following figure in Wireless (Infrastructure) Information.

Network Information can be printed from [Print Information] - [Network].

Wireless(Infrastructure) Information			
Network FW Version	03.00	MAC Address	XXXXXXXXXX
① Wireless(Infrastructure)	Enable		
② SSID	AccessPoint1		
③ Security	WPA2-PSK	④ State	Connected
WEP Key Length	64bit	⑤ Band	2.4 GHz (B/G/N)
WEP Key Format	ASCII	BSSID	XXXXXXXXXX
WPA Encryption Type	AES	Channel	1
WPA Pre-shared Key Format	PASSPHRASE	⑥ RSSI	88 %
		Tx Rate	72.0 Mbps

Unable to connect to the access point (State of ④ is not set to "Connected")

Cause	Solution	Reference
[Wireless] is not selected in the [Extended Network] settings.	Select [Admin Setup] - [Network Setup] - [General Setup] - [Extended Network] - [Wireless].	Connecting via an access point (Infrastructure)(P. 42)
The wireless LAN access point does not function properly.	Check that the power of the wireless LAN access point is turned on and it functions properly.	-
[Wireless (Infrastructure)] is set to [Disable].* Above ①	Set [Wireless(Infrastructure)] to [Enable]. *Wireless LAN (Infrastructure) and Wireless LAN (AP mode) cannot be enabled at the same time.	Connecting via an access point (Infrastructure)(P. 42)
[SSID] is incorrect. Or it is blank.* Above ②	Check the SSID of the wireless LAN access point you want to connect is correct, and connect with the correct SSID. If it is blank, the settings for the wireless LAN connection of this machine are insufficient. Set [Wireless(Infrastructure) Setting].	Connecting via an access point (Infrastructure)(P. 42)
The encryption key is incorrect.	Check the encryption key of the wireless LAN access point you want to connect is correct, and set the correct encryption key. When a same number is lined up in the encryption key, be sure to press «OK» after inputting each number. Example: To input 1233, press «1» → «2» → «3» → «OK» → «3». It is incorrect to press «1» → «2» → «3» → «3». In that case, «1»«2»«d» is input, which is not the correct encryption key.	Connecting via an access point (Infrastructure)(P. 42)
The setting of [Security] does not match the security of the wireless LAN access point.* Above ③	Check the security (encryption method) of the wireless LAN access point that you want to connect, and set it to keep consistent.	Connecting via an access point (Infrastructure)(P. 42)

Communication is not stable

Cause	Solution	Reference
The RSSI value is too small.* Above ⑥	The signal strength is insufficient. Put this machine in an unobstructed view position near the wireless LAN access point. (The recommended distance is 30 m or less.) Do not place an electric appliance (especially microwave oven or digital cordless telephone) that emits weak electronic waves near this machine. It may be difficult to connect if there is a metal, aluminum sash or reinforced concrete wall between this machine and the wireless LAN access point.	-
The current frequency band is congested.* Above ⑤	[Band] displays the current frequency band to which this machine is connected. This machine is compatible with the 2.4 Ghz/5.0 GHz band. If the wireless LAN access point is compatible with the 2.4 GHz/5.0 GHz band, try changing the connecting frequency band of the machine (or changing the SSID settings).	Connecting via an access point (Infrastructure) (P. 42)

Able to connect to the access point but unable to communicate

Cause	Solution	Reference
The IP address is in the same segment as the one on the wired side.	Since the communication may be unstable if the wired LAN and wireless LAN are connected to the same subnet, please connect to a different subnet.	-
The setting of the enabled default gateway is wired LAN instead of wireless LAN.	To communicate with a terminal outside the segment via a wireless LAN, press the scroll buttons on the operator panel to select [Admin Setup] - [Network Setup] - [General Setup] - [Enabling Default Gateway] and set it to [Wireless(Infrastructure)]. In that case, the wired LAN cannot communicate with terminals outside the segment. *You can check from [General Information] - [Enabling Default Gateway] in Network Information.	Connecting via an access point (Infrastructure) (P. 42)

Unable to connect to a wireless LAN (AP mode)

First, print out the Network Information, and then check the following explanation while having a look at items numbered ① to ④ in the following figure in Wireless (AP Mode) Information.

Network Information can be printed from [Print Information] - [Network].

Wireless(AP Mode) Information		
① Wireless(AP Mode)	Enable	
② SSID	OKI-C650-123456	
③ Security	WPA2-PSK	
WPA Encryption Type	AES	
Channel	6	④ Number Of Connected 1

Terminals cannot connect

Cause	Solution	Reference
[Wireless] is not selected in the [Extended Network] settings.	Select [Admin Setup] - [Network Setup] - [General Setup] - [Extended Network] - [Wireless].	Connecting directly with this machine (AP mode) (P.53)

Cause	Solution	Reference
[Wireless (AP Mode)] is set to [Disable]. *Above ①	Set [Wireless(AP Mode) Setting] - [Wireless(AP Mode)] to [Enable]. *Wireless LAN (Infrastructure) and Wireless LAN (AP mode) cannot be enabled at the same time.	Connecting directly with this machine (AP mode)(P.53)
[SSID] is not consistent with the SSID selected by the wireless terminal. *Above ②	Check that the SSID of this machine matches the SSID selected by the wireless terminal you want to connect.	Connecting directly with this machine (AP mode)(P.53)
The setting of [Security] is not consistent with that of the wireless terminal. *Above ③	Check that the security of this machine matches the security set for the wireless terminal you want to connect.	Connecting directly with this machine (AP mode)(P.53)
The encryption key is not consistent with that of the wireless terminal.	Check that the encryption key of this machine matches the encryption key set for the wireless terminal you want to connect. You can check from [Wireless(AP Mode) Setting] - [Manual Setup].	Connecting directly with this machine (AP mode)(P.53)
[Number Of Connected] is set to 4.* Above ④	A maximum of 4 terminals can be connected wirelessly (AP mode) to this machine. Terminals exceeding the maximum number cannot be connected. Disconnect other terminals and try to connect again.	Connecting directly with this machine (AP mode)(P.53)

Troubleshooting for USB connection

USB does not connect

For Windows/macOS

Cause	Solution	Reference
The cable does not meet the specifications.	Please use a USB 2.0 cable. The connector type on the machine side is type B.	-
A USB hub is used.	Connect this machine directly to the PC.	Connecting via USB(P.58)
The printer driver is not installed correctly.	Please re-install the printer driver.	Installing software on a PC(P.59)

For Windows

Cause	Solution	Reference
A switch, buffer, extension cable, or USB hub is used.	Connect this machine directly to the PC.	Connecting via USB(P.58)
There are other printer drivers that operate via USB connections.	Remove other printer drivers from the PC.	-





Troubleshooting for printing results







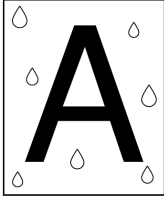

This section describes troubles with printing results.
Click the corresponding symptom to see the solution.









- Please check the following explanation and "Frequently Asked Questions (FAQs)" on your smartphone app or the website.
- If the problem persists, contact your dealer.

List of troubles with printing results

 <p>Paper feed direction</p>	<p>White streaks appear in the vertical direction(P.364)</p>
	<p>Printing is faint in the vertical direction(P.364)</p>
	<p>Printing is light(P.365)</p>
	<p>White dots or lines appear(P.365)</p>
	<p>Condensation occurs on printed paper(P.366)</p>

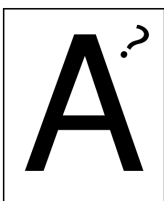
	<p>Streaks appear in the vertical direction(P.366)</p>
	<p>Dots and horizontal streaks appear in the paper feeding direction periodically(P.367)</p>
	<p>White area is lightly stained(P.368)</p>
	<p>Edges of text are blurred(P.368)</p>
	<p>When envelopes or coated paper is printed, the whole area is thinly stained(P.369)</p>
	<p>Toner comes off when rubbed(P.369)</p>
	<p>Uneven Gloss(P.369)</p>
	<p>Point stains appear(P.370)</p>

	<p>Stains are printed(P.370)</p>
	<p>The entire paper is printed in black(P.370)</p>
	<p>Nothing is printed(P.371)</p>
	<p>White streaks occur(P.371)</p>
	<p>The peripheral area is dirty(P.371)</p>
	<p>The color of images does not come as expected(P.372)</p>
 <p>Paper feed direction</p>	<p>An afterimage printed on the front edge of the paper is printed(P.372)</p>

White streaks appear in the vertical direction



Cause	Solution	Reference
The LED head is dirty.	Wipe the LED head with soft tissue paper.	Cleaning the LED head(P.312)
The toner is low.	"Toner Low. " or "Toner Empty. Replace with a new toner cartridge." is displayed, replace the toner cartridge.	Replacing the black(K) toner cartridge and the waste toner box(P.298) Replacing the toner cartridge (C/M/Y)(P.301)
The window film of the image drum is dirty.	Wipe the window film with soft tissue paper.	Cleaning the light-shielding film(P.319)
The image drum has not been installed correctly.	Please install the image drum correctly.	Replacing the image drum(P.303)
A foreign object is stuck in the image drum.	Please replace the image drum.	Replacing the image drum(P.303)

Printing is faint in the vertical direction



Cause	Solution	Reference
The LED head is dirty.	Wipe the LED head with soft tissue paper.	Cleaning the LED head(P.312)
The toner is low.	"Toner Low." or "Toner Is Empty. Replace With A New Toner Cartridge." is displayed, replace the toner cartridge.	Replacing the black(K) toner cartridge and the waste toner box(P.298) Replacing the toner cartridge (C/M/Y)(P.301)
The paper is not supported.	Use recommended paper.	Applicable paper(P.72)

Printing is light



Cause	Solution	Reference
The toner is low.	"Toner Low." or "Toner Empty. Replace with a new toner cartridge." is displayed, replace the toner cartridge.	Replacing the black(K) toner cartridge and the waste toner box(P.298) Replacing the toner cartridge (C/M/Y)(P.301)
The density is not adjusted.	Press the scroll buttons on the operator panel several times to select [Calibration] and run density adjustment.	Adjusting the density manually(P.170)
The paper is moist.	Use the paper stored at appropriate temperature and humidity.	Storing paper(P.83)
The paper is not supported.	Use recommended paper.	Applicable paper(P.72)
The paper is not supported. The media weight is set incorrectly.	Press the scroll buttons on the operator panel several times to select the paper tray you are using from [Menus] - [Tray Configuration], and set an appropriate value for [Media Weight]. Or, change [Media Weight] to a thicker value than the present value.	Setting paper information on the operator panel(P.81)
Recycled paper is used.	Press the scroll buttons on the operator panel several times to select the paper tray you are using from [Menus] - [Tray Configuration], and set a thicker value for [Media Weight].	Setting paper information on the operator panel(P.81)
It is used under an environment where combustion is emitted.	Do not install this machine under an environment where combustion is emitted. If this machine is used under an environment where combustion is emitted indoors such as near an electric or gas stove, the image drum may be degraded.	Installation environment(P.16)

White dots or lines appear



Cause	Solution	Reference
Dry the paper as it is moist.	Use the paper stored at appropriate temperature and humidity.	Storing paper(P.83)

Condensation occurs on printed paper

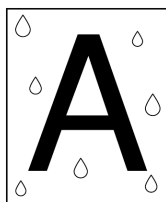

Cause	Solution	Reference
The paper is moist.	Use the paper stored at appropriate temperature and humidity.	Storing paper(P.83)
This machine is used in a place with high humidity or sudden changes in temperature and humidity.	Use this machine in an environment with an appropriate temperature and humidity.	Installation environment(P.16)
The edge of the paper is wet.	Press the scroll buttons on the operator panel several times to select [Menus] - [Print Adjust] - [Moisture Control], and change the setting. This setting may delay the completion of printing the first page.	-

Streaks appear in the vertical direction



Cause	Solution	Reference
The toner is low.	"Toner Low." or "Toner Empty. Replace with a new toner cartridge." is displayed, replace the toner cartridge.	Replacing the black(K) toner cartridge and the waste toner box(P.298) Replacing the toner cartridge (C/M/Y)(P.301)
The image drum is scratched.	Please replace the image drum.	Replacing the image drum(P.303)
Paper guide is misaligned.	Check the position of the paper guide in the paper tray.	Loading paper(P.72)

Dots and horizontal streaks appear in the paper feeding direction periodically

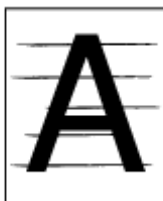

Cause	Solution	Reference
If dots or streaks of a specific color appear at intervals of about 75 mm, the green tube of the image drum is scratched or dirty.	Please replace the image drum.	Replacing the image drum(P.303)
If dots or streaks of various colors appear at intervals of about 94 mm, the fuser unit is scratched or dirty.	Replace the fuser unit.	Replacing the fuser unit(P.310)
If the intervals are about 38 mm, parts inside the belt unit are broken.	Replace the belt unit.	Replacing the belt unit(P.308)
If the intervals are about 34 mm or 43 mm, parts in the image drum are damaged.	Please replace the image drum.	Replacing the image drum(P.303)
If the intervals are about 30 mm, there are foreign objects in the image drum.	Open and close the front cover and print again. If the problem persists, replace the image drum.	Replacing the image drum(P.303)
If the intervals are about 31 mm, the resist roller is dirty.	Open the front cover and wipe the resist roller with soft tissue paper.	Cleaning the resist roller(P.320)
The image drum has been exposed to light.	Install the image drum back to the printer, and leave the printer idle for a few hours. If the problem persists, replace the image drum.	Replacing the image drum(P.303)
Dirt has deposited on the paper transfer path.	Test print a few pages.	Printing the menu map (configuration)(P. 86)

White area is lightly stained



Cause	Solution	Reference
Static electricity occurs to the paper.	Use the paper stored at appropriate temperature and humidity.	Storing paper(P.83)
Thick paper is used.	Use thinner paper.	Loading paper(P.72)
The toner is low.	"Toner Low." or "Toner Empty. Replace with a new toner cartridge."is displayed, replace the toner cartridge.	Replacing the black(K) toner cartridge and the waste toner box(P.298) Replacing the toner cartridge (C/M/Y)(P.301)

Edges of text are blurred



Cause	Solution	Reference
The LED head is dirty.	Gently wipe the LED head with soft tissue paper.	Cleaning the LED head(P.312)
The paper is not supported.	Use recommended paper.	Applicable paper(P.72)
The paper is moist.	Use the paper stored at appropriate temperature and humidity.	Storing paper(P.83)

When envelopes or coated paper is printed, the whole area is thinly stained



Cause	Solution	Reference
When envelopes or coated paper is printed, toner may adhere (cover) to the whole area.	This is not a malfunction. Do not use coated paper as much as possible.	Applicable paper(P.72) Inapplicable paper(P.74)

Toner comes off when rubbed



Cause	Solution	Reference
The media weight is set incorrectly.	Press the scroll buttons on the operator panel several times to select the paper tray you are using from [Menus] - [Tray Configuration], and set an appropriate value for [Media Weight]. Or, change [Media Weight] to a thicker value than the present value.	Setting paper information on the operator panel(P.81)
Recycled paper is used.	Press the scroll buttons on the operator panel several times to select the paper tray you are using from [Menus] - [Tray Configuration], and set a thicker value for [Media Weight].	Setting paper information on the operator panel(P.81)

Uneven Gloss



Cause	Solution	Reference
The media weight is set incorrectly.	Press the scroll buttons on the operator panel several times to select the paper tray you are using from [Menus] - [Tray Configuration], and set an appropriate value for [Media Weight]. Or, change [Media Weight] to a thicker value than the present value.	Setting paper information on the operator panel(P.81)

Point stains appear

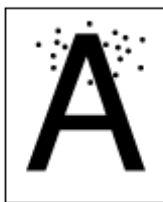

Cause	Solution	Reference
The paper is not supported.	Use recommended paper. If the paper has a lot of paper dust, load the paper after shuffling it well.	Applicable paper(P.72)
If the intervals are approx. 75 mm, the green tube of the image drum is scratched or dirty.	If the image drum is scratched, replace it with a new one.	Replacing the image drum(P.303)

Stains are printed

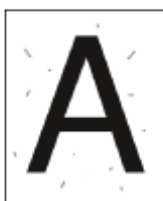

Cause	Solution	Reference
The paper is moist.	Use the paper stored at appropriate temperature and humidity.	Storing paper(P.83)
The paper is not supported.	Use recommended paper.	Applicable paper(P.72)

The entire paper is printed in black



Cause	Solution	Reference
The machine may have broken down.	Please contact your dealer.	-

Nothing is printed

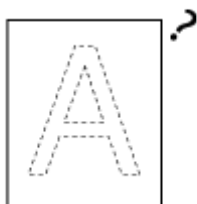

Cause	Solution	Reference
Multiple pages were fed at a time.	Load the paper again after shuffling it well. Clean the paper feed roller.	Loading paper(P.72) Cleaning paper feed rollers (Trays 1-4)(P.314) Cleaning the paper feed roller (MP tray)(P.315)
The machine may have broken down.	Print the menu map and check if the device itself can print. If the menu map cannot be printed correctly, contact your dealer.	Printing the menu map (configuration)(P.86)

White streaks occur

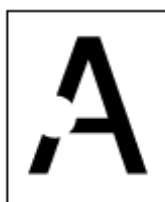

Cause	Solution	Reference
The paper is moist.	Use the paper stored at appropriate temperature and humidity.	Storing paper(P.83)
The paper is not supported.	Use recommended paper	Applicable paper(P.72)

The peripheral area is dirty



Cause	Solution	Reference
The size is not reduced by scale according to the paper size.	Reduce the size by scale according to the paper size.	Enlarging/Reducing to fit the specified media size(P.152)

The color of images does not come as expected

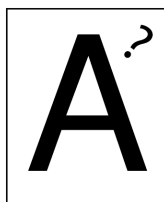

Cause	Solution	Reference
The toner is low.	When "Toner Low." or "Toner Empty. Replace with a new toner cartridge." is displayed, replace the toner cartridge.	Replacing the black(K) toner cartridge and the waste toner box(P.298)
The setting of [Black Finish] is not suitable for the application.	In [Black Finish] of the printer driver, select [Composite Black (CMYK)] or [True Black (K)].	Screens and functions of the printer driver(P.133)
Color tuning has been changed.	Perform color matching in the printer driver.	Color matching in the printer driver(P.167) Simulating print results(P.168)
Color balance is not adjusted.	Press the scroll buttons on the operator panel several times to select [Calibration], adjust density, or adjust the color balance.	Adjusting the density manually(P.170) Adjusting the color balance (density)(P.170)
Color misregistration is not corrected.	Open and close the front cover. Or, press the scroll buttons on the operator panel several times to select [Calibration] - [Adjust Registration].	Adjusting registration manually(P.169)

An afterimage printed on the front edge of the paper is printed



Cause	Solution	Reference
If an afterimage is printed under about 94 mm, the media weight may not be set correctly.	Press the scroll buttons on the operator panel several times to select the paper tray you are using from [Menus] - [Tray Configuration], and set an appropriate value for [Media Weight]. Or, change [Media Weight] to a thinner value than the present value.	Setting paper information on the operator panel(P.81)
If an afterimage is printed at an interval of about 94 mm, the fuser unit may be scratched or dirty.	Replace the fuser unit.	Replacing the fuser unit(P.310)

Software troubleshooting



- Monitoring Tool
 - [Troubleshooting \(Monitoring Tool\)\(P.254\)](#)

Troubleshooting for this machine and paper

Troubleshooting for the machine

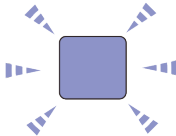

- Please check the following explanation and "Frequently Asked Questions (FAQs)" on the website or your smartphone application.
- If the problem persists, contact your dealer.

Symptom	Cause	Solution	Reference
Nothing is displayed even after the power is turned on.	The power cord is disconnected.	Firmly insert the power cord.	-
	There is a power failure.	Check the power transmission status to the outlet.	-
It does not work.	The power cord is not inserted firmly.	Firmly insert the power cord.	-
	The power is not turned on.	Please turn the power on.	Turning the power on(P.71)
	The power was turned off by the Auto Power Off function.	Please turn the power on. Or, disable the auto power off function.	Turning off the power automatically (Auto Power Off)(P.99)
	This machine is frozen.	Press and hold the power switch for more than 5 seconds to force a shutdown.	-
The LED lamp of the power switch is flashing rapidly at intervals of approx. 0.3 seconds. 	This machine is broken.	Please remove the power cord immediately and contact your dealer. 	-
The output tray does not close.	The belt unit is not inserted properly.	Install the belt unit again.	Replacing the belt unit(P.308)
	The image drum basket is not inserted to the end.	Insert the image drum basket to the end.	Replacing the image drum(P.303)
The front cover does not close. (The L1 lever dose not move.)	The image drum is not installed.	Insert the image drum by pulling the L2 lever and opening the output tray.	Replacing the image drum(P.303)
The error is not cleared even after the toner or drum is replaced.	The replaced consumables are not correct.	Check the name and color of the consumables that must be replaced by the error message on the display. Replace the corresponding consumables.	Error message list(P.327) Replacing the black(K) toner cartridge and the waste toner box(P.298)
	The toner cartridge is not installed properly.	Check that the toner cartridge is installed firmly.	Replacing the toner cartridge (C/M/Y)(P.301)

Symptom	Cause	Solution	Reference
Printing process does not start.	An error is displayed.	Check the error code and follow the on-screen instructions.	Error message list(P.327)
	The LAN/USB cable is not plugged in.	Firmly insert the LAN/USB cable.	Connecting via a wired LAN(P.36)
	There is a problem with the LAN/USB cable.	Use another LAN/USB cable.	-
	The LAN cable does not meet the specifications.	Please use the cable of Ethernet 10BASE-T/100BASE-TX/1000Base specifications.	-
	The USB cable does not meet the specifications.	Please use the USB cable enclosed with this machine.	-
	There may be a problem with the print function.	Press the scroll buttons on the operator panel to select [Print Information] - [Configuration], and print the configurations to check the printing performance.	Printing the menu map (configuration)(P. 86)
	The communication protocol is disabled.	Press the scroll buttons on the operator panel to select [Admin Setup] - [Network Setup] and enable the communication protocol in use.	-
	The printer driver is not selected.	Open the "Devices and Printers". Right-click on the icon of this machine, and select "Set as Default Printer".	How to open the printer folder(P.142)
	The output port of printer driver is incorrect.	Specify the output port to connect the LAN/USB cable.	-
Nothing is displayed.	This machine is in the sleep mode.	Check that «POWER SAVE» is blinking, and press «POWER SAVE» to start this machine.	-
The print data is not sent.	The LAN/USB cable is broken.	Connect with a new cable.	-
	The PC has timed out.	Increase the length of timeout in port settings of the PC.	-
An abnormal sound is heard.	This machine is tilted.	Install it on a stable and flat surface.	-
	Paper dust or foreign objects are left inside this machine.	Check the inside of this machine and remove the object if any.	-
	The output tray is open.	Close the output tray.	-
A resonant sound is heard.	While the temperature inside this machine is rising, printing is done on narrow or thick paper.	This is not a fault with this machine. Use it as it is.	-
Printing does not start immediately.	This machine is warming up for recovering from the power save mode or sleep mode.	Extend the time that will elapse before the power save mode or sleep mode is entered by the following procedure. Press the scroll buttons on the operator panel to select [Power Save Time] or [Sleep Time] from [Menus] - [System Adjust].	Setting the power save function(P.98)

Symptom	Cause	Solution	Reference
Printing stops in between.	The temperature is adjusted because the temperature inside this machine has risen due to long-time continuous printing.	Please wait. The printing will automatically start again once the temperature of this machine returns appropriate.	-
The memory is insufficient.	The memory of this machine is insufficient as the print data is too big.	Print again after reducing the resolution in the printer driver.	-
All pages are not printed.	The WSD port is used.	Change the print destination port to the standard TCP/IP port.	-
Printing, printer search or setup is not available in the sleep mode.	The NBT/WINS protocol is suppressed in the sleep mode.	Press the scroll buttons on the operator panel to select [Specific] from [Admin Setup] - [USB Setup] - [Connected Host].	-
Periodic email alerts are not notified in the sleep mode.	Periodic email alerts notification is suppressed in the sleep mode.	Press the scroll buttons on the operator panel to select [Specific] from [Admin Setup] - [USB Setup] - [Connected Host].	-
The time and date settings of this machine may be shifted if acquired from the server.	The time update function with the SNTP server is suppressed in the sleep mode.	Press the scroll buttons on the operator panel to select [Specific] from [Admin Setup] - [USB Setup] - [Connected Host].	-
Printing is slow.	Printing is also performed on the PC side.	Use a PC with a fast processing speed.	-
	In [Print Options] tab of the printer driver, [Extra Fine (Multi-Tone)] or [Fine (1200x1200dpi)] is selected.	Select [Normal (600x600dpi)] in the [Preferences] or [Print Options] tab of the printer driver.	-
	The print data is complicated.	Select simple print data.	-
	Narrow paper (less than 182 mm) is used.	Press the scroll buttons on the operator panel to select [Menus] - [Print Adjust] - [Narrow Paper Speed], and change the setting.	-
	When moisture control is set to [Mode1] or [Mode2], it may take more time to print and output the first page.	Press the scroll buttons on the operator panel to select [Off] in [Menus] - [Print Adjust] - [Moisture Control].	-
Display of the printer driver is abnormal.	The printer driver may not work correctly.	Delete and reinstall the printer driver.	Deleting software(P.322) Installing software(P.247)

Symptom	Cause	Solution	Reference
The power turns off automatically.	If this machine has not been used for a certain period of time (whose factory default setting is 4 hours), the power will turn off automatically. This function is called Auto Power Off.	Press the scroll buttons on the operator panel to select [Admin Setup] - [Power Setup] - [Auto Power Off] - [Disable].	Turning off the power automatically (Auto Power Off)(P.99)
The web page does not open.	[Web] is set to [Disable] in the menu of this machine.	Press the scroll buttons on the operator panel to select [Enable] in [Admin Setup] - [Network Setup] - [General Setup] - [Web].	-
	The IP address is incorrect.	Check the IP address of this machine and correct it if needed.	Printing the menu map (configuration)(P. 86)
	The LAN cable is disconnected.	Check connection of the LAN cable.	Connecting the LAN cable(P.36)
"Yellow Toner Cartridge Is Not Installed Correctly/Reset It Correctly. (Error Code: 544)" is repeatedly displayed.	Toner consumption is high, and it is being used in a condition where the supply from the toner cartridge is insufficient.	Change the settings to the following: Moisture Control: Mode 2; Quiet Mode: On. To print with low toner consumption, please restore the settings. (The factory default settings are as follows: Moisture Control: Off; Quiet Mode: Off)	Menu list(P.102)

Troubleshooting for the paper



- Please check the following explanation and "Frequently Asked Questions (FAQs)" on the website or your smartphone application.
- If the problem persists, contact your dealer.

Symptom	Cause	Solution	Reference
<ul style="list-style-type: none"> • Paper jams occur frequently. • Multiple sheets of paper are pulled in simultaneously. • The paper is pulled in an inclined direction. 	This machine is tilted.	Install it on a stable and flat surface.	-
	The paper is either too thin or too thick.	The paper is either too thin or too thick. Use the paper applicable to this machine.	Applicable paper(P.72)
	The paper is moist or charged with static electricity.	Use the paper stored at appropriate temperature and humidity.	Storing paper(P.83)
	The paper is wrinkled, folded or curled.	Use the paper applicable to this machine. Straighten the paper if it is curled.	Applicable paper(P.72)
	The paper has had its reverse side printed.	Already printed paper cannot be printed again from Tray 1/2/3/4. Print from the MP tray.	-
	The paper is not aligned yet.	Shuffle the paper well, and load the paper with the top, bottom, left and right aligned.	Loading paper(P.72)
	Load only one sheet of paper.	Load multiple sheets of paper.	-
	Additional paper is loaded in the tray while the existing paper is kept as it is.	Remove the existing paper in the tray, and load the paper again together with the new one with the top, bottom, left and right aligned.	Loading paper(P.72)
	The paper is not loaded straight.	Align the paper with the paper guide and paper stopper of Tray 1/2/3/4. Align the paper with the manual feeder guide of the MP tray.	Loading paper(P.72)
	The envelope is loaded in a wrong orientation.	Load the envelope again correctly.	Loading paper(P.72)
	Envelopes are stucked together.	Shuffle the envelopes well, or stack them one by one.	-
	Load paper with a paper weight of 221-256 g/m ² , envelope or labels in Tray 1/2/3/4.	Load paper with a paper weight of 221-256 g/m ² , envelope or labels in the MP tray.	Paper applicable to each tray(P.76)
	The rear output tray is not closed properly.	Firmly close the rear output tray.	Setting the output bin(P.84)
Paper jams occur frequently.	The paper feed roller is dirty with paper dust.	Clean the paper feed roller.	Cleaning paper feed rollers (Trays 1-4)(P.314) Cleaning the paper feed roller (MP tray)(P.315)
Paper cannot be fed.	[Paper Source] in the printer driver is selected incorrectly.	Check the paper tray, and select the correct tray from [Paper Source] in the printer driver.	-
	Manual feeding is specified in the printer driver.	Disable [Feed paper individually] in the printer driver.	Printing one sheet at a time manually(P.151)

Symptom	Cause	Solution	Reference
Paper cannot be fed from Tray 2/3/4	Tray 2/3/4 is not set up in the printer driver.	Set up Tray 2/3/4 in the printer driver.	Setting the printer driver(P.64)
The machine is not restored even after the jammed paper is removed.	-	Open and close the front cover.	-
The paper gets curled. The paper is waved. The paper is wrinkled.	The paper is moist or charged with static electricity.	Use the paper stored at appropriate temperature and humidity.	Storing paper(P.83)
	Thin paper is used.	Press the scroll buttons on the operator panel to select [Menus] - [Tray Configuration] - [(Tray Name) Config] - [Media Weight]. Then, change the current setting to a thinner value.	Setting paper information on the operator panel(P.81)
The paper gets curled. The paper is waved.	Thin paper is used.	Press the scroll buttons on the operator panel to select [Menus] - [Print Adjust] - [High Humid Mode], and change the setting.	-
The paper twines around the inside of the fuser.	The media weight is set incorrectly.	Press the scroll buttons on the operator panel to set an appropriate value in [Menus] - [Tray Configuration] - [(Tray Name) Config] - [Media Weight]. Or, change [Media Weight] to a thicker value than the present one.	Setting paper information on the operator panel(P.81)
	Thin paper is used.	Use thicker paper.	-
	There is near-solid filling at the top edge of the paper.	Try leaving a margin at the top edge of the paper. With duplex printing, try leaving a margin at the rear edge of the paper.	-
The paper winds around the belt unit.	Thin or soft paper is used.	Use thicker paper. For A5 size, change the orientation of the paper.	-
Corners of the paper are folded (the edge is folded).	The paper is curled. The paper is waved.	Use the paper stored at appropriate temperature and humidity.	Storing paper(P.83)
The envelope is wrinkled.	The paper is moist.	Use the paper stored at appropriate temperature and humidity.	Storing paper(P.83)
	This machine is being used in high temperature and humidity.	Press the scroll buttons on the operator panel to select a mode (Mode1, Mode2 or Off) from [Menus] - [Print Adjust] - [High Humid Mode].	Menu list(P.102)
	If the problem persists	Load the envelope with the flap facing the main unit. Next, from Print Setup, set the orientation to 180° reversion.	Screens and functions of the printer driver(P.133)
Misalignment occurs when paper is output from the expansion tray.	Misalignment occurs with each tray.	Press the scroll buttons on the operator panel to select the tray to adjust in [Menus] - [Print Adjust] - [Print Position Adjust], and correct the value of [X Adjust] (Landscape) or [Y Adjust] (Portrait).	Correcting the print position of the tray(P.189)
The edge of the paper is wet.	Wet paper is used.	Press the scroll buttons on the operator panel to select [Menus] - [Print Adjust] - [Moisture Control], and change the setting.	-

Symptom	Cause	Solution	Reference
The paper is automatically fed from another paper tray when the paper tray runs out of paper during printing.	Tray Switch is set to Auto.	Change the Auto Tray Switch setting in the printer driver. For the Windows PCL printer driver, uncheck [Setup] - [Paper Feed Options] - [Paper feed options] - [Auto Tray Change]. For the Windows PS printer driver, uncheck [Layout] - [Advanced] - [Printer Features] - [Tray Switch] - [Off]. For macOS, go to [Paper Feed] - [All Pages From] to select the tray to be used.	Screens and functions of the printer driver(P.133)

When a power failure occurs

If a power failure occurs while the power is on, the power will not turn on automatically even after the power failure is recovered.

If you want the power to turn on automatically after the power failure is recovered, select [Always On] or [Last State] in [Boot Menu] - [After AC power supply fails].

[Boot Menu\(P.129\)](#)



- The machine may not work properly if an uninterruptible. power supply (UPS) or inverter is used. Do not use any uninterruptible. power supply or inverter.

With the factory default settings, when a power failure occurs, this machine acts as follows.

State of this machine	Action
Receiving	Reception is interrupted halfway.
Printing a report	Report printing is interrupted halfway.
Standby	Printing cannot be started.

Appendix

Specifications	382
Dimensions.....	386
Using the FAQ guide of this machine.....	388
Contact us	391
Menu tree	392

Specifications

Model	Model Number
C650, ES6450	N36800A, N36800B

General specifications

Item	C650/ES6450	
CPU	ARM processor (667 MHz)	
Memory	Built-in	DDR3 32bit 1GB
Weight (with consumables)	Approx. 28 kg	
Dimensions (WxDxH)	395 × 430 × 290 mm	
Power	N36800A: 110V - 127V AC +/-10% N36800B: 220V - 240V AC +/-10%	
Power consumption (of the main unit only)	Operating	840 W
	Standby	20 W (Average)
	Peak	1,150 W
	Power save mode	Less than 14 W
	Sleep mode	N36800A: Less than 0.8W*1 N36800B: Less than 1.1W*1
Operating environment conditions	Operating	Temperature: 10°C - 32°C; Humidity: 20% - 80% RH
	Pause	Temperature: 0°C - 43°C; Humidity: 10% - 90% RH
Interface	USB 2.0, Ethernet 10BASE-T/100BASE-TX/1000BASE-T, USB 2.0 Host, IEEE802.11 a/b/g/n Wireless LAN	
Display screen	2.9-inch monochrome graphic panel, 320 x 128 dots	
Compatible OS	Windows 10/Windows 8.1/Windows 8/Windows 7 Windows Server 2019/Windows Server 2016/Windows Server 2012 R2/Windows Server 2012/Windows Server 2008 R2/Windows Server 2008 macOS X 10.11 - 10.15	
Service life*2	5 years or 600,000 sheets	
Storage environment	Temperature: -10°C - 43°C Relative humidity: 10% - 90%	

*1: The default setting. It may vary with the specific settings.

*2: The service life of this machine depends on the specific usage.

Printing specifications

Item	C650/ES6450
Print method	The method of dry electrophotographic recording using LED (light-emitting diode) as exposure light source
Page description language	PCL6 (XL3.0), PCL5c, IBM5577 (H02), PostScript3, PDF (v2.0)
Resident	PCL: European 91 fonts, Japanese 4 fonts PS: European 80 fonts, Japanese 2 fonts
Resolution	600 x 600 dpi, 1200 x 1200 dpi
Print colors	Yellow, Magenta, Cyan, Black
Printing speed (A4, Portrait)	Color/Mono Simplex printing: 35 ppm Duplex printing: 18 ppm

Item		C650/ES6450
First page output time	Color	Approx. 6.5 sec (A4)
	Mono	Approx. 6.5 sec (A4)
Media Size	Tray 1	A4, A5, A6, B5, B6, Letter, Legal 13/13.5/14, Executive, Statement, 8.5-inch SQ, Folio, 16K (197 x 273 mm, 195 x 270 mm, 184 x 260 mm), 5 x 7 inches, custom sizes
	Expansion tray unit (Optional)	A4, A5, A6, B5, B6, Letter, Legal 13/13.5/14, Executive, Statement, 8.5-inch SQ, Folio, 16K (197 x 273 mm, 195 x 270 mm, 184 x 260 mm), 5 x 7 inches, custom sizes
	MP Tray	A4, A5, A6, B5, B6, B6 Half, B7, B8, Letter, Legal 13/13.5/14, Executive, Statement, 8.5-inch SQ, Folio, Index Card (3 x 5 inches), 4 x 6 inches, 5 x 7 inches, Long scale (max: 1321 mm), 16K (197 x 273 mm, 195 x 270 mm, 184 x 260 mm), C5, DL, Com-9, Com-10, Monarch, custom sizes
	Duplex printing	A4, A5, A6, B5, B6, Letter, Legal 13/13.5/14, Executive, Statement, 8.5-inch SQ, Folio, 16K (197 x 273 mm, 195 x 270 mm, 184 x 260 mm), 5 x 7 inches, custom sizes
	Custom size	<ul style="list-style-type: none"> · Tray 1 100 - 216 mm (W), 148 - 356 mm (L) · Expansion tray unit 105 - 216 mm (W), 148 - 356 mm (L) · MP tray 55 - 216 mm (W), 91 - 1321 mm (L) · Duplex 105 - 216 mm (W), 148 - 356 mm (L)
Paper quality	Plain (60 g/m ² - 256 g/m ²), Envelope, Label	
Paper feeding method	Auto paper feeding from Tray 1, the MP tray and the expansion tray unit (Optional) Manual feeding from the MP tray	
Feeding capacity	<ul style="list-style-type: none"> · Tray 1 250 sheets (80 g/m²), with the total weight of 25 mm or less · MP tray 100 sheets (80 g/m²), with the total weight of 10 mm or less; 10 envelopes (GSM paper weight: 85 g/m²) · Expansion tray unit Plain: 530 sheets (80 g/m²), with the total weight of 53 mm or less 	
Paper output method	Output tray, rear output tray	
Output capacity	<ul style="list-style-type: none"> · Output tray Plain: 150 sheets (80 g/m²) · Rear output tray Plain: 100 sheets (80 g/m²) 	
Assured printing range	6.35 mm or more from the edge of the paper (except for special paper like envelopes)	
Printing accuracy*1	Writing position accuracy: ±2 mm (±3 mm for the bottom tray when 3 expansion trays are installed); paper slant: ±1 mm/100 mm Image stretch: ±1 mm/100 mm (80 g/m ²)	
Warm-up time	<ul style="list-style-type: none"> · Power-on Approx. 20 sec or less (At room temperature 25°C and rated voltage) · When Power Save enabled Approx. 11 sec or less (At room temperature 25°C and rated voltage) Approx. 13 sec or less only for Taiwan-oriented models (At room temperature of 25°C and rated voltage) 	

Item	C650/ES6450
Print quality assurance conditions	<ul style="list-style-type: none"> · Operating range Temperature: 10°C; Humidity: 20% - 80% RH Temperature: 32°C; Humidity: 20% - 60% RH Humidity: 30% RH; Temperature: 10°C - 32°C Humidity: 80% RH; Temperature: 10°C - 27°C · Full color printing quality assurance range Temperature: 17°C - 27°C; Humidity: 50% - 70% RH
Consumables	Toner cartridge, image drum
Maintenance parts	Belt unit, fuser unit

*1: Standard-sized paper

Specifications of the expansion tray unit

Item	Expansion tray unit
Weight	Approx. 6.0 kg
Dimensions	395 mm (W) x 450 mm (D) x 139 mm (H)

Network specifications

Item	C650/ES6450
Interface	Ethernet 10BASE-T/100BASE-TX/1000BASE-T, IEEE 802.11a/b/g/n Wireless LAN
Protocol	TCP/IPv4, TCP/IPv6, NetBIOS over TCP, LPR, Port9100, IPP, FTP, HTTP, TELNET, SMTP, POP3, SNMPv1/v3, DHCP, DHCPv6, DNS, DDNS, WINS, Bonjour, SNTP, LLTD, Web Services for Devices (WSD), SSL/TLS, IPSec, LDAPv3, Kerberos, IEEE802.1X, AirPrint, HTTPS, SMTPS, POP3S, IPPS, FTPS, LDAPS

Wireless LAN specifications

Item	C650/ES6450
Wireless LAN standard	IEEE802.11a/b/g/n compliant (2.4 GHz/5 GHz)
Security	Disabled, WEP, WPA-PSK, WPA2-PSK, WPA-EAP, and WPA2-EAP

Regulatory wireless LAN statements

- FCC Statement
- IC Statement
- Europe-CE Declaration of conformity.

FCC statement

FCC WARNING

Changes or modifications not expressly approved by the party responsible for compliance could void the user's authority to operate the equipment.

Note: This equipment has been tested and found to comply with the limits for a Class B digital device, pursuant to part 15 of the FCC Rules. These limits are designed to provide reasonable protection against harmful interference in a residential installation. This equipment generates, uses and can radiate radio frequency energy and, if not installed and used in accordance with the instructions, may cause harmful interference to radio communications. However, there is no guarantee that interference will not occur in a particular installation. If this equipment does cause harmful interference to radio or television reception, which can be determined by turning the equipment off and on, the user is encouraged to try to correct the interference by one or more of the following measures:

- Reorient or relocate the receiving antenna.
- Increase the separation between the equipment and receiver.
- Connect the equipment into an outlet on a circuit different from that to which the receiver is connected.
- Consult the dealer or an experienced radio/TV technician for help.

This transmitter must not be co-located or operating in conjunction with any other antenna or transmitter.

IC statement

This device complies with Part 15 of FCC Rules and Industry Canada licence-exempt RSS standard(s). Operation is subject to the following two conditions: (1) this device may not cause interference, and (2) this device must accept any interference, including interference that may cause undesired operation of this device.

Le présent appareil est conforme aux la partie 15 des règles de la FCC et CNR d'Udustrie Canada applicables aux appareils radio exempts de licence. L'exploitation est autorisée aux deux conditions suivantes : (1) l'appareil ne doit pas produire de brouillage, et (2) l'utilisateur de l'appareil doit accepter tout brouillage radioélectrique subi, même si le brouillage est susceptible d'en compromettre le fonctionnement.

This Class [B] digital apparatus complies with Canadian ICES-003.

Cet appareil numérique de la classe [B] est conforme à la norme NMB-003 du Canada.

Caution (FCC/IC):

5.15-5.25 GHz band is restricted to indoor operations only.

La bande 5150-5250 MHz est restreints à une utilisation à l'intérieur.

This equipment complies with FCC/IC radiation exposure limits set forth for an uncontrolled environment and meets the FCC radio frequency (RF) Exposure Guidelines and RSS-102 of the IC radio frequency (RF) Exposure rules. This equipment should be installed and operated keeping the radiator at least 20 cm or more away from person's body.

Cet équipement est conforme aux limites d'exposition aux rayonnements énoncées pour un environnement non contrôlé et respecte les règles les radioélectriques (RF) de la FCC lignes directrices d'exposition et d'exposition aux fréquences radioélectriques (RF) CNR-102 de l'IC. Cet équipement doit être installé et utilisé en gardant une distance de 20 cm ou plus entre le dispositif rayonnant et le corps.

Europe - CE Declaration of Conformity



This equipment complies with the essential requirements of the European Union directive 2014/53/EU.

The telecommunications functionality of this product may be used in the following EU and EFTA countries: Austria, Belgium, Bulgaria, Cyprus, Czech Republic, Denmark, Estonia, Finland, France, Germany, Greece, Hungary, Iceland, Ireland, Italy, Latvia, Liechtenstein, Lithuania, Luxembourg, Malta, Netherlands, Norway, Poland, Portugal, Romania, Slovak Republic, Slovenia, Spain, Sweden, Switzerland, Turkey and United Kingdom.

Dimensions

Plan view

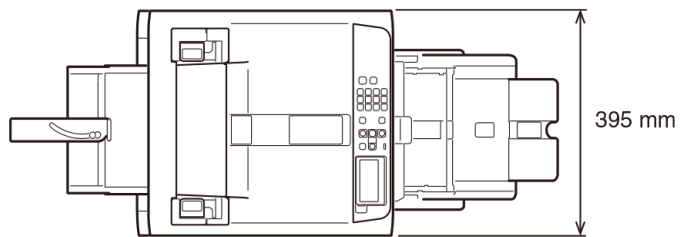

Side view

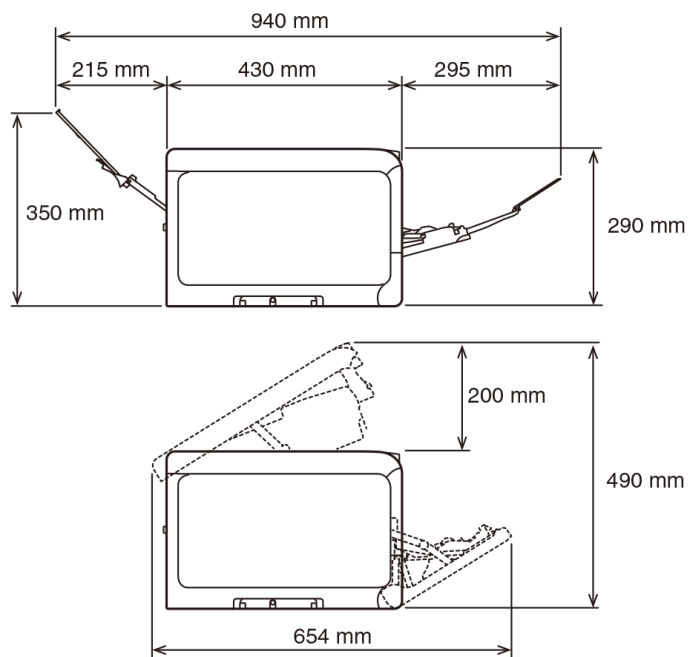

With options installed

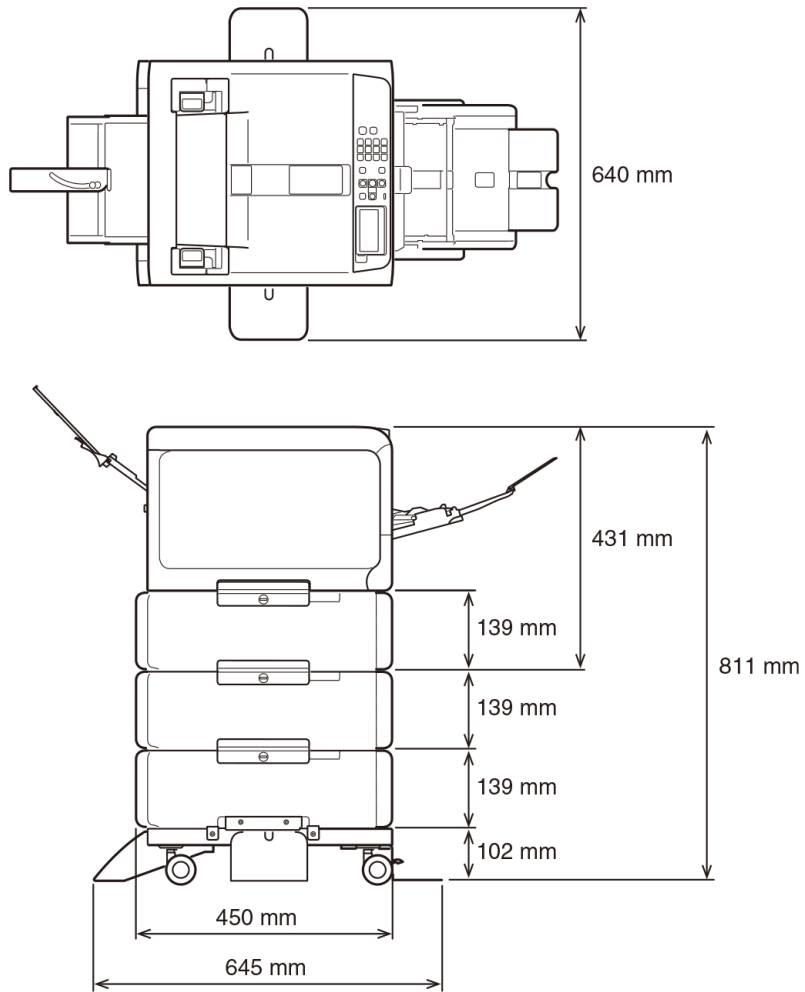

Using the FAQ guide of this machine

If an error occurs in this machine, you can search for a solution by accessing the "Frequently Asked Questions (FAQs)" on the website from the mobile device application or the FAQ on your PC.

You can also easily find a solution by inputting the keyword in "Search Keyword" displayed on this machine.

How to display "Search Keyword"

If an error occurs in this machine (when «ATTENTION» on the operator panel blinks or lights on) and [Please See HELP For Details] appears on the display, press «HELP» on the operator panel to display "Search Keyword".

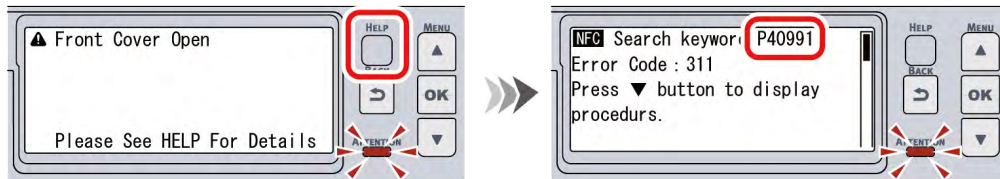

From your mobile device

- 1 Install the Mobile Print application.

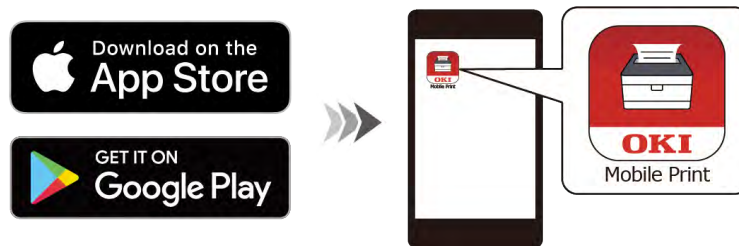

- 2 Tap to launch the application, and tap [FAQ].
- 3 Select your machine from the product selection screen.
- 4 Input the keyword in "Search Keyword" displayed on this machine to search for a solution.



- You can also narrow the search by category or by inputting other keywords.

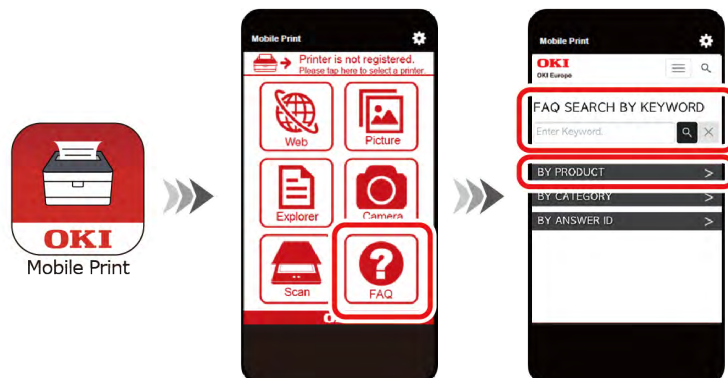

- 5 If "NFC" appears on this machine's display, bring the mobile device where the Mobile Print app is running close to the NFC mark on the operator panel, and "FAQ" will start and display the result of the search for the solution page.



- If you are using iOS, tap [NFC] to display [Ready to Scan] and then move the mobile device close to this machine.

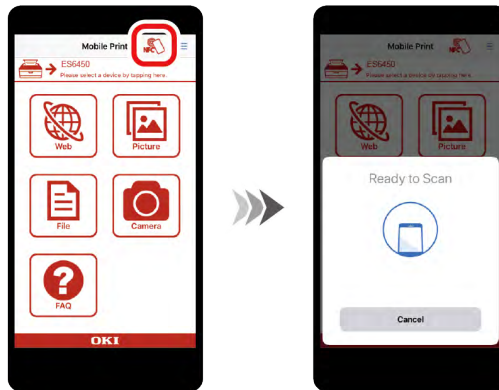

- This function is available to the NFC-compatible device with Mobile Print installed.
- Enable the NFC function on your mobile device.
- Check that the NFC setting of this machine is enabled. The factory default setting is [Enable].

From your PC

For Windows

- 1 Install the FAQ.

If you install the software using [Recommended Install] or [Batch Install], the FAQ will be installed.

Else you can install it using [Individual Install].

You can also install it from the website.



- Refer to "[Installing software on a PC\(P.59\)](#)" for the installation method.

- 2 Open the FAQ icon located on the desktop.
- 3 Select your machine from the product selection screen.

- 4 Input the keyword in "Search Keyword" displayed on this machine to search for a solution.



- You can also narrow the search by category or by inputting other keywords.

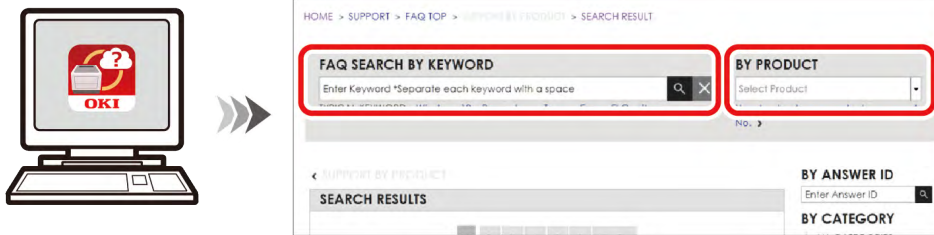

For macOS

- 1 Install the FAQ.
Copy the FAQ from the enclosed DVD to your desktop.
You can also install it from the website.
- 2 Open the FAQ icon located on the desktop.
- 3 Select your machine from the product selection screen.
- 4 Input the keyword in "Search Keyword" displayed on this machine to search for a solution.



- You can also narrow the search by category or by inputting other keywords.

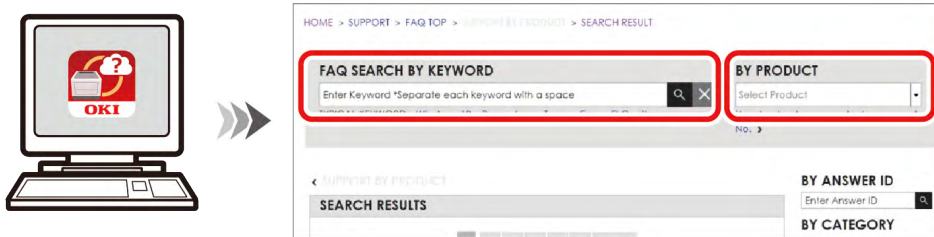

Contact us

Italia	www.oki.com/it
Français	www.oki.com/fr
Deutschland	www.oki.com/de
United Kingdom	www.oki.com/uk
Ireland	www.oki.com/ie
España	www.oki.com/es
Portuguesa	www.oki.com/pt
Sverige	www.oki.com/se
Danmark	www.oki.com/dk
Norge	www.oki.com/no
Suomi	www.oki.com/fi
Nederland	www.oki.com/nl
België/Belgique	www.oki.com/be
Österreich	www.oki.com/at
Schweiz/Suisse/Svizzera	www.oki.com/ch
Polska	www.oki.com/pl
Česká	www.oki.com/cz
Slovenská	www.oki.com/sk
Magyarország	www.oki.com/hu
Россия	www.oki.com/ru
Україна	www.oki.com/ua
Türkiye'ye	www.oki.com/tr
Serbia	www.oki.com/rs
Croatia	www.oki.com/hr
Greece	www.oki.com/gr
Romania	www.oki.com/ro
OKI Europe	www.oki.com/eu
Singapore	www.oki.com/sg/
Malaysia	www.oki.com/my/
ประเทศไทย	www.oki.com/th/printing/
Australia	www.oki.com/au/
New Zealand	www.oki.com/nz/
中国	www.oki.com/cn/printing
대한민국	www.oki.com/kr/
United States	www.oki.com/us/
Canada	www.oki.com/ca/
Brasil	www.oki.com/br/printing
México	www.oki.com/mx/
Argentina	www.oki.com/la/
Colombia	www.oki.com/la/
Other countries	www.oki.com/printing/

Menu tree

